



It is highly recommended that you visit www.metalearth.com/360/icx127 to see the completed model before assembling your own

METAL SHEETS

Parts that are in the same color are duplicates

A

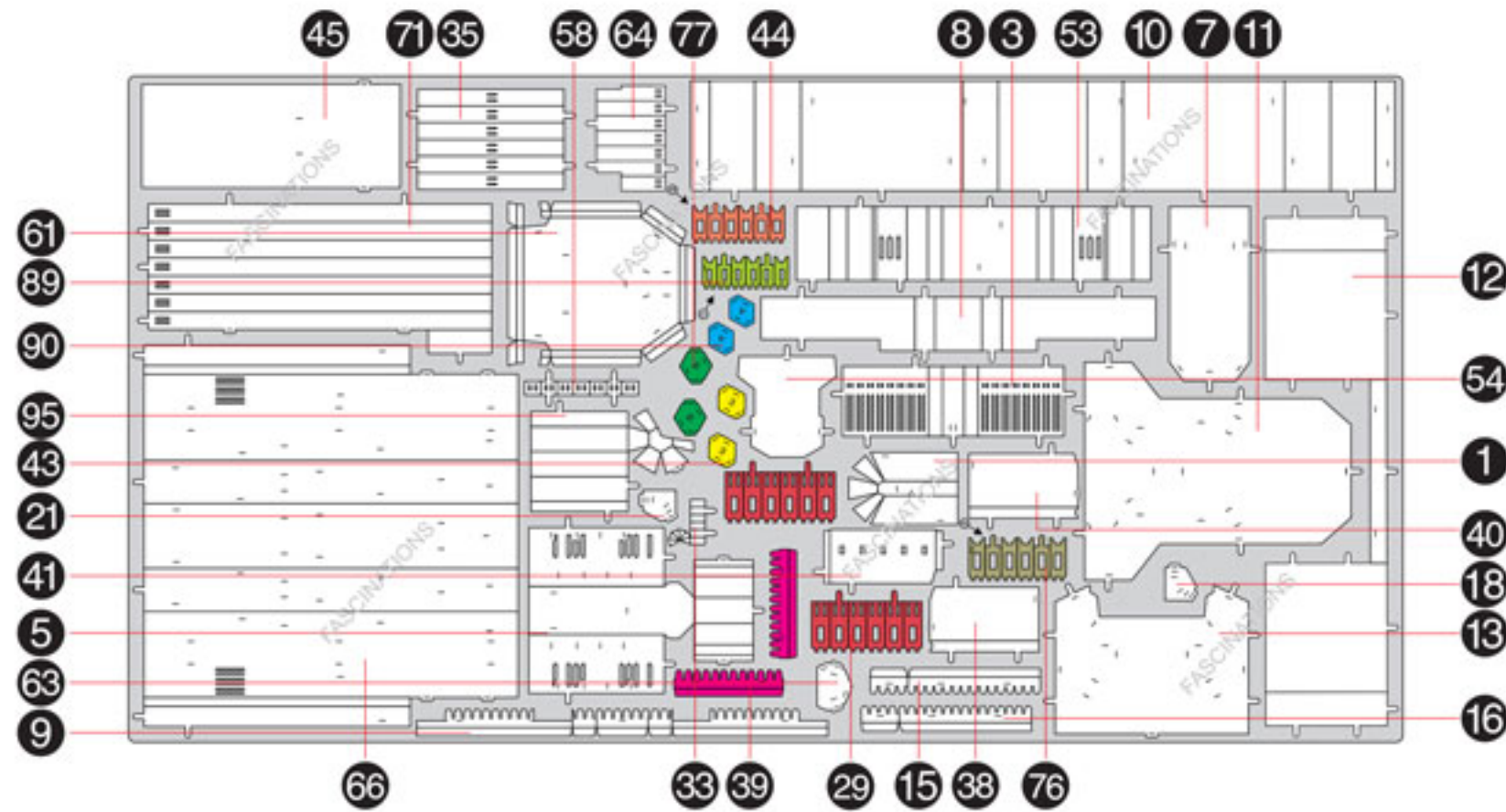

B

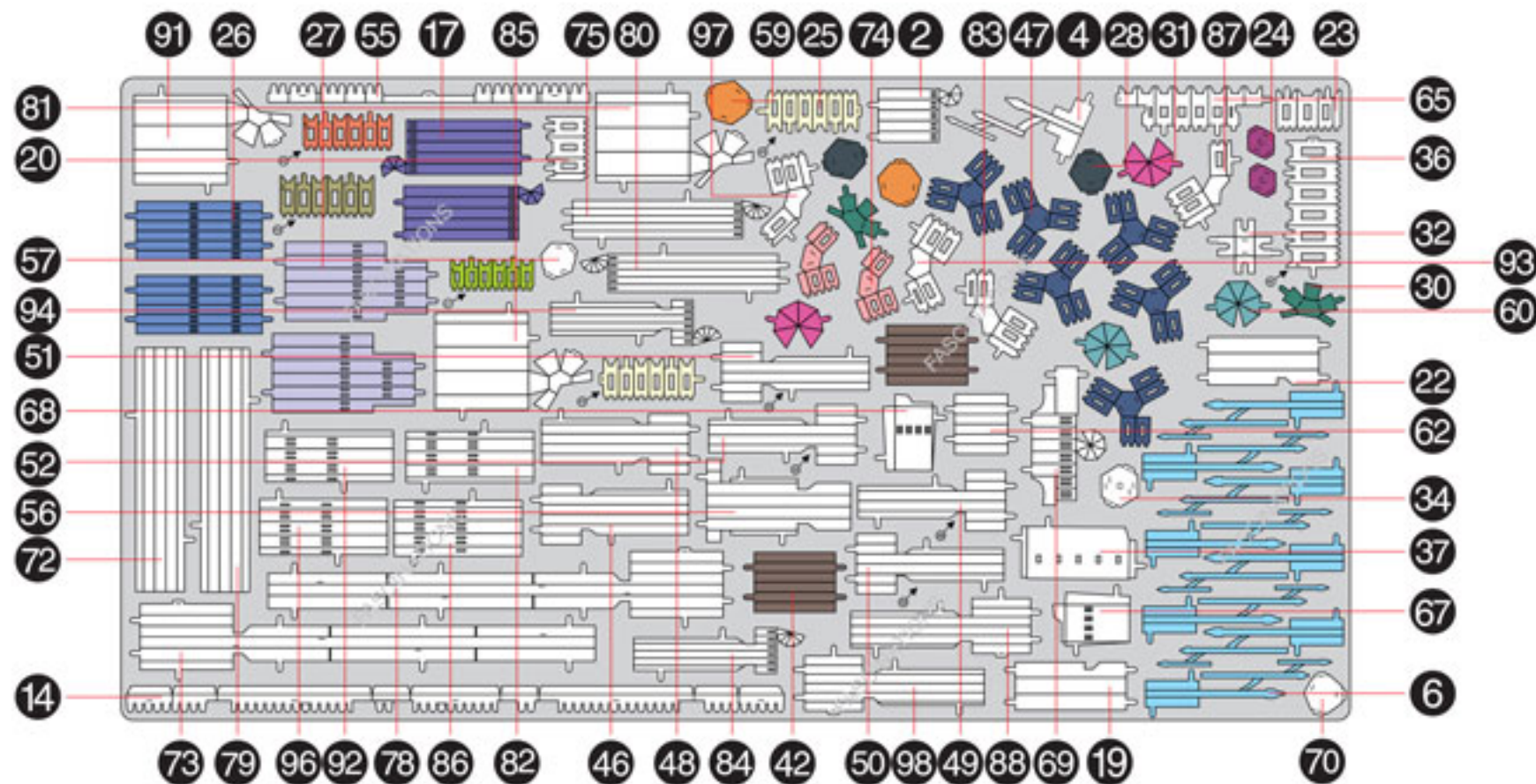

In order to avoid possible injury from sharp edges, please carefully discard the metal sheets after parts have been removed.

ICX 127

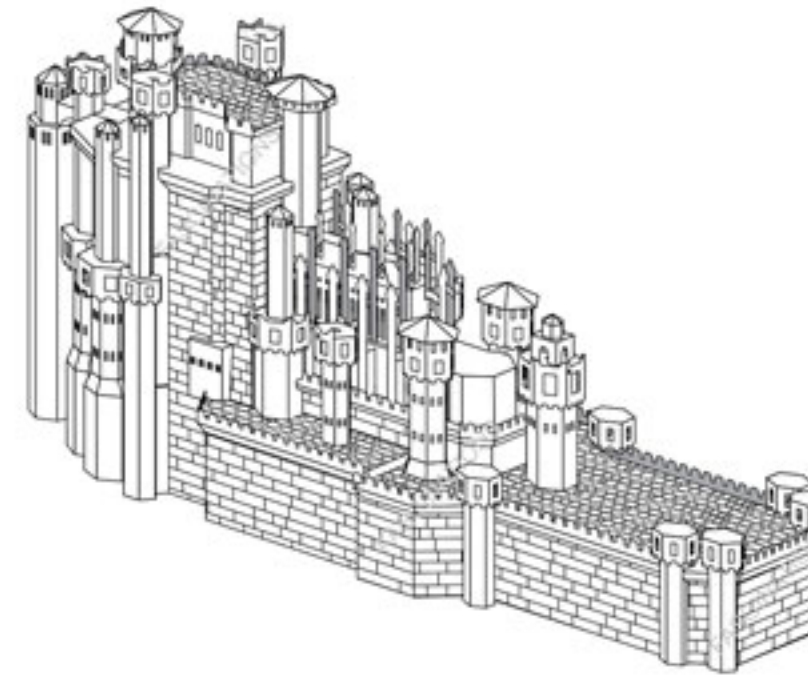

RED KEEP

TO CREATE THE BEST CONNECTIONS

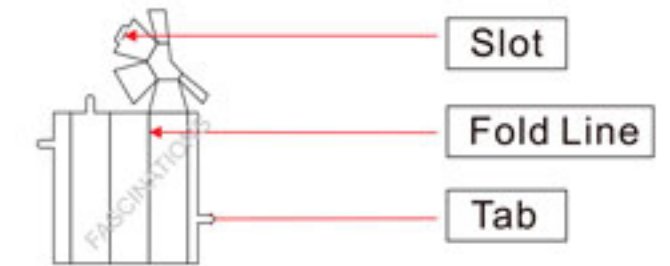

Legends:

- E** Engraved/Color side
- NE** Non-engraved/Silver side
- Attention point
- Insert tab and bend 90 degrees
- Insert tab and twist 90 degrees

Recommended tools:

-Wire cutters: helpful for taking parts from the metal sheets.



-Tweezers or needle nose pliers: helpful for folding parts, bending and twisting tabs.



Assembly tip:

If needed, slightly twist tabs to hold parts together then untwist and bend them down for a nice finish

ASSEMBLY STEPS

Step 1

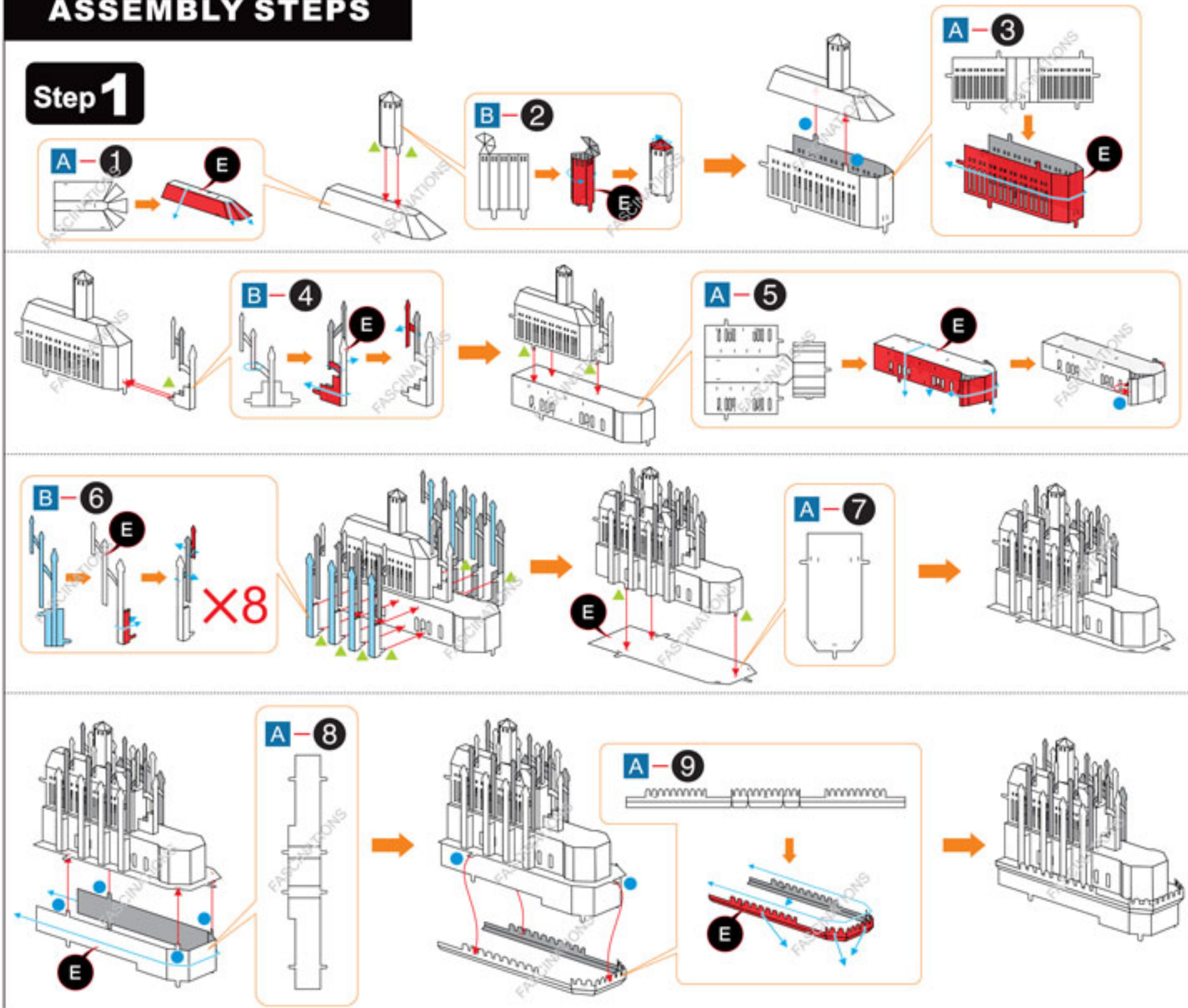

Step 2

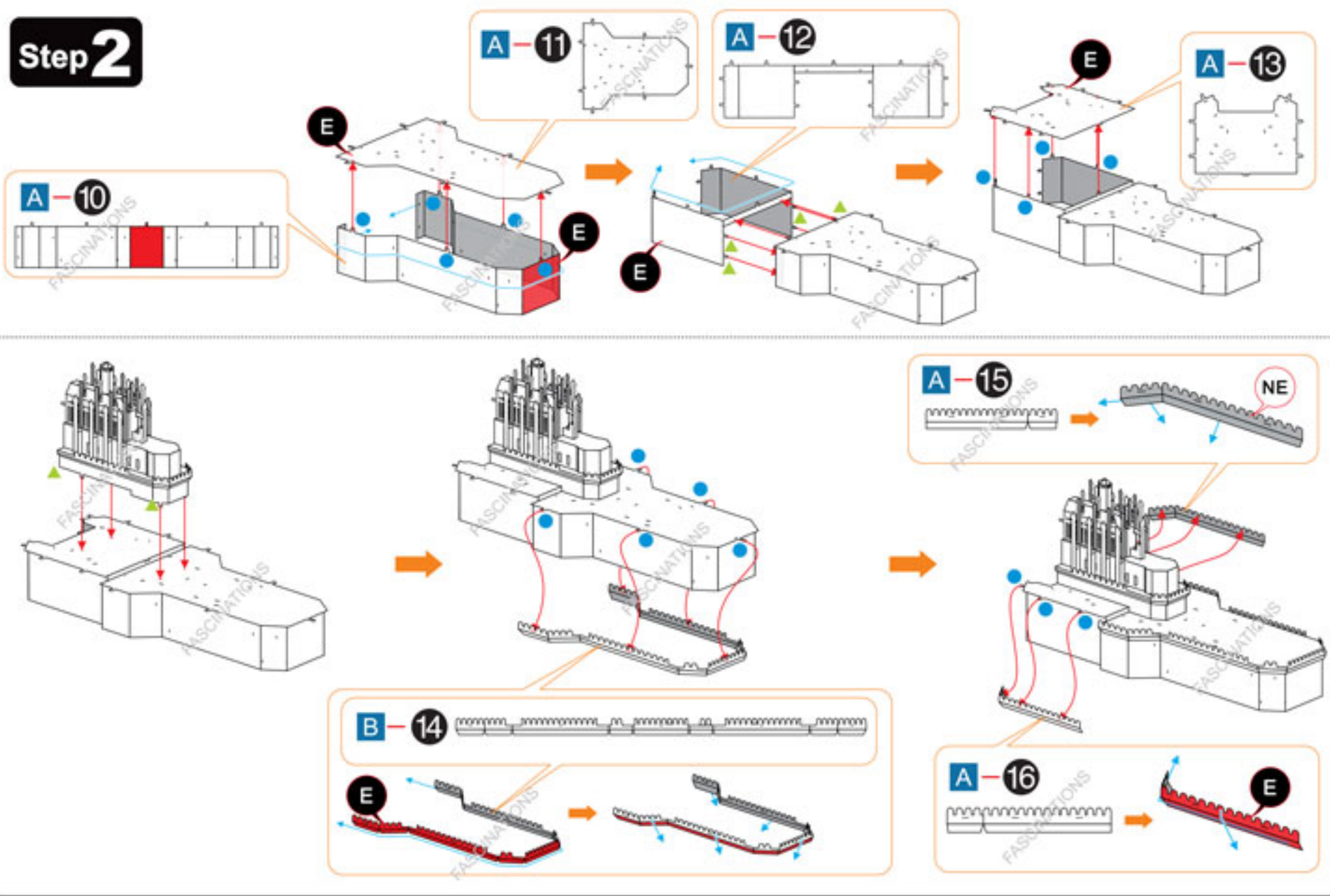

Step 3

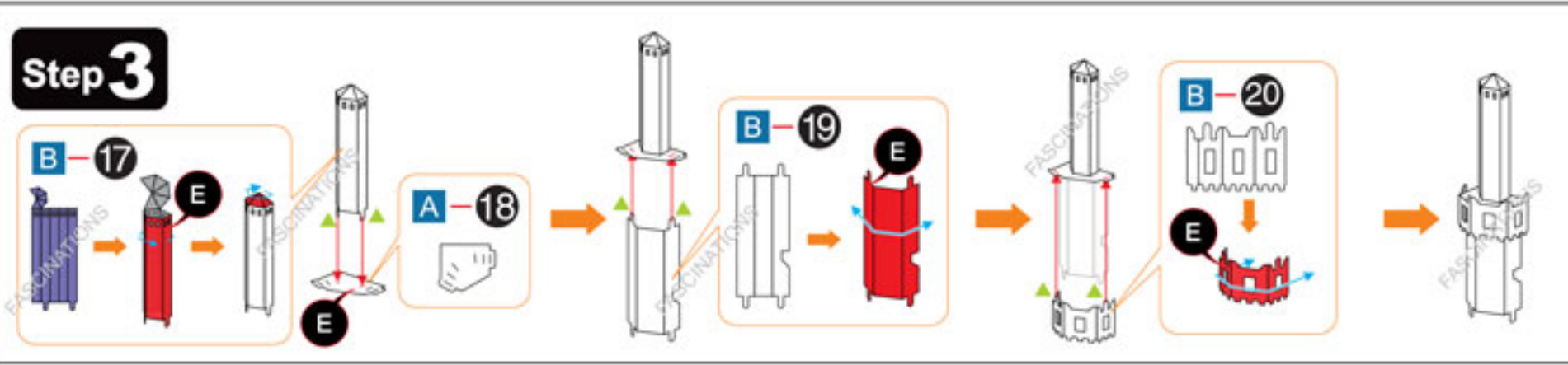

Step 4

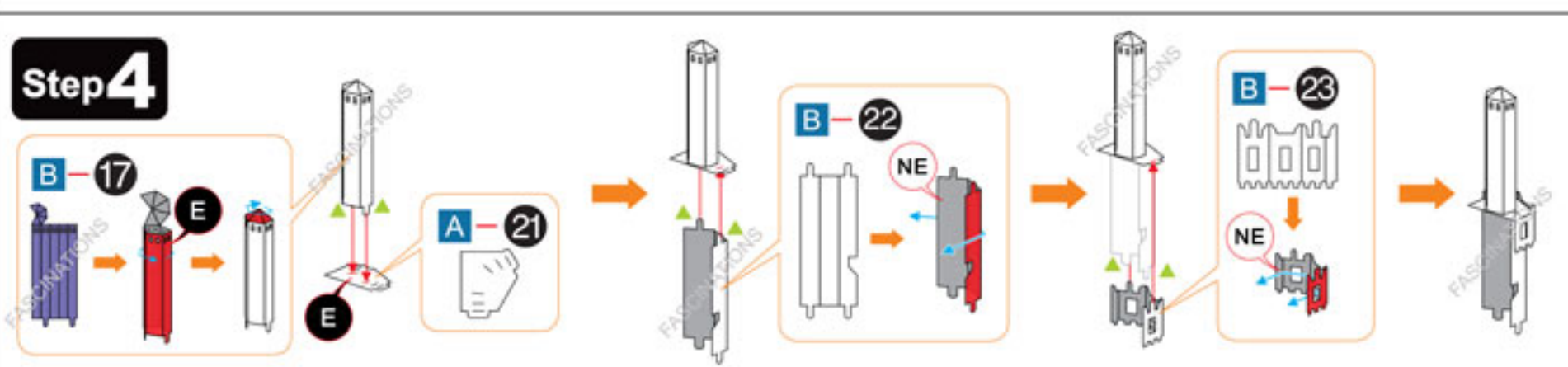

Step 5

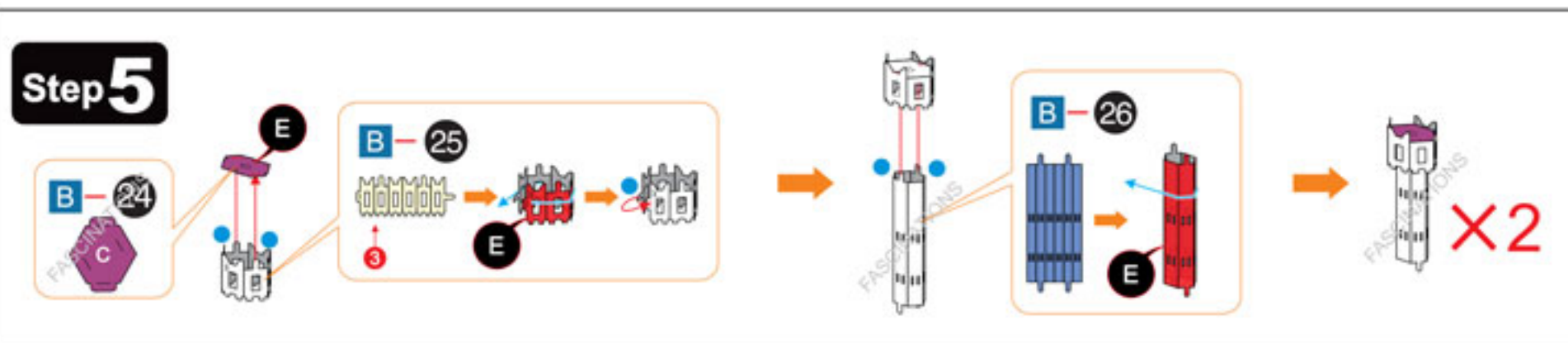

Step 6

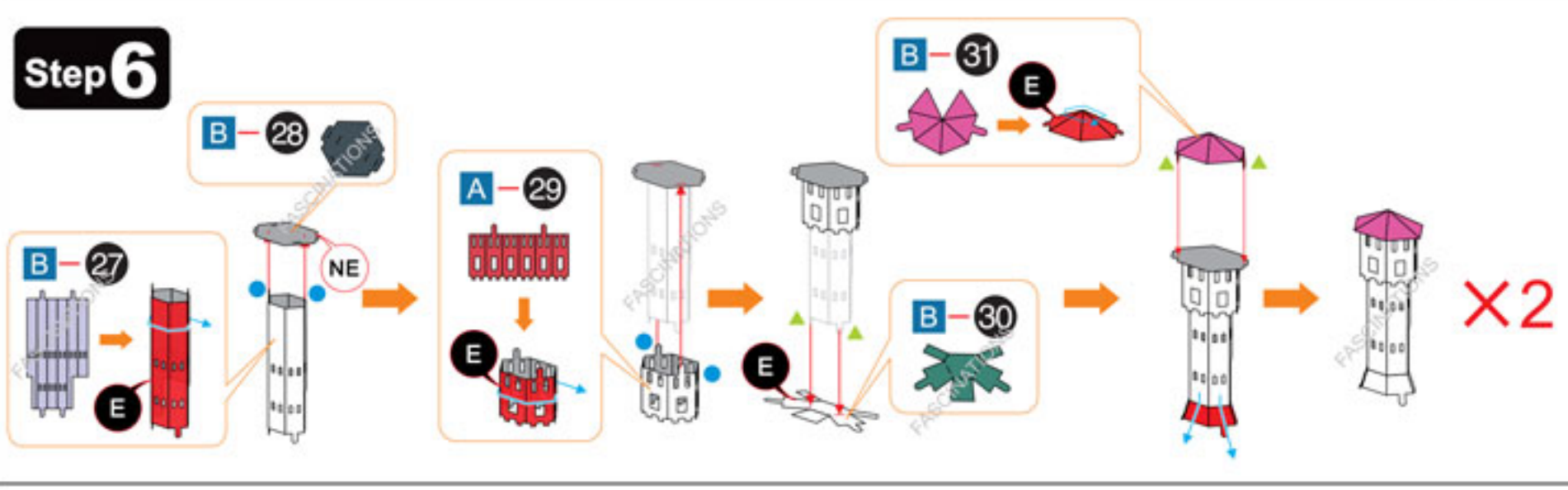

Step 7

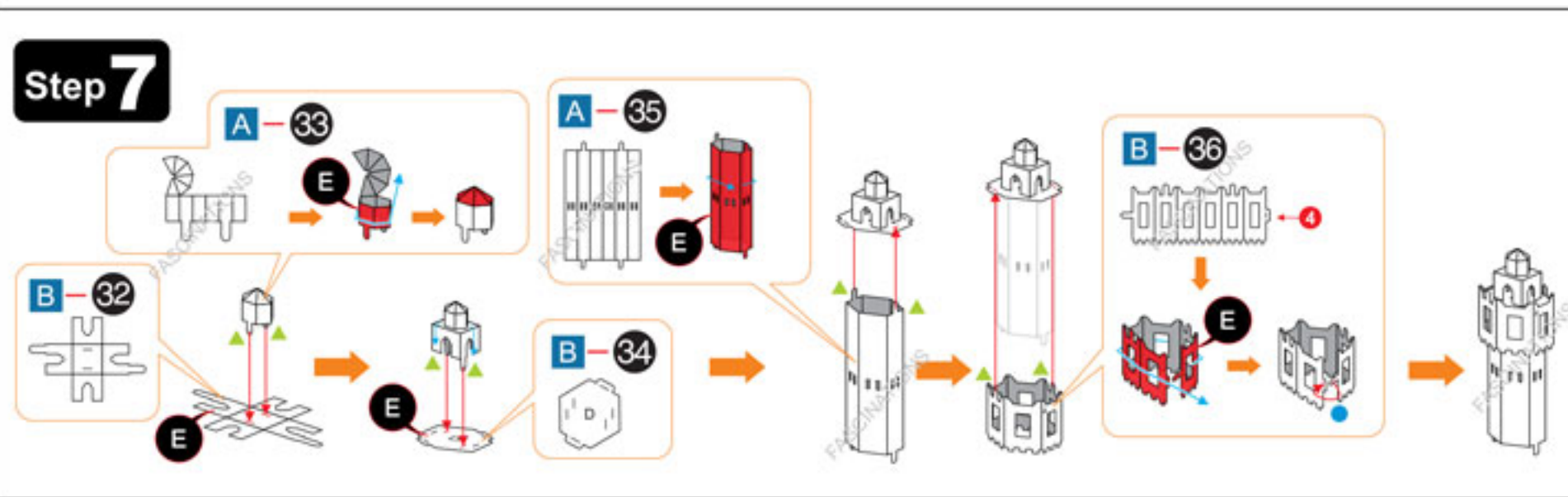

Step 8

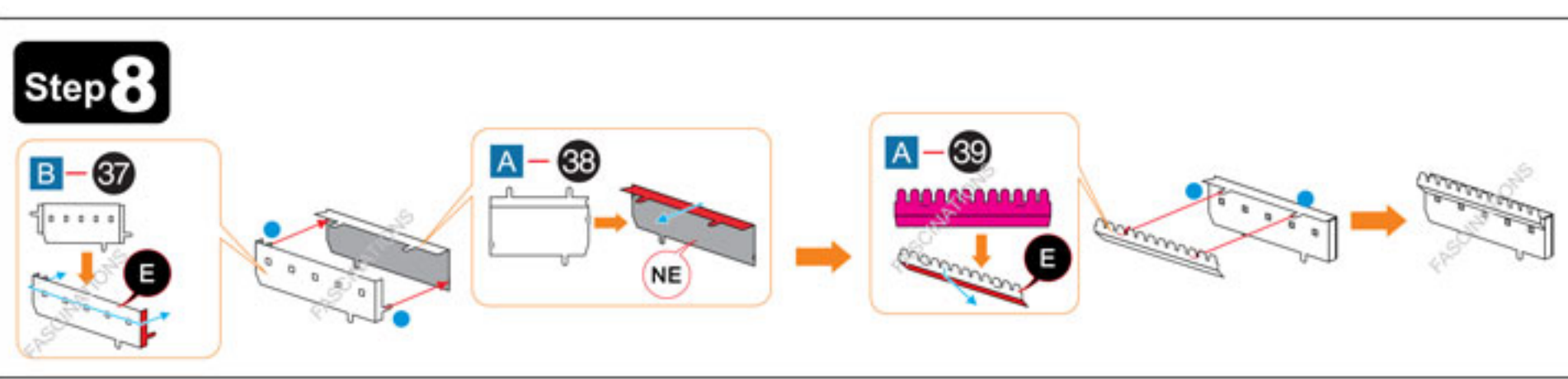

Step 9

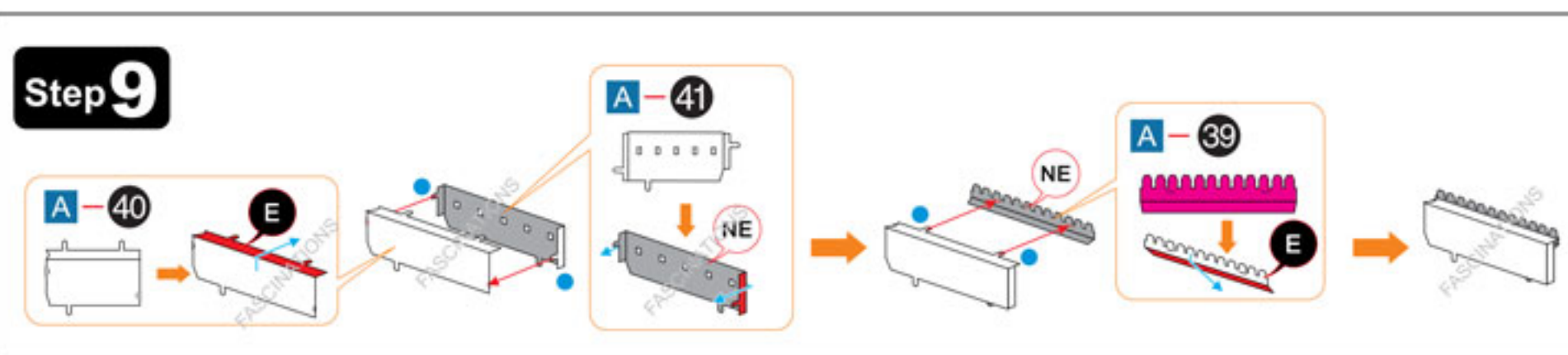

Step 10

