

# Owner's Manual

MMS50HA

Now with a Honda GC160!



POWERED by  
**HONDA**™



## WARNING

USE EXTREME CAUTION WHILE USING THIS EQUIPMENT. INJURY CAN OCCUR. READ CAREFULLY AND UNDERSTAND ALL ASSEMBLY AND SAFE OPERATION INSTRUCTIONS BEFORE OPERATING. FAILURE TO FOLLOW THE SAFETY RULES AND OTHER BASIC SAFETY PRECAUTIONS MAY RESULT IN SERIOUS PERSONAL INJURY.





### Table of Contents

- 1 INTRODUCTION ..... 5
  - 1.1 ...Application .....5
  - 1.2 ...Benefits.....5
  - 1.3 ...Navigating This Manual.....5
  - 1.4 ...Warnings and Safety Precautions .....5
  - 1.5 ...Operation References/Terminology .....7
  - 1.6 ...Owner Assistance.....8
  - 1.7 ...Model Identification.....8
  - 1.8 ...Further Assistance .....8
- 2 SAFETY ..... 9
  - 2.1 ...General Safety Rules.....9
  - 2.2 ...PRODUCT-SPECIFIC SAFETY RULES .....10
  - 2.3 ...ENGINE SAFETY PRECAUTIONS .....11
  - 2.4 ...Safety Decals.....14
  - 2.5 ...Training .....15
  - 2.6 ...Preparation.....15
  - 2.7 ...Operation .....15
  - 2.8 ...Maintenance and Storage .....16
- 3 PARTS BREAKDOWN ..... 17
  - 3.1 ...Frame Parts Breakdown.....17
  - 3.2 ...Transmission Parts Breakdown.....19
  - 3.3 ...Tines Parts Breakdown.....20
  - 3.4 ...General Information.....21
- 4 ASSEMBLY ..... 21
  - 4.1 ...Final Set-up .....25
- 5 OPERATING CONTROLS ..... 26
  - 5.1 ...Speed .....26
  - 5.2 ...Depth of Tilling .....26
  - 5.3 ...Throttle Control Lever.....26
  - 5.4 ...Engage Lever .....26
- 6 OPERATION ..... 26
  - 6.1 ...Before Operating .....26



6.2 ...Starting the Engine.....27

6.3 ...Pre-Start.....27

6.4 ...Filling Fuel Tank.....28

6.5 ...Checking and adding Oil.....28

6.6 ...Cold Starting Procedure.....29

6.7 ...Stopping Engine.....29

6.8 ...Operation.....29

6.9 ...Operation Tips.....31

6.10 .Tilling Pattern.....31

7     ADJUSTMENTS..... 31

7.1 ...Clutch Adjustment.....31

7.2 ...Wheel Height Adjustment.....32

7.3 ...Tine Adjustment.....32

8     Maintenance..... 33

8.1 ...Periodic Check.....33

8.2 ...Engine Oil.....33

8.3 ...Dual Filter Element Air Cleaner.....33

8.4 ...Cleaning the Cooling System.....34

8.5 ...Belt Replacement.....34

8.6 ...Cleaning.....34

9     LUBRICATION..... 35

9.1 ...Wheels.....35

9.2 ...Clutch Lever Pivots.....35

9.3 ...Transmission.....35

9.4 ...Idler Arms Pivot.....35

10    STORAGE..... 36

10.1 .Engine.....36

10.2 .Tiller.....36

11    TRANSPORTING..... 36

12    WARRANTY..... 37

12.1 .Warranty/Product Registration.....37

** WARNING****READ ENTIRE MANUAL BEFORE ATTEMPTING TO OPERATE MACHINE**

If incorrectly used, this machine can cause severe injury. Those who use and maintain this machine should be trained in its proper use, warned of its dangers, and should read the entire manual before attempting to set up, operate, adjust, or service this machine.

Read and keep this manual for future reference. This manual contains important information on **SAFETY, ASSEMBLY, OPERATION, AND MAINTENANCE**. The owner must be certain that all the product information is included with the unit. This information includes the **MANUAL**, the **REPLACEMENT PARTS** and the **WARRANTIES**. This information must be included to make sure state laws and other laws are followed. This manual should remain with the product even if it is resold.

** WARNING****THE ENGINE EXHAUST FROM THIS PRODUCT CONTAINS CHEMICALS KNOWN TO THE STATE OF CALIFORNIA TO CAUSE CANCER, BIRTH DEFECTS OR OTHER REPRODUCTIVE HARMS.**

**IMPORTANT:** This unit is equipped with an internal combustion engine and should not be used on or near any unimproved forest-covered, brush covered, or grass-covered land unless the engine's exhaust system is equipped with a spark arrester meeting applicable local laws (if any). If a spark arrester is used, it should be maintained in effective working order by the operator.

In the state of California, a spark arrester is required by law (section 4442 of the California public resources code). Other states may have similar laws. Federal laws apply on federal lands. See your authorized service center for a spark arrester.

## 1 INTRODUCTION

Maxim tillers feature rugged all-steel construction, heavy-duty welded tines and a ruggedly built transmission. It's this simple, yet sturdy design that makes Maxim tillers low maintenance and easy to use.

**Please read this entire manual before assembly and use. The manufacturer reserves the right to change, alter or improve the product and this document at any time without prior notice.**

### 1.1 Application

Our consumer tiller line is perfect for homeowners. We offer a wide array of easy to use tillers to provide you with the power and tine speed you need. Sturdiness, simplicity and ease of maintenance guaranteed, you only have to choose the model.

### 1.2 Benefits

- Transmission case components have double welded flanged tine shaft bearing supports for increased durability.
- Rugged all-steel construction
- Simplicity of design for ease of use and maintenance
- Adjustable tilling width
- Drag bar
- Heavy-duty tines

### 1.3 Navigating This Manual

1. Use this manual to help familiarize yourself with safety, assembly, operation, adjustments, troubleshooting, maintenance, specifications and warranty information. It is very important that you read this manual and follow the instructions to ensure safe operation of the attachment.
2. Please visit [www.maximmfg.com](http://www.maximmfg.com) for updated information.

### 1.4 Warnings and Safety Precautions

The safety of our customers and other's well-being is very important to us. Using this equipment is an important responsibility. Accurate assembly and safe and effective use of the machine is the owner's responsibility.

- Read and follow all safety instructions
- Carefully follow all assembly instructions
- Maintain the machine according to directions and schedule included in this manual.
- Ensure that anyone who uses the machine is familiar with all controls and safety precautions.

**SPECIAL MESSAGES**

Your manual contains special message to bring attention to potential safety concerns, machine damage as well as helpful operating and servicing information. Please read all the information carefully to avoid injury and machine damage. This information alerts you to potential hazards that could hurt you or others.

**NOTE: General information is given throughout the manual that may help the operator in the operation or service of the machine.**

You will find important safety information in a variety of forms, including:

1. Safety labels – on the tillers
2. Safety messages – preceded by a safety alert symbol  and one of the three signal words: **DANGER, WARNING, OR CAUTION.**

These signal words mean:

**DANGER:** You will be killed or seriously injured if you don't follow instructions



**WARNING:** You can be killed or seriously injured if you don't follow instructions.

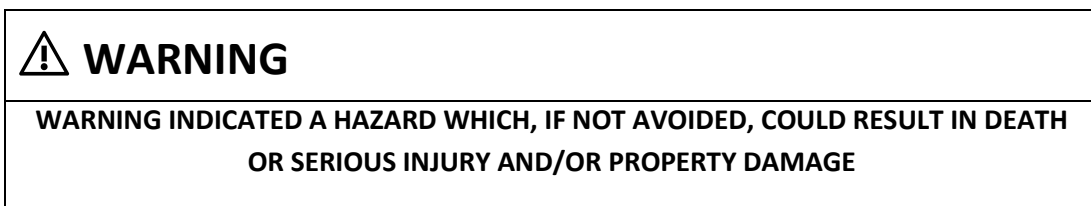

**CAUTION:** You can be injured if you don't follow instructions.

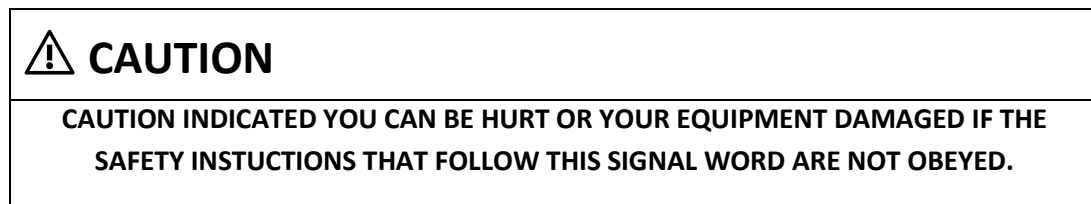

**⚠ WARNING****CALIFORNIA PROPOSITION 65 WARNING**

ENGINE EXHAUST FROM THIS PRODUCT CONTAINS CHEMICALS KNOWN TO THE STATE OF CALIFORNIA TO CAUSE CANCER, BIRTH DEFECTS, OR OTHER REPRODUCTIVE HARM.

**⚠ WARNING**

**YOU MUST READ, UNDERSTAND AND COMPLY WITH ALL SAFETY AND OPERATING INSTRUCTIONS IN THIS MANUAL BEFORE ATTEMPTING TO SETUP AND OPERATE YOUR MACHINE.**

**FAILURE TO COMPLY WITH ALL SAFETY AND OPERATING INSTRUCTIONS CAN RESULT IN LOSS OF MACHINE CONTROL, SERIOUS PERSONAL INJURY TO YOU AND/OR BYSTANDERS, AND RISK OF EQUIPMENT AND PROPERTY DAMAGE. THE TRIANGLE IN THE TEXT SIGNIFIES IMPORATNT CAUTIONS OR WARNINGS WHICH MUST BE FOLLOWED**

**⚠ This symbol points out important safety instructions which if not followed could endanger your personal safety. Read and follow all instructions in this manual before attempting to operate this equipment.**

**BEFORE OPERATING ENGINE:**

**Please read this section carefully.** Read entire operating and maintenance instructions for this product. Failure to follow instructions could result in serious injury or death. Operate the machine according to the safety instructions outlined here and inserted throughout the text. Anyone who uses this machine must read the instructions and be familiar with the controls.

**Intended Use / Foreseeable Misuse**

**IMPORTANT:** This is a motorized rotary tiller that works the soil by means of rotating tines. It is pedestrian-controlled, but not self-propelled, with a gasoline-fueled internal combustion engine to power the tines. It shall not be used for any other purpose.

**1.5 Operation References/Terminology**

References throughout this manual referred to as “Right” or “Left” are determined standing behind tiller and facing the direction the unit will operate while in use.

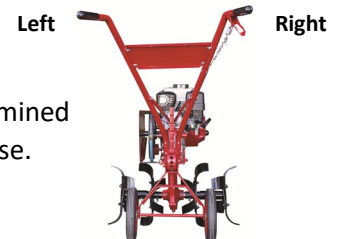

### 1.6 Owner Assistance

Please complete the Warranty/Product Registration at the time of purchase. You will need to complete the warranty/product registration form (pg. 38) with your new unit, or you may visit our website [www.maximmfg.com](http://www.maximmfg.com) and complete our online product registration form. We require this information, so we can keep you updated with any important information about your tiller and provide you with the best customer service possible.

The parts and components used on your Maxim tiller have been specifically engineered for Maxim tiller and should only be replaced with Maxim parts. Contact your local Maxim Dealer for OEM replacement parts or contact our customer service department for assistance in parts, locating your local servicing dealer and more. Your local dealer is equipped and trained to handle service and repair for your tiller.

### 1.7 Model Identification

Please fill in your model and serial number below for future reference. This will help assist in prompt service when ordering parts and service from your local Maxim Dealer.

Tiller Model No. \_\_\_\_\_ Tiller Serial No. \_\_\_\_\_

Engine Model No. \_\_\_\_\_ Engine Serial No. \_\_\_\_\_

Refer to the image below for location of your serial number plate:



### 1.8 Further Assistance

Your dealer and all of us at Maxim want you to be pleased with your tiller. Should you require further assistance or have questions regarding your tiller, please contact your local dealer where you purchased your tiller. If you are unable to satisfy your needs by your local dealer, please contact us at:

Maxim  
20195 South Diamond Lake Road, STE 100  
Rogers, MN 55374  
800-621-2789  
[www.maximmfg.com](http://www.maximmfg.com)



## 2 SAFETY

### 2.1 General Safety Rules

- Read, understand and follow all instructions on the machine and in the manual(s). Be thoroughly familiar with the controls and proper use of the machine before starting.
- Use this equipment for its intended purpose only.
- Familiarize yourself with all of the safety and operating decals on this equipment and on any of its attachments or accessories.
- Do not put hands or feet near or under rotating parts.
- Only allow responsible individuals who are familiar with the instructions to operate the machine. Do not allow children to operate this machine. Do not allow adults to operate the machine without proper instruction.
- Thoroughly inspect the area where the machine is to be used and remove all foreign objects. Your equipment can propel small objects at high-speed causing personal injury or property damage. Stay away from breakable objects, such as house windows, automobiles, greenhouse, etc.
- Wear appropriate clothing such as sturdy, rough-soled shoes (steel toe recommended) and close-fitting pants and shirt. Loose fitting clothes or jewelry can be caught in moving parts. Never wear shorts. Never wear sandals, sneakers or open shoes, and never operate the machine with bare feet.
- Do not wear loose clothing or jewelry. They can get caught in moving parts. Always keep hands, feet, hair, and loose clothing away from any moving parts on engine and machine.
- Always wear safety goggles or safety glasses with side shields when operating the machine to protect your eyes from foreign objects which can be thrown from the unit.
- Always wear a protective hearing device.
- Always wear work gloves and sturdy rugged soled footwear. Wear footwear that will improve footing on slippery surfaces. Leather work shoes or short boots work well for most people. These will protect the operator's ankles and shins from small sticks, splinters, and other debris.
- It is advisable to wear protective headgear to prevent the possibility of being struck by small flying particles, or being struck by low hanging branches, twigs or other objects which may be unnoticed by the operator.
- Do not operate the machine without proper guards or other safety protective devices in place.
- See manufacturer's instructions for proper operation and installation of accessories. Only use accessories approved by the manufacturer.
- Operate only in daylight.
- Do not operate product when fatigued or under the influence of alcohol, drugs or other medication which can cause drowsiness or affect your ability to operate machine safely.

- Never operate machine in wet grass. Always be sure of your footing; keep a firm hold on the handle and walk; never run.
- Watch for traffic when operating tiller near, or when crossing roads.
- If the equipment should start to vibrate abnormally, stop the engine (motor), flip the ON/OFF switch to the **OFF** position located on engine.
- Regularly inspect the machine. Make sure parts are not bent, damaged or loose.
- Temperature of muffler and nearby areas may exceed 150° F (65° C). Allow muffler and engine areas to cool before touching.
- Never pick up or carry the machine while the engine is running.
- Prolonged exposure to noise and vibration from gasoline engine-powered equipment should be avoided. Take intermittent breaks and/or wear ear protection from engine noise as well as heavy work gloves to reduce vibration in hands.
- Keep all screws, nuts and bolts tight.
- Do not transport the machine from one place to another with the engine running.
- Always turn off fuel supply valve on engine before transport.
- When moving the packaged machine, always do so with a partner.
- Check local regulations for age restrictions on use of this machine.

## 2.2 PRODUCT-SPECIFIC SAFETY RULES

- Do not till above underground utilities, including water lines, gas lines, electric cables or pipe. Contact appropriate utility representatives to determine if/where electrical cables, gas lines, water lines, etc. are buried **BEFORE** operation.
- Do not operate the machine on terrain/soil with large rocks and foreign objects which can damage the equipment.
- After striking a foreign object, stop the engine. Flip the ON/OFF switch to the **OFF** position located on engine. Inspect the machine for damage. If damaged, repair before starting and operating the machine.
- The tines of the tiller should not rotate when the engine is idling. If they do, contact your local dealer or Maxim technical service for instruction.
- If an object becomes lodged in the tines, flip the ON/OFF switch to the **OFF** position located on engine, then allow the machine to cool before attempting to remove the foreign object.
- The idler and belt will transfer maximum power after about two hours of normal operation. During this break-in period clutch slippage may occur. The clutch should be kept free of oil or other moisture for efficient operation.

## 2.3 ENGINE SAFETY PRECAUTIONS

### Warning Carbon Monoxide Poisoning

Engines give off carbon monoxide, an odorless, colorless, poisonous gas. Carbon monoxide may be present even if you do not smell or see any engine exhaust. Breathing carbon monoxide can cause nausea, fainting or death, in addition to drowsiness, dizziness and confusion. If you experience any of these symptoms, seek fresh air and medical attention immediately.

### **WARNING**

**ENGINES GIVE OFF CARBON MONOXIDE, AN ODORLESS, COLORLESS, POISONOUS GAS. CARBON MONOXIDE MAY BE PRESENT EVEN IF YOU DO NOT SMELL OR SEE ANY ENGINE EXHAUST. BREATHING CARBON MONOXIDE CAN CAUSE NAUSEA, FAINTING OR DEATH, IN ADDITION TO DROWSINESS, DIZZINESS AND CONFUSION.**

**IF YOU EXPERIENCE ANY OF THESE SYMPTOMS, SEEK FRESH AIR AND MEDICAL ATTENTION IMMEDIATELY.**

### **CAUTION**

**HOT GASES ARE A NORMAL BY-PRODUCT OF A FUNCTIONING INTERNAL COMBUSTION ENGINE. FOLLOW ALL SAFETY INSTRUCTIONS TO PREVENT BURNS AND FIRES.**

**DO NOT ALTER/MODIFY ENGINE:**

**NEVER ALTER OR MODIFY THE ENGINE FROM THE FACTORY. SERIOUS INJURY OR DEATH MAY OCCUR IF ENGINE IS MODIFIED OR ALTERED.**

**WHEN WORKING ON OR REPLACING PARTS FOR THE ENGINE OR PRODUCT, YOU MUST ALWAYS FLIP THE ON/OFF SWITCH TO THE OFF POSITION.**

### **PREVENTING CARBON MONOXIDE POSIONING**

- Always start and run engine outdoors. Do not start or run engine in an enclosed area, even if doors or windows are open.
- Never try to ventilate engine exhaust indoors. Carbon monoxide can reach dangerous levels very quickly.
- Never run engine outdoors where exhaust fumes may be pulled into a building.
- Never run engine outdoors in a poorly ventilated area where the exhaust fumes may be trapped and not easily taken away. (Examples include: in a large hole or areas where hills surround your working area.)
- Never run engine in an enclosed or partially enclosed area. (Examples include: buildings that are enclosed on one or more sides, under tents, car ports or basements.)
- Always run the engine with the exhaust pointed in the direction away from the operator.

- Never point the exhaust towards anyone. People should always be a minimum of ten feet away from the operation of the engine and its attachments.
- Do not change the engine governor settings or over-speed the engine.

### **GASOLINE FIRES AND HANDLING FUEL SAFELY**

#### **⚠ Warning gasoline is highly flammable and explosive**

**You can be burned or seriously injured when handling fuel. Use extreme care when handling gasoline or other fuels. They are flammable, and vapors are explosive.**

- When storing extra fuel be sure that it is in an appropriate container and away from any fire hazards.
- Prevent fire and explosion caused by static electric discharge. Use only nonmetal, portable fuel containers approved by the Underwriter's Laboratory (U.L.) or the American Society for Testing & Materials (ASTM).
- Always fill fuel tank outside in a well-ventilated area. Never fill fuel tank with fuel indoors. (Examples include: basement, garage, barn, shed, house, porch, etc.) Never fill tank near appliances with pilot lights, heaters, or other ignition sources. If the fuel has to be drained, this should be done outdoors. The drained fuel should be stored in a container specifically designed for fuel storage or it should be disposed of carefully.
- Never remove the fuel cap or add fuel with the engine running. Stop engine and allow to cool before filling.
- Do not smoke while using engine or around fuel.
- Never drain fuel from engine in an enclosed area.
- Always wipe up excess (spilled) fuel from engine before starting. Clean up spilled fuel immediately. If fuel is spilled, do not start the engine but move product and fuel container from area. Clean up spilled fuel and allow to evaporate and dry after wiping and before starting.
- Allow fuel fumes/vapors to escape from the air before starting the engine.
- Test the fuel cap for proper installation before starting and using engine.
- Always run the engine with fuel cap properly installed on the engine.
- Never smoke while refilling engine fuel tank.
- Do not store engine with fuel in fuel tank indoors. Fuel and fuel vapors are highly explosive.
- Never pour fuel from engine fuel tank.
- Never siphon fuel by mouth to drain fuel tank.
- Always have an adult fill the fuel tank and never allow children to fill the engine.
- Never allow anyone under the influence of drugs or alcohol to fill the engine.

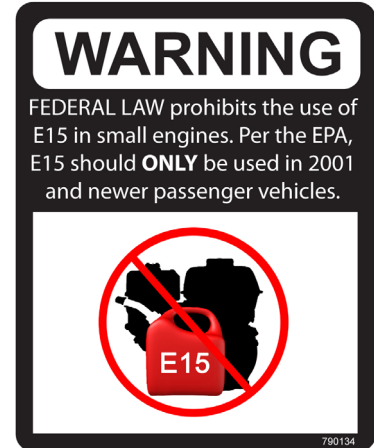

- When storing gasoline or equipment with fuel in the tank, store away from furnaces, stoves, water heaters or other appliances that have a pilot light or other ignition source because they can ignite gasoline vapors.

### **BURNS AND FIRES**

The muffler, muffler guard and other parts of the engine become extremely hot during the operation of the engine. These parts remain extremely hot after the engine has stopped.

- Never remove the muffler guard from the engine.
- Never touch the muffler guard because it is extremely hot and will cause severe burns.
- Never touch parts of the engine that become hot after operation.
- Always keep materials and debris away from the muffler guard and other hot parts of the engine to avoid fires.

### **CHILDREN AND BYSTANDERS**

Tragic accidents can occur if the operator is not alert to the presence of children and/or bystanders. Never assume that others will remain where you last saw them.

- Keep the area of operation clear of all persons, especially small children and pets. Keep children under the watchful care of a responsible adult.
- Be alert and turn machine off if children enter the area.
- Before and while moving backwards, look behind and down for small children.
- Never allow children to operate the machine.
- Use extra care when approaching blind corners, shrubs, trees, or other objects that may obscure vision.

### **SERVICE**

- Always stop the engine whenever you leave the equipment, before cleaning, repairing or inspecting the unit. Engine should be turned off and cool. Never make adjustments or repairs with the engine (motor) running. Flip the ON/OFF switch to the **OFF** position, located on engine, to prevent accidental starting.
- Always wear eye protection when you make adjustments or repairs.
- Keep all nuts and bolts tight and keep equipment in good condition.
- Never tamper with safety devices. Check their proper operation regularly.
- When servicing or repairing the machine, do not tip the machine over or up unless specifically instructed to do so in this manual. Service and repair procedures can be done with the machine in an upright position. Some procedures will be easier if the machine is lifted on a raised platform or working surface.
- To reduce fire hazard, keep machine free of grass, leaves or other debris build-up. Clean up oil or fuel spillage. Allow machine to cool before storing.

- Stop and inspect the equipment if you strike an object. Repair, if necessary, before restarting.
- Clean and replace safety and instruction decals as necessary.
- To guard against engine over-heating, always have engine air filter mounted and clean.
- Inspect machine before storage. When not in use, flip the ignition ON/OFF switch to the **OFF** position and store indoors in a dry place locked or otherwise inaccessible to children.
- Use only original equipment parts from the factory, including all nuts and bolts.

## 2.4 Safety Decals

This Tiller has been designed and manufactured to provide you the safety and reliability you would expect from an industry leader in outdoor power equipment manufacturing.

Reading this manual and the safety instructions it contains will provide you with the necessary basic knowledge to operate this equipment safely and effectively. We have placed safety decals on the tiller to remind you of some of this important information while you are operating the unit.

These important safety decals are illustrated below and are shown here to help familiarize you with the content of the safety messages you will see as you perform normal tilling operations. Please review these decals now, and if you have any questions regarding its meaning or how to comply with these instructions, reread the complete safety instruction text in this manual, or contact your local dealer.

Should a decal become unreadable because of being worn, faded or otherwise damaged during the use of your tiller; please use the part number information provide to order a replacement label. These decals are easily applied and will act as a constant visual reminder to you, and others who may use the equipment, to follow the safety instructions necessary for safe, effective operation of your tiller.

<p><b>Item # 366720</b></p> 	<p><b>Item # 336784</b></p> 	<p><b>Item # 336776</b></p> 	<p><b>Item # 336777</b></p> 
<p><b>Item # 799546</b></p>	<p><b>WARNING:</b> This product can expose you to chemicals including soots, tars, and mineral oils, which are known to the State of California to cause cancer, and carbon monoxide, which is known to the State of California to cause birth defects or other reproductive harm. For more information go to <a href="http://www.P65Warnings.ca.gov">www.P65Warnings.ca.gov</a>.</p>		<p><b>Item # ZS001</b></p> 
<p><b>Item # 336799</b></p> 	<p><b>Item # 87108</b></p> 		

## 2.5 Training

1. Read the Owner's Manual carefully. Be thoroughly familiar with the controls and the proper use of the equipment. Know how to stop the unit and disengage the tines quickly.
2. Never allow children to operate the equipment. Never allow adults to operate the equipment without proper instructions.
3. Keep the area of operation clear of all persons, particularly small children and pets.
4. Always stay alert. Watch what you are doing and use common sense. Do not operate unit when fatigued.
5. Understand the use of all tiller controls.

## 2.6 Preparation

1. Thoroughly inspect the area where the equipment is to be used and remove all foreign objects.
2. Disengage the idler before starting the engine (motor).
3. Always wear substantial footwear and long pants. Do not operate the equipment when barefoot or wearing open sandals.
4. Wear ear and eye protection. Eye protection must meet applicable CE requirements. To avoid hearing damage, we recommend hearing protection be worn whenever using the equipment.
5. Handle fuel with care; it is highly flammable.
6. Use an approved fuel container.
7. Never add fuel to a running engine or hot engine.
8. Fill fuel tank outdoors with extreme care. Never fill fuel tank indoors.
9. Replace gasoline cap securely and clean up spilled fuel before starting.
10. Never attempt to make any adjustments while the engine (motor) is running.

## 2.7 Operation

1. Do not put hands or feet near or under rotating parts.
2. Exercise extreme caution when operating on or crossing gravel drives, walks, or roads. Stay alert for hidden hazards or traffic. Do not carry passengers.
3. After striking a foreign object, stop the engine (motor) by turning the ON/OFF switch to **OFF**, located on engine, thoroughly inspect the tiller for any damage, and repair the damage before restarting and operating the tiller.
4. Exercise caution to avoid slipping or falling.
5. If the unit should start to vibrate abnormally or make unusual noise, stop the engine (motor) and check immediately for the cause. Vibration is generally a warning of trouble.
6. Stop the engine (motor) when leaving the operating position.
7. Take all possible precautions when leaving the machine unattended. Disengage the tines and stop the engine by turning the ON/OFF switch to **OFF**, located on engine.



8. Before cleaning, repairing, or inspecting, shut off the engine and make certain all moving parts have stopped. Disconnect the spark plug wire and keep the wire away from the plug to prevent accidental starting.
9. Do not run the engine indoors; exhaust fumes are dangerous.
10. Never operate the tiller without proper guards, plates, or other safety protective devices in place.
11. Keep children and pets away when operating.
12. Do not overload the machine capacity by attempting to till too deep or too fast.
13. Never operate the machine at high speeds on slippery surfaces. Look behind and use care when backing up.
14. Never allow bystanders near the unit.
15. Use only attachments and accessories approved by the manufacturer of the tiller.
16. Never operate the tiller without good visibility or light.
17. Be careful when tilling in hard ground. The tines may catch in the ground and propel the tiller forward. If this occurs, let go of the handlebars and do not restrain the machine.

## **2.8 Maintenance and Storage**

1. Keep machine, attachments, and accessories in safe working conditions.
2. Check assembly pins, engine mounting bolts, and other bolts at frequent intervals for proper tightness to be sure the equipment is in safe working condition.
3. Never store the machine with fuel in the fuel tank inside a building where ignition sources are present, such as hot water and space heaters, clothes dryers, etc. allow the engine to cool before storing in any enclosure.
4. Always refer to the storage instructions (Section 10) for important details if the tiller is to be stored for an extended period.



### 3 PARTS BREAKDOWN

#### 3.1 Frame Parts Breakdown

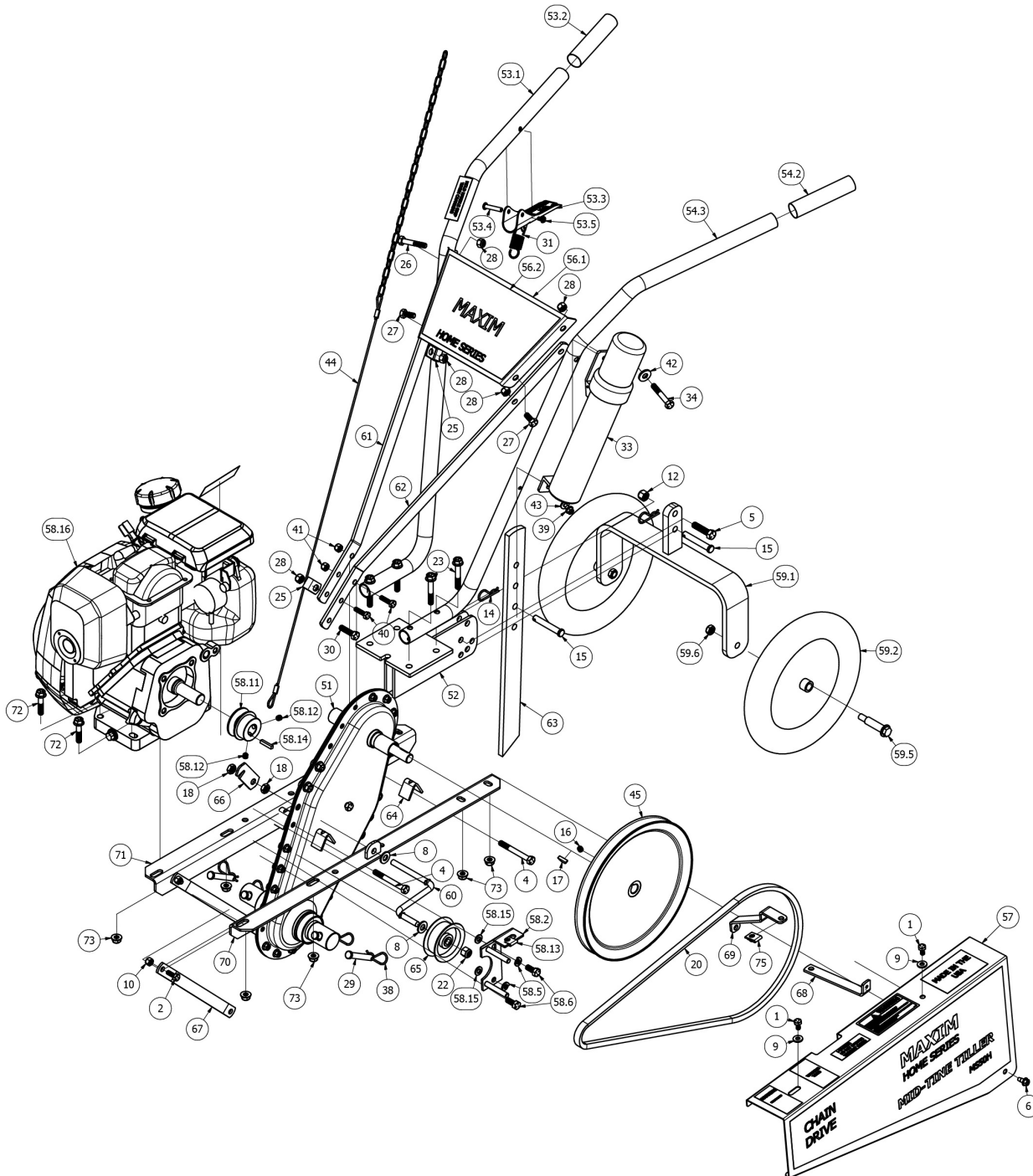

Belt Guard Decal  
Part # 88149



Cross Brace Decal  
Part # 88148



Made In USA Decal  
Part # 797158



# MS50H

REF #	QTY	PART #	DESCRIPTION
1	2	80027	BOLT,HHCS,1/4-20 X 1/2,GR5,ZINC
2	3	80029	BOLT, HEX, 1/4-20 X 3/4, GR5, ZINC
4	2	80045	BOLT, HHCS, 5/16-18 X 2 3/4, GR5, ZINC
5	1	80053	3/8-16 X 1-1/2 HEX SCREW GR 5-ZINC
6	1	80193	1/4-20 X 1/2 THRD CUT HEX - ZINC
8	2	80206	WASHER, SAE, 3/8, ZINC
9	2	80212	1/4 USS FLAT WASHER - ZINC
10	3	85128	1/4" NYLON LOCK NUT
11	2	86101	5/16 NYLON LOCK NUT
12	1	86383	NUT, NYLOCK, 3/8-16, GR5, ZINC
14	2	87264	HAIRPIN, RU, 3/8-7/16, 1-7/8, ZINC
15	2	87265	PIN, CLEVIS, 3/8, 2-1/4, ZINC
16	1	87268	5/16-18 X 5/16 SETSCREW ZN
17	1	87269	3/16 X 3/4 WOODRUFF KEYK9N
18	2	87330	NUT, JAM, 3/8-24, ZINC
20	1	87333	BELT, 4L500 (MS)
22	1	87422	3/8-24 NYLOCK NUT
23	4	87439	BOLT, FHH, 5/16-18 X 2, GR5, ZINC
25	2	87374	P-CLIP, 3/8 X 9/16, GAL
26	1	80039	5/16-18 X 1-3/4 HEX SCREW GR 5-
27	2	80037	5/16-18 X 3/4 HEX SCREW GR 5-ZINC
28	5	86101	5/16 NYLON LOCK NUT
29	4	87265	PIN, CLEVIS, 3/8, 2-1/4, ZINC
30	1	86115	5/16-18 X 1-1/4 HEX SCREW GR 5-ZINC
31	1	87416	SPRING, EXTENSION
33	1	87438	HOLDER, MANUAL, SMALL
34	1	80042	5/16-18 X 2 HEX SCREW GR 5 - ZINC
38	4	87264	HAIRPIN, RU, 3/8-7/16, 1-7/8, ZINC
39	1	80193	1/4-20 X 1/2 THRD CUT HEX - ZINC
40	2	86034	1/4 X 1 HEX SCREW GR 5 - ZINC
41	2	85128	1/4" NYLON LOCK NUT
42	1	80214	WASHER, 5/16, USS, ZINC
43	1	80212	1/4 USS FLAT WASHER - ZINC
44	1	87568	ASSY, CABLE, CLUTCH
45	1	87540	PULLEY, 10 X 5/8" (MS)
46	1	88147	KIT, DECAL, SHEET, MS50H
51	1	130550	TRANS, COMPLETE, (MS)
52	1	130670	REAR SUPPORT ASSY

REF #	QTY	PART #	DESCRIPTION
53.1	1	130698	HANDLEBAR-RH, BLK
53.2	1	313786	HANDLE GRIP, 1
53.3	1	336683-SD	CLUTCH LEVER - PAINT (MS)
53.4	1	87372	POST, BINDING, 0.25 X 1.25, ZINC
53.5	1	87425	BOLT, MS #10-24 X 3.125 MS ZP
54.2	1	313786	HANDLE GRIP, 1
54.3	1	130699	HANDLEBAR-LH, BLK
56.1	1	500102	CROSS BRACE - PAINT (MS50H)
56.2	1	88148	DECAL, CROSSBRACE
57	1	500103	ASSY, GUARD, BELT, MS50H
58.2	1	162067	BELT GUIDE - PAINT
58.5	2	80196	5/16 LOCK WASHER - ZINC
58.6	2	86667	BOLT,HHCS,5/16-24 X 3/4,GR5,ZINC
58.11	1	87332	2 X 3/4 C/SHAFT PULLEY
58.12	2	87268	5/16-18 X 5/16 SETSCREW ZN
58.13	1	87373	NUT, CLIP, 1/4-20, 0025-015, BLACK
58.14	1	86454	KEY-SQUARE 3/16 X 1
58.15	2	80205	5/16 SAE FLAT WASHER - ZINC
58.16	1	88146	HONDA ENG. HORIZ. GC160
59.1	1	500085	WHEEL YOKE ASSY -PAINT (PARTS)
59.2	2	162031	WHEEL, 10" X 1.75" (REG)
59.5	2	359330	WHEEL SHOULDER BOLT 2 5/16"
59.6	2	444719	NUT, JAM, NYLOCK, 3/8" NC, ZN
60	1	162069	IDLER SHAFT, TILLER
61	1	336676	R.H. SUPPORT - PAINT (MS,GM)
62	1	336677	L.H. SUPPORT - PAINT (MS,GM)
63	1	336685	DEPTH BAR - PAINT (MS)
64	4	359311	SPACER, TRANS
65	1	359321	IDLER PULLEY, 2-1/4" X 3/8"
66	1	359325	LEVER, IDLER - CUT/PUNCH
67	2	359339	BRACE - PAINT
68	1	359340	BRACKET,LOWER B/GUARD-PAINT
69	1	359343	BRACKET UPPER BG MS
70	1	500006	L.H. FRAME RAIL ASSEMBLY
71	1	500007	R. H. FRAME RAIL
72	4	87460	BOLT-HF-5/16-18 X 1.5 Gr5 Z
73	8	87463	NUT, NYLOCK, FLG, 5/16-18, GRF, ZP
75	1	87373	NUT, CLIP, 1/4-20, 0025-015, BLACK

## 3.2 Transmission Parts Breakdown

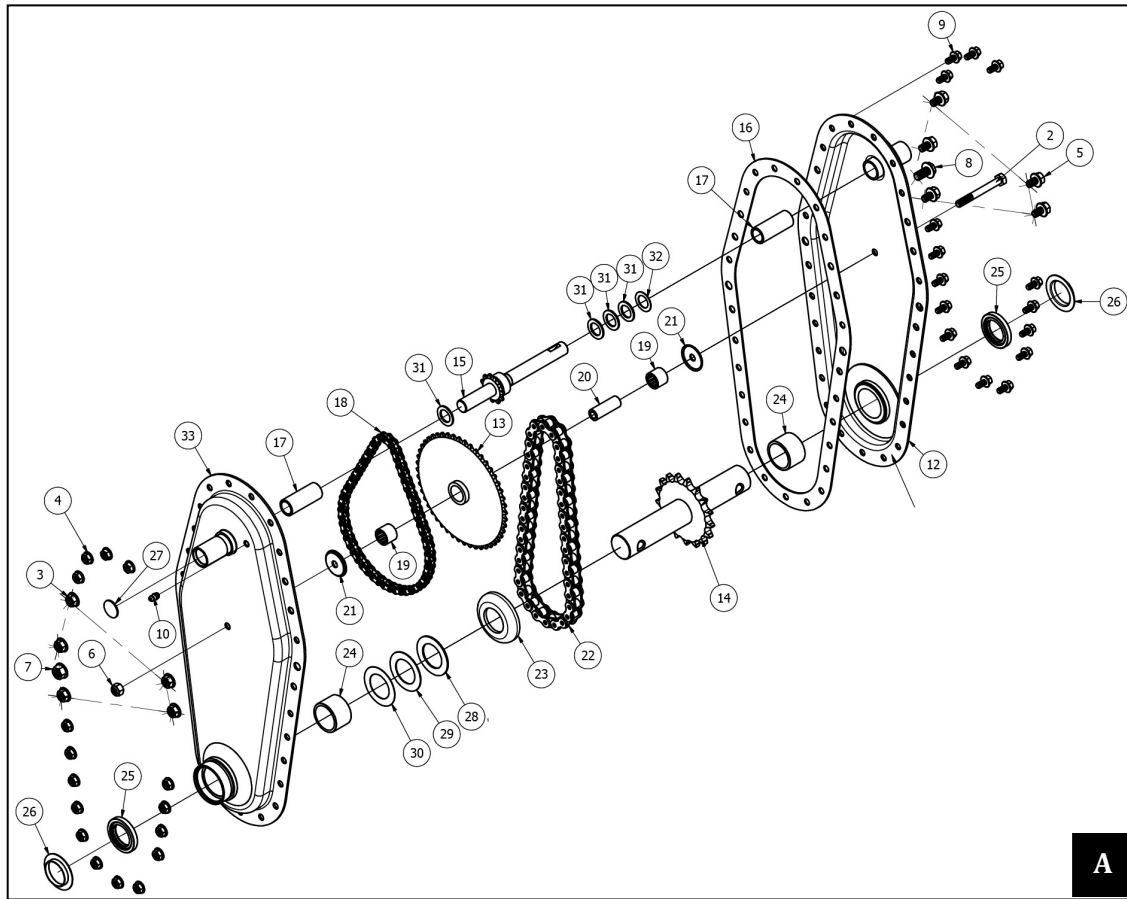

REF	QTY	P/N	DESCRIPTION
<b>A</b>	<b>1</b>	<b>130550</b>	<b>COMPLETE TRANSMISSION</b>
1	A/R	59354	SEALANT, GASKET, BRUSH-ON
2	1	80045	BOLT, HHCS, 5/16-18 X 2 3/4, GR5, ZINC
3	5	80150	5/16-18 SERRATED FLANGE NUT
4	16	85017	1/4-20 SERR. FLG NUT ZP
5	5	86022	BOLT, HHFB, 5/16-18 X 0.50, GR 5, Z
6	1	86101	5/16 NYLON LOCK NUT
7	1	86104	NUT, SFLNG, 3/8-16, ZINC
8	1	87062	BOLT, HHSF, 3/8-16 X 0.75, GR 5, Z
9	16	87558	BOLT, HHFB, 1/4-20 X 1/2, GR5, ZINC
10	1	88113	ZERK, GREASE 1/4-28
11	18OZ	88115	GREASE, LITHIUM NLGI#0
12	1	130697	LH CASE SIDE -REAM, PRES, SPTWLD
13	1	162024	IDLER SPROCKET CLUSTER (MS, GM)
14	1	162025	OUTPUT SHAFT/SPROCKET ASSY (MS,
15	1	162039	INPUT SHAFT/SPROCKET (35A11) MS
16	1	336674	GASKET, CASE (GM.MS)

REF	QTY	P/N	DESCRIPTION
17	2	359293	BUSHING, INPUT (AA811) <BRONZE>
18	1	359295	CHAIN, #35 X 58 LINKS (MS, GM)
19	2	359297	IDLER BEARING, #SCH912 (MS/GM)
20	1	359298	BUSHING, IDLER CLUSTER (MS/GM)
21	2	359299	WASHER, TRANSMISSION -FORM (MS
22	1	359300	CHAIN, #50 X 40 LINKS (MS ,GM)
23	1	359303	OUTPUT SHAFT SPACER-FORM (MS/TP
24	2	359304	BEARING #SCE2016, OUTPUT SHAFT
25	2	359305	OIL SEAL. OUTPUT SHAFT (MS/TP)
26	2	359306	DUST SHIELD -FORM (MS. GM, MT, TP
27	1	359310	PLUG, EXPANSION
28	A/R	359313	WASHER,.062 X 2OD X 1.265"ID"
29	1	359314	WASHER,.0375 X 2"OD X 1.265"ID
30	A/R	359315	WASHER, .020 X 2"OD X 1.265"ID
31	A/R	455049	WASHER, SHIM 41/64 X 1 X .0625
32	A/R	455062	WASHER, SHIM 41/64"X 1"X .032"
33	1	500090	RH CASE SIDE - WELD SUPP.(MS)

3.3 Tines Parts Breakdown

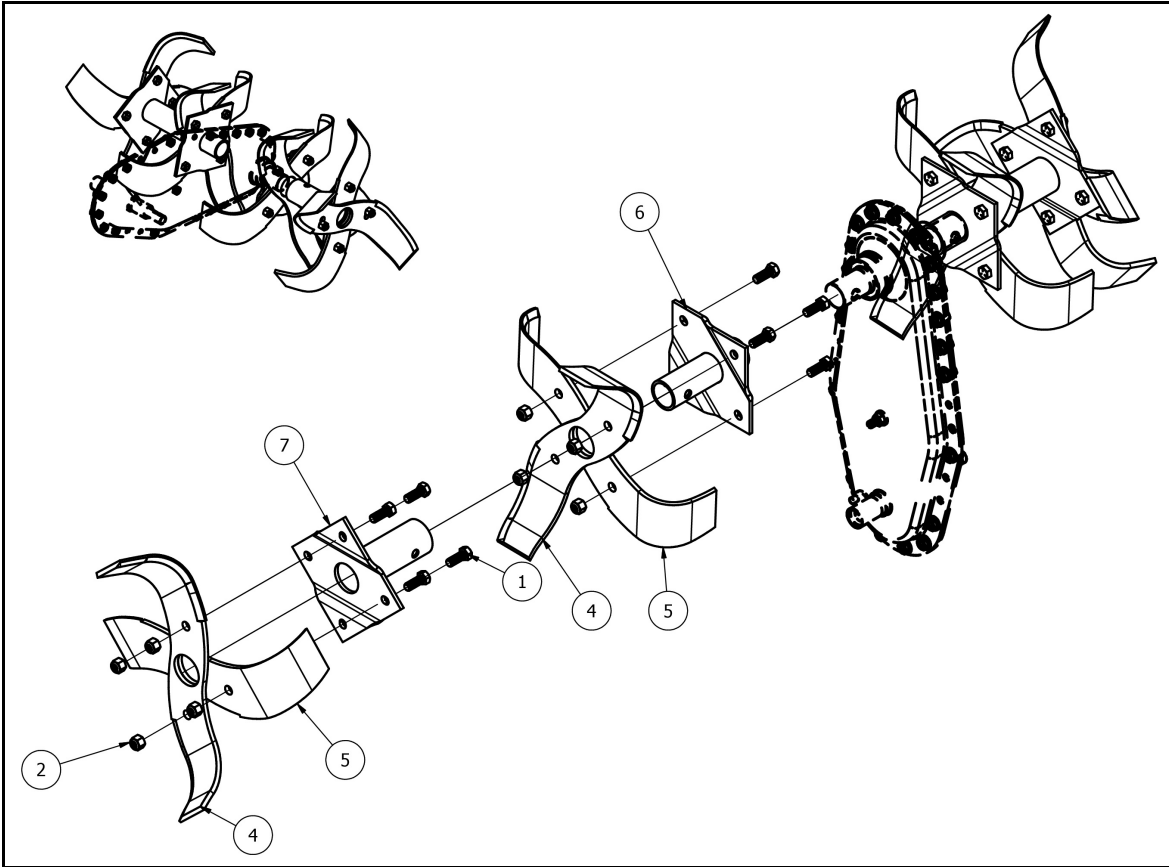

REF #	QTY	PART #	DESCRIPTION
1	16	80049	BOLT, HEX, 3/8-16 X 1.00, ZINC
2	16	86383	NUT, NYLOCK, 3/8-16, GR5, ZINC
4	4	130762	R.H. SLASHER BLADE (GM, MS)
5	4	130763	L.H. SLASHER BLADE (GM, MS)
6	2	130776	INNER HUB - WELDMENT (SLASHER)
7	2	130777	OUTER HUB-SLASHER TINE (PARTS)

### 3.4 General Information

Engine	Honda GC160, 160cc
Transmission	Chain Drive
Tine speed (max)	78 RPM
Tines	Bolt on replaceable tines
Tilling width	14" or 26"
Tilling depth	Up to 10"
Drag Bar	Standard
Handles	1"-14 Gauge Tubular Steel
Hitch	Stamped Hitch with 3/8" x 1-1/2" Drag Stake
Tires	8 x 1.75 (for transport only)
Dimensions (L x W x H)	55" x 26" x 40"
Shipping weight	130 lbs.

## 4 ASSEMBLY

Prior to assembling your tiller, make sure that you have a clear workspace and that there are no missing parts.

1. Remove the tiller from the box. Do not attempt to lift the tiller from the box. After opening the top, remove manuals, protective packaging and all unassembled parts including the parts bag. Note location of cross brace, carefully remove from cardboard. Place these parts off to the side for later assembly. Carefully cut all four sides of the box and lay the sides flat on the floor as shown below. While moving through the first few steps of assembly, temporarily leave the tiller resting on the top of the box containing the tines.



2. Stabilize as needed and prop/block up the transmission approx. 1" – 1 ½" from the ground, by using the cardboard box used to box the Cross brace or a piece of wood.

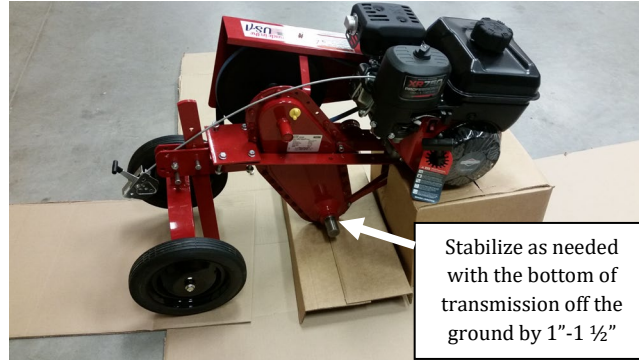

3. Install right and left handle bars to hitch/frame assembly using the four 5/16" x 2" hex bolts, washers and nylon lock nuts, pre-installed in mounting holes. The mounting support plate for wheels and drag bar goes between the frame and handles. Note illustration below: Be sure the right handle, (A) has the clutch engagement lever on it. Place this handle on the right side, as you stand in an operating position.
4. On the left rear mounting bolt, incorporate the Lower Belt Guard support bracket under the frame as shown, bottom right image:

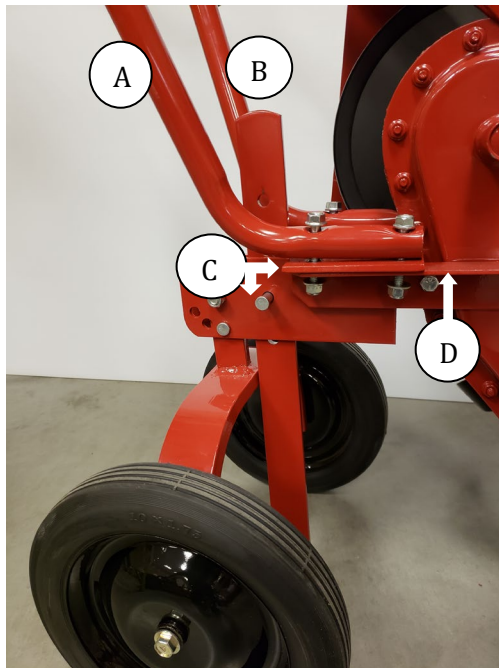

- A- Right handle with lever
- B- Left handle
- C- Mounting support plate
- D- Tiller frame

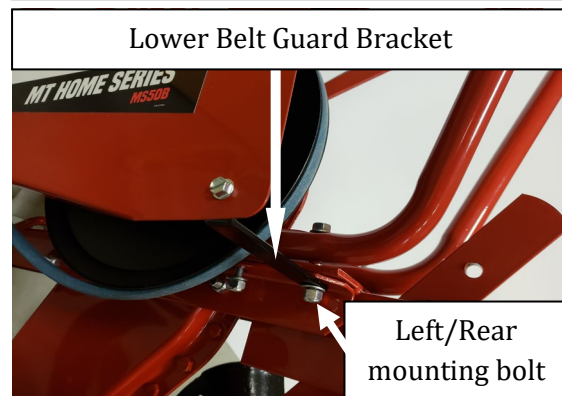

- Once all handle mounting bolts are in place, only partially tighten them, do not fully tighten until all the remaining mounting hardware for the tie and cross brace, is started with a snug fit.
- Install the two handle bar tie braces (A) shown below, to the transmission using two  $\frac{1}{4}$ " x 1" for the top two holes. The first/top one is also used to bolt the belt guard upper bracket (B).
- Using one  $\frac{5}{16}$ " x  $1\frac{1}{4}$ " mount the tie braces and a P-clip/cable guide, in the bottom hole on the right side as shown below:

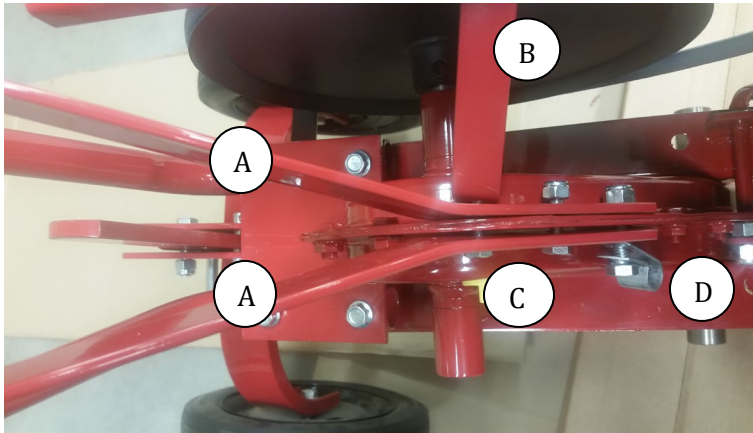

- A- Handle bar tie brace (2)
- B- Upper Belt Guard bracket
- C- Two  $\frac{1}{4}$ " bolt and lock nuts
- D- One  $\frac{5}{16}$ " bolt, lock nut, and P-clip/cable guide

- Fasten the top end of the handle bar braces to the handle bar with the Cross brace using one  $\frac{5}{16}$ " x  $1\frac{3}{4}$ " bolt and lock nut on the right side and one  $\frac{5}{16}$ " x 2" bolt and lock nut on the left side incorporating the top hole of the Manual tube. For the lower end of handle bar tie brace and cross brace use two  $\frac{5}{16}$ " x  $\frac{3}{4}$ " bolts and lock nuts. The lower right mounting bolt will also incorporate a P-clip. Use  $\frac{1}{4}$ " x  $\frac{1}{2}$ " self-tapping bolt to secure the bottom of the manual tube as shown:

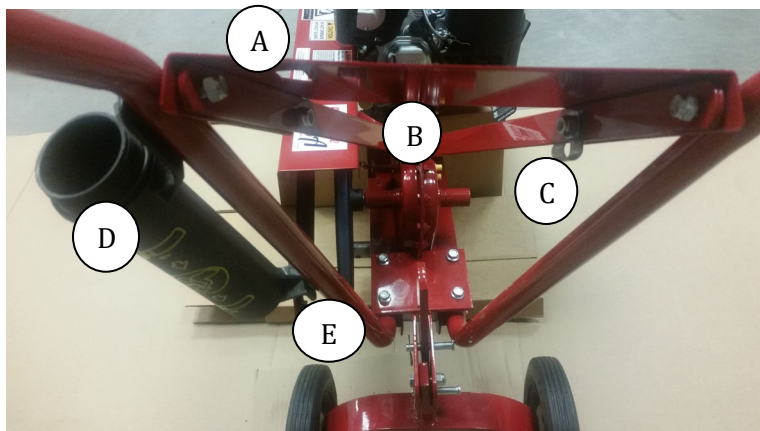

- A- Cross Brace
- B- Handle Bar Tie braces (2)
- C- P-clip
- D- Manual tube
- E-  $\frac{1}{4}$ " self-tapping lower bolt mount

9. Tighten all bolts a little at a time going from one to the next, moving around in a crisscross pattern until they are all tight.
10. Install clutch cable through cable guides and ensure both clutch cable guides are adjusted accordingly, for smooth clutch cable action. Hook loop end of the cable at bottom into notch of clutch arm, see left image below. At the top end of the clutch cable, see right image below, and hook one end of spring into chain and the other into hole in clutch lever. The clutch cable should be adjusted so that the spring will be extended  $\frac{1}{4}$ " –  $\frac{1}{2}$ " when lever is engaged however making certain the belt will slip and tines stop turning, when the lever is released.



11. Your tiller is now ready to mount the tines. Use caution and slowly tip the unit back to rest on the handle bars:





12. Use caution when assembling the tines to the tiller. A second person is recommended to help stabilize the tiller during this step. Assemble the inner tine assemblies on the shaft of the transmission. You may need to use a mallet to gently tap tine assemblies onto tine shaft. The long end (A) of the tube/hub goes to the outside of unit for the 2<sup>nd</sup> outer tine mount, The Short end (B) of the tube/hub goes to the inside near the transmission.

Be sure the cutting edge of all the tines, face forward in the direction of the tine tilling rotation.

Secure with clevis and hair pins

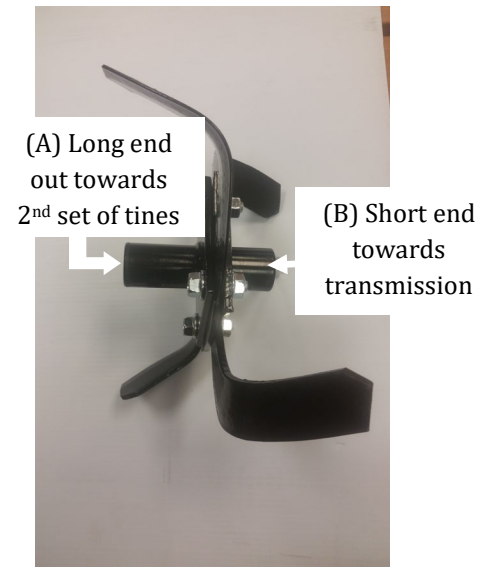

13. Once tines have been mounted and pins inserted, unit can be brought upright, to rest on the tine assembly and wheels.

#### 4.1 Final Set-up

1. Check the transmission to ensure that it has the proper amount of lube
  - a. Remove check plug.
  - b. Use 90 wt. gear lube. Approx. 1 pt.
  - c. Fill until check plug hole overflows.
  - d. Replace plug. NOTE: do not overtighten.
2. Remove the engine dipstick and fill crankcase with oil, according to engine owner's manual.

**NOTE: Engine is shipped from factory without oil. You must add engine oil before starting engine. If engine is started without oil, engine may be damaged beyond repair and will not be covered by warranty.**

3. Fill the fuel tank with clean, fresh, lead-free gasoline. Do not fill fuel tank completely, allow space for fuel to expand. **DO NOT MIX OIL WITH GASOLINE.**



## 5 OPERATING CONTROLS

### 5.1 Speed

1. The tiller will dig deeper and move forward slower by pushing down on the handles.
2. The tiller will move ahead faster, but at a shallower depth, by raising the handles.
3. The speed of the tines is controlled by the throttle control lever located on engine.

### 5.2 Depth of Tilling

1. The proper throttle speed and correct up and down hand pressure on the handles must be used to accomplish a quality till while accommodating operator ability/safety.
2. Raising up means going forward, this action releases the grip of the drag stake in the soil, allowing the tiller to progress ahead.
3. Pushing down means slowing down or even standing still. This directs the drag stake into the soil, thus holding the tiller back.
4. Adjust throttle for desired speed and depth of tines.

### 5.3 Throttle Control Lever Located on Engine

The throttle control lever, located on the engine, will adjust the RPM of engine to the desired engine speed. When starting, place control lever in center position. Once engine is warm, adjust speed, that will turn tines for tilling but also will move the tiller ahead at a safe pace for the operator. To stop engine, move throttle control lever to low idle position. Push ignition on/off switch to off also located on engine.

### 5.4 Engage Lever

The clutch is disengaged when clutch lever is away from handle grip. To engage clutch, depress clutch lever to handle.

## 6 OPERATION

### 6.1 Before Operating

1. Check your tiller. Be sure all bolts are tight. After several hours of operating and at periodic maintenance intervals, check all fasteners and tighten securely as required.
2. Check oil and fill according to the engine owner's manual.

**⚠ WARNING: Engine is shipped from factory without oil. You must add engine oil before starting engine. If engine is started without oil engine may be damaged beyond repair and will not be covered by warranty.**

3. Read engine manual for full instructions and safety warnings.

4. Place tiller on level ground.
5. Remove dipstick. Wipe with clean cloth.
6. Reinsert dipstick (do not screw dipstick back in). Remove dipstick and check.
7. Oil should be at FULL level.
8. If oil is required, add slowly. Recheck level.
9. Change oil if contaminated.
10. Tighten dipstick and clean around oil fill area before starting.
11. Fill engine with clean unleaded gasoline according to the engine owner's manual.

**⚠ WARNING:** Gasoline is flammable. Use caution when handling or storing gasoline. Never fill the gas tank while the engine is running or hot. Do not fill fuel tank completely, allow space for fuel to expand. Allow the engine to cool before adding gas. Clean any spilled gasoline.

12. Ensure that the air element/filter and seal are installed properly. Clean and maintain according to engine owner's manual.
13. Familiarize yourself with all operating controls.

**⚠ DANGER:** Never operate the tiller without proper guards, plates, or other safety devices in place. Serious injury or death could result.

**⚠ WARNING:** Do not attempt to start or operate this tiller until you are completely familiar with location and use of each control necessary to operate this tiller. You must know how to stop this machine before you start it. Each time prior to starting, check the throttle control lever, located on engine, to ensure it is working properly.

## 6.2 Starting the Engine

Before starting the engine, check the machine against the Set-Up instructions (section 4) to see that it is properly assembled. Review the safety suggestions and operating instructions for safe and proper use of the tiller.

## 6.3 Pre-Start

1. Check the spark plug wire for proper connection on the spark plug.
2. Check the oil for proper level.
3. Make certain clutch lever is in disengaged position.

## 6.4 Filling Fuel Tank

We recommend the use of clean, fresh, lead-free gasoline. The use of lead-free gasoline results in few combustion deposits and longer valve life. Do not fill fuel tank completely, allow space for fuel to expand. Provide approximately ¼" of tank space for fuel expansion.

1. Shut-off engine and allow engine to completely cool before refilling the fuel tank.
2. Move to a well-ventilated area, outdoors, away from flames and sparks.
3. Clean debris from area around the fuel cap.
4. Loosen fuel cap slowly. Prevent the cap from coming in contact with dirt or debris.
5. Carefully add fuel without spilling.
6. Do not fill gas tank completely full, allow space for fuel to expand.
7. Immediately replace fuel cap and tighten. Wipe off spilled fuel to allow it to dry before starting engine.



## CAUTION

**ENGINE IS SHIPPED FROM FACTORY WITHOUT OIL. YOU MUST ADD ENGINE OIL BEFORE STARTING ENGINE. IF ENGINE IS STARTED WITHOUT OIL, ENGINE MAY BE DAMAGED BEYOND REPAIR AND WILL NOT BE COVERED BY WARRANTY.**

**NEVER STORE ENGINE WITH FUEL IN THE TANK INDOORS. FUEL AND FUEL VAPORS ARE HIGHLY FLAMMABLE.**

**AN ADULT ONLY MUST ALWAYS HANDLE AND FILL THE ENGINE WITH FUEL.**

**ALWAYS HANDLE GAS IN A WELL-VENTILATED AREA, OUTDOORS, AWAY FROM FLAMES OR SPARKS.**

**DO NOT START ENGINE IF FUEL IS SPILLED. WIPE OFF EXCESS FUEL AND ALLOW TO DRY. REMOVE ENGINE FROM AREA AND AVOID SPARKS.**

## 6.5 Checking and adding Oil

1. Be sure the engine is located on a level surface before checking or refilling oil. Clean around oil fill area.
2. Be sure engine is cool.
3. Unscrew dipstick and wipe clean with cloth.
4. Reinsert dipstick (do NOT thread in for accurate reading).
5. Remove and check dipstick. If no oil shows on the dipstick, refill so that the oil level appears between the low and high marks on the dipstick.
6. Change oil if contaminated.

**\*NOTE: See engine Owner's Manual for proper oil maintenance instructions**

**⚠ IMPORTANT**

**ENGINE MUST BE ON LEVEL SURFACE WHEN CHECKING OIL LEVEL OR FILLING WITH OIL. FAILURE TO DO SO CAN RESULT IN OVERFILLING THE ENGINE WITH OIL WHICH WILL IMPAIR THE ENGINE'S PERFORMANCE.**

**6.6 Cold Starting Procedure**

1. Move throttle control lever, located on engine, to the center position.
2. Move choke control to choke position. Hold the handle with your left hand while pulling the starter rope with your right. Pull the rope out slowly until the engine reaches the start of the compression cycle (the rope will pull slightly harder at this point). Then allow the rope to retract fully.
3. Pull the rope with a continuous full arm stroke. Keep a firm grip on the starter handle and let the rope rewind slowly. Do not let the handle snap back against the recoil starter.
4. Repeat steps number 2-3 above until engine starts. If engine fails to start after 3 pulls on the rope, repeat step number 1-2 above as necessary. Slowly move choke control to RUN position after engine has responded and engine warms up.
5. As the engine warms up, move the throttle lever, located on engine, to full throttle position. Allow engine warm-up period before operating tiller.

**⚠ NOTE:** A warm engine may start without choking. Do not use the choke if engine is hot.

**6.7 Stopping Engine**

1. Move the throttle control, located on engine, to slow/idle position.
2. Turn ON/OFF switch to off position located on engine.
3. Disconnect the wire from the spark plug to prevent accidental starting of the machine while it is unattended.

**6.8 Operation**

**⚠ IMPORTANT:** Keep hands clear of belt and tines while engine is running.

**⚠ WARNING:** For safe operation, the chain drive must disengage immediately when clutch lever is released. If it does not, adjust belt and cable tension as described in Section 7 in this manual.  
**Never leave the tiller unattended with the engine running.**

** DANGER**

**To prevent personal injury, the chain drive must disengage immediately when clutch lever is released. If it does not, stop the tiller, adjust belt and cable tension as described in Adjustments section of this manual. Never leave the tiller unattended with the engine running. Children are attracted to a running tiller and could be injured if struck by the rotating tines.**

** WARNING**

**Keep hands clear of belt and tines while engine is running. Never attempt to adjust or clean tines while engine is running, at risk of sever injury.**

1. When ground is hard (especially during spring and fall tilling season), place wheels in up position by pulling the locking pin from the wheel yoke and repositioning the wheel frame bar, re-insert the pin to reposition and lock wheels in the up position. For weeding or cultivation, wheels may be left down if you prefer.
2. Adjust the drag stake for comfortable operation. This is done by pulling the locking pin from the drop stake locking hub and sliding the drag stake down or up. The drag stake should be set so that when it is firmly in the ground, and your hands are on the tiller handle, your arms hand comfortably with the elbows slightly bent. Once determined re-insert locking pin.
3. Move the throttle control, located on engine, to center position. Start the engine and allow it to warm up, then set the throttle at about half speed. After you have become familiar with the tiller, you may want to run the engine a little faster.
4. Press down firmly on the handles and squeeze the clutch lever. The tines will begin to turn, but the tiller should not move forward. If it does, don't pull backwards – merely press down harder on the handles. When you find the right amount of downward pressure so that the tines are beginning to dig however not moving forward, release the pressure slightly. As you release it, the tiller beginning to move forward.

** NOTE:** The whole tilling operation is controlled by the amount of pressure you put on the drag stake. Do not fight the tiller. Stand between the handles and press down to go slower and dig deeper and release the downward pressure to move forward faster. In normal soil, the actual up and down movement of the handles will be no more than an inch or two.

## 6.9 Operation Tips

To acquire the knack of letting the tiller do the work without effort on the part of the operator, we offer the following suggestions:

1. Adjust drag stake so the handles are at such a height that your arms hang straight down to contact them. Rear wheels should be in up position for deep tillage or ease of turning in confined areas.
2. Operate the tiller at about  $\frac{3}{4}$  throttle located on engine.
3. Don't hurry the job – proceed at a slow walk – give the machine time to do its job.
4. Concentrate on keeping your arms relaxed (There is a natural tendency for any beginner to tense up). Operating the tiller actually takes very little effort. Let the tiller do the work.
5. When tilling on sloping ground, turn the front of the machine uphill to sufficiently counteract the tendency to run downhill.
6. For best results, operate at reduced throttle settings when ground is extremely hard or rough.
7. Tighten all nuts and bolts periodically.

## 6.10 Tilling Pattern

1. Whenever possible till the soil in the direction in which the planting or rows will run. If the soil is extremely hard and dry, it may be advisable to till across the plot on the first digging and then obtain the depth you want by tilling in the direction the planting will be done.

# 7 ADJUSTMENTS

## DANGER

**To avoid possible serious bodily injury, when performing any adjustments, remove the spark plug wire and place the wire away from the plug to prevent accidental starting.**

## 7.1 Clutch Adjustment

Proper clutch adjust is very important. Minor adjustment, if needed, can be made by using the links on the clutch cable chain only. However, the friction type clutch may need further adjustments as the “V” belt wears. Adjust as follows:

1. Remove belt guard.
2. Loosen 4 engine mount bolts. Slide engine forward or backwards as required.
3. Unhook clutch cable from load spring.
4. Push upward on idler pulley to take all slack from the drive belt. Distance between the inside of belt at the idler pulley should be between 2 7/8 and 3 1/8 of an inch.
5. Ensure pulleys are aligned with a long straight edge.
6. Retighten engine mounting bolts (17 foot lbs. of torque).
7. Remove all the slack from clutch cable and hook spring in proper chain link.
8. Check your adjustment by starting the tiller and holding the tines off the ground. If the tines turn without any hand pressure on the engage lever, the adjustment is too tight. Unhook the clutch load and hook into next chain link to lengthen clutch cable. If the cable spring on the clutch handle doesn't stretch when you hold the clutch handle all the way in, the adjustment is too loose. Unhook spring end from chain and hook next link to shorten clutch cable.

## 7.2 Wheel Height Adjustment

1. Wheel position may be adjusted. To place wheels in up position, pull the locking pin from the wheel yoke and repositioning the wheel frame bar re-insert pin to reposition and lock wheels in the up position. For weeding or cultivation, wheels may be left down if you prefer.

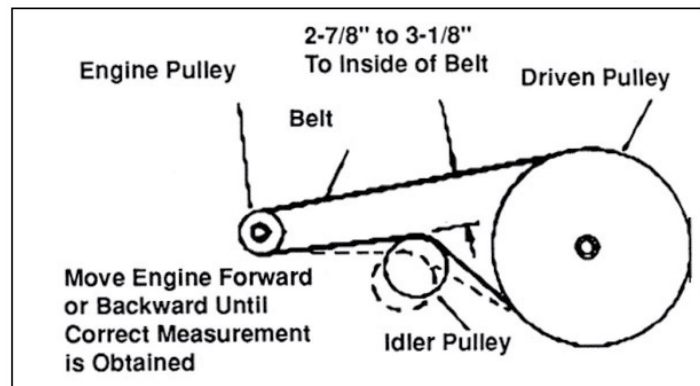

## 7.3 Tine Adjustment

The standard tilling width is 26" with both inner and outer tine assemblies mounted. Tilling width is 14" with outer assemblies removed.

1. To remove outer tine assemblies from inner tine assemblies, remove pin clip from clevis pin.
2. Slide clevis pin out and remove outer tine assembly.

### **⚠ DANGER**

**To avoid possible serious bodily injury, when performing any adjustments, remove the spark plug wire and place the wire away from the plug to prevent accidental starting.**



## 8 Maintenance

**⚠ DANGER:** To avoid possible serious bodily injury, when performing any adjustments, remove the spark plug wire and place the wire away from the plug to prevent accidental starting.

### 8.1 Periodic Check

1. Regularly check all bolts and nuts for tightness.
2. If the belt begins to bottom out on the engine pulley, then replacement of the pulley is needed. This is noticeable by the pulley “V” bottom becoming shiny.

### 8.2 Engine Oil

1. Check the oil level before starting the engine and after every five hours of operation.
2. Be sure engine is cool.
3. Before removing the filler plug, clean the area around it to prevent dirt from entering the oil fill hole.
4. The engine should be in a level position when checking the oil.
5. Remove the filler plug and fill the crankcase with oil.
6. Use a high-quality detergent oil – refer to your engine owner’s manual for oil requirements.
7. Add oil as necessary to keep oil level as indicated. Detergent oils keep the engine cleaner and reduce the formation of gum and varnish deposits. Nothing should be added to the recommended oil.
8. Change the oil after the first 20 hours of operation and every 100 hours there-after or every 6 months, whichever comes first. Always change oil while the engine is warm. Oil may be drained through the oil drain port towards the bottom of the engine. Refer to your Engine Owner’s Manual for complete details.

### 8.3 Dual Filter Element Air Cleaner

Clean cartridge at three month intervals or every 50 hours, whichever occurs first.

**⚠ NOTE:** Service more often under dust conditions.

1. Remove the wing nut from the air cleaner cover and remove cover.
2. Remove the wing nut from the air filter and remove the filter.
3. Remove the foam filter, if equipped, from the paper filter.
4. Inspect both air filter elements and replace them if they are damaged.
5. Always replace the paper air filter element at 300 hours.
6. Re-install filters making certain all seals and gaskets are in properly installed.

**⚠ NOTE:** Replace or clean cartridge included with DUAL ELEMENT AIR CLEANER yearly or every 300 hours as described in CARTRIDGE AIR CLEANER. Service more often if necessary.

## 8.4 Cleaning the Cooling System

1. Remove blower housing and clean regularly.

**⚠ NOTE:** Grass or chaff may clog cooling system after prolonged service. Continued operation with a clogged cooling system causes severe overheating and possible engine damage.

## 8.5 Belt Replacement

The drive belt located on the left side of the machine. To replace a worn or slipping belt proceed as follows:

**⚠ DANGER:** To avoid possible serious bodily injury, when performing any adjustments, remove the spark plug wire and place the wire away from the plug to prevent accidental starting.

1. Remove belt guard.
2. Make sure clutch lever is in disengaged position.
3. Start at the top of 10" pulley and begin removing belt in clockwise direction (facing tiller from left side). If tension on belt is too great the idler pulley may be pulled downward to relieve pressure on belt.
4. Once belt is off the 10" pulley, remove it from smaller pulley.
5. Replace belt by reversing sequence of steps above.
6. Replace belt guard.

## 8.6 Cleaning

**⚠ IMPORTANT:** If the engine has been running, allow it to cool for at least half an hour before washing.

1. Wash the tiller, including the underside, after use.
2. Wash the engine by hand, be careful to prevent water or debris from entering the air cleaner.

**⚠ NOTE:** Do not use a garden hose or pressure washing equipment, it can force water into the air cleaner. Water in the air cleaner will soak the filter element and can enter the carburetor or engine cylinder, causing damage.

3. After washing the tiller, wipe dry.
4. After the tiller is clean and dry, touch up any damaged paint and coat other areas with a light film of oil.
5. Wipe the tines with oil or spray to prevent rusting.

## 9 LUBRICATION

### 9.1 Wheels

Lubricate wheels and wheel support shafts once a month or every 40 operation hours with #30 oil. Apply oil to axle and hub at back of wheel. Spin to allow oil to move into bearings.

In extremely dusty conditions, wheels may become tight because of dust in bearing area. When this condition occurs, remove the wheels. Clean axle and wheel bearing surfaces with solvent or emery cloth, then oil and reassemble.

### 9.2 Clutch Lever Pivots

Apply a Few drops of SAE 30 oil to the clutch hand lever and idler lever pivots as required to maintain a free and smooth operation of clutch.

### 9.3 Transmission

Transmission grease zerk is located on the upper right-hand side. Use Lithium NLGI "0" grease when servicing the transmission. Annually, add grease if needed, being mindful not to overfill and by pass lower shaft seals. If excessive grease seepage appears around tine rotor shaft, then replace the output shaft seals and shields. Disassembly of transmission is not required to replace the output shaft seals and shields. Should disassembly be required, please note: 1) Use shims 359313, 359314, 359315 as required for output shaft fitment. 2) Use shims 455062, 455049 as required for input shaft fitment. 3) Add 20 oz of grease to inside of case once all components are installed. 4) Torque cover fasteners to 8 ft-lbs. (96 in-lb.)

Note: Use part # 109386.MAX grease for service and maintenance. Other greases may not be compatible and cause damage to the transmission and void warranty.

### 9.4 Idler Arms Pivot

Lubricate idler arm pivots once a month or every 40 operating hours with dry spray lube or a small amount of #30 oil.

## 10 STORAGE

### 10.1 Engine

1. If your tiller is to be stored over 30 days, please see your Engine Owner's Manual for storage information. The engine should be completely drained of fuel to prevent gum deposits from forming on essential carburetor parts, fuel filter, fuel lines and tank.
2. Refer to engine manual for further engine storage procedures.

### 10.2 Tiller

1. At the end of the season or if tiller is to be stored for any length of time it should be cleaned following the cleaning instructions in Section 8.6.

## 11 TRANSPORTING

To transport tiller from garden to storage area:

1. Move the throttle control, located on engine, to idle position.
2. Turn ON/OFF switch to **OFF** position, located on engine.
3. Turn fuel supply valve off.
4. Place wheels in down position by pulling the pin from the wheel yoke and repositioning the wheel frame bar then re-insert pin to reposition and lock wheels in the up position.
5. Raise drag stake. This is done by pulling the locking pin from the drop stake locking hub and sliding the drag stake up, then re-insert pin.



## 12 WARRANTY

### 12.1 Warranty/Product Registration

Please register your product immediately after purchase. You can do that by visiting our website at [www.maximmfg.com](http://www.maximmfg.com) and complete our online product registration.

Or, complete the following warranty/production registration form on the next page and return to:

**Maxim**  
 Attn: Warranty Registration Department  
 20195 South Diamond Lake Road, STE 100  
 Rogers, MN 55374



MS50H

Product Registration Form

**YOUR INFORMATION**

Full Name:

\_\_\_\_\_  
Last First M.I.

Address:

\_\_\_\_\_  
Street Address Apartment/Unit #

\_\_\_\_\_  
City State ZIP Code

Home Phone:

\_\_\_\_\_  
Alternate Phone: \_\_\_\_\_

Email

\_\_\_\_\_

**PURCHASED FROM**

Company:

\_\_\_\_\_

Address:

\_\_\_\_\_  
Street Address Apartment/Unit #

\_\_\_\_\_  
City State ZIP Code

**MODEL INFORMATION**

Purchase Date

\_\_\_\_\_

Application Type

Homeowner  Commercial  Rental

Model (i.e. RMT55H)

Serial # (i.e. RMT55HA01234567)

Signature

\_\_\_\_\_

**Register your product online at [www.maximmfg.com](http://www.maximmfg.com)**

**Or, Fax completed form to: 763-428-4821**



20195 South Diamond Lake Road, Suite 100 • Rogers, MN 55374  
 Toll-Free: 800-621-2789 • Website: maximmfg.com • Email: sales@maximmfg.com

**Dear Valued Customer:**

The Maxim Product you just purchased is built with the finest material and craftsmanship. Use this product properly and enjoy the benefits from its high performance. By purchasing a Maxim Product, you show a desire for quality and durability. Like all mechanical equipment this unit requires a due amount of care. Treat this unit like the high quality piece of machinery it is. Neglect and improper handling may impair its performance and is not covered by this limited warranty.

Thoroughly read the instructions and understand the operation before using your product. Always contact Maxim Product Support at 1-800-621-2789 prior to having any service or warranty work performed, as some services performed by parties other than Maxim approved service centers may void this warranty. This limited warranty is in lieu of any other warranty expressed or implied, written or oral and Maxim assumes no other responsibility or liability outside that expressed within this limited warranty.

**Limited Warranty for Maxim Product:  
 Aerators, Lawn Rollers, Plows, Tillers, Trimmers**

*\*Excludes MTC35H Mini Max Tiller/Cultivator, HWP-24WH High Wheel Plow and RT190H Rear Tine Tiller*

	<b>Consumer Warranty Period</b>	<b>Commercial Warranty Period</b>
<b>Weldments</b>	2 years from date of purchase by user	2 years from date of purchase by user
<b>Gear Case</b>	2 years from date of purchase by user	1 year from date of purchase by user
<b>Wear Parts</b>	In addition to the normal warranty, Maxim shall warrant some normal wear items from defects in material or workmanship for a period of 30 days from the date of purchase by user. Normal wear items covered under this warranty are limited to: High impact wear related components such as standard retention hardware for wear items, tines and tine assemblies, seals, seal shields, bearings, bushings, gaskets, belts, roller chain, tires and wheel assemblies, throttle or choke control and cable assemblies, mower and edger blades, mower deck pans. Routine maintenance items such as lubricants, belt adjustments, tune ups, and damage from operation with loose hardware are not covered under limited warranty.	
<b>Engines</b>	The engine warranty is covered under the terms and conditions as outlined by the engine manufactures warranty contained herein and is the sole responsibility of the engine manufacturer. Normal engine maintenance such as spark plugs, oil changes, air filters, adjustments, fuel system cleaning and obstruction due to build up is not covered by this Maxim limited warranty.	

“**Consumer use**” means personal residential household use by a consumer. “**Commercial use**” means all other uses, including, but not limited to, use for commercial, income producing or rental purposes or when purchased by a business.

This limited warranty applies to the original purchaser of the equipment (verification of purchase, in the form of a receipt, is the responsibility of the buyer), is non-transferable, and covers parts and labor. Parts will be replaced or repaired at no charge, except when the equipment has failed due to lack of proper maintenance. If a part is no longer available, the part may be replaced with a similar part of equal function. Any misuse, abuse, alteration or improper installation or operations will void warranty. Determining whether a part is to be replaced or repaired is the sole decision of Maxim. Maxim will not provide for replacement of complete products due to defective parts. Any costs incurred due to replacement or repair of items outside of a Maxim approved facility is the responsibility of the buyer and not covered under warranty. Transportation costs to and from service center and/or service calls are the responsibility of the customer.

This limited warranty specifically excludes the following: failure of parts due to damage caused by accident, fire, flood, windstorm, acts of God, applications not approved by Maxim in writing, corrosion caused by chemicals, use of replacement parts which do not conform to manufacturer’s specifications, damage related to rodent and/or insect infestation and damage caused by vandalism. Additional exclusions: loss of running time, inconvenience, loss of income, or loss of use, including any implied warranty of merchantability of fitness for a specific use. Also, outdoor power equipment needs periodic parts and service to perform well, and this limited warranty does not cover instances when normal use has exhausted the life of a component or the engine.

This limited warranty does not cover any personal injury or damage to surrounding property caused by failure of any part, misuse or inability to use the product. Alteration of the product, including safety features, shall void this limited warranty.



MS50H



---

A GNE BRAND

**Maxim**  
**A Brand of Great Northern Equipment**  
20195 South Diamond Lake Road  
Suite 100  
Rogers, MN 55374  
[www.maximmfg.com](http://www.maximmfg.com)  
800-621-2789