

Pulse™ Metered Dispense Valve

3A5412K

EN

For dispensing oil, automatic transmission fluid (ATF), gear oils, antifreeze and windshield washer solvent* in conjunction with wireless communication with a Pulse Fluid Management system.

Not approved for use in explosive atmospheres or hazardous locations. For professional use only.

See page 6 for model information.

1500 psi (10 MPa, 103 bar) Maximum Working Pressure



Important Safety Instructions

Read all warnings and instructions in this manual and related Pulse System manuals. Save all instructions.

NOTICE

The metered dispense valve is designed to dispense petroleum-based lubricants, windshield washer solvent* and antifreeze only. Brake cleaner and/or harsh solvents may damage the plastic components.

*See Fluid Compatibility in Technical Specifications, page 34.

Related Manuals

- 3A5410 - Pulse Pump Air Control (PAC)
- 3A5411 - Pulse Tank Level Monitor (TLM)
- 3A5414 - Pulse HUB

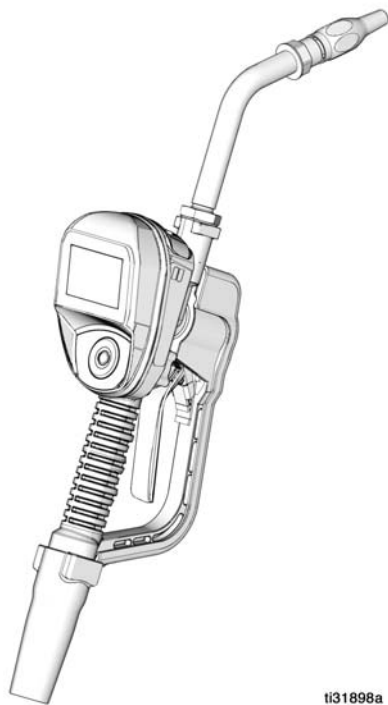

ti31898a

Contains Model XBee S2C Radio, IC: 1846A-XBS2C.

The metered dispense valve contains FCC ID MCQ-XBS2C. This device complies with Part 15 of the FCC Rules. Operation is subject to the following two conditions:

- This device may not cause harmful interference.
- This device must accept any interference received, including interference that may cause undesired operation.

Contents

Warnings	4
Models	6
Metered Dispense Valve Overview	7
Navigation Pad (FIG. 1)	7
Header Information	7
Sleep / Awake Mode	8
Typical Installation	9
Mounting Bracket	9
Oil Bar	9
Installation	10
Pressure Relief Procedure	10
Grounding	10
Pre-Installation Procedure	11
Flushing	11
Install the Metered Dispense Valve	12
Install the Extension Tube	12
Install the Nozzle	13
Set Up	14
Main Menu Screen	14
REGISTER	14
Calibrate the Metered Dispense Valve	15
Alternate Calibration	16
Security Authorization	17
Utility Menu Code	17
PIN Codes	17
Operation	20
Dispense Menus	20
Manual Dispense	20
Preset Dispense	20
Work Orders	23
Setup Menus	24
DEVICE INFORMATION	24
REGISTER	24
SIGNAL TEST	25
GO BACK	25

Utility Menus	26
UPGRADE	26
WORK OFFLINE	26
CALIBRATE	26
MANUAL LIMIT	26
FLIP DISPLAY	26
GO BACK	26
Service	27
Battery Replacement	27
Troubleshooting	28
Error Codes	30
Definition of Terms	30
Parts	32
Parts	33
Related Kits	33
Technical Specifications	34
Graco 5-Year Meter and Valve Warranty	35

Warnings

The following warnings are for the setup, use, grounding, maintenance, and repair of this equipment. The exclamation point symbol alerts you to a general warning and the hazard symbols refer to procedure-specific risks. When these symbols appear in the body of this manual or on warning labels, refer back to these Warnings. Product-specific hazard symbols and warnings not covered in this section may appear throughout the body of this manual where applicable.

WARNING



SKIN INJECTION HAZARD



High-pressure fluid from dispensing device, hose leaks, or ruptured components will pierce skin. This may look like just a cut, but it is a serious injury that can result in amputation. Get immediate surgical treatment.



- Do not point dispensing device at anyone or at any part of the body.
- Do not put your hand over the fluid outlet.
- Do not stop or deflect leaks with your hand, body, glove, or rag.
- Follow the **Pressure Relief Procedure** when you stop dispensing and before cleaning, checking, or servicing equipment.
- Tighten all fluid connections before operating the equipment.
- Check hoses and couplings daily. Replace worn or damaged parts immediately.



EQUIPMENT MISUSE HAZARD

Misuse can cause death or serious injury.



- Do not operate the unit when fatigued or under the influence of drugs or alcohol.
- Do not exceed the maximum working pressure or temperature rating of the lowest rated system component. See **Technical Specifications** in all equipment manuals.
- Use fluids and solvents that are compatible with equipment wetted parts. See **Technical Specifications** in all equipment manuals. Read fluid and solvent manufacturer's warnings. For complete information about your material, request Safety Data Sheets (SDSs) from distributor or retailer.
- Turn off all equipment and follow the **Pressure Relief Procedure** when equipment is not in use.
- Check equipment daily. Repair or replace worn or damaged parts immediately with genuine manufacturer's replacement parts only.
- Do not alter or modify equipment. Alterations or modifications may void agency approvals and create safety hazards.
- Make sure all equipment is rated and approved for the environment in which you are using it.
- Use equipment only for its intended purpose. Call your distributor for information.
- Route hoses and cables away from traffic areas, sharp edges, moving parts, and hot surfaces.
- Do not kink or over bend hoses or use hoses to pull equipment.
- Keep children and animals away from work area.
- Comply with all applicable safety regulations.

WARNING



FIRE AND EXPLOSION HAZARD

When flammable fluids are present in the work area, such as gasoline and windshield wiper fluid, be aware that flammable fumes can ignite or explode. To help prevent fire and explosion:



- Use equipment only in well-ventilated area.
- Eliminate all ignition sources, such as cigarettes and portable electric lamps.
- Ground all equipment in the work area.
- Keep work area free of debris, including rags and spilled or open containers of solvent and gasoline.
- Do not plug or unplug power cords or turn lights on or off when flammable fumes are present.
- Use only grounded hoses.
- **Stop operation immediately** if static sparking occurs or you feel a shock. Do not use equipment until you identify and correct the problem.
- Keep a working fire extinguisher in the work area.



PERSONAL PROTECTIVE EQUIPMENT

Wear appropriate protective equipment when in the work area to help prevent serious injury, including eye injury, hearing loss, inhalation of toxic fumes, and burns. Protective equipment includes but is not limited to:

- Protective eye wear, and hearing protection.
- Respirators, protective clothing, and gloves as recommended by the fluid and solvent manufacturer.

CALIFORNIA PROPOSITION 65

This product contains a chemical known to the State of California to cause cancer, birth defects or other reproductive harm. Wash hands after handling.

Models

Model	Swivel	Extension	Nozzle	Fluid	Max Volumetric Flow Rate	
					GPM	LPM
25M317	1/2 NPT	Rigid	Automatic	Oil	8	30
25M318	1/2 NPT	Rigid	Antifreeze	Antifreeze	8	30
25M319	1/2 NPT	Flexible	Automatic	Oil	8	30
25M320	1/2 NPT	Flexible	Antifreeze	Antifreeze	8	30
25M323	1/2 NPT	Rigid	High Flow	Oil	18	68
25M324	1/2 NPT	Flexible	High Flow	Oil	18	68
25M326	1/2 NPT	Gear Lube	Manual	Gear Lube	5	19
25M328	1/2 NPT	Rigid, open	None	WWS*	8	30
25M329	3/4 NPT	Rigid	High Flow	Oil	18	68
25M330	3/4 NPT	Flexible	High Flow	Oil	18	68
25M332	1/2 BSPP	Rigid	Automatic	Oil	8	30
25M333	1/2 BSPP	Rigid	Antifreeze	Antifreeze	8	30
25M334	1/2 BSPP	Flexible	Automatic	Oil	8	30
25M335	1/2 BSPP	Flexible	Antifreeze	Antifreeze	8	30
25M338	1/2 BSPP	Rigid	High Flow	Oil	18	68
25M339	1/2 BSPP	Flexible	High Flow	Oil	18	68
25M341	1/2 BSPP	Gear Lube	Manual	Gear Lube	5	19
25M343	1/2 BSPP	Rigid, open	None	WWS*	8	30
25M344	3/4 BSPP	Rigid	High Flow	Oil	18	68
25M345	3/4 BSPP	Flexible	High Flow	Oil	18	68
25M347	1/2 BSPT	Rigid	Automatic	Oil	8	30
25M348	1/2 BSPT	Rigid	Antifreeze	Antifreeze	8	30
25M349	1/2 BSPT	Flexible	Automatic	Oil	8	30
25M350	1/2 BSPT	Flexible	Antifreeze	Antifreeze	8	30
25M353	1/2 BSPT	Rigid	High Flow	Oil	18	68
25M354	1/2 BSPT	Flexible	High Flow	Oil	18	68
25M356	1/2 BSPT	Gear Lube	Manual	Gear Lube	5	19
25M358	1/2 BSPT	Rigid, open	None	WWS*	8	30
25M359	3/4 BSPT	Rigid	High Flow	Oil	18	68
25M360	3/4 BSPT	Flexible	High Flow	Oil	18	68

*WWS = Windshield Washer Solvent

Metered Dispense Valve Overview

Metered Dispense Valve Overview

NOTE: The metered dispense valve's operating parameters are controlled by the Pulse Fluid Management Software and set up by the System Administrator.

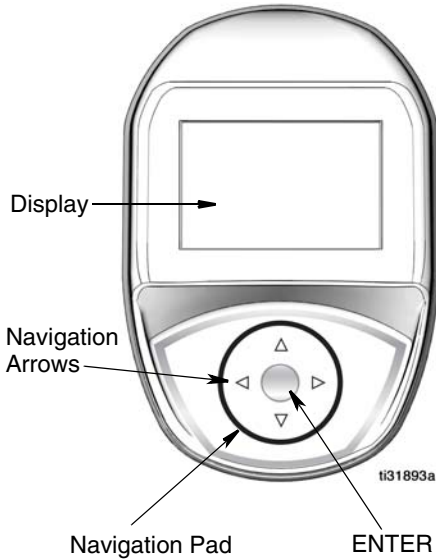

FIG. 1

Navigation Pad (FIG. 1)

The Navigation Pad includes 4 navigation ARROWS (UP, DOWN, LEFT, RIGHT) and a center, ENTER button.

Arrows: Move the cursor on the display.

ENTER button: Used to select or store an entry.

Header Information



FIG. 2

The following information appears at the top of the Work Offline and Dispense screens.

- A Metered Dispense Valve Name - Unique identification. Configured in the Pulse Fluid Management Software.**
- B RF Signal Strength - Displays the strength of the signal received by the metered dispense valve, indicated by the number of bars displayed on the screen.**
- C Battery Indicator - When the batteries are fully charged, the battery is completely filled in. As the battery discharges, the amount of battery that is filled declines. When the low battery symbol shown in FIG. 3 is shown, replace the batteries. See Battery Replacement, page 27.**



FIG. 3

Metered Dispense Valve Overview

Sleep / Awake Mode

- **Sleep:** Battery-saving mode.
- **Awake:** To wake up metered dispense valve, press any ARROW or the center ENTER button on the metered dispense valve's navigation pad.

Locking and Unlocking the Trigger

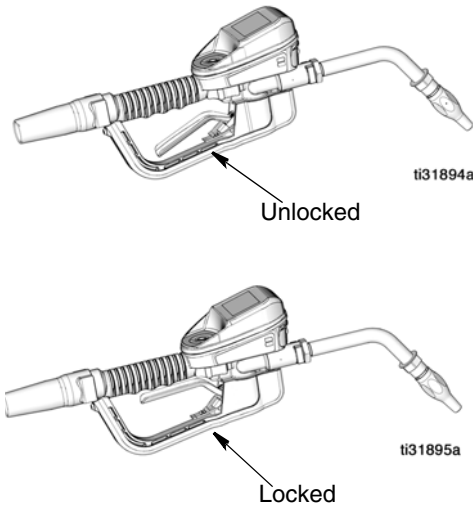

FIG. 4

The locking trigger feature allows the user to lock the trigger in the dispense position as shown in FIG. 4. To release the lock, firmly squeeze the trigger to the handle.

NOTE:

- Do not leave the metered dispense valve unattended during a dispense.
- The locking trigger feature is not available on windshield washer solvent models.

Opening and Closing the Nozzle

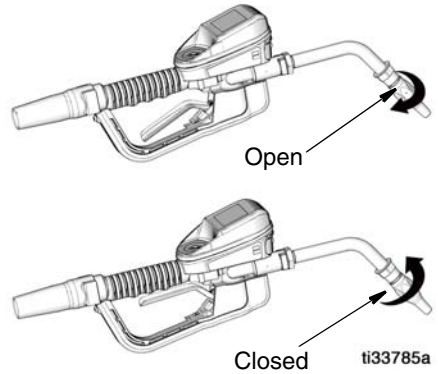

FIG. 5

- To **open** the nozzle, use your hand to rotate the nozzle **clockwise**.
- To **close** the nozzle, use your hand to rotate the nozzle **counter-clockwise**.

Typical Installation

The typical installation shown in FIG. 6 is only a guide. It is not a complete system design. Contact your Graco distributor for assistance in designing a system to suit your needs.

The metered dispense valve is not designed for in-line installation.

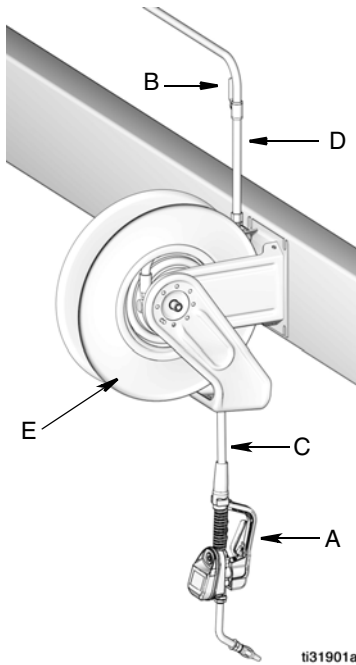

FIG. 6

ITEM	DESCRIPTION
A	Metered Dispense Valve
B	Fluid shut-off valve
C	Hose
D	Hose reel fluid inlet hose
E	Hose reel

A Thermal Relief Kit (not shown) is required. The kit required will vary by pump selected.

Mounting Bracket

Mounting Bracket Kit 249440 is available for mounting the metered dispense valve on a console.

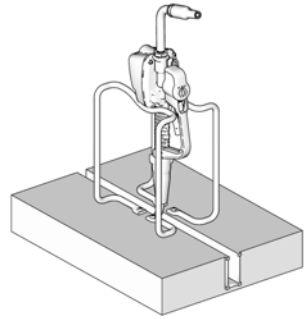

FIG. 7

Oil Bar

An Oil Bar Kit is available for mounting one to three metered dispense valves. Contact your Graco Distributor for ordering details.

NOTE: The Utility Menu provides an option to flip the metered dispense valve display for easy viewing when the metered dispense valve is installed in the Oil Bar.

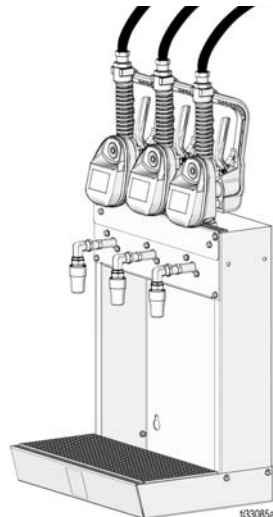

FIG. 8

Installation

Pressure Relief Procedure



Follow the Pressure Relief Procedure whenever you see this symbol.



This equipment stays pressurized until pressure is manually relieved. To help prevent serious injury from pressurized fluid, such as skin injection, splashing fluid and moving parts, follow the Pressure Relief Procedure when you stop dispensing and before cleaning, checking, or servicing the equipment.

1. Turn off power supply to the pump or close fluid shut off valve (B).
2. Open nozzle. Authorize a test dispense within the Pulse Fluid Management software or an off line dispense. Trigger the metered dispense valve into a waste container to relieve pressure.
3. Open any bleed-type master air valves and fluid drain valves in the system.
4. Leave the drain valve open until you are ready to pressurize the system.

Grounding



The equipment must be grounded to reduce the risk of static sparking. Static sparking can cause fumes to ignite or explode. Grounding provides an escape wire for the electric current.

Follow manufacturer's recommendations to ground the **pump** and **fluid supply container**.



FIRE HAZARD

Conductive metal surfaces on the metered dispense valve must not make contact with any positively charged metal surface, including (but not limited to), the starter solenoid terminal, alternator terminal or battery terminal. Such contact could cause electrical arcing and a fire.

To maintain grounding continuity when flushing or relieving pressure: hold a metal part of the metered dispense valve firmly to the side of a grounded metal pail, then trigger the metered dispense valve.

Hoses: Only use electrically conductive hoses. Check electrical resistance of hoses. If total resistance to ground exceeds 29 megohms, replace hose immediately.

Pre-Installation Procedure



1. **Relieve pressure**, page 10.
2. Close shut-off valve (B, FIG. 6, page 9).
3. Ground the hose and reel or console. Leave at least two threads bare when using PTFE tape. The bare threads ensure a ground is maintained.

NOTICE

- If this is a new installation or if the fluid lines are contaminated, flush the lines before you install the metered dispense valve. Contaminated lines could cause the metered dispense valve to leak.
- Never dispense compressed air with metered dispense valve. Dispensing compressed air will damage the metered dispense valve.

4. Flush equipment. See **Flushing**, page 11.

Flushing

The equipment was tested with lightweight oil, which is left in the fluid passages to protect parts. To avoid contaminating your fluid, flush the equipment with a compatible solvent before using it.



1. Close the fluid shut-off valve (B, FIG. 6, page 9) at each dispense position.
2. Make sure:
 - the main fluid outlet valve at the pump is closed.
 - the air pressure to the pump motor is adjusted to minimize the system flow rate without the metered dispense valve attached.
 - the air valve is open.
3. Slowly open the main fluid outlet valve.
 - a. Place the hose end (with no metered dispense valve connected) into a container for waste oil.
 - b. Secure the hose in the container so it will not come out during flushing.
 - c. If you have multiple dispense positions, first flush the dispense position farthest from the pump and work your way toward the pump.
4. Slowly open the shut-off valve (B) at the dispense position. Flush out a sufficient amount of oil to ensure that the entire system is clean; then close the valve.
5. Repeat Step 4 at all other positions.

Installation

Install the Metered Dispense Valve



1. Relieve pressure, page 11.

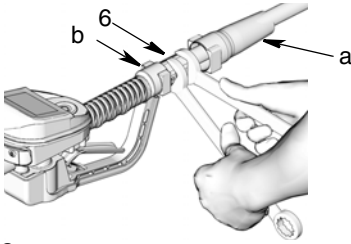

FIG. 9

2. Slide the swivel boot (a) back, over the hose, small end first to access the swivel fitting (6) (FIG. 9).
3. Apply thread sealant to the male threads of the hose fitting. Thread the hose fitting (b) into the metered dispense valve swivel (6). Use two wrenches to tighten securely (FIG. 9).

NOTE: Make sure you let the sealant cure to according to the manufacturer's recommendations before circulating fluid through the system.

Install the Extension Tube

1. Adjust nut (c) on extension (2) so that the maximum thread engagement of the extension can be utilized (FIG. 10).

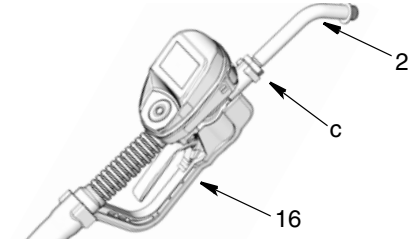

FIG. 10

2. Thread extension (2) into housing until it bottoms out (FIG. 10).
3. Align extension (2) with metered dispense valve housing and handle (16) (FIG. 10).
4. Firmly tighten nut (c) (FIG. 10).

Install the Nozzle

1. Thread nozzle (3) onto extension (2) (FIG. 11).

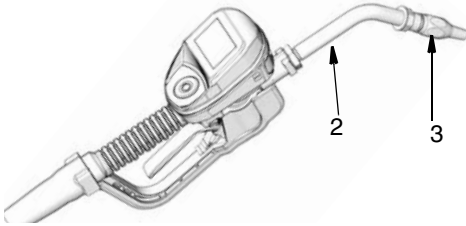

FIG. 11

2. With an open-end adjustable wrench on the flats of the nozzle bushing, tighten firmly (FIG. 12).

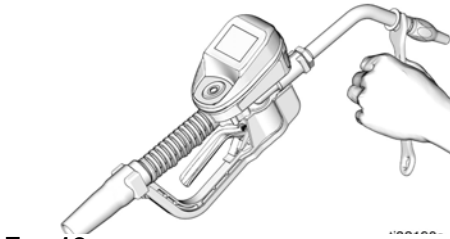

FIG. 12

NOTICE

- To prevent damaging nozzle, *only* tighten nozzle with wrench on flats of the nozzle bushing as shown in FIG. 12.
 - **Do not disassemble the bushing from the nozzle.** Disassembly will affect the performance of the nozzle.
3. Open the automatic twist lock nozzle and all fluid shut-off valves. Start pump to pressurize system.
 4. To ensure dispensing accuracy, purge all air from the fluid lines and metered dispense valve before you use it.
 5. Set the system flow to the desired flow rate. This is typically done by adjusting the pump air pressure.

Set Up

Main Menu Screen

This screen provides access to the main metered dispense valve functions:

- DISPENSE, page 20
- SETUP, page 24
- UTILITY MENU, page 26

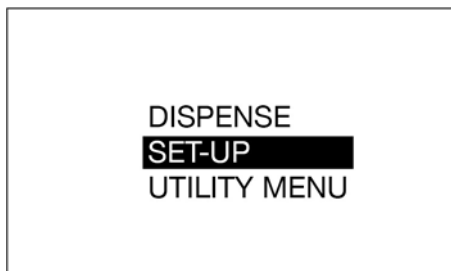

FIG. 13

REGISTER

The metered dispense valve must be registered with the Pulse Fluid Management Software before it can dispense fluid.

1. Put the Pulse Fluid Management Software into DISCOVERY Mode.
2. From the MAIN MENU screen use the UP and DOWN ARROW on the navigation pad to select the SET-UP option.

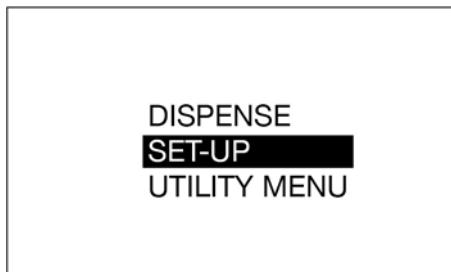

FIG. 14

3. From the UTILITY MENU, use the UP and DOWN ARROW on the navigation pad to select the REGISTER option.

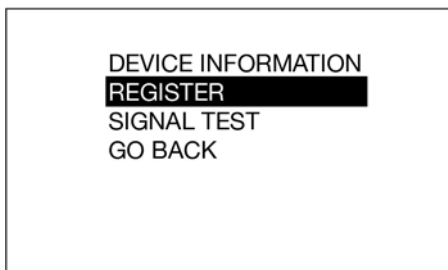

FIG. 15

4. Press the ENTER button. REGISTERING appears in the middle of the display during registration as shown in FIG. 16.

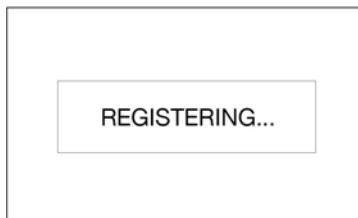

FIG. 16

5. After the metered dispense valve has successfully registered with the Pulse Fluid Management Software, REGISTERED displays (FIG. 17). Then the UTILITY MENU screen displays.

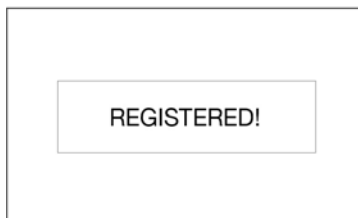

FIG. 17

If the metered dispense valve does not register with the Pulse Fluid Management Software, **FAILED** appears on the display (FIG. 18).

NOTE: If the metered dispense valve fails to register with the Pulse Fluid Management Software, check to be sure the software is in **DISCOVERY MODE** and retry registration.



FIG. 18

Calibrate the Metered Dispense Valve

NOTE: This calibration procedure requires **1 quart or 1 liter**, calibrated, volumetric flask. When the meter is configured to display fluid volume in pints, quarts or gallons, the calibration procedure will require a 1 quart calibrated volumetric flask be used. When the meter is configured in liters, a 1 liter volumetric flask is required for calibration.

The metered dispense valve should be calibrated prior to using it for the first time. Calibrating the metered dispense valve assures you that dispenses are accurate.

Calibration factors can vary due to fluid viscosity and flow rate. Calibrate metered dispense valves for specific fluid at nominal flow rates.

To calibrate the metered dispense valve:

1. If the system is not fully primed, flush the metered dispense valve. See Flushing, page 11.
2. Select the **UTILITY MENU** option (FIG. 19).



FIG. 19

3. Enter the Utility Menu Code.
4. Select the **CALIBRATE** option (FIG. 20) to display the calibration K-Factor screen shown in FIG. 21.

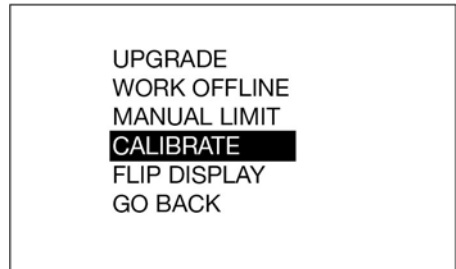

FIG. 20

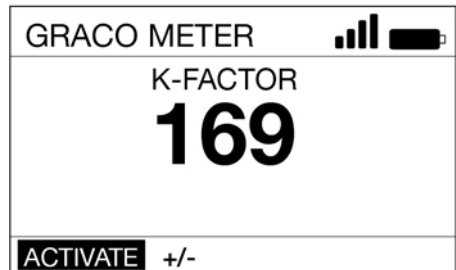

FIG. 21

5. Select **ACTIVATE** and press the **ENTER** button to begin metered dispense valve calibration (FIG. 21).
6. Dispense **exactly 1 quart or 1 liter** of fluid into a clean, calibrated, volumetric flask.

IMPORTANT! The metered dispense valve will not display the volume dispensed. The volume dispensed is

Set Up

only determined by the flask measurement.

- When **exactly 1 quart or 1 liter** of fluid is dispensed into the flask, select END and press the ENTER button. The new calibration factor displays.
- Select END and the ENTER button again to complete the operation and save the new calibration factor.

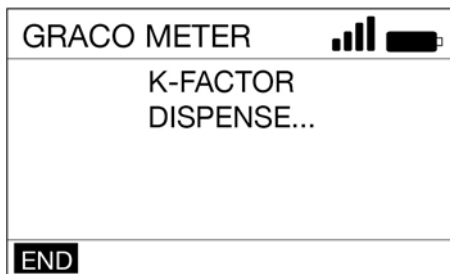

FIG. 22

Alternate Calibration

NOTE: This alternate calibration procedure is used when a **1 quart or 1 liter**, calibrated, volumetric flask is not available.

- If the system is not fully primed, flush the metered dispense valve. See Flushing, page 11.
- Dispense a known volume of fluid into a clean, calibrated, volumetric flask. Note this volume as the VOLUME DISPENSED (see Calculating K-Factor, Step 9, page 17).
- Record the volume displayed on the metered dispense valve. Note this volume as the VOLUME DISPLAYED ON THE metered dispense valve (see Calculating the K-Factor, Step 9, page 17).
- Select the UTILITY MENU option (FIG. 23).



FIG. 23

- Enter the Utility Menu Code.
- Select the CALIBRATE option.

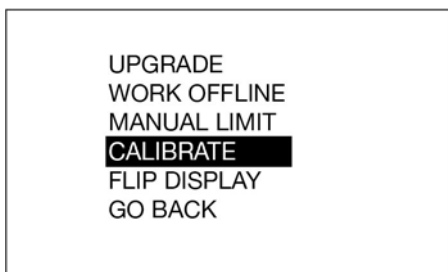

FIG. 24

- Use the LEFT or RIGHT ARROWS to select +/- and press the ENTER button.

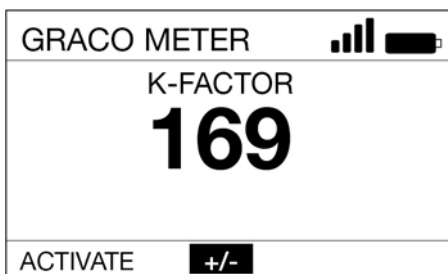

FIG. 25

8. Note the current K-FACTOR is displayed. In the example shown in FIG. 26 the K-FACTOR is 169.

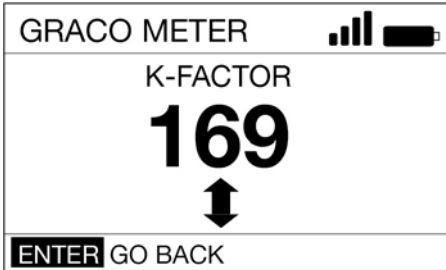

FIG. 26

9. Calculate the new K-Factor using the following equation:

$$K_{\text{new}} = \frac{(K_{\text{current}}) \times (\text{VOLUME DISPLAYED ON METER})}{(\text{VOLUME DISPENSED})}$$

Example:

$K_{\text{current}} = 169$

Volume displayed on metered dispense valve = 0.970 quart

Volume dispensed = 1 quart

$$K_{\text{new}} = \frac{(169) \times (0.970 \text{ quarts})}{(1.0 \text{ quarts})} = 163.9$$

Round to the nearest whole number: $163.9 = 164$.

NOTE: The unit of measurement for both volumes must be the same in the above equation.

10. Use the UP or DOWN ARROWS to adjust the K-FACTOR to the K-FACTOR (K_{new}) calculated in Step .

See **Table 1**, page 17 for recommended fluid calibration factors.

NOTE: Your calibration number may vary slightly due to temperature or rate of flow.

Table 1

Fluid	Calibration Factor
Oil (10W30)	173
Gear Lube	173
ATF	173
Antifreeze	150
Windshield Washer Solvent	150

11. Press the ENTER button to complete the calibration operation and save the new calibration factor.

Security Authorization

Utility Menu Code

Utility Menu Codes are setup by the System Administrator using the Pulse Fluid Management Software. Utility Menu Codes are assigned in the Device Settings Section of the Pulse Fluid Management Software.

Utility Menu Codes are used to access items in the meter utility menu. The System Administrator can setup a unique code for each meter or the same code can be used for all meters in the system.

PIN Codes

PIN Codes are setup by the System Administrator using the Pulse Fluid Management Software. PIN Codes are assigned in the User Section of the Pulse Fluid Management Software.

A PIN Code (Personal Identification Number) is a numeric password used to authenticate a user to the system. User access is granted only when the number entered at the metered dispense valve matches the number stored in the Pulse Software.

Set Up

To obtain dispense authorization the user is required to scan an NFC FOB or enter a 4-digit or 5-digit PIN Code **before every new dispense**.

Entering a PIN Code Number at the Metered Dispense Valve

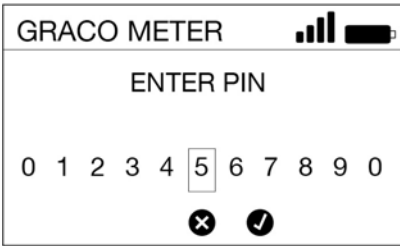

FIG. 27

To obtain authorization by entering a PIN Code number at the metered dispense valve:

1. Use the LEFT OR RIGHT ARROWS to select the first PIN Code number field.
2. Press the center ENTER button to select the number.
3. Continue this process until the complete, 4-digit or 5-digit PIN Code has been entered.
4. After the last number is entered, the cursor automatically moves over the "✓". Press center ENTER button to send the PIN Code entry to the Pulse Fluid Management Software.

The message VALIDATING as shown in FIG. 28, appears on the display.

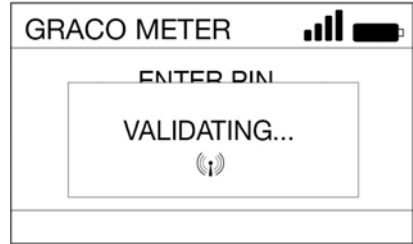

FIG. 28

If the Pulse Fluid Management Software recognizes the PIN Code and authorizes the dispense, a Dispense Screen displays.

If the Pulse Fluid Management Software does not recognize the PIN Code, the metered dispense valve will not be authorized for a dispense and the message INVALID displays.

Authorization Using an NFC FOB

Hold the NFC FOB over the metered dispense valve display to send the NFC Code to the Pulse Fluid Management Software for authorization (FIG. 29).

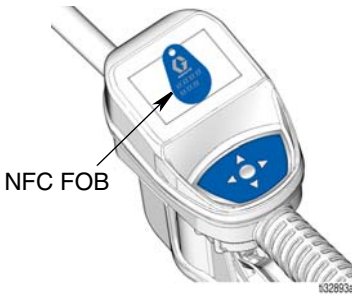

FIG. 29

The message VALIDATING (FIG. 28) appears on the display.

If the Pulse Fluid Management Software recognizes the NFC Code and authorizes the dispense a Dispense Screen displays.

If the Pulse Fluid Management Software does not recognize the NFC Code, the metered dispense valve will not be authorized for a dispense and the message INVALID displays.

NOTE: The NFC Code requires the NFC FOB be read in ten seconds. If the NFC Code is not read, the meter will default to the PIN Code entry screen.

Operation

Dispense Menu

Manual Dispense

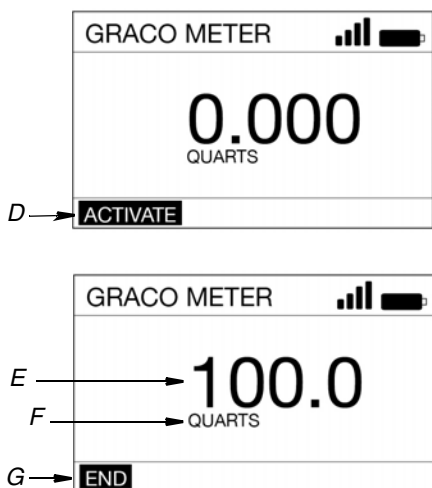

FIG. 30

- D** **ACTIVATE** - activates the trigger for dispense.
- E** **Volume of fluid dispensed** - as fluid is dispensed, this number increases to reflect the quantity of fluid that is dispensed.
- F** **Unit of measure, US or Metric.** This unit set using Pulse Fluid Management Software.
- G** **END** - finalizes the dispense in the Pulse system.

To dispense fluid in Manual Dispense mode:

1. Wake up metered dispense valve by pressing any button on the metered dispense valve key pad (FIG. 1, page 7).
2. Press ENTER button to select ACTIVATE (D).
3. Pull the trigger to dispense fluid. (The display (E) shows the amount dispensed.)

4. When the desired amount has been dispensed, release the trigger to stop the fluid flow.
5. END (G) is highlighted on the screen. Press the ENTER button to select END.

Preset Dispense

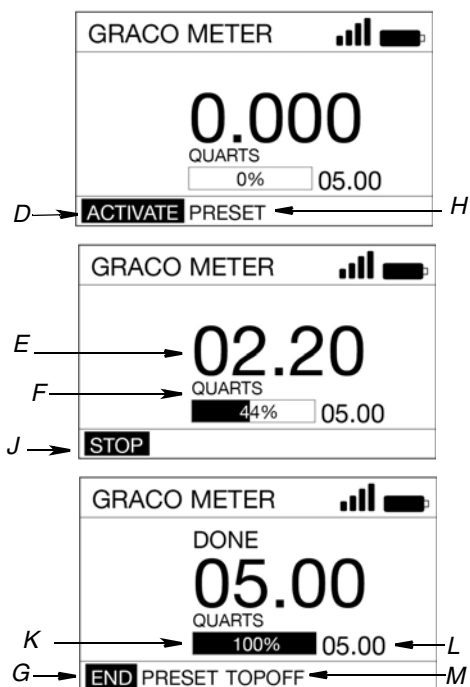

FIG. 31

- D** **ACTIVATE** - activates the trigger for dispense.
- E** **Volume of fluid dispensed** - as fluid is dispensed, this number increases to reflect the quantity of fluid that is dispensed.
- F** **Unit of measure, US or Metric.** This unit set using Pulse Fluid Management Software.
- G** **END** - finalizes the dispense in the Pulse system.

- H PRESET** - navigates to preset selection user menu. Allows user to select pre-defined preset valves.
- J STOP** - stops the preset dispense before reaching the preset amount. Deactivates the trigger.
- K Progress Bar** - visual display showing an estimate of how far through the dispense the task has progressed. Includes the complete value.
- L Total Preset Amount** - amount of fluid that will be dispensed when the preset is complete.
- M TOPOFF** - Allows the operator to dispense additional fluid after the preset amount has been reached.

To dispense fluid in Preset Dispense mode:

1. Wake up metered dispense valve by pressing any button on the metered dispense valve key pad (FIG. 1, page 7).
2. Enter PIN or Work Order (if required by metered dispense valve setup parameters).
3. Use the RIGHT ARROW to highlight PRESET (H) on the screen. Press The ENTER button to select PRESET(FIG. 32).

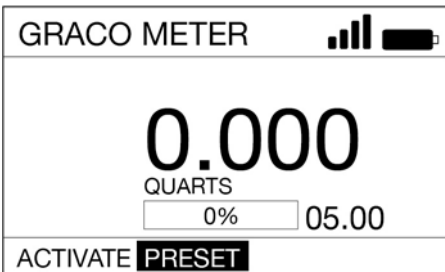

FIG. 32

4. Use the UP and DOWN ARROWS to toggle between the pre-set values. (A maximum of five presets can be defined using the Pulse Fluid Management Software.) When the desired pre-set value displays, press the ENTER button.
5. **ACTIVATE (D)** is highlighted on the screen. Press the ENTER button to select ACTIVATE.

6. Pull the trigger to dispense fluid. (The display (E) shows the amount dispensed.)

NOTE: If at any time before reaching the preset dispense amount, you want to change the preset value or stop the dispense, release the trigger to stop the fluid flow. Use the RIGHT or LEFT ARROW to select STOP (J). Press the ENTER button.

Changing Preset Before Dispense is Started

1. Highlight **ACTIVATE (D)** on the screen. Press the ENTER button.

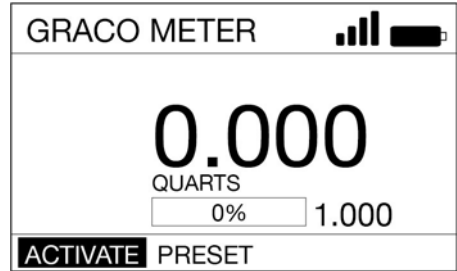

FIG. 33

2. Use the UP and DOWN ARROWS to change the preset value by increments of 0.1.
3. Pull the trigger to dispense fluid.

Operation

Changing Preset After the Dispense is Started

1. Perform Steps 1 - 5 of the Preset Dispense procedure.
2. Pull the trigger to dispense fluid until a quantity LESS than the preset amount is dispensed.
3. Use the RIGHT or LEFT ARROW to select STOP (*J*) (FIG. 34). Press the ENTER button.

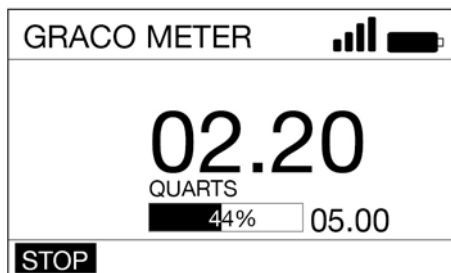

FIG. 34

4. Use the LEFT and RIGHT ARROWS to select PRESET (*H*). Press the ENTER button (FIG. 35).



FIG. 35

5. Press the UP and DOWN ARROWS to toggle between up to 5 presets that were entered using the Pulse Fluid Management Software.



FIG. 36

6. Press ENTER when the desired Preset value is displayed.
7. Use the RIGHT OR LEFT ARROW to ACTIVATE (*D*). Press the ENTER button.
8. Pull trigger to dispense fluid.

Completing the Dispense

1. When the preset amount has been dispensed, the metered dispense valve will stop dispensing.
 2. You now have the option to choose either:
 - TOPOFF (*M*) if you need to add additional fluid (See TOPOFF).
- NOTE:** The amount of TOPOFF allowed can be limited during metered dispense valve programming.
- OR . . .**
- END (*G*) to finish the dispense., press the ENTER button to select END.

TOPOFF

The TOPOFF feature allows the user to add additional fluid after the preset amount of fluid has been dispensed. Topoff amounts are programmed in the Pulse Fluid Management Software.

1. To TOPOFF (M), press the center ENTER button to select TOPOFF on the display.
2. Squeeze trigger to dispense additional fluid. The amount dispensed on the display will continue to count up.
3. The TOPOFF ends when the trigger is released or the maximum fluid allowed TOPOFF value is reached. The cursor will be over STOP on the display.

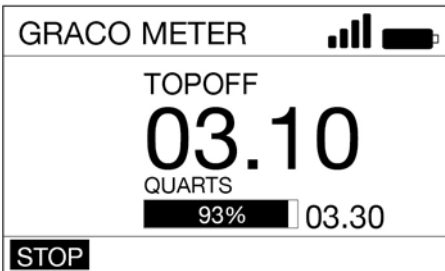

FIG. 37

4. Press the ENTER button.

Work Orders

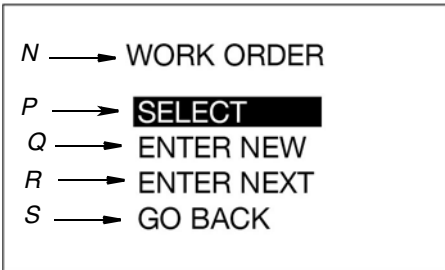

FIG. 38

- N WORK ORDER** - Title. Identifies the screen as the Work Order options screen (Appears on English language version only).
- P SELECT** - Displays work order options available when working with work orders created using Pulse Fluid Management Software.
- Q ENTER NEW** - Allows the operator to create a new work order on the metered dispense valve.
- R ENTER NEXT** - Displays the last work order in an EDITABLE format allowing the user to change part of all of the characters displayed to create a new work order.
- S GO BACK** - Displays the Main Menu Screen (see Fig. 13, page 14).

The System Administrator can program the metered dispense valve to process work orders using one or both of the following methods:

- Work Orders are created using the Pulse Fluid Management Software (**SELECT - P**).
- Work Orders are created by the user on the metered dispense valve (**ENTER NEW - Q or ENTER NEXT - R**).

Work Orders Created Using Pulse Fluid Management Software

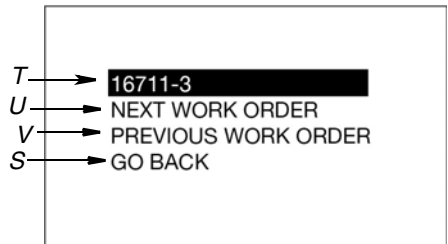

FIG. 39

- T Work Order Number** - Unique number assigned to a specific work order.
- U NEXT WORK ORDER** - Allows the operator to display the next work order entered in the queue.

Operation

- V **PREVIOUS WORK ORDER** - Allows the operator to display the previous work order entered in the queue.
- W **GO BACK** - Displays the Main Menu Screen (see Fig. 13, page 14).

3. When the complete work order number has been entered, select the "✓" (AA). Press the ENTER button.
4. The DISPENSE screen displays.

Work Orders Created On the Metered Dispense Valve

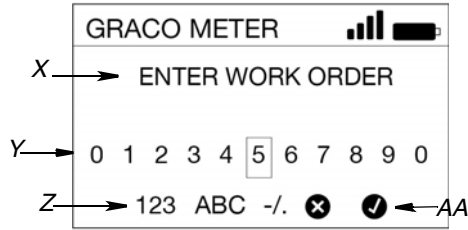

FIG. 40

- X **ENTER WORK ORDER** - Title. Identifies the screen as the Enter Work Order options screen.
- Y **NUMBERS/CHARACTERS** - Available numbers and character user can enter to create the unique work order identification number.
- Z **123 ABC -./** - Sets the character parameters used to create the unique work order identification number.
- AA **X/✓** - X cancels the work order before entering it in the system. ✓ accepts the work order and enters it into the system.

Work Orders can have a maximum of twenty characters.

To enter a new work order at the metered dispense valve:

1. Use the ARROWS to position the cursor over number or character you wish to select.
2. Press the ENTER button after each selection.

Setup Menus

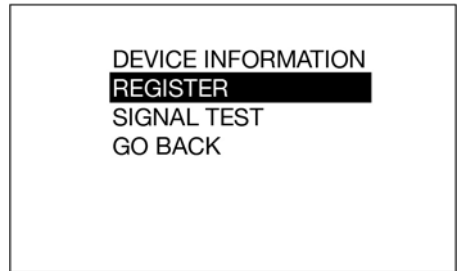

FIG. 41

DEVICE INFORMATION

The Device Information Screen is used for diagnostics only.

Device Information Screen

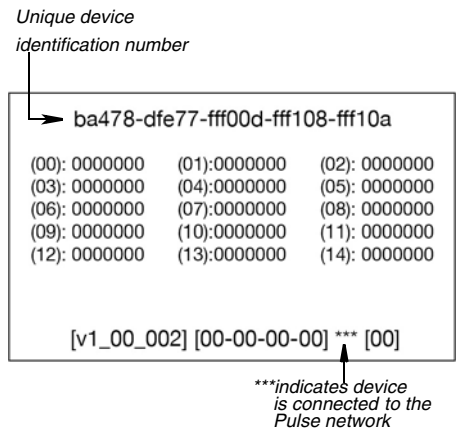

FIG. 42

REGISTER

See REGISTER in the Installation section of this manual, page 14.

SIGNAL TEST

A signal test can be performed to determine RF signal strength once the Pulse HUB is powered up, all extenders are registered to the HUB and the PAN network is established. The meter must be registered to the HUB before a signal test can be performed. Signal testing on a remote PAN network via the Remote Extender requires the meter be registered through the Remote Extender and not the Pulse HUB.

To perform the signal test:

1. From the main screen use the UP and DOWN ARROW on the navigation pad to select the SET-UP option.

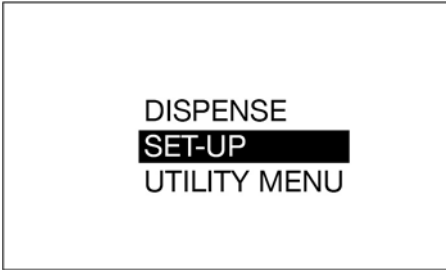

FIG. 43

2. Then select the SIGNAL TEST option.

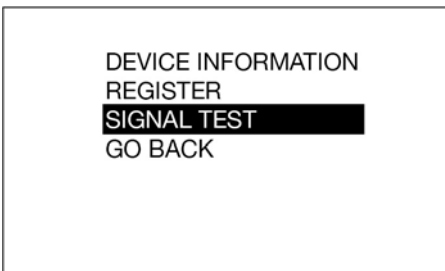

FIG. 44

3. To test the signal at a particular location use the navigation arrows to select and highlight ACTIVATE. Press the center select button.

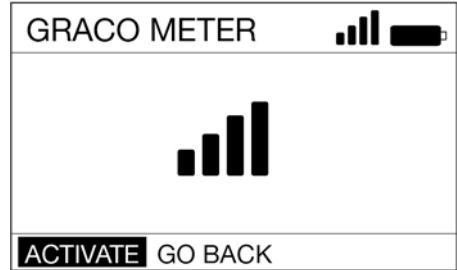

FIG. 45

- The meter must be kept in a stationary position during the signal test.
- The test will take approximately 10 secs.
- The output of the test will be a relative signal strength symbol or the message NO SIGNAL. For a robust network, every Pulse device should be at a 2 bar signal strength or better. Consider adding additional Extenders if a device location is only at 1 bar or below.
- There are several factors that affect and impact the RF signal strength at a given location such as, overhead garage doors opening and closing, vehicles on a lift and large vehicles in the RF pathway.
- Press the select button again to perform additional tests.

GO BACK

Returns to the Main Menu Screen, page 14.

Utility Menus

The Utility Menu is PIN or NFC Code protected. To activate the menu the Utility Menu Code must be entered.

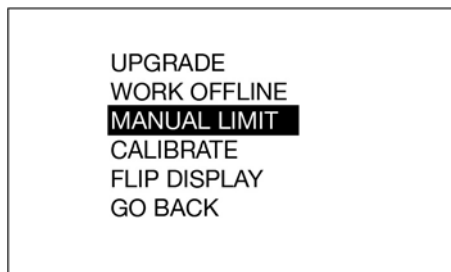

FIG. 46

UPGRADE

This feature is used to modify the firmware used by the metered dispense valve when a new and upgraded version of the firmware is released or a new feature is added. When this is required, your Graco distributor will contact you to arrange the upgrade. Your Graco Distributor will provide upgrade instructions.

WORK OFFLINE

In the event the communication link between the metered dispense valve and the Pulse HUB, the metered dispense valve will continue to function if it is placed in WORK OFFLINE Mode.

When communication with the Pulse HUB is re-established, the metered dispense valve will automatically change back to online operation.

When the metered dispense valve is put in Work Offline mode new work orders cannot be added at the metered dispense valve.

CALIBRATE

Calibrating the metered dispense valve assures you that dispenses are accurate. See **Calibrate the Metered Dispense Valve** instructions beginning on page 15.

MANUAL LIMIT

The maximum amount of fluid a user can dispense while the metered dispense valve is in MANUAL mode or WORK OFFLINE mode.

FLIP DISPLAY

Allows you to view data on the metered dispense valve display upside down for oil bar installation.

GO BACK

Returns to the Main Menu Screen, page 14.

Service

Battery Replacement

- Replace batteries with four AA, alkaline batteries.
- Be sure to follow the correct polarity as shown on the installation labels located on either side of the metered dispense valve when installing batteries in the battery compartment (FIG. 48).
- Do not mix different types of batteries together or old batteries with fresh ones. Always replace all 4 batteries with 4, fresh, new AA batteries.

To change the battery:

1. Remove screws (36) from the battery compartment cover (5).
2. Use a small, flat screwdriver to gently pry the cover away from the metered dispense valve housing on the bottom side of the cover, near the extension attachment as shown in FIG. 47.

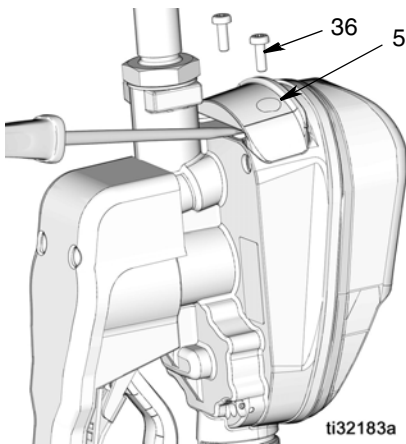

FIG. 47

3. Remove and separately recycle batteries according to all applicable regulations. Do not dispose of with household or commercial waste.

4. Install 4 new batteries. See labels on the each side of the housing and FIG. 48 for battery orientation.

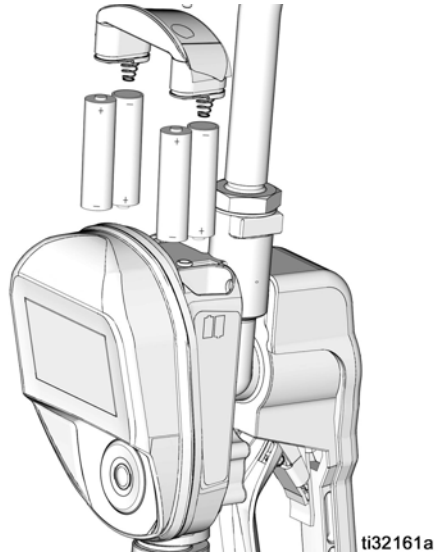

FIG. 48

5. Replace cover (5) and screws (36). Do not over-tighten screws (FIG. 49).

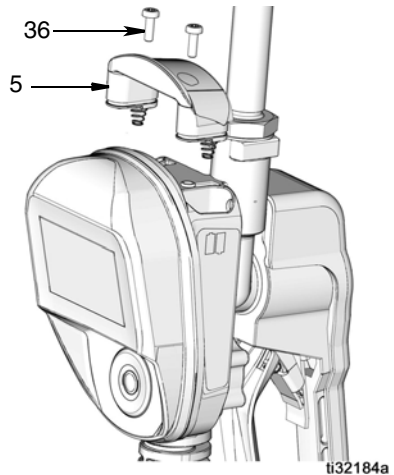

FIG. 49

Troubleshooting



Perform pressure relief procedure, page 10, before you check or repair the metered dispense valve. Be sure all other valves, controls and pump are operating properly.

Problem	Cause	Solution
Battery dead icon is present.	Batteries are low.	Replace batteries, page 27.
Display does not activate	Batteries are dead.	Replace batteries, page 27.
	Electronic control is malfunctioning.	Replace the electronic bezel assembly. Contact your Graco distributor for assistance ordering this part.
Slow or no fluid flow	Filter is clogged.	<ol style="list-style-type: none"> Relieve pressure, page 10. Clean or replace filter. If the problem remains, contact your Graco distributor for repair or replacement.
	Pump pressure is low.	Increase pump pressure.
	Twist lock nozzle not fully open.	Aim nozzle into bucket or rag. Fully open nozzle. <i>Do not trigger metered dispense valve when nozzle is closed!</i> If you do accidentally trigger the metered dispense valve with the nozzle closed, point nozzle into a waste bucket and open the nozzle to relieve pressure and expel built up fluid.
	Shut-off valve is not fully open.	Fully open shut-off valve.
	Foreign material is jammed in the metered dispense valve housing.	Contact your Graco distributor for repair or replacement.
Displayed dispensed amount is not accurate	Unit needs to be calibrated for the fluid that is being dispensed.	Calibrate the metered dispense valve for the fluid that is being dispensed.
Metered dispense valve leaks from cover/control	Poor seal at metering cover chamber	Contact your Graco distributor for repair or replacement.

Problem	Cause	Solution
<p>Metered dispense valve leaks from twist lock nozzle.</p> <p>It is important to distinguish between the two causes of this problem. A new nozzle will NOT correct a fluid leak caused by a faulty valve.</p>	Twist lock nozzle has a damaged seal.	Replace nozzle. See Installing Nozzle, page 13.
	Valve has damaged or obstructed seals.	Replace valve cartridge. Replacement Kit Part 25D904.
Metered dispense valve leaks from swivel	Poor swivel/hose connection.	Apply PTFE tape (leave a minimum 2 engaged threads uncovered for electrical continuity) or sealant to threads of hose and tighten the connection.
	Poor swivel/metered dispense valve housing connection.	Torque the fitting to 20-25 ft.-lb (27.12 - 34 N•m).
	Swivel seals have deteriorated and leak.	Replace swivel. Use Swivel Seal and Filter Replacement Kit 25D906. See Swivel Seal and Filter Replacement instructions page
Unit does not stop dispensing when assumed preset amount is dispensed.	Valve is dirty or seals are defective.	Replace valve cartridge. Replacement Kit Part 25D904.
	Low battery.	Replace batteries, page 27.
	Solenoid not functioning	Replace solenoid.
Weak or no RF signal	Changes/obstructions in RF pathway (.e., vehicle, overhead door)	Add Graco Extender to Pulse System. Order Graco Part No. 17F885 - US/Canada; 17F886 - EU; 17F887 - UK; 17F888 - ANZ.
Meter register fails	Poor RF signal	See Troubleshooting, Weak or no RF Signal
	Pulse Fluid Management software not in Discovery Mode	Set software to Discover Mode, then retry registration.
Screen locks up or freezes		Remove batteries. Wait 5 minutes, then replace batteries and restart.
Device is unable to register to the Pulse Pro network or device does not rejoin the network after system reboot.	Device is not meshing properly with the device network.	Flip the screen on the meter twice. See page 26. If this does not resolve the issue, toggle to Discovery mode on the HUB. Wait one minute and toggle it back.

Error Codes

Error codes are listed below. Even in an error condition the unit keeps track of the amount dispensed. Whenever an error code is displayed, you must end the dispense.

Error Code	Cause	Solution
Error 2	Reed Switch Error: Error occurred with pick-up in internal gear.	Ensure that your flow rate is not higher than 18 gpm (68 lpm). For further assistance, contact your Graco distributor.
	Reed switch malfunction.	Replace electronic bezel housing.
	Unit was dropped or unit encountered excessive vibration during shipping.	End dispense
	Air in fluid line.	Fix leaks in pump suction line.
	Excessive fluid pulsation.	Re-plumb pump suction line to a larger size.
Error 4	Flow has continued after it should have shut off.	End dispense
	Flow has occurred in lockout condition.	
Error 5	Manual limit reached on a dispense	Adjust manual limit higher if desired.
Error 6	Zero-value preset in attempted dispense	Internal error. Contact your Graco distributor.

Definition of Terms

Terms	Definition
CALIBRATE	UTILITY MENU option. Calibrating the metered dispense valve ensures dispenses are accurate.
DEVICE INFORMATION	UTILITY MENU option. Used by System Administrator for diagnostics and set up.
DISCOVERY MODE	Mode of Pulse Fluid Management software that allows new devices to be registered.
DISPENSE	(Depending on how the metered dispense valve is configured) Selecting DISPENSE displays either the DISPENSE Screen, PIN Entry Screen or WORK ORDER MENU Screen.
FLIP DISPLAY	UTILITY Menu option. Allows user to view data on the display upside down.
GO BACK	Returns the user to the previous screen.

Definition of Terms

Terms	Definition
HUB	The Pulse HUB is a self-contained computer with the Pulse Fluid Management Software preloaded. It also is the Personal Area Network (PAN) host used for RF communication with other Pulse system components (meters, Pump Air Control [PAC's], Tank Level Monitors [TLM's]). Access to the Pulse Fluid Management system is accomplished by http protocol (web browser on the Local Area Network [LAN]).
MANUAL DISPENSE	Amount of fluid dispensed is determined by the operator
MANUAL LIMIT	UTILITY MENU option. The maximum amount of fluid a user can dispense while the metered dispense valve is in MANUAL MODE or WORK OFFLINE MODE.
NFC CODE	Alpha-numeric code present on the NFC FOB. Used to authenticate a user to the system.
PIN CODE	A numeric password used to authenticate a user to the system.
PRESET DISPENSE	The metered dispense valve is programmed to dispense a default, preset volume. The preset volume can be modified on a work order to work order basis when sending work orders from the Pulse Fluid Management Software. The preset volume can be increased or decreased by an amount at the metered dispense valve prior to beginning the dispense.
REGISTER	Similar to pairing. Allows the Pulse HUB to identify and communicate with individual Pulse devices.
SET UP	List of metered dispense valve function related to initial system set up, device information, registration and signal testing.
SYSTEM ADMINISTRATOR	A user defined in the Pulse Fluid Management system software with full administrative authority.
TOPOFF	A percentage of the preset volume that can be (at the operator's discretion) dispensed after the preset amount has been reached.
UPGRADE	UTILITY MENU option. Modifies the firmware software used by the metered dispense valve when a new and upgraded version of the software is released or a new feature is added. When this is required, your Graco distributor will contact you to arrange the upgrade.
UTILITY MENU	List of metered dispense valve functions: UPGRADE, WORK OFFLINE, MANUAL LIMIT, CALIBRATE, FLIP DISPLAY, GO BACK.
UTILITY MENU CODE	Utility Menu Codes are used to access items in the meter utility menu. Can be a PIN or NFC Code.
WORK OFFLINE	UTILITY MENU option. If the communication link between the metered dispense valve and the Pulse Fluid Management Software is lost due to power loss or the computer crashing, the metered dispense valve will continue to function if it is placed in WORK OFFLINE Mode.
WORK ORDER	A unique (within the scope of the dealership) numeric or alphanumeric identifier that is linked to a list of labor and parts charges representing the expenses associated with a specific customer's vehicle repair. Also referred to as a repair order, or RO. The work order can be used more than once (it does not have to be unique).

Parts

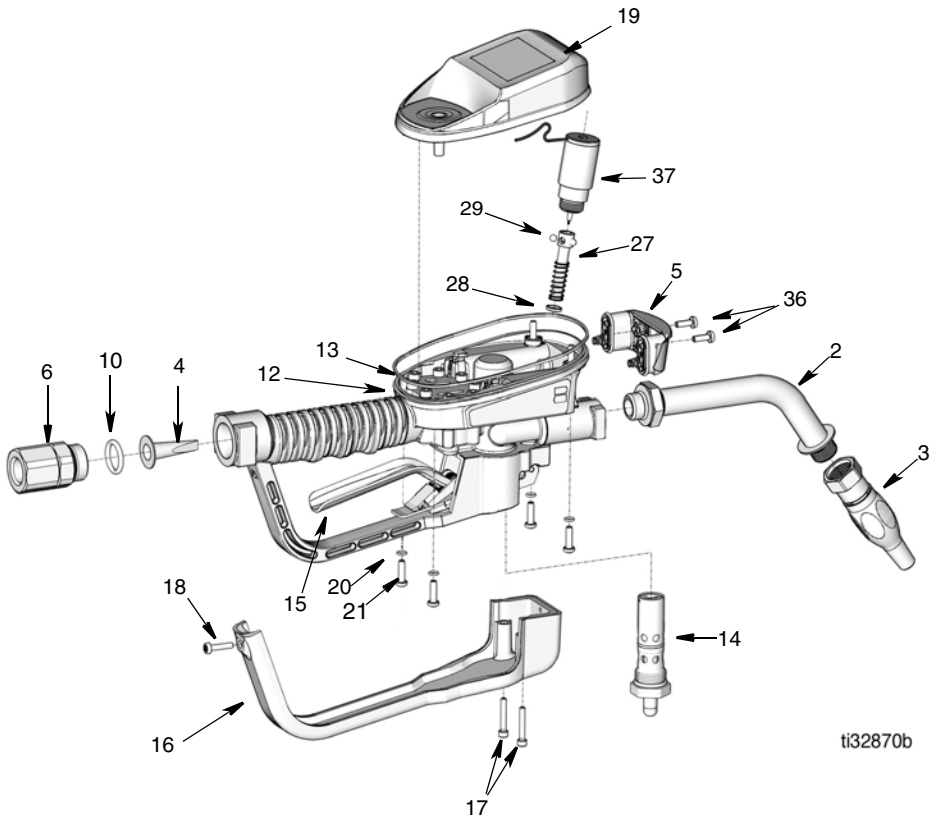

ti32870b

FIG. 50

Parts

Ref	Part	Description	Qty	Ref	Part	Description	Qty
1		VALVE, metered dispense valve (see models page 4)	1	15	25M601	TRIGGER, assy, all models except windshield washer solvent	1
2		EXTENSION			25M723	TRIGGER, assy, windshield washer solvent models only	1
	16Y863	<i>Flex</i>					
	255194	<i>Rigid</i>	1				
	255854	<i>Gear Lube</i>		16	129619	COVER, trigger guard	
	273079	<i>Windshield washer solvent</i>		17	16E337	SCREW, cap, sch, sst	2
3		NOZZLE		18	131256	SCREW, mach, torx pan hd	1
	17R220	<i>Automatic, quick close</i>	1	19	26C287	KIT, BEZEL, electrical	1
	17T207	<i>Manual Antifreeze</i>		20	131257	PACKING, o-ring	4
	255461	<i>High Flow</i>		21	25N342	SCREW, mach, torx pan hd	4
	255470	<i>Gear Lube/ATF</i>					
4★		STRAINER, mesh	1	27◆		ROD, trip	1
5 †	25M593	COVER, battery	1	28◆	129623	SEAL, molded	1
6		SWIVEL, straight		29◆		BALL, 5 mm	3
	247344	<i>1/2 in. NPT</i>	1	33	121413	BATTERY, pkg, 4 ct, alkaline AA (not shown)	1
	247345	<i>3/4 in. NPT</i>					
	24H097	<i>1/2 - 14 BSPT</i>		36 †	112380	SCREW, mach, pan hd	2
	24H098	<i>1/2 - 14 BSPP</i>		37	26C276	SOLENOID	1
	24H099	<i>3/4 - 14 BSPT</i>					
	24H100	<i>3/4 - 14 BSPP</i>					
10★	155332	PACKING, o-ring	1				
12		HOUSING, metered dispense valve	1				
13	131258	PACKING, square ring	1				
14	25D904	VALVE, metered dispense valve, assy	1				

Related Kits

Ref	Part	Description
◆	25D903	KIT, Trip Rod Repair, includes 27, 28, 29
★	25D906	KIT, Swivel Filter, includes 4 and 10
†	25D907	KIT, Battery Cover, includes 5 and 36

Technical Specifications

Technical Specifications

Metered Dispense Valve	US	Metric
Flow range*	0.25 to 18 gpm	0.9 to 68 lpm
<i>*Tested in 10W motor oil. Flow rates vary with fluid pressure, temperature and viscosity.</i>		
Maximum Working Pressure	1500 psi	103.4 bar
Units of Measure (factory set to quarts)	pints, quarts, gallons	liters
Weight	5.3 lb	2.4 kg
Dimensions (without extension)		
Length	13 in.	33 cm
Width	3.75 in.	9.5 cm
Height	5.75 in.	14.6 cm
Units of measure (factory set in quarts)	maximum recorded dispensed volume = 9999 units maximum preset volume = 9999 units	
Inlet	1/2-14 npt or 3/4-14 npt	
Outlet	3/4-16 straight thread o-ring boss	
Operating temperature range	4 °F to 158°F	-16°C to 70°C
Storage temperature range	-40°F to 158°F	-40°C to 70°C
Battery**	4AA alkaline batteries	
<i>**Recommended battery: Energizer® Alkaline E91.</i>		
RF Frequency Band	2400-2483.5 MHz	
Maximum RF Transmit Power	6.3 mW (8 dBm)	
NFC Frequency Band	13.56 MHz	
Maximum NFC Transmit Power	1 mW (0 dBm)	
Wetted parts	aluminum, stainless steel, PBT, nitrile rubber, zinc plated carbon steel, nickel plated carbon steel	
Fluid compatibility	antifreeze, gear oil, crankcase oil, ATF, windshield washer fluid*	
Metered Dispense Valve Accuracy†	+/- 0.5 percent	

† At 2.5 gpm (9.5 lpm), at 70°F (21°C), with 10-weight oil and 1 gallon dispensed. May require calibration.

* Windshield washer fluid contains mixtures of water, propylene glycol, ethylene glycol and up to 50% methanol or 50% ethanol. Contact Graco Technical Assistance for any other chemical(s) present in windshield washer fluid (WWS) or ensure the chemical is compatible with the wetted parts.

Graco 5-Year Meter and Valve Warranty

Graco 5-Year Meter and Valve Warranty

Graco warrants all equipment referenced in this document which is manufactured by Graco and bearing its name to be free from defects in material and workmanship on the date of sale to the original purchaser for use. With the exception of any special, extended, or limited warranty published by Graco, Graco will, for a period from the date of sale as defined in the table below, repair or replace equipment covered by this warranty and determined by Graco to be defective. This warranty applies only when the equipment is installed, operated and maintained in accordance with Graco's written recommendations.

Graco 5-Year Meter and Valve Extended Warranty	
Components	Warranty Period
Structural Components	5 years
Electronics	3 years
Wear Parts - including but not limited to o-rings, seals and valves	1 year

This warranty does not cover, and Graco shall not be liable for general wear and tear, or any malfunction, damage or wear caused by faulty installation, misapplication, abrasion, corrosion, inadequate or improper maintenance, negligence, accident, tampering, or substitution of non-Graco component parts. Nor shall Graco be liable for malfunction, damage or wear caused by the incompatibility of Graco equipment with structures, accessories, equipment or materials not supplied by Graco, or the improper design, manufacture, installation, operation or maintenance of structures, accessories, equipment or materials not supplied by Graco.

This warranty is conditioned upon the prepaid return of the equipment claimed to be defective to an authorized Graco distributor for verification of the claimed defect. If the claimed defect is verified, Graco will repair or replace free of charge any defective parts. The equipment will be returned to the original purchaser transportation prepaid. If inspection of the equipment does not disclose any defect in material or workmanship, repairs will be made at a reasonable charge, which charges may include the costs of parts, labor, and transportation.

THIS WARRANTY IS EXCLUSIVE, AND IS IN LIEU OF ANY OTHER WARRANTIES, EXPRESS OR IMPLIED, INCLUDING BUT NOT LIMITED TO WARRANTY OF MERCHANTABILITY OR WARRANTY OF FITNESS FOR A PARTICULAR PURPOSE.

Graco's sole obligation and buyer's sole remedy for any breach of warranty shall be as set forth above. The buyer agrees that no other remedy (including, but not limited to, incidental or consequential damages for lost profits, lost sales, injury to person or property, or any other incidental or consequential loss) shall be available. Any action for breach of warranty must be brought within one (1) year past the warranty period, or two (2) years for all other parts.

GRACO MAKES NO WARRANTY, AND DISCLAIMS ALL IMPLIED WARRANTIES OF MERCHANTABILITY AND FITNESS FOR A PARTICULAR PURPOSE, IN CONNECTION WITH ACCESSORIES, EQUIPMENT, MATERIALS OR COMPONENTS SOLD BUT NOT MANUFACTURED BY GRACO. These items sold, but not manufactured by Graco (such as electric motors, switches, hose, etc.), are subject to the warranty, if any, of their manufacturer. Graco will provide purchaser with reasonable assistance in making any claim for breach of these warranties.

In no event will Graco be liable for indirect, incidental, special or consequential damages resulting from Graco supplying equipment hereunder, or the furnishing, performance, or use of any products or other goods sold hereto, whether due to a breach of contract, breach of warranty, the negligence of Graco, or otherwise.

FOR GRACO CANADA CUSTOMERS

The Parties acknowledge that they have required that the present document, as well as all documents, notices and legal proceedings entered into, given or instituted pursuant hereto or relating directly or indirectly hereto, be drawn up in English. Les parties reconnaissent avoir convenu que la rédaction du présente document sera en Anglais, ainsi que tous documents, avis et procédures judiciaires exécutés, donnés ou intentés, à la suite de ou en rapport, directement ou indirectement, avec les procédures concernées.

Graco Information

For the latest information about Graco products, visit www.graco.com.

For patent information, see www.graco.com/patents.

TO PLACE AN ORDER, contact your Graco distributor or call to identify the nearest distributor.

Phone: 612-623-6928 or Toll Free: 1-800-533-9655, Fax: 612-378-3590

All written and visual data contained in this document reflects the latest product information available at the time of publication. Graco reserves the right to make changes at any time without notice.

Original instructions. This manual contains English. MM 3A5412

Graco Headquarters: Minneapolis

International Offices: Belgium, China, Japan, Korea

GRACO INC. AND SUBSIDIARIES • P.O. BOX 1441 • MINNEAPOLIS MN 55440-1441 • USA

Copyright 2018, Graco Inc. All Graco manufacturing locations are registered to ISO 9001.

www.graco.com, May 2019