

YWM-211P

**IGBT INVERTER MULTI-PROCESS WELDER (MIG,
PULSED MIG, SPOOL GUN COMPATIBLE MIG, STICK, LIFT TIG)**

Aug., 2023



OPERATOR'S MANUAL

YESWELDER®

Copyright © YesWelder

 To help us serve you better, go to www.yeswelder.com

Congratulations on your new YesWelder product! We at YesWelder create quality products at discounted prices to make welding affordable to everyone. To help us serve you better and for further questions, visit www.yeswelder.com. Thank you for your purchase.

TABLE OF CONTENTS

SAFETY	1-4
INSTALLATIONS	5
ACCESSORIES	6
DESCRIPTION	7-11
Controls And Settings.....	8-13
Installing The MIG Gun Assembly.....	11
Gas Cylinder And Regulator Connection.....	11
Installing The Welding Wire.....	11-13
OPERATION	13-25
Performance Data Plate And Duty Cycle.....	13-14
Welding Preparation.....	14
Welding Wire Selection.....	15
Gas Selection.....	15
Set up for MIG Welding (GMAW).....	15-23
Set up for Lift Arc TIG Welding (GTAW).....	23
Set up for Stick Welding (SMAW).....	24-25
MAINTENANCE & SERVICING	26
General Maintenance.....	26
Consumable Maintenance.....	26
TROUBLESHOOTING	27-32
OPERATION CODE	33
WIRING DIAGRAM	34

SAFETY

THANK YOU FOR SELECTING A QUALITY PRODUCT BY YESWELDER.

PLEASE EXAMINE THE PACKING BOX AND EQUIPMENT FOR DAMAGE IMMEDIATELY

When this equipment is shipped, the title passes to the purchaser upon receipt by the carrier. Consequently, claims for material damaged in shipment must be filed by the purchaser against the transportation company when the shipment is received.

SAFETY DEPENDS ON YOU

YESWELDER arc welding and cutting equipment are designed and built with safety. However, your overall safety can be increased by proper installation and thoughtful operation on your part. **DO NOT INSTALL, OPERATE OR REPAIR THIS EQUIPMENT WITHOUT READING THIS MANUAL AND THE SAFETY PRECAUTIONS CONTAINED THROUGHOUT.** And most importantly, think before you act and be careful.



WARNING

This statement appears where the information must be followed precisely to avoid serious personal injury or loss of life.



CAUTION

This statement appears where the information must be followed to avoid minor personal injury or damage to this equipment.



KEEP YOUR HEAD OUT OF THE FUMES.

DON'T get too close to the arc. Use corrective lenses if necessary to stay a reasonable distance from the arc.

READ and obey the Safety Data Sheet (SDS) and the warning label on all welding materials containers.

USE ENOUGH VENTILATION or exhaust at the arc, or both, to

keep the fumes and gases from your breathing zone and the general area.

IN A LARGE ROOM OR OUTDOORS, natural ventilation may be adequate if you keep your head out of the fumes (See below).

USE NATURAL DRAFTS or fans to keep the fumes away from your face.

If you develop unusual symptoms, see your supervisor. Perhaps the welding atmosphere and ventilation system should be checked.



WEAR CORRECT EYE, EAR & BODY PROTECTION

PROTECT your eyes and face with welding helmet properly fitted and with proper grade of filter plate (See ANSI Z49.1).

PROTECT your body from welding spatter and arc flash with protective clothing including woolen clothing, flame-proof apron and gloves, leather leggings, and high boots.

PROTECT others from spatter, flash, and glare with protective screens or barriers.

IN SOME AREAS, protection from noise may be appropriate.

BE SURE protective equipment is in good condition. Also, wear safety glasses in work area **AT ALL TIMES.**



SPECIAL SITUATIONS

DO NOT WELD OR CUT containers or materials which previously had been in contact with hazardous substances unless they are properly cleaned.

DO NOT WELD OR CUT painted or plated parts unless special precautions with ventilation have been taken. They can release highly toxic fumes or gases.

Additional precautionary measures:

PROTECT compressed gas cylinders from excessive heat, mechanical shocks, and arcs; fasten cylinders so they cannot fall. **BE SURE** cylinders are never grounded or part of an electrical circuit.

REMOVE all potential fire hazards from welding area.

ALWAYS HAVE FIRE FIGHTING EQUIPMENT READY FOR IMMEDIATE USE AND KNOW HOW TO USE IT.

SAFETY



WARNINGS



CALIFORNIA PROPOSITION 65 WARNINGS



WARNING: Breathing diesel engine exhaust exposes you to chemicals known to the State of California to cause cancer and birth defects, or

other reproductive harm.

- Always start and operate the engine in a well-ventilated area.
- If in an exposed area, vent the exhaust to the outside.
- Do not modify or tamper with the exhaust system.
- Do not idle the engine except as necessary.

For more information go to

www.P65warnings.ca.gov/diesel

WARNING: This product, when used for welding or cutting, produces fumes or gases which contain chemicals known to the State of California to cause birth defects and, in some cases, cancer. (California Health & Safety Code § 25249.5 et seq.)



WARNING: Cancer and Reproductive Harm
www.P65warnings.ca.gov

ARC WELDING CAN BE HAZARDOUS. PROTECT YOURSELF AND OTHERS FROM POSSIBLE SERIOUS INJURY OR DEATH. KEEP CHILDREN AWAY. PACEMAKER WEARERS SHOULD CONSULT WITH THEIR DOCTOR BEFORE OPERATING.

Read and understand the following safety highlights. For additional safety information, it is strongly recommended you download free PDF of Standard ANSI Z49.1 from the American Welding Society.

<https://www.aws.org/library/doclib/AWS-Z49-2021.pdf>

BE SURE THAT ALL INSTALLATION, OPERATION, MAINTENANCE AND REPAIR PROCEDURES ARE PERFORMED ONLY BY QUALIFIED INDIVIDUALS.



FOR ENGINE POWERED EQUIPMENT.

- 1.a. Turn the engine off before troubleshooting and maintenance work unless the maintenance work requires it to be running.



- 1.b. Operate engines in open, well-ventilated areas or vent the engine exhaust fumes outdoors.



- 1.c. Do not add the fuel near an open flame welding arc or when the engine is running. Stop the engine and allow it to cool before refueling to prevent spilled fuel from vaporizing on contact with hot engine parts and igniting. Do not spill fuel when filling tank.

If fuel is spilled, wipe it up and do not start engine until fumes have been eliminated.

- 1.d. Keep all equipment safety guards, covers and devices in position and in good repair. Keep hands, hair, clothing and tools away from V-belts, gears, fans and all other moving parts when starting, operating or repairing equipment.



- 1.e. In some cases it may be necessary to remove safety guards to perform required maintenance. Remove guards only when necessary and replace them when the maintenance requiring their removal is complete. Always use the greatest care when working near moving parts.

- 1.f. Do not put your hands near the engine fan. Do not attempt to override the governor or idler by pushing on the throttle control rods while the engine is running.

- 1.g. To prevent accidentally starting gasoline engines while turning the engine or welding generator during maintenance work, disconnect the spark plug wires, distributor cap or magneto wire as appropriate.

- 1.h. To avoid scalding, do not remove the radiator pressure cap when the engine is hot.



ELECTRIC AND MAGNETIC FIELDS MAY BE DANGEROUS



- 2.a. Electric current flowing through any conductor causes localized Electric and Magnetic Fields (EMF). Welding current creates EMF fields around welding cables and welding machines

- 2.b. EMF fields may interfere with some pacemakers, and welders having a pacemaker should consult their physician before welding.

- 2.c. Exposure to EMF fields in welding may have other health effects which are now not known.

- 2.d. All welders should use the following procedures in order to minimize exposure to EMF fields from the welding circuit:

- 2.d.1. Route the electrode and work cables together - Secure them with tape when possible.

- 2.d.2. Never coil the electrode lead around your body.

- 2.d.3. Do not place your body between the electrode and workcables. If the electrode cable is on your right side, the work cable should also be on your right side.

- 2.d.4. Connect the work cable to the workpiece as close as possible to the area being welded.

- 2.d.5. Do not work next to welding power source.

SAFETY



ELECTRIC SHOCK CAN KILL.



- 3.a. The electrode and work (or ground) circuits are electrically “hot” when the welder is on. Do not touch these “hot” parts with your bare skin or wet clothing.
- Wear dry, hole-free gloves to insulate hands.
- 3.b. Insulate yourself from work and ground using dry insulation. Make certain the insulation is large enough to cover your full area of physical contact with work and ground.
- In addition to the normal safety precautions, if welding must be performed under electrically hazardous conditions (in damp locations or while wearing wet clothing; on metal structures such as floors, gratings or scaffolds; when in cramped positions such as sitting, kneeling or lying, if there is a high risk of unavoidable or accidental contact with the workpiece or ground) use the following equipment:**
- Semiautomatic DC Constant Voltage (Wire) Welder.
 - DC Manual (Stick) Welder.
 - AC Welder with Reduced Voltage Control.
- 3.c. In semiautomatic or automatic wire welding, the electrode, electrode reel, welding head, nozzle or semiautomatic welding gun are also electrically “hot”.
- 3.d. Always be sure the work cable makes a good electrical connection with the metal being welded. The connection should be as close as possible to the area being welded.
- 3.e. Ground the work or metal to be welded to a good electrical (earth) ground.
- 3.f. Maintain the electrode stinger, work clamp, welding cable and welding machine in good, safe operating condition. Replace damaged insulation.
- 3.g. Never dip the electrode in water for cooling.
- 3.h. Never simultaneously touch electrically “hot” parts of electrode stingers connected to two welders because voltage between the two can be the total of the open circuit voltage of both welders.
- 3.i. When working above floor level, use a safety belt to protect yourself from a fall should you get a shock.
- 3.j. Also see Items 6.c. and 8.



ARC RAYS CAN BURN.



- 4.a. Use a shield with the proper filter and cover plates to protect your eyes from sparks and the rays of the arc when welding or observing open arc welding. Welding shield and filter lens should conform to ANSI Z87.1 standards.
- 4.b. Use suitable clothing made from durable flame-resistant material to protect your skin and that of your helpers from the arc rays.
- 4.c. Protect other nearby personnel with suitable, non-flammable screening and/or warn them not to watch the arc nor expose themselves to the arc rays or to hot spatter or metal.



FUMES AND GASES CAN BE DANGEROUS.



- 5.a. Welding may produce fumes and gases hazardous to health. Avoid breathing these fumes and gases. When welding,
- keep your head out of the fume. Use enough ventilation and/or exhaust at the arc to keep fumes and gases away from the breathing zone. **When welding hardfacing (see instructions on container or SDS) or on lead or cadmium plated steel and other metals or coatings which produce highly toxic fumes, keep exposure as low as possible and within applicable OSHA PEL and ACGIH TLV limits using local exhaust or mechanical ventilation unless exposure assessments indicate otherwise. In confined spaces or in some circumstances, outdoors, a respirator may also be required. Additional precautions are also required when welding on galvanized steel.**
- 5.b. The operation of welding fume control equipment is affected by various factors including proper use and positioning of the equipment, maintenance of the equipment and the specific welding procedure and application involved. Worker exposure level should be checked upon installation and periodically thereafter to be certain it is within applicable OSHA PEL and ACGIH TLV limits.
- 5.c. Do not weld in locations near chlorinated hydrocarbon vapors coming from degreasing, cleaning or spraying operations. The heat and rays of the arc can react with solvent vapors to form phosgene, a highly toxic gas, and other irritating products.
- 5.d. Shielding gases used for arc welding can displace air and cause injury or death. Always use enough ventilation, especially in confined areas, to insure breathing air is safe.
- 5.e. Read and understand the manufacturer's instructions for this equipment and the consumables to be used, including the Safety Data Sheet (SDS) and follow your employer's safety practices. SDS forms are available from your welding distributor or from the manufacturer.
- 5.f. Also see item 1.b.

SAFETY



WELDING AND CUTTING SPARKS CAN CAUSE FIRE OR EXPLOSION.



- 6.a. Remove fire hazards from the welding area. If this is not possible, cover them to prevent the welding sparks from starting a fire. Remember that welding sparks and hot materials from welding can easily go through small cracks and openings to adjacent areas. Avoid welding near hydraulic lines. Have a fire extinguisher readily available.
- 6.b. Where compressed gases are to be used at the job site, special precautions should be used to prevent hazardous situations. Refer to "Safety in Welding and Cutting" (ANSI Standard Z49.1) and the operating information for the equipment being used.
- 6.c. When not welding, make certain no part of the electrode circuit is touching the work or ground. Accidental contact can cause overheating and create a fire hazard.
- 6.d. Do not heat, cut or weld tanks, drums or containers until the proper steps have been taken to insure that such procedures will not cause flammable or toxic vapors from substances inside. They can cause an explosion even though they have been "cleaned". For information, purchase "Recommended Safe Practices for the Preparation for Welding and Cutting of Containers and Piping That Have Held Hazardous Substances", AWS F4.1 from the American Welding Society (see address above).
- 6.e. Vent hollow castings or containers before heating, cutting or welding. They may explode.
- 6.f. Sparks and spatter are thrown from the welding arc. Wear oil free protective garments such as leather gloves, heavy shirt, cuffless trousers, high shoes and a cap over your hair. Wear ear plugs when welding out of position or in confined places. Always wear safety glasses with side shields when in a welding area.
- 6.g. Connect the work cable to the work as close to the welding area as practical. Work cables connected to the building framework or other locations away from the welding area increase the possibility of the welding current passing through lifting chains, crane cables or other alternate circuits. This can create fire hazards or overheat lifting chains or cables until they fail.
- 6.h. Also see item 1.c.
- 6.i. Read and follow NFPA 51B "Standard for Fire Prevention During Welding, Cutting and Other Hot Work", available from NFPA, 1 Batterymarch Park, PO box 9101, Quincy, MA 02269-9101.
- 6.j. Do not use a welding power source for pipe thawing.



CYLINDER MAY EXPLODE IF DAMAGED.

- 7.a. Use only compressed gas cylinders containing the correct shielding gas for the process used and properly operating regulators designed for the gas and pressure used. All hoses, fittings, etc. should be suitable for the application and maintained in good condition.
- 7.b. Always keep cylinders in an upright position securely chained to an undercarriage or fixed support.
- 7.c. Cylinders should be located:
 - Away from areas where they may be struck or subjected to physical damage.
 - A safe distance from arc welding or cutting operations and any other source of heat, sparks, or flame.
- 7.d. Never allow the electrode, electrode stinger or any other electrically "hot" parts to touch a cylinder.
- 7.e. Keep your head and face away from the cylinder valve outlet when opening the cylinder valve.
- 7.f. Valve protection caps should always be in place and hand tight except when the cylinder is in use or connected for use.
- 7.g. Read and follow the instructions on compressed gas cylinders, associated equipment, and CGA publication P-1, "Precautions for Safe Handling of Compressed Gases in Cylinders," available from the Compressed Gas Association, 14501 George Carter Way Chantilly, VA 20151.



FOR ELECTRICALLY POWERED EQUIPMENT.



- 8.a. Turn off the power using the disconnect switch at the fuse box before working on the equipment.
- 8.b. Install equipment in accordance with the U.S. National Electrical Code, all local codes and the manufacturer's recommendations.
- 8.c. Ground the equipment following the U.S. National Electrical Code and the manufacturer's recommendations.

INSTALLATION

TECHNICAL SPECIFICATIONS: YWM-211P

INPUT-SINGLE PHASE ONLY				
Standard Voltage/Frequency		Input Current		
220V±10% 50/60Hz		I _{1 max} =34A, I _{1 eff} =26.3A		
110V±10% 50/60Hz		I _{1 max} =50A, I _{1 eff} =38.7A		
RATED OUTPUT-DC ONLY				
Voltage	Mode	Duty Cycle	Current	Volts at Rated Current
220V	GMAW	60%	200A	24V
		100%	158A	21.9V
	SMAW	60%	180A	27.2V
		100%	139A	25.5V
	GTAW	60%	200A	18V
		100%	155A	16.2V
110V	GMAW	60%	160A	22V
		100%	123A	20.1V
	SMAW	60%	145A	25.8V
		100%	112A	24.5V
	GTAW	60%	160A	16.4V
		100%	124A	15V
OUTPUT RANGE				
Voltage	Mode	Open Circuit Voltage	Welding Current Range	Welding Voltage Range
220V	GMAW	72V	30A~200A	15.5V~24V
	SMAW		20A~180A	20.8V~27.2V
	GTAW		10A~200A	10.4V~18V
110V	GMAW		30A~160A	15.5V~22V
	SMAW		20A~145A	20.8V~25.8V
	GTAW		10A~160A	10.4V~16.4V
OTHER PARAMETERS				
Machine	Power Factor	Efficiency	Protection Class	Insulation Class
YWM-211P	0.8	≥80%	IP21S	F
PACKING DIMENSIONS				
Machine	Length	Width	Height	Weight
YWM-211P	540mm	360mm	445mm	17.95Kg
TEMPERATURE RANGE				
Operating Temperature Range		Storage Temperature Range		
-20°C ~ +50°C(-4°F~122°F)		-20°C ~ +50°C(-4°F~122°F)		

Read the entire installation section before you start the installation.

INSTALLATION

WARNIG

ELECTRIC SHOCK can kill.

- Only qualified personnel should perform this installation.
- Only personnel reading and understanding the YWM-211P Operator's Manual should install and operate this equipment.



- The machine must be plugged into a grounded receptacle per national, local, or other applicable electrical codes.
- The YWM-211P power switch should be in the OFF("O") position when installing the work cable and gun and connecting the power cord to input power.

SELECT SUITABLE LOCATION

Locate the YWM-211P in a dry place with free clean air circulation to minimize the chance of dirt accumulation that can block air passages and cause overheating.

STACKING

YWM-211P cannot be stacked.

TILTING

The machine should be placed on a secure, level surface or a recommended cart. The equipment may topple over if this requirement is not followed.

ACCESSORIES

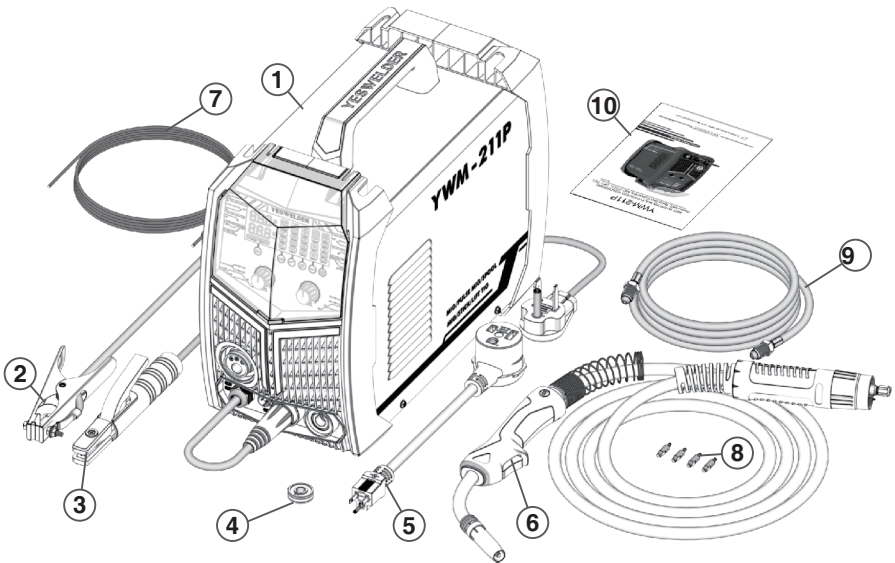

1. Welder

2. Work Clamp

3. Electrode Holder

4. V Knurl Groove

Drive Roller: .023"/.0

30" (.030" & .035" on

the machine)

5. 220V~110V Power Plug

6. 24KD MIG Gun

7. Graphene Feeding Liner

8. Contact Tips (4pieces)

9. Gas Hose

10. Operator's Manual

DESCRIPTION

SAFETY PRECAUTIONS

Read entire operation section before operating the WIRE FEEDER WELDER.

WARNING

ELECTRIC SHOCK can kill.

- Do not touch electrically live parts such as output terminals or internal wiring.
- Insulate yourself from the work and ground.
- Always wear dry insulating gloves.



FUMES AND GASES can be dangerous.

- Keep your head out of fumes.
- Use ventilation or exhaust to remove fumes from breathing zone.



WELDING SPARKS can cause fire or explosion

- Keep flammable material away.
- Do not weld on closed containers.



ARC RAYS can burn eyes and skin.

- Wear eye, ear and body protection.



Observe all safety information throughout this manual.

PRODUCT DESCRIPTION (PRODUCT CAPABILITIES)

This small portable wire feed welder is capable of MIG (GMAW) on steel, mild steel, stainless steel. The wire feed welder is also capable of STICK welding (SMAW) and DC lift TIG welding (GTAW).

MIG welding stands for Metal Inert Gas welding and requires a shielding gas to protect the weld until it cools. Appropriate shielding gas based on the type of material you are welding can be purchased separately from your local welding gas distributor. MIG welding is ideal for welding on thinner and clean materials when a very clean excellent cosmetic looking weld is required. An example would be automotive body panels.

This machine does not have a built in Gas Solenoid so a one piece gas valve TIG Torch is required, The gas valve must be opened manually before welding and closed manually when welding is completed. The arc is activated using a lift arc technique.

COMMON WELDING ABBREVIATIONS

GMAW (MIG/MAG)

Gas Metal Arc Welding

SMAW

Shielded Metal Arc Welding (Stick)

GTAW(TIG)

Gas Tungsten Arc Welding

Controls And Settings

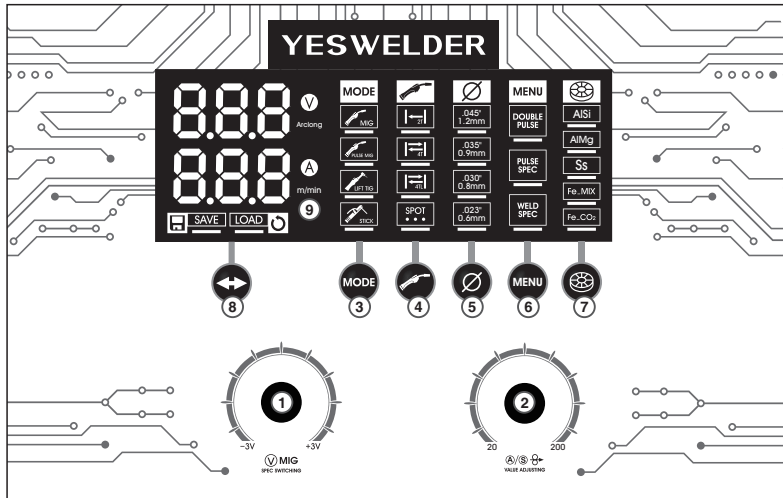

1. Function / Voltage Adjustment / Gas Checking Knob: Permits selecting Gas Pre-Flow, Post-Flow, Inductance, Rin, Hot start, Burn back time, Spot time in MIG and Pulsed MIG Mode, Synergy or Manual MIG in MIG Mode, Pulse / Double-Pulse Pulsed MIG Mode, IBS, FRQ, Duty cycle in Double-Pulse MIG Mode, Arc force, Hot start, VRD, and Anti-stick in Stick Mode. Permits selecting output voltage (fine-adjusting voltage in synergic mode).

Press the button, the gas checking function will be on.

2. Value Adjustment / WFS Knob: Permits selecting output current, wire feeding speed (manual MIG mode), on/off for double pulse, on/off for synergic MIG, choosing different values for weld specifications.

Press and hold the button for three seconds or more to turn on the wire-feed-inching function and feed the wire through the gun as assembly.

3. Process Selection Button: Allows the user to toggle between processes MIG/MAG (GMAW) / Pulsed MIG / STICK(SMAW) / Lift TIG (GTAW).

4. 2T/4T/4TL/ Spot Torch Operation Selector Button.

5. Wire Diameter Selector Button: .023"/.030"/.035"/.045".

6. Menu Button: Press to toggle between Pulse and Double Pulse; Enter Welding Spec for specific settings such as Gas Pre-flow and Post-flow, Inductance, Rin, hot start current, burn back time, spot time DIG (Arc force), hot start, anti-stick; Enter Pulse Spec such as IBS, FRQ (frequency), or duty cycle.

7. Material Selector: Al-Si / Al-Mg / SS / Fe Mix / Fe CO₂

8. Setting Saving and Loading Button.

9. Color LED Screen: Display the details of a welding procedure such as welding material, process mode, wire diameter, output voltage, output current, wire feeding speed current, and other welding parameters.

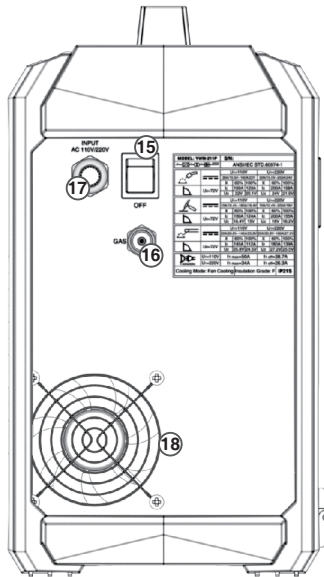
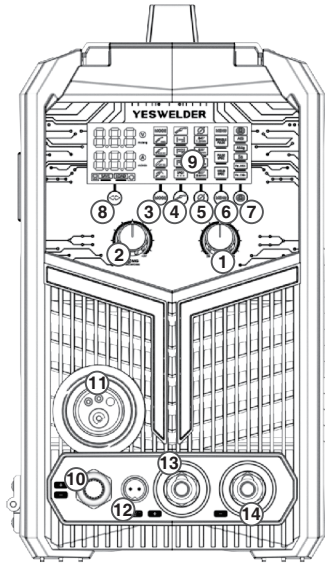

10. Wire Drive Polarity Lead-Permits configuring the wire drive to positive or negative polarity by inserting it into the positive or negative receptacle. Ensure the connector is locked into place tightly by turning clockwise.
11. Gun Connection (Euro Connect)-Permits attachment of a MIG welding gun. Ensure the gun is fully seated into the brass receptacle.
12. Spool Gun Trigger Connector Receptacle-Permits triggering the machine for aluminum MIG. Connect the 2-pin connector present on the welding gun to the receptacle.
13. Positive Output Receptacle-Permits attaching a work lead, electrode holder or the wire drive polarity lead to DC positive. Turn clockwise to lock it into place.
14. Negative Output Receptacle: Permits attaching a work lead, electrode holder, or the wire drive polarity lead to DC negative. Turn clockwise to lock it into place.
15. Power Switch: Turns the power on and off to the machine.
16. Gas Inlet: Shielding gas connects to this inlet (gas fitting is 5/8"-18 RH).
17. Input Power Cable.
18. Fan.

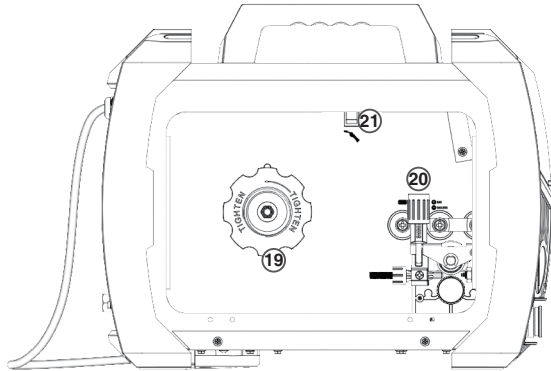

19. Wire Spool Spindle and Brake: Holds a 4-inch diameter spool. Use the 2-inch ID spindle adapter included with the machine to run an 8-inch diameter spool. The user can set the brake's friction load through the Wing Nut to prevent the spool from over-rotating when the trigger is released.
20. Wire Feeder & Components: Feeds the welding wire from the wire spool through the welding gun to the welding pool.
21. Spool Gun/Standard Torch Switch: Pre-installed switch permits either standard MIG gun welding or spool gun welding with additional YesWelder LBT 150. Other branded guns with European connection will be compatible, spool gun should come with a 2-pin switch as well.

Installing The MIG Gun Assembly

- Attach the standard MIG welding gun to the EURO CONNECT on the front of the welder. Ensure the gun connector end is seated fully into the wire drive and tighten the thumbscrew to secure the gun.

Gas Cylinder And Regulator Connection

The gas cylinder (not supplied) should be located near the rear of the welder, in a well-ventilated area and securely fixed to the work bench or to the wall to ensure that it will not fall.

For safety and economy, ensure that the regulator is fully closed (turned counter-clockwise) when not welding and when fitting or removing the gas cylinder.

- Turn the regulator adjustment knob counter-clockwise to ensure the valve is fully closed.
- Screw the gas regulator down on the gas bottle valve and tighten.
- Connect the gas hose to the regulator, securing with the clip/nut provided.
- Connect the other end to the GAS Inlet (16) on the back of the machine.
- Open the cylinder valve, then set the gas flow to approximately 20-30 CFH (cubic ft. per hour) on the regulator.
- For MIG welding: Pull the gun trigger to ensure the shielding gas flows through the gun.



WARNING: Cylinders are highly pressurized. Handle with care. Serious accidents can result from improper handling or misuse of compressed gas cylinders. Please do not drop the cylinder, knock it over, and expose it to excessive heat, flames, or sparks. Do not strike it against other cylinders or strike an arc on it.

Installing The Welding Wire



ENSURE GAS AND ELECTRICAL SUPPLIES ARE DISCONNECTED. Before proceeding, remove the nozzle and the contact tip from the gun.



WARNING: ELECTRIC SHOCK CAN KILL! Always turn the Power SWITCH OFF and unplug the welder's **INPUT POWER CABLE** from the AC power source before installing wire. When the gun trigger is depressed, the drive rolls, spool of wire, wire being fed, and electrode are all electrically live (hot).

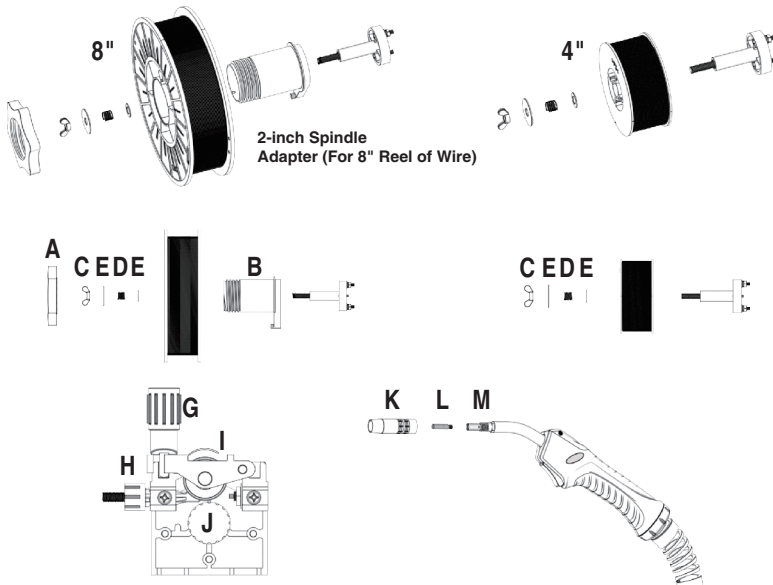

Installing 4-Inch Spool (See Figure For Part Identification):

- Open the access panel.
- Unscrew and remove the wire spool retention cap used for 8-inch spools (A) and store it someplace safe.
- Remove the spindle adapter for 8-inch spools (B) and keep it someplace safe.
- Remove the nut (C), spring (D), and washers (E).
- Remove the outer wrapping from the included spool of wire and then find the leading end of the wire (it goes through a hole in the outer edge of the spool and is bent over the spool edge to prevent the wire from unspooling) but do not unhook it yet.
- Place the spool on the WIRE SPOOL SPINDLE so that the wire unspools from the bottom, and the spool will rotate counterclockwise.
- Place the washer, wire spool, bushing, spring, and nut back.
- Proceed to the "FEEDING WIRE THROUGH THE MIG GUN" instructions below.

Installing 8-Inch Spool (See Figure For Part Identification):

- Open the access panel.
- Unscrew and remove the wire spool retention cap (A).
Note: If the wire spool retention cap and the spindle adapter for 8-inch spools (B) are not present (the machine was last used with a 4-inch spool), put the spindle adapter for 8-inch spools back in place.
- Ensure all of the components used for a 4-inch spool are still in place. They are necessary for 8-inch spools as well (nut (C), spring (D), and washers (E)).
- Remove the outer wrapping from the spool of wire and then find the leading end of the wire (it goes through a hole in the outer edge of the spool and is bent over the spool edge to prevent the wire from unspooling) but do not unhook it yet.
- Place the spool on the spindle adapter for an 8-inch spool so that the wire unspools from the bottom, and the spool will rotate counterclockwise.
Note: Be sure the alignment pin near the base of the spindle adapter for 8-inch spools is inserted in the corresponding hole on the spool.
- Thread the wire spool retention cap back in place.

Feeding Wire Through The Mig Gun:

- Unhook the wire and hold the wire end and the spool in one hand. Use the other hand to tighten the nut (C) to some extent so that when the spool is released, it does not spin freely and uncoils the wire. Tightening the nut too much may cause inconsistent wire feeding. Leaving it too loose will allow the wire to straighten freely from the spool, leaving a mess of wire in the cabinet.
- While holding the wire in place, use a wire cutter to cut the bent end of the wire so that only a straight end remains.
- Hold the wire end in one hand and release the drive roller pressure arm (I) by pulling the pressure arm adjustment knob (G) toward you. Hold the drive roller pressure arm up off of the drive roller and insert the leading end of the wire into the inlet guide tube (H). Push the wire across the drive roller (J) and into the gun assembly approximately six inches.
- Align the wire up in the inner groove of the drive roller and allow the drive pressure arm to drop onto the drive roller. Pull the pressure arm adjustment knob back over the pressure arm and tighten (turn clockwise) the pressure adjusting knob until the pressure roller applies enough force on the wire to prevent it from slipping out of the drive assembly.
NOTE: Too much pressure will cause wire to feeding problems and may burn out the wire feed motor.
- Let go of the wire.
- Remove the nozzle (K) and contact tip (L) from the end of the gun assembly (M).
- Plug the welder's INPUT POWER CABLE into the AC power source. Adjust the settings at the front panel per the setup chart on the welding machine's inside door according to the wire and workpiece size.
- Pull the trigger on the MIG gun to feed the wire through the gun assembly. Check if the drive roller is slipping on the wire and increase pressure on the pressure arm adjustment knob if necessary.
- When at least an inch of wire sticks out past the end of the gun, release the trigger.
- Slide the contact tip (L) over the wire protruding from the end of the gun (M). Screw the contact tip into the end of the gun and hand tighten securely.
- Install the nozzle (K) on the gun assembly.

- Cut off the excess wire that extends past the end of the nozzle.
- Fine-tune the wire drive pressure with the pressure arm adjustment knob (G).
- Turn the pressure adjustment knob clockwise to increase the driving pressure until the wire seems to feed smoothly without slipping.
Note: If TOO MUCH pressure is applied, you can crush the wire and create wire feeding problems. If TOO LITTLE pressure is used, the wire will slip on the drive rolls, and no wire will be fed.
- When the driving pressure is set correctly, there should be no slippage between the wire and the drive roller. But if an obstruction occurs along the wire feed path, the wire should slip on the drive roller. You can check it by squeezing the wire between two fingers with moderate force as it comes out of the gun. If this stops the wire from feeding, increase the pressure until the wire feeds through your fingers without issue.
- Double-check your spool tension: When wire feeding stops, the wire comes off the spool with some curvatures while it should not relax so much that the wire loosens on the spool.

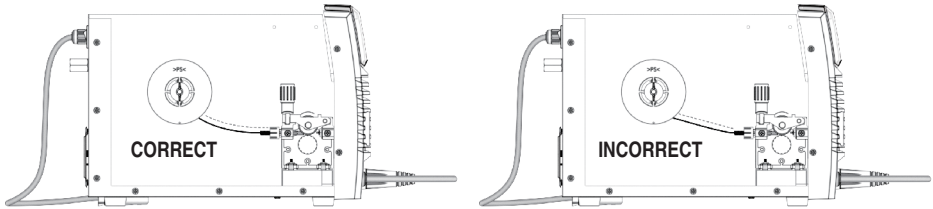

- ⚠️ **KEEP THE GUN STRAIGHT. WHEN FEEDING A NEW WIRE THROUGH THE LINER, MAKE SURE THE WIRE IS CUT CLEANLY (NO BURRS OR ANGLES) AND THAT AT LEAST 1" FROM THE END IS STRAIGHT (NO CURVES). FAILURE TO FOLLOW THESE INSTRUCTIONS COULD CAUSE DAMAGE TO THE LINER.**
- ⚠️ **WHEN CHECKING THE CORRECT EXIT OF THE WIRE FROM THE GUN DO NOT BRING YOUR FACE NEAR THE GUN. YOU MAY RUN THE RISK OF BEING WOUNDED BY THE OUTGOING WIRE. DO NOT BRING YOUR FINGERS CLOSE TO THE FEEDING MECHANISM WHEN WORKING! THE ROLLS, WHEN MOVING, MAY CRUSH FINGERS. PERIODICALLY CHECK THE ROLLS. REPLACE THEM WHEN THEY ARE WORN AND COMPROMISE THE REGULAR FEEDING OF THE WIRE.**







OPERATION

Performance Data Plate And Duty Cycle

On the machine, there is a plate that includes all the operating specifications for your new unit. The duty cycle rating of a welding machine defines how long the operator can weld and how long the welding machine must rest and be cooled. Duty cycle is expressed as a percentage of 10 minutes and represents the maximum welding time allowed. The balance of the 10-minute cycle is required for cooling.

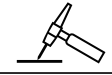
For example, a welding machine has a duty cycle rating of 30% at the rated output of 90A. With that welding machine, you can weld at 90 A output for three (3) minutes out of every 10 min with the remaining seven (7) minutes required for cooling.

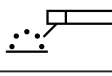
The duty cycle of your new welding machine can be found on the data plate affixed to the machine. The picture below shows that the "X" row lists duty cycle percentages while the "I2" row lists the amp draw corresponding to the duty cycle. Various duty cycles at other amperages are listed on your data plate.

MODEL: YWM-211P		S/N:					
		ANSI/IEC STD.60974-1					
	====	U ₁ =110V			U ₁ =220V		
		30A/15.5V~160A/22V			30A/15.5V~200A/24V		
		X	60%	100%	X	60%	100%
	U ₀ =72V	I ₂	160A	123A	I ₂	200A	158A
		U ₂	22V	20.1V	U ₂	24V	21.9V
		U ₁ =110V			U ₁ =220V		
	====	10A/10.4V~160A/16.4V			10A/10.4V~200A/18V		
		X	60%	100%	X	60%	100%
		I ₂	160A	124A	I ₂	200A	155A
	U ₀ =72V	U ₂	16.4V	15V	U ₂	18V	16.2V
		U ₁ =110V			U ₁ =220V		
		20A/20.8V~145A/25.8V			20A/20.8V~180A/27.2V		
	====	X	60%	100%	X	60%	100%
		I ₂	145A	112A	I ₂	180A	139A
		U ₂	25.8V	24.5V	U ₂	27.2V	25.5V
	U ₁ =110V	I ₁ max=50A		I ₁ eff=38.7A			
	U ₁ =220V	I ₁ max=34A		I ₁ eff=26.3A			
Cooling Mode: Fan Cooling				Insulation Grade: F		IP21S	

Internal Thermal Protection

If you exceed the welding machine duty cycle, the thermal protection system will engage, shutting off all welding current output. After cooling, the thermal protector will automatically reset, and the welding functions can resume. The user needs to know it is the expected behavior of this machine. However, it would be best if you waited at least ten minutes after the thermal protector engages before resuming welding. You must do this even if the thermal protector resets itself before the ten minutes is up, or you may experience less than specified duty cycle performance.

CAUTION: DO NOT REGULARLY EXCEED THE DUTY CYCLE OR DAMAGE TO THE WELDER CAN RESULT.

Welding Preparation

The key to making a good weld is preparation. It includes studying the process and equipment and practicing welding before attempting to weld the finished product. An organized, safe, ergonomic, comfortable, and well-lit work area should be prepared for the operator. The work area should be free of all flammables, with a fire extinguisher and a bucket of sand available to smother potential possible fires.

To properly prepare for welding with your new welder, it is necessary to:

- Read the safety precautions at the front of this manual.
- Prepare an organized, well-lit work area.
- Protect the eyes and skin of the operator and bystanders.
- Attach the work clamp to the bare metal to be welded, ensuring good contact.
- When MIG/MAG, Aluminum Welding, ensure that the wire-roller groove in the roller corresponds to the diameter and type of wire used.
- Plug the machine into a suitable power outlet, and recommend NEMA6-50.
- Completely open the gas cylinder valve. Adjust the gas pressure regulator to the correct flow rate. (Not applicable to Stick welding / SMAW).



EXPOSURE TO A WELDING ARC IS EXTREMELY HARMFUL TO THE EYES AND SKIN. PROLONGED EXPOSURE TO A WELDING ARC CAN CAUSE BLINDNESS AND BURNS. NEVER STRIKE AN ARC OR BEGIN WELDING UNLESS YOU ARE ADEQUATELY PROTECTED. WEAR FIRE RESISTANT WELDING GLOVES, HEAVY LONG SLEEVED SHIRT, CUFFLESS PANTS; HIGH TOPPED SHOES AND A WELDING HELMET.

Welding Wire Selection

This welder can work with solid steel wire from .023"-.035" (0.6-0.9mm) diameter (MIG welding, "GMAW"), with .030" and .035" stainless steel wire and with .035"-.045" (0.9-1.2mm) Silicon and Magnesium aluminum wire in Aluminum welding.

Gas Selection

Select the appropriate shielding gas by the welded material and wire used. The table below provides you useful instructions:

METAL	GAS	NOTE
Mild Steel	100% CO ₂ 75% Argon + 25% CO ₂	Argon controls spatter For Stainless, recommend mix gas, if not available, 100% Argon will work
Stainless Steel	98% Argon + 2% CO ₂ /100% Argon	
Aluminum	100% Argon	

Set up for MIG Welding (GMAW)



- Connect the MIG gun into the EURO CONNECT SOCKET.
- Connect the wire drive polarity lead(10) to the POSITIVE (+) SOCKET.
- Connect the work clamp to the NEGATIVE (-) SOCKET. Ensure the work clamp has a good connection to the workpiece and is connected on clean, bare metal (not rusty or painted).
- Load the spool of wire inside the cabinet and feed it through the WIRE FEEDER into the gun (see "Installing the Welding Wire", page 11).
- Connect the gas line to the regulator and connect to the gas cylinder.
- Note: 100% Argon for Al Si/Al Mg, 75 Argon 25% CO₂/80% Argon 20% CO₂ for Fe Mix and 100% CO₂ for Fe CO₂, 98% Argon 2% CO₂ for Stainless Steel.
- Press the gun trigger or inching button (2) to load the wire through the gun.
- Turn on the gas cylinder, pull the trigger to check for gas flow and set the flow rate to between 20-30 CFH.
- Turn the power source on and select the MIG/Pulesd MIG function with the MIG/Pulsed MIG/Lift TIG/Stick selector switch.
- Press material selection button to choose material Al Si, Al Mg, Fe Mix, Fe CO₂, Stainless Steel.
- Select the wire diameter.
- Set torch operation 2T/4T/4TL/spot.

2T Mode:

1. Push the torch trigger: arc is ignited and the machine goes to the selected working amperage.
2. Release the torch trigger: current drops and arc stops.

4T Mode:

1. Push the torch trigger: arc is ignited and the machine start to arc the selected working amperage.
2. Release it: stay at the working amperage .
3. Push it again: the amperage slop down to the ending amperage (pilot arc current I2).
4. Release it: arc stops.

4TL Mode:

1. Push the torch trigger: arc is ignited and current reaches to the start amperage (initial arc current I1).
2. Release it: the machine will slope up to the selected welding amperage.
3. Push it again: the amperage slop down to the finishing amperage (pilot arc current I2).
4. Release it: arc stops.

Spot Welding Mode:

1. Push the torch trigger: arc is ignited and current rises to the preset value.
2. When the spot welding time is up, current drops gradually, and arc stops.

The amount of time that the arc will be active before it shuts off automatically. Range of setting is from 0-15 seconds. Spot timer is reset upon release of welding gun trigger.

- Press the menu button and choose weld spec selection, rotate the value adjustment knob (1) to change the parameters as below.
- Trigger the torch control switch to feed wire and start welding.

How To Choose Synergic MIG

Synergic MIG this is a predefined setting based on Gas and wire used. The machine will preselect voltage and amperage allowing the user to quickly find the best welding parameters.

Simply select the correct wire diameter and gas type that you're using then dial in your desired wire feed speed for the job. Use more wire speed for thicker material and less wire speed for thinner material. The Synergic MIG system will auto-adjust the welding voltage to give you an ideal arc condition while welding.

1. Enter the menu button (6).
2. Select the weld spec.
3. Find the parameter Syn and turn on it via Value Adjustment/Gas Checking Knob (1).
4. Adjust the value adjustment knob (1) to change the output amperage, the wire feeding speed will automatically changed.
5. Adjust the Voltage/Function knob (2) to fine-adjust the voltage from -3-3V.

Details for Setting for Manual MIG

Mode:	Torch Mode	Weld Spec	Value
Synergic MIG Syn on	2T/4T/4TL/Spot	ind.	(-10~10)(%)
	2T/4T/4TL/Spot	rin	0~10(%)
	2T/4T/4TL/Spot	hs	0~10(%)
	2T/4T/4TL/Spot	prg	0~20s
	2T/4T/4TL/Spot	pog	0~20s
	2T/4T/4TL/Spot	bbt	0~10(%)
	2T/4T/4TL/Spot	syn	OFF/ON
	4TL	I1(Stop Amperage)	30~200A
	4T/4TL	I2(Stop Amperage)	30~200A
	SPOT	SPT	0~15s
110V	Material	size	Amp
	AL Si	0.9mm/.035"	75~160
	AL Si	1.2mm/.045"	90~160
	Al Mg	0.9mm/.035"	65~160
	Al Mg	1.2mm/.045"	70~160
	SS	0.8mm/.030"	40~160
	SS	0.9mm/.035"	45~160
	Fe Mix	0.6mm/.023"	40~160
	Fe Mix	0.8mm/.030"	40~160
	Fe Mix	0.9mm/.035"	60~160
	Fe CO ₂	0.6mm/.023"	40~160
	Fe CO ₂	0.8mm/.030"	40~160
Fe CO ₂	0.9mm/.035"	52~160	
220V	Material	size	Amp
	AL Si	0.9mm/.035"	75~200
	AL Si	1.2mm/.045"	90~160
	Al Mg	0.9mm/.035"	65~200
	Al Mg	1.2mm/.045"	70~200
	SS	0.8mm/.030"	40~200
	SS	0.9mm/.035"	45~200
	Fe Mix	0.6mm/.023"	40~200
	Fe Mix	0.8mm/.030"	40~200
	Fe Mix	0.9mm/.035"	60~200
	Fe CO ₂	0.6mm/.023"	40~200
	Fe CO ₂	0.8mm/.030"	40~200
	Fe CO ₂	0.9mm/.035"	52~200

How To Choose Manual MIG

Manual MIG allows separate setting for welding parameters such as the wire feed speed and voltage. Refer to weld chart along with the package for proper parameter settings according to wire type, shielding gas, and material type and thickness.

1. Enter the menu button (6).
2. Select the weld spec.
3. Find the parameter Syn and turn off it via value adjustment knob (1).
4. Adjust the adjustment knob (1) to change the wire feeding speed (WFS).
5. Adjust the Function knob (2) to change the output Voltage.

Details for Setting for Manual MIG

Mode:	Torch Mode	Weld Spec	Value
Manual MIG Syn off	2T/4T/4TL/Spot	ind:	(-10~10)(%)
	2T/4T/4TL/Spot	rin	0~10(%)
	2T/4T/4TL/Spot	hs	0~10(%)
	2T/4T/4TL/Spot	prg	0~20s
	2T/4T/4TL/Spot	pog	0~20s
	2T/4T/4TL/Spot	bbt	0~10(%)
	2T/4T/4TL/Spot	syn	Off/On
	4TL	I1(Stop Amperage)	1.5~15m/min
	4T/4TL	I2(Stop Amperage)	1.5~15m/min
	4TL	U1(Start Voltage)	9~27.5V
	4T/4TL	I2(Stop Amperage)	9~27.5V
	SPOT	SPT	0~15s
	110V/220V		
Material	Size	Voltage	Wire feed speed m/min
AL Si	0.9mm/.035"	9~27.5V	1.5~15m/min
	1.2mm/.045"		
Al Mg	0.9mm/.035"		
	1.2mm/.045"		
SS	0.8mm/.030"		
SS	0.9mm/.035"		
Fe Mix	0.6mm/.023"		
Fe Mix	0.8mm/.030"		
Fe Mix	0.9mm/.035"		
Fe CO ₂	0.6mm/.023"		
Fe CO ₂	0.8mm/.030"		
Fe CO ₂	0.9mm/.035"		

How To Choose Pulsed MIG

In Pulse MIG mode there is no manual voltage adjustment; instead, voltage is synergically aligned with the proper wire feed speed. Arc length can be adjusted from -3V to +3V. Arc Length adjustment is used to adjust actual arc length which automatically adjusts the voltage from -3V to +3V. Adjusting the Arc Length will vary the length of the welding arc cone. See weld chart in front compartment for proper wire feed speed adjustment according to wire size and type.

1. Select the MIG/Pulse MIG function with the MIG/Pulsed MIG/Lift TIG/Stick selector switch.
2. Press menu and choose Double Pulse.
 - a. On, Double Pulse MIG welding is on, able to adjust pulse spec: BS (Base current), FRQ (frequency) and Duy (duty cycle)
 - b. Off, Single Pulsed MIG welding is on, default pulse spec, not able to adjust.
3. Set the welding parameters.
4. Adjust the value adjustment knob (1) to change the output amperage, the wire feeding speed will automatically changed.
5. Details for Setting for Pulsed/Double Pulsed MIG Adjust the Voltage/Function knob (2) to micro-adjust the arc length.

Details for Setting for Pulsed/Double Pulsed MIG

Mode:	Torch Mode	Weld Spec	Value
Pulsed MIG/Double Pulsed MIG DP off	2T/4T/4TL	ind:	(-10~10)(%)
	2T/4T/4TL	rin	0~10(%)
	2T/4T/4TL	hs	0~10(%)
	2T/4T/4TL	prg	0~20s
	2T/4T/4TL	pog	0~20s
	2T/4T/4TL	bbt	0~10(%)
	2T/4T/4TL	DP	Off/On
	4TL	I1(slope up arc start amperage/current)	same as the amp range
	4T/4TL	I2(top stop amperage)	same as the amp range
	4TL	U1(start voltage)	-5~5V
	4T/4TL	U2(stop voltage)	-5~5V
	2T/4T/4TL	SPT	0~15s
	Pulsed Spec:DP ON		IBS
		FRQ	0-5HZ
		DUY	10-80%
110V	Material	Size	AMP(A)
	AL Si	0.9mm/.035"	25~160
	AL Si	1.2mm/.045"	32~160
	Al Mg	0.9mm/.035"	25~160
	Al Mg	1.2mm/.045"	30~160
	SS	0.8mm/.030"	25~160
	SS	0.9mm/.035"	35~160
	Fe Mix	0.8mm/.030"	30~160
Fe Mix	0.9mm/.035"	40~160	
220V	Material	Size	AMP(A)
	AL Si	0.9mm/.035"	25~200
	AL Si	1.2mm/.045"	32~200
	Al Mg	0.9mm/.035"	25~200
	Al Mg	1.2mm/.045"	30~200
	SS	0.8mm/.030"	25~200
	SS	0.9mm/.035"	35~200
	Fe Mix	0.8mm/.030"	30~200
Fe Mix	0.9mm/.035"	40~200	

Note: In 4T mode, it's able to adjust the stop amperage and voltage, while the 4TL could adjust stop amperage and voltage, at the same time, start amperage and voltage.

Initial current (I1), welding current (I) & pilot arc current (I2): The preset value of the three parameters is approximately the absolute average of the practical welding current, and can be adjusted according to user's technical requirements.

- Initial current (I1): It is the current when arc is ignited by pushing the torch trigger, and it should be set according to users' own technical requirements. If the initial current is high enough, arc is easier to ignite. However, it should not be too high when welding thin plate, so as to avoid burn through the workpiece during arc ignition. In some operation modes, the current does not rise but stay at the initial current value to preheat the workpiece or illuminate.
- Pilot arc current (I2): In some operation modes, the arc does not stop after current downslope but stay in the pilot arc state, The working current in this state is called pilot arc current, and it should be set according to users' technical requirements.
- Initial Voltage (U1): It is the voltage when arc is ignited by pushing the torch trigger, and it should be set according to users' own technical requirements.
- Pilot Arc Voltage(U2): It is the voltage when arc is stay in the pilot arc state and it should be set according to users' own technical requirements.

Details for 4T/4TL Modes

Mode:	Torch Operation		4T			4TL				
	Voltage		110V			220V				
	Material	Wire Dia.	I/SPD	I2	U2	I	I1	I2	U1	U2
	Synergic MIG Syn on	AL Si	0.9mm/.035	70~160A	30~160A	-	70~200A	30~200A	30~200A	-
AL Si		1.2mm/.045	90~160A	30~160A	-	90~200A	30~200A	30~200A	-	-
Al Mg		0.9mm/.035	65~160A	30~160A	-	65~200A	30~200A	30~200A	-	-
Al Mg		1.2mm/.045	70~160A	30~160A	-	70~200A	30~200A	30~200A	-	-
SS		0.9mm/.035	40~160A	30~160A	-	40~200A	30~200A	30~200A	-	-
SS		0.8mm/.030	45~160A	30~160A	-	45~200A	30~200A	30~200A	-	-
Fe Mix		0.6mm/.023	40~160A	30~160A	-	40~200A	30~200A	30~200A	-	-
Fe Mix		0.8mm/.030	40~160A	30~160A	-	40~200A	30~200A	30~200A	-	-
Fe Mix		0.9mm/.035	60~160A	30~160A	-	60~200A	30~200A	30~200A	-	-
Fe CO2		0.6mm/.023	40~160A	30~160A	-	40~200A	30~200A	30~200A	-	-
Fe Co2		0.8mm/.030	40~160A	30~160A	-	40~200A	30~200A	30~200A	-	-
Fe Co2		0.9mm/.035	52~160A	30~160A	-	52~200A	30~200A	30~200A	-	-
Manual MIG Syn off	AL Si	0.9mm/.035 1.2mm/.045	1.5~15M/Min	1.5~15M/Min	9~27.5V	1.5~15M/Min	1.5~15M/Min	1.5~15M/Min	9~27.5V	9~27.5V
	Al Mg	0.9mm/.035 1.2mm/.045	1.5~15M/Min	1.5~15M/Min	9~27.5V	1.5~15M/Min	1.5~15M/Min	1.5~15M/Min	9~27.5V	9~27.5V
	SS	0.8mm/.030	1.5~15M/Min	1.5~15M/Min	9~27.5V	1.5~15M/Min	1.5~15M/Min	1.5~15M/Min	9~27.5V	9~27.5V
	SS	0.9mm/.035	1.5~15M/Min	1.5~15M/Min	9~27.5V	1.5~15M/Min	1.5~15M/Min	1.5~15M/Min	9~27.5V	9~27.5V
	Fe Mix	0.6mm/.023	1.5~15M/Min	1.5~15M/Min	9~27.5V	1.5~15M/Min	1.5~15M/Min	1.5~15M/Min	9~27.5V	9~27.5V
	Fe Mix	0.8mm/.030	1.5~15M/Min	1.5~15M/Min	9~27.5V	1.5~15M/Min	1.5~15M/Min	1.5~15M/Min	9~27.5V	9~27.5V
	Fe Mix	0.9mm/.035	1.5~15M/Min	1.5~15M/Min	9~27.5V	1.5~15M/Min	1.5~15M/Min	1.5~15M/Min	9~27.5V	9~27.5V
	Fe Co2	0.6mm/.023	1.5~15M/Min	1.5~15M/Min	9~27.5V	1.5~15M/Min	1.5~15M/Min	1.5~15M/Min	9~27.5V	9~27.5V
	Fe Co2	0.8mm/.030	1.5~15M/Min	1.5~15M/Min	9~27.5V	1.5~15M/Min	1.5~15M/Min	1.5~15M/Min	9~27.5V	9~27.5V
	Fe Co2	0.9mm/.035	1.5~15M/Min	1.5~15M/Min	9~27.5V	1.5~15M/Min	1.5~15M/Min	1.5~15M/Min	9~27.5V	9~27.5V
Pulsed MIGDP off	AL Si	0.9mm/.035	25~160A	25~160A	-5~5V	25~200A	25~200A	25~200A	-5~5V	-5~5V
	AL Si	1.2mm/.045	32~160A	32~160A	-5~5V	32~200A	32~200A	32~200A	-5~5V	-5~5V
	Al Mg	0.9mm/.035	25~160A	25~160A	-5~5V	25~200A	25~200A	25~200A	-5~5V	-5~5V
	Al Mg	1.2mm/.045	30~160A	30~160A	-5~5V	30~200A	30~200A	30~200A	-5~5V	-5~5V
	SS	0.8mm/.030	25~160A	25~160A	-5~5V	25~200A	25~200A	25~200A	-5~5V	-5~5V
	SS	0.9mm/.035	35~160A	35~160A	-5~5V	35~200A	35~200A	35~200A	-5~5V	-5~5V
	Fe Mix	0.8mm/.030	30~160A	30~160A	-5~5V	30~200A	30~200A	30~200A	-5~5V	-5~5V
	Fe Mix	0.9mm/.035	40~160A	40~160A	-5~5V	40~200A	40~200A	40~200A	-5~5V	-5~5V
Double Pulsed MIG	AL Si	0.9mm/.035	25~160A	25~160A	-5~5V	25~200A	25~200A	25~200A	-5~5V	-5~5V
	AL Si	1.2mm/.045	32~160A	32~160A	-5~5V	32~200A	32~200A	32~200A	-5~5V	-5~5V
	Al Mg	0.9mm/.035	25~160A	25~160A	-5~5V	25~200A	25~200A	25~200A	-5~5V	-5~5V
	Al Mg	1.2mm/.045	30~160A	30~160A	-5~5V	30~200A	30~200A	30~200A	-5~5V	-5~5V
	SS	0.8mm/.030	25~160A	25~160A	-5~5V	25~200A	25~200A	25~200A	-5~5V	-5~5V
	SS	0.9mm/.035	35~160A	35~160A	-5~5V	35~200A	35~200A	35~200A	-5~5V	-5~5V
	Fe Mix	0.8mm/.030	30~160A	30~160A	-5~5V	30~200A	30~200A	30~200A	-5~5V	-5~5V
	Fe Mix	0.9mm/.035	40~160A	40~160A	-5~5V	40~200A	40~200A	40~200A	-5~5V	-5~5V

Set up for Aluminum Welding With Spool Gun

- Install optional YesWelder LBT150 spool gun into Euro MIG torch connection socket on the front panel, and tighten it. Connect the Spool Gun control cable to the receptacle and tighten it.

IMPORTANT: When connecting the torch, be sure to tighten the connection. A loose connection can result in the connector arcing and damaging the machine and gun connector. This type of damage is not covered under warranty.

- Plug the 2-pin gun trigger connector into the Spool Gun Trigger Connector Receptacle.
- Connect to Wire Drive Polarity (+) Lead to the Positive socket.
- Connect the Work Clamp into the Negative (-) socket.
- Connect the gas line to the regulator and connect to the gas cylinder with 100% Argon shielding Gas.
- with 100% Argon shielding Gas.
- Push the Cover Release clip on the spool gun to unlock the wire housing cover.
- Place the spool of welding wire on the spool holder, correctly putting the parts back on. (Note: the tensioner part needs to remove first, and remember to put it back.)
- Hold and snip the wire. (IMPORTANT: wire can uncoil quickly without an appropriate holding)
- Put the wire into the groove of the drive roller, and feed it through the outlet guide tube into the torch. Ensure the wire being used complies with the size of the roller groove.
- Adjust the spool holder's tension to enable a smooth and stable wire feeding.
- Remove the gas nozzle and contact tip from the welding torch.
- Pull the trigger to feed the wire until it exits the contact tip holder.
- Install a correct-sized contact tip, screw the contact tip into the tip holder of the torch, and tighten it up.
- Install the gas nozzle to the torch head and close the wire spool cover.
- Turn the power source on and choose the Manual MIG function with the selector button (3).
- Press Menu button and select weld spec with Syn off.
- Choose the material, Aluminum with the selector button (2)
- Set gun selector toggle switch to Spool Gun inside the wire feeding door.
- Turn on the gas cylinder valve and set the flow rate to between 20-30 CFH.
- Set the welding parameters and begin aluminum welding.



- Install optional YesWelder LBT150 spool gun into Euro MIG torch connection socket on the front panel, and tighten it. Connect the Spool Gun control cable to the receptacle and tighten it.



- Push the Cover Release clip on the spool gun to unlock the wire housing cover.



- Place the wire on the spool holder, taking care to put the parts back on correctly. (Note: the tensiometer part needs to be removed first and remembered to be put back.)



- Place the spool of welding wire on the spool holder, correctly putting the parts back on. (Note: the tensiometer part needs to be removed first, and remember to put it back.)



- Adjust the spool holder's tension to enable a smooth and stable wire feeding.



- Remove the gas nozzle and contact tip from the welding torch.



- Install a correct-sized contact tip, screw the contact tip into the tip holder of the torch, and tighten it up.



- Turn the power source on and select the Manual MIG function with the MIG/Pulse MIG/Lift TIG/Stick selector switch with Syn off.



- Set gun selector toggle switch to Spool Gun inside the wire feeding door.

Set up for Aluminum Welding With MIG Gun With Graphene Liner

- (1) Lay the gun straight on the ground and remove consumables on the front-end parts.
- (2) Remove the liner retaining nut.
- (3) Pull the steel wire feed liner out of the gun cable assembly.
- (4) Unravel the graphene wire feed liner and feed the liner in short forward movements down the cable assembly all the way through and out the torch end. Avoid kinking the liner. Kinking the liner will damage it and require replacement.
- (5) Place the tip holder over the end of the liner and, screw it into the torch neck, tighten it up. Reassemble the consumables with a special aluminum A+ contact tip, nozzle, and gas diffuser.
- (6) Fit the O-ring, and liner retaining nut.
- (7) Push the liner firmly into the torch lead and tighten the liner retaining nut.
- (8) Disengage the drive roller.
- (9) Use a screwdriver or other sharp object to push out outlet guide tube through the Euro connector.
- (10) Loosen off the outlet guide tube retaining screw.
- (11) Remove the outlet guide tube from the front-end euro connector using long nose pliers.
- (12) Unscrew the inlet guide tube from the wire feeding mechanism.
- (13) Feed the extended graphene liner section into the outlet guide tube hole of the machine Euro connector.
- (14) Feed the extended graphene liner up and over the drive roller.
- (15) Tighten the torch Euro connection to the machine Euro connector.
- (16) Cut the extended liner with a sharp knife.
- (17) Install the correct sized U Knurled Drive roller, and feed the correct diameter of aluminum welding wire.
- (18) Remove the metal tube from the inlet guide tube.
- (19) Cut a slightly longer tube based on the metal guide tube.
- (20) Replace the inlet guide tube with the graphene liner and re-install the inlet guide to the wire feeding mechanism.
- (21) Install the aluminum spool and feed the wire through.
- (22) Set the welding parameters via Synergic MIG or Manual MIG.

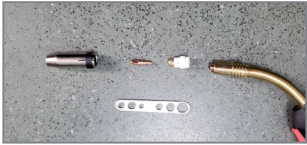

- Remove the MIG torch consumables.



- Remove the liner retaining nut.

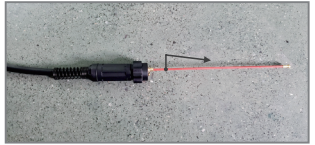

- Pull out the liner completely.



- Untie the new liner.

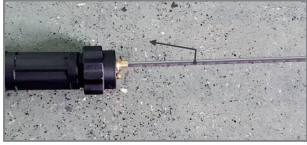

- Feed the liner in short forward movements down the cable assembly all the way through and out the torch end.



- Install a matched contact tip and other front-end accessories to the torch. It is ready for welding.

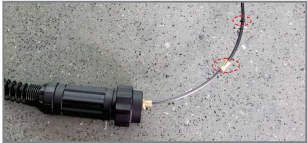

- Push the liner firmly into the torch lead and tighten retaining nut.



- Disengage the drive roller.



- Use a screwdriver or other sharp object to push out outlet guide tube through the Euro connector.



- Loosen the outlet guide tube screw.



- Remove the outlet guide tube from the front-end euro connector using long nose pliers.



- Unscrew the inlet guide tube from the wire feeding mechanism.



- Feed the extended graphene liner into the outlet guide tube hole of the machine Euro connector.



- Feed the extended graphene liner over the drive roller into the inlet guide tube part.



- Tighten the torch Euro connection to the Euro connector.

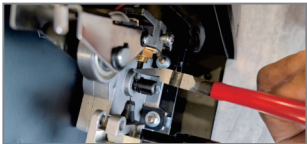

- Cut the extended liner with a sharp knife. The remaining part should be about 14ga-12ga away from the wire drive roller.



- Install the correct sized U Knurled Drive roller, and with the correct diameter knurl inside.



- Remove the metal tube from the inlet guide tube.

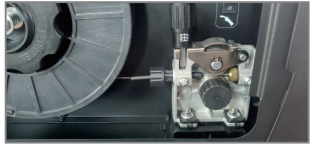
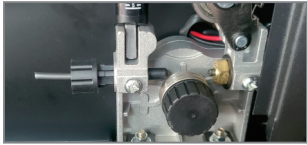

- Cut a slightly longer tube based on the metal guide tube.
- Replace the inlet guide tube with the graphene liner and re-install the inlet guide to the wire feeding mechanism.
- Install the aluminum spool and feed the wire through.

Set up for Memory Saving And Loading

The Memory function allows to store the voltage, current settings and other welding parameter that match the suitable welding setting under memory channel. The memory channel can be recalled to reveal and use the weld parameters stored, and weld parameters can be further adjusted and stored as required.

Up to 9 memory options for welding can be memorized and stored for recall.

1. Set the welding parameters with the best welding effect in practicing.
2. Press the Memory Saving and Loading Button (8) on the panel.
3. Rotate the value adjustment knob (2) to choose the channel (CH) number for memory.
4. Save the channel.
5. Load the memorized channel number for recalling the welding parameters.

Set up for Lift Arc TIG Welding (GTAW)



Setting up the Equipment for TIG Welding (GTAW): TIG torch is not included, additional YesWelder WP-17V-35 Lift TIG torch and Lanthanated Tungsten are recommended for use.



WARNING: TIG TORCH IS ALWAYS LIVE (ELECTRICALLY HOT). Use caution and ensure the TIG torch is not in contact with or close to a conductive or grounded material.

- Remove the Wire Drive Polarity Lead from the POSITIVE (+) and NEGATIVE (-) SOCKETS.
- Connect the TIG torch cable to the welder's NEGATIVE(-) SOCKET.
- Connect the work cable connector to the welder's POSITIVE(+) SOCKET.
- Ensure the work clamp has good contact with the workpiece on a clean, bare metal surface free of rust, paint, or coating.
- Connect the TIG torch gas line to the gas regulator (argon gas only).

USE INERT GAS (100% ARGON) ONLY.

TURN ON GAS AT THE GAS REGULATOR, CHECK FOR GAS FLOW AND ADJUST FLOW RATE AS NEEDED.

- Set the tungsten electrode to stick out approximately 1/4" inch from the end face of the gas cup. Please use the correct size and type of tungsten electrode in your project. The small size of tungsten can handle the low welding current. The tungsten electrode requires a sharpened tip in direct current (DC) welding.
- Put the TIG torch away from all conductive materials.
- Turn on the welder's power SWITCH.
- Select the Lift TIG process with the PROCESS SELECTOR BUTTON on the front panel.
- Turn on the valve of the gas cylinder, and set the flow to 20-30 CFH.
- Set the welding current/amperage through the Adjustment Knob (1).
- Turn the valve on the TIG torch to start the shielding gas flow.
- Initiate the welding arc with a lift arc technique - touch the workpiece surface with the tip of the tungsten electrode slightly, then lift it as shown in the picture below. The machine will instantly ramp up the voltage and current to establish the arc.

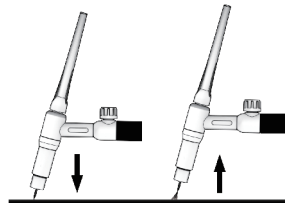

REMEMBER TO CLOSE THE VALVE ON THE GAS CYLINDER IMMEDIATELY AFTER ALL WELDING IS COMPLETED.

Welding Tips:

- Always weld clean, dry and well-prepared material.
- Hold the torch at a 45° angle to the workpiece with gas cup about 1/2" from the surface.
- Move the torch smoothly and steadily as you weld.
- Avoid welding in very drafty areas. A draft will fail the shielding gas protection and lead to a porosity defect.
- Keep wire and liner clean. Do not use rusty or dirty wire.
- Please don't bend or kink the welding torch cable. Doing so will restrict the gas flow and damage the cables.

Set up for Stick Welding (SMAW)



- Remove the Wire Drive Polarity Lead from the POSITIVE (+) or NEGATIVE (-) SOCKETS (Remove the MIG torch at the same time).
- Check the electrode packaging to determine the recommended polarity and connect the electrode stringer and work clamp to the POSITIVE (+) or NEGATIVE (-) SOCKETS accordingly.
- Place the electrode into the electrode holder firmly.
- Ensure the work clamp has good contact with the workpiece on a clean, bare metal surface free of rust, paint, or coating.

Note: For Stick welding, DCEP means the electrode holder is connected to the positive socket while the work clamp (workpiece) is connected to the negative socket.

However, various electrodes require a different polarity for optimum results. Please follow the electrode manufacturer's recommendation on the correct polarity.

Electrode	Polarity	Usage
E7018, E6011, E6013	DCEP	This electrode is best for use with clean, bare steel and is suitable for moderate penetration.
E6010	DCEN	This electrode is usually used for building up heavy deposits of material with less penetration and thin sheet welding.

- Turn the power source on and select the Stick function with Process Selection Button on the front panel.
- Set the amperage with the Adjustment Knob (1).
- Strike the electrode against the workpiece to create an arc and hold the electrode steady to maintain the arc.
- Hold the electrode slightly above the work, maintaining the arc while traveling at an even speed.
- To finish the weld, break the arc by quickly snapping the electrode away from the workpiece.
- Wait for the weld to cool and carefully chip away the slag to reveal the weld metal below.

Welding Current Guide

Choosing the correct current for a particular welding job is critical. If the welding current is too low, the user will experience difficulty in striking and maintaining a stable arc. The electrode tends to stick to the workpiece, penetration is poor, and the weld ends up with a rounded profile. If the current is too high, the problems include burning through the base metal, undercut, and excessive spatters. The standard welding current for a particular job should be the maximum that won't burn through the base metal, overheat the tungsten electrode, or leave spatters sticking to the workpiece surface.

The table shows current ranges generally recommended for a general purpose type E6013 electrode.

Electrode Size ϕ mm/Inch	Current Range (Amps)
3/32" or 0.09" (2.4mm)	60-95
1/8" or 0.125" (3.2mm)	100-130
11/64" Or 0.15" (4.0mm)	130-165
13/64" or 0.19" (5.0mm)	165-260

In SMAW mode, the user can adjust four parameters directly. The description is as follows:

VRD Optional:

The VRD feature is not embedded in the welder. It's available as an option. A voltage reduction device (VRD) is a hazard reduction device that lowers the welder's open circuit voltage (OCV) to prevent electric shock from welding current. A VRD is usually equipped with a stick welding machine in wet environments or conductive confined spaces. The designated open circuit voltage (OCV) is not present before the electrode touches the workpiece. Instead, a low voltage for sensing purposes is presented between electrode and workpiece. It allows the electrode to touch the workpiece without overheating, sticking, or contamination.

Arc Force Adjustable:

Arc force is a momentarily increase of the welding current during welding when the machine senses the drop of the arc voltage caused by a short arc length. Arc force compensates for the voltage drop by increasing the amperage. Increased amperage ensures that the heat stays the same and that the electrode will not dip into the base metal. This function dramatically helps stabilize the arc, prevent the arc from cutting out in the welding process, and prevent the electrode from sticking to the workpiece.

Arc force should be set according to the electrode diameter, preset current and the technical requirement. If the arc force is big, the molten drop can be transferred quickly, and electrode sticking seldom occurs. However, too big arc force may lead to excessive spatter. If the arc force is small, there will be little spatter, and the weld bead will be shaped well. However, too small arc force may lead to soft arc and electrode sticking. Therefore, the arc force should be increased when welding with thick electrode under low current.

In general welding operation, the user can set the arc force between 1 and 10. For example, when the preset current is 50A, and the arc force is 2, the actual welding current will be 60A. However, when the current increases to the maximum allowable value of 200A, the welding current won't ascend anymore.

Hot Start Adjustable

Hot start is a feature that pumps up the amperage for a short time when you start the arc. Higher amperage helps to start the arc easier without sticking the electrode to the base metal. A hot start helps warm the base metal to achieve deep penetration at the weld start.

The hot start is essential, especially in working conditions such as damp electrodes, imperfect job surfaces, or when using 'difficult to run' electrodes, etc.

Set the hot start amp with a range of 1 to 10. One example, if the preset current is 50A and the hot start amp is set at 2, the hot start current will be 60A. The current will return to 50A after the arc establishes successfully.

Anti-Stick Optional:

The anti-stick feature is not embedded in the welder. It's available as an option.

Anti-stick is a feature that will take action when the electrode contacts the base metal. When the machine senses that the electrode touches the workpiece, it will automatically cut off the welding current. This feature prevents the electrode from welding into the workpiece and the welding machine from overloading. With the anti-stick function, breaking the electrode from the workpiece is effortless.

MAINTENANCE & SERVICING

General Maintenance

This welder has been engineered to need minimal service providing that a few very simple steps are taken to properly maintain it.

- Keep the cabinet cover closed at all times unless the wire needs to be changed or the driving pressure needs adjusting.
- Keep all consumables (contact tips, nozzles, and liner) clean and replace them when necessary. See "Consumable Maintenance" (below) and "Troubleshooting" (page 27) for detailed information.
- Replace INPUT POWER CABLE, ground cable, work clamp, or gun assembly when damaged or worn.
- Avoid directing grinding particles towards the welder. These conductive particles can build up inside the machine and cause severe damage.
- Periodically clean dust, dirt, grease, etc. from your welder. Every six months or as necessary, remove the side panels from the welder and use compressed air to blow out any dust and dirt that may have accumulated inside the welder.



• If available, use compressed air to clean the liner periodically, especially when changing wire spools
WARNING: DISCONNECT FROM POWER SOURCE WHEN CARRYING OUT THIS OPERATION.

- The wire feed drive roller could wear out during service. Therefore, replacing the drive roller is required under specific circumstances. For example, if the idler roller and the wire feed drive roller make contact when the correct size of welding wire in the groove of the drive roller, the wire feed drive roller must be replaced immediately.
- Check all cables periodically. They must be in good condition and not cracked.



WARNING: ELECTRIC SHOCK CAN KILL! Be aware that the ON/OFF SWITCH, when OFF, does not remove power from all internal circuitry in the welder. To reduce the risk of electric shock, always unplug the welder from its AC power source and wait several minutes for electrical energy to discharge before removing side panels.

Consumable Maintenance

IT IS VERY IMPORTANT TO MAINTAIN THE CONSUMABLES TO AVOID THE NEED FOR PREMATURE REPLACEMENT OF THE GUN ASSEMBLY.

MAINTAINING THE CONTACT TIP:

The purpose of the CONTACT TIP is to transfer welding current to the welding wire while allowing the wire to pass through it smoothly.

Always use a contact tip stamped with the same diameter as the wire.

- If the wire burns back into the contact tip, remove it from the gun and clean the hole running through it with an oxygen-acetylene torch tip cleaner or tip drill. If the burned-back wire cannot be removed, the contact tip must be replaced.
- A failure mode of the contact tip is a worn-out hole with enlarged hole size. A worn-out contact tip usually results in unstable arc characteristics and difficult arc starting.

CAUTION: KEEP THE GAS NOZZLE CLEAN!

During the welding, spatter and slag can build up inside the gas nozzle. The user must clean the gas nozzle periodically. Failure to clean and/or replace the gas nozzle in a timely fashion could cause damage to the front end of the gun assembly, which is not replaceable. The inaction results may require the replacement of the entire gun assembly.

Failure to keep the nozzle adequately cleaned can result in the following problems:

If the spattering buildup inside the gas nozzle bridges the gas nozzle and the welding torch, it allows the welding current to pass through the gas nozzle beside the contact tip. This phenomenon causes erratic welds and less weld penetration. In addition, it leads to an overheating of the end of the welding gun and, in turn, damages the welding gun.

TESTING FOR A SHORTED NOZZLE

Arcing between the nozzle and the workpiece means the nozzle is shorted.

Unplug the AC power source, and use an ohmmeter to measure the resistance between the gas nozzle and the contact tip. If the resistance is not unlimited, the nozzle is shorted. Please clean or replace the gas nozzle.

TROUBLESHOOTING

HOW TO USE TROUBLESHOOTING GUIDE

This Troubleshooting Guide is provided to help you locate and fix possible machine malfunctions. follow the three-step procedure listed below.

Step 1. LOCATE PROBLEM (SYMPTOM).

Look under the column labeled "PROBLEM (SYMPTOMS)". This column describes the sign that the machine is showing. Find the listing that best describes the symptom that the machine is exhibiting.

Step 2. POSSIBLE CAUSE.

The second column labeled "POSSIBLE CAUSE", lists the obvious external possibilities that may contribute to the machine symptom.

Step 3. RECOMMENDED COURSE OF ACTION

This column provides a course of action for the possible cause. If you do not understand or cannot perform the Recommended Course of Action safely, contact YESWELDER support@yeswelder.com.

OBSERVE ALL SAFETY GUIDELINES DETAILED THROUGHOUT THIS MANUAL

PROBLEM	POSSIBLE CAUSE	COURSE OF ACTION
Frequent circuit breaker Trips.	Machine is drawing too much amperage due to use of larger size electrode.	Use a smaller electrode.
	Machine is not the only piece of electrical equipment on the circuit.	Make sure the welder is on a dedicated circuit or is the only equipment plugged into a circuit.
	Circuit breaker is incorrect/insufficient for use with this machine.	Verify that the circuit breaker for the circuit is a 50A breaker for 110V and 30A for 220V. If it is not, have a qualified electrician install the proper breakers.
All LEDs OFF, No output power, Fan not operating.	No input power.	Connect machine to proper input power source.
		Verify that circuit breaker has not been tripped in your main power panel. Reset if needed.
		Wire loose connection.
	POWER SWITCH is OFF.	Ensure POWER SWITCH(rear) is in the ON position.

TROUBLESHOOTING

MIG WELDING ISSUES

PROBLEM	POSSIBLE CAUSE	COURSE OF ACTION
No arc or wire feed. Fan operates normally (can be heard).	Gun trigger is not being pulled or is not making contact.	Pull the trigger while in contact with the workpiece. The machine does not arc unless the trigger is pulled. Depress the trigger ALL THE WAY until the trigger stops moving into the gun.
	Exceeded duty cycle; thermal protector engaged.	Allow welder to cool at least 10 minutes with machine ON (observe and maintain proper duty cycle). OVERHEAT INDICATOR should turn off after the machine has cooled.
	Insufficient air flow causing machine to overheat before reaching duty cycle.	Check for obstructions blocking air flow and ensure that there are 12 inches of clearance between any obstacles and the vents on all sides of the machine.
No arc or wire feed. Fan does NOT operate (cannot be heard).	No voltage or incorrect voltage supplied to welder.	Make sure the machine is plugged in. Check the status of your INPUT VOLTAGE INDICATOR LED. It should be illuminated. Check the voltage of your outlet. If it is 10% more or less than optimal, call a qualified electrician.
	ON/OFF SWITCH is in the OFF position.	Turn the ON/OFF SWITCH to the ON position.
	Circuit breaker has been tripped.	Make sure the circuit breaker has been reset.
Feed motor operates but wire will not feed.	Insufficient feed drive roller pressure.	Adjust drive roller pressure.
	Burr on end of wire.	Re-cut wire so it is square with no burr.
	Liner blocked or damaged.	Clear with compressed air or replace liner.
	Despooler tension too high.	Adjust despooler tension.
Wire feeding works but no arc start	Bad ground or loose ground connection.	Check connection of the ground cable to the work clamp. Tighten cable connection to work clamp if needed. Ensure that the connection between the work clamp and workpiece is good and is on clean, bare (not painted or rusted) metal.
	Trigger not pulled while wire is in contact with workpiece.	Pull the trigger while in contact with the workpiece. The machine does not arc unless the trigger is pulled.
Poor quality welds.	Insufficient gas at weld area.	Check that the gas is not being blown away by drafts and, if so, move to a more sheltered weld area. If not, check gas cylinder contents, gauge, regulator setting, and operation of gas valve.
	Rusty, painted, oily or greasy workpiece	Ensure workpiece is clean and dry.
	Poor ground connection or torch/electrode connection.	Check work clamp/workpiece connection and all connections to the machine.
	Incorrect settings.	Check welding parameters and polarity.

TROUBLESHOOTING

MIG WELDING ISSUES

PROBLEM	POSSIBLE CAUSE	COURSE OF ACTION
Arc works but not feeding wire.	No pressure on the drive roller; insufficient or excessive pressure on the drive roller.	Adjust the drive pressure.
	Wire spool is empty.	Check if wire is in place and replace if necessary.
Wire is "bird-nesting" at the drive roller or jamming.	Too much pressure on drive roller.	Adjust the drive pressure.
	The contact tip is clogged or damaged. The contact tip size is too small.	Replace contact tip.
	Worn guides or drive roll alignment.	Replace parts.
Low output or non-penetrating weld.	The welding current is too low.	Adjust welding parameters.
	Wrong type or size wire.	Use .030" (0.8mm) - .035" (0.9mm) wire.
	Poor ground connection or gun connection.	Reposition clamp and check cable to clamp connection. Check connection of ground cable, gun, and Wire Polarity Drive Lead.
	Wrong size or worn contact tip	Use .030" (0.8mm) or 0.035" (0.9mm) contact tip with the corresponding wire. Replace contact tip if worn.
	Input power too low.	Have a qualified electrician verify the voltage at your outlet. If the voltage is appropriate, verify that the circuit wiring is sufficient for the circuit breaker size.
	Stick out too long.	Decrease stick out (the amount the wire extends past the contact tip).
Work clamp, ground cable, and/or welding cable get hot.	Bad ground or loose ground connection.	Check the connection of the work clamp and gun to the machine. Check the connection of the MIG Gun. Check connection of the ground cable to the work clamp. Tighten cable connection to work clamp if needed. Ensure the contact between the work clamp and workpiece is good and on a clean, bare metal surface. Make sure the cable is not damaged.
Gun nozzle arcs to work surface.	Spatter or Slag build-up inside nozzle or nozzle is clogged.	Clean or replace nozzle as needed.
Wire burns back to contact tip.	Wire feed speed is set too low for voltage setting being used.	Increase wire feed speed (turn left knob clockwise).
	Stick-out too short.	Increase stick-out (the amount the wire extends past the contact tip).
	Wrong size contact tip.	Use correct size contact tip.
	Contact tip is clogged or damaged.	Replace contact tip.
	Burn back time setting is too long.	Reduce the burn back time setting.

TROUBLESHOOTING

TIG WELDING ISSUES

PROBLEM	POSSIBLE CAUSE	COURSE OF ACTION
Poor starting.	Poor work clamp connection.	Check and secure work connection.
	Start current is too low.	Increase Start current.
Black area along weld bead.	Oily or organic contamination on work	Clean work piece.
	Tungsten electrode may be contaminated.	Grind to clean electrode.
	Leaks in gas line or torch connection.	Check connection.
	Gas tank is near empty.	Replace the gas tank.
Unstable Arc.	Contaminated base metal.	Remove materials like paint, grease, oil, and dirt, including mill scale from base metal.
	Tungsten is contaminated.	Remove 25/64" of contaminated tungsten and re-grind the tungsten.
	Arc length too long.	Lower torch so that the tungsten is off of the work piece 5/64"-13/64"(2-5mm).
Arc wanders.	Tungsten incorrect or in poor condition.	Check that correct type of tungsten is being used. Remove tungsten 3/4" from the weld end and re-sharpen the tungsten.
	Insufficient gas shielding.	Check and set the gas flow between 20-30 CFH flow rate.
	Contaminated gas or leaks in gas line, torch, or connections.	Check gas line & connections.
	Poorly prepared tungsten.	Recommend tungsten grind angles range from 15 to 60 degrees based on the type of metal, joint design and penetration you desire. Standard is 30 degrees.
	Contaminated base metal.	Remove contaminating materials like paint, grease, oil, and dirt, including mill scale from base metal.
	Contaminated/Incorrect filler.	Check the filler wire and remove all grease, oil, or moisture from filler metal.

TROUBLESHOOTING

TIG WELDING ISSUES

PROBLEM	POSSIBLE CAUSE	COURSE OF ACTION
Lift TIG does not initiate an arc.	No gas, incorrect gas flow.	Check the gas is connected and cylinder valve open, check hoses, gas valve and torch are not restricted. Set the gas flow between 20-30 CFH flow rate.
	Poor work clamp connection.	Check & secure work clamp.
	Contaminated Tungsten.	Grind to clean Tungsten.
	Loose connection.	Check all connectors and tighten.
	Earth clamp not connected to work.	Connect the work clamp directly to the work piece wherever possible.
Tungsten burning away quickly.	Incorrect Gas/Inadequate gas flow.	Check the gas cylinder contains pure Argon gas and is connected and the torch gas valve is open. Set the gas flow between 20-30 CFH flow rate.
	Back cap not fitted correctly.	Make sure the torch back cap is fitted so that the o-ring is inside the torch body.
	Incorrect tungsten being used.	Check and change the tungsten type if necessary.
Contaminated tungsten.	Touching tungsten into the weld pool.	Keep tungsten from contacting weld puddle. Raise the torch so that the tungsten is off of the work piece 1/8-1/4.
	Touching the filler wire to the tungsten.	Keep the filler wire from touching the tungsten during welding, feed the filler wire into the leading edge of the weld pool in front of the tungsten.
	Tungsten melting into the weld pool.	Check that correct type of tungsten is being used. Too much current for the tungsten size so reduce the amps or change to a larger tungsten.

TROUBLESHOOTING

STICK WELDING ISSUES

PROBLEM	POSSIBLE CAUSE	COURSE OF ACTION
Poor starting.	Poor work clamp connection.	Check and secure work connection
Stick electrode "blasts off" when arc is struck.	Current may be set too high for electrode size.	Adjust current.
Electrode "stick" in weld puddle.	Current may be set too low for electrode size.	Adjust current.
Porosity – small cavities or holes resulting from gas pockets in weld metal.	Arc length too long.	Reduce arc length.
	Damp electrode.	Use dry electrode.
	Workpiece dirty.	Remove all grease, oil, moisture, rust, paint, coatings, slag, and dirt from work surface before welding.
Excessive Spatter – scattering of molten metal particles that cool to solid form near weld bead.	Amperage too high for electrode.	Decrease amperage or select larger electrode.
	Arc length too long or voltage too high.	Reduce arc length or voltage.
Incomplete Fusion – failure of weld metal to fuse completely with base metal or a preceding weld bead.	Insufficient heat input.	Increase amperage. Select larger electrode and increase amperage.
	Improper welding technique.	Place stringer bead in proper location at joint during welding.
		changed the word "work" to "electrode" to help better explain angle when welding various positions.
		Momentarily hold arc on groove side walls when using weaving technique.
	Keep arc on leading edge of weld puddle.	
Workpiece dirty.	Remove all grease, oil, moisture, rust, paint, coatings, slag, and dirt from work surface before welding.	
Lack Of Penetration – shallow fusion between weld metal and base metal.	Improper joint preparation.	Material too thick. Joint preparation and design must provide access to bottom of groove.
	Improper weld technique.	Keep arc on leading edge of weld puddle.
	Insufficient heat input.	Increase amperage. Select larger electrode and increase amperage.
Reduce travel speed.		
Burn Through – weld metal melting completely through base metal resulting in holes where no metal remains.	Excessive heat input.	Select lower amperage. Use smaller electrode.
		Increase or maintain steady travel speed.

CODE OF OPERATION AND ERROR

CODE			CODE			CODE		
V	U	VOLTAGE(V)	PoG	pog	POST-GAS	r in	rin	FEEDER SPEED (ARC START/INCHING)
A	I	CURRENT(A)	Gas	gas	GAS-CHECKING	HS	HS	HOT START CURRENT
Spt	spt	SPOT TIME	Syn	syn	SYNERGIC MIG SETTING	Frq	frq	FREQUENCY
Cur	cur	CURRENT ADJUSTMENT	FEd	fed	INCHING	duY	DUY	DUTY CYCLE
ind	ind	INDUCTOR	hS	hs	ARC START CURRENT	VRd	VRD	ANTI-ELECTRIC SHOCK FUNCTION
ArL	arl	ARC LENGTH (SYN MODE)	bbt	bbt	END ARC CURRENT	on	ON	
dP	DP	DOUBLE PULSED	dIG	dig	ARC FORCE	oFF	OFF	
Prg	prg	PRE-GAS	Ant	Ant	ANTI-STICK			

WIRING DIAGRAM

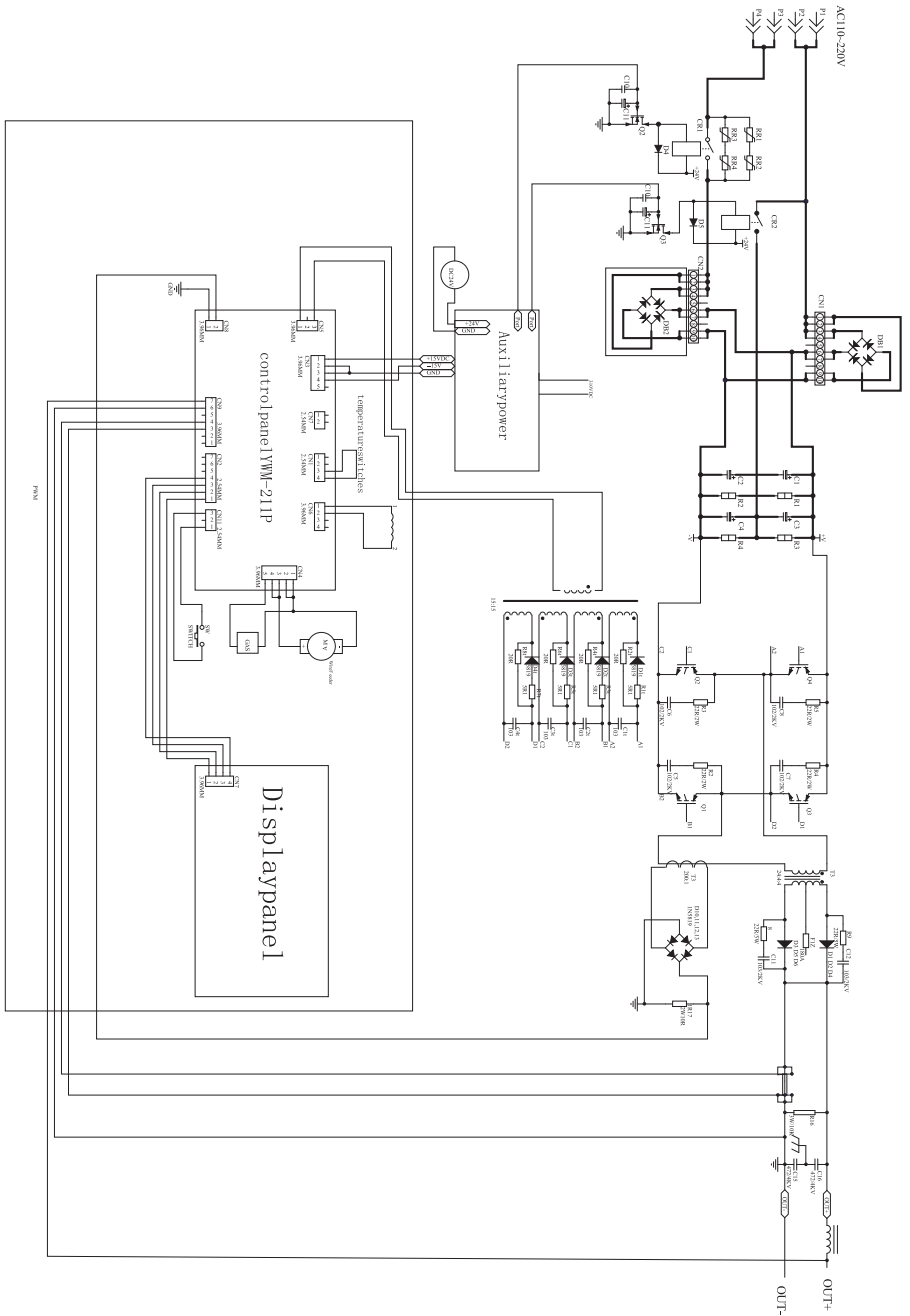

YESWELDER[®]
www.yeswelder.com

WE ALWAYS STAND BEHIND IT

Toll Free (855) 937-4567