

modwave

WAVETABLE SYNTHESIZER

Owner's Manual

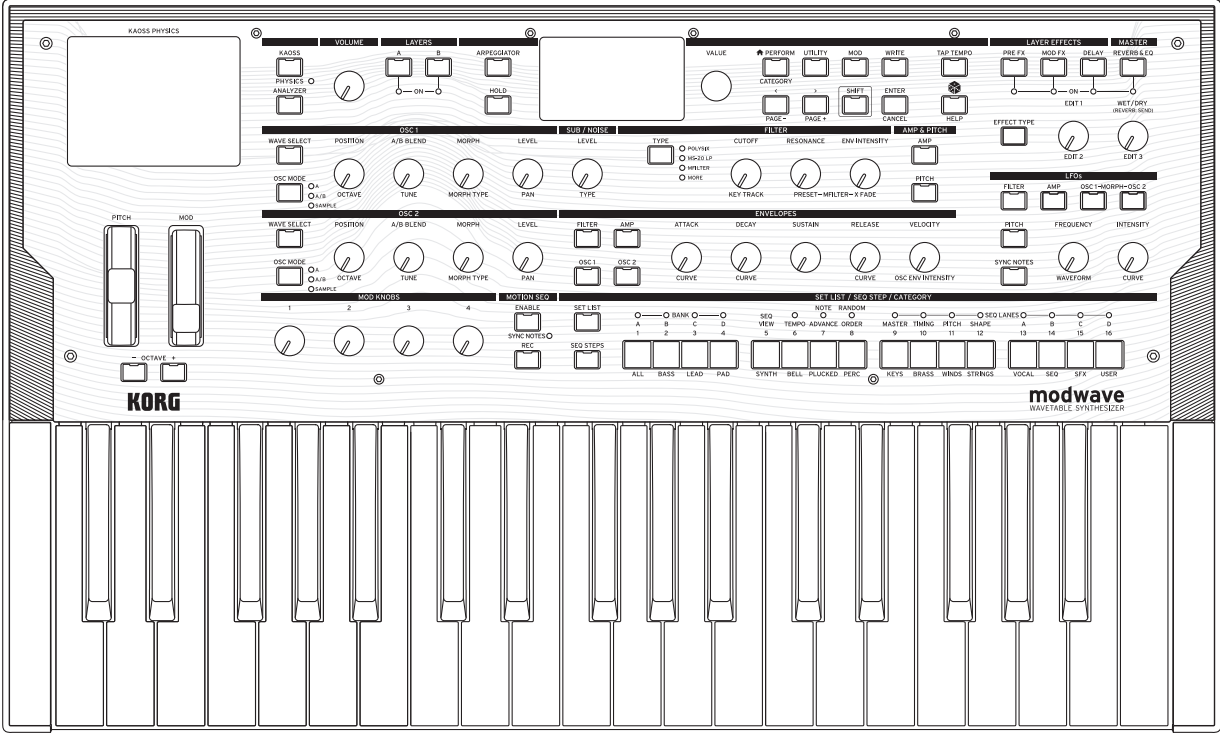

KORG

Contents

- Getting Started** **1**
- About the modwave manuals 1
- If you don't usually read manuals... 1
 - Navigation..... 1
 - SHIFT** **2**
 - ENTER** for accelerated editing..... 2
 - Modulation 2
 - Mod Knobs 2
 - Help pages 3
 - Structure 3
- Selecting and Playing Sounds** **4**
- Selecting Sounds 4
 - Selecting Performances from the display 4
 - Selecting from lists..... 4
- Using Set Lists 5
 - Assigning a Performance to a Set List Slot..... 6
- Basic Editing** **7**
- Home Page (PERFORM) 7
- Layer Programs..... 7
- Velocity Zones..... 8
- Keyboard Zones 8
- Program Setup 9
- Voice Assign..... 10
- Layer Setup..... 12
- Performance Setup 13
- Write** **14**
- Saving Sounds..... 14
- Name 14
 - Editing names 15
- Write Metadata 15
- Compare 15
 - Using Compare 16
- Delete from Database..... 16
 - Using Delete..... 16
- Wavetable Osc.** **17**
- Overview 17
- Osc 1 Waveform 17
 - Modes A and A/B 17
 - Sample Mode..... 19
- Osc 1/2 Position 20
- Osc 1/2 Morph..... 21
- Osc 1/2 Details..... 23
- Mixer & Sub Osc 24
 - Osc 1 24
 - Osc 2 24
 - Sub/Noise 24
- Analyzer** **26**
- Motion Sequencing 2.0** **27**
- What is Motion Sequencing 2.0? 27
- Motion Seq Overview 28
- Motion Sequence Recording 29
 - Step recording Pitch 29
 - Real-time recording for Seq Lanes A-D..... 29
- Motion Sequence editing 31
 - Editing Lanes 31
 - Editing Steps 31
 - Step Solo mode..... 31
- Motion Sequencer 32
- Master Lane 33
- Standard Lane Controls 34

Contents

Step Probability	35
Timing Lane probability	35
Timing	35
Timing Lane	35
Timing Lane Step	37
Pitch	38
Pitch Lane	38
Pitch Lane Step	40
Shape	41
Shape Lane	41
Shape Lane Step	41
Seq A/B/C/D	42
Seq Lane	42
Seq Lane Step	43
Motion Sequence Utility	44
Cut Steps, Copy Steps, Paste Steps, Insert Steps	44
Clear	44
Scale Timing	44
Kaoss Physics	45
Overview	45
Using Kaoss Physics to create specific results	45
Kaoss Physics and MIDI	45
Kaoss Physics	46
Kaoss Physics Details	47
Kaoss Launch	48
Arpeggiator	49
Arpeggiator	49
Filter	51
Filter	51
2-Pole LP/HP/BP/BR	53
4-Pole LP/HP/BP/BR	53
MS-20 LP/HP and Polysix	53
Multi Filter	54
Multi Filter	54
What's a Multi Filter?	55
Manual	55
Filter Mod	55
Filter Key Track	57
How Key Track works: Keys and Slopes	57
Pitch	59
Osc Pitch	59
Osc 1	59
Osc 2	59
Common Pitch	60
Pitch Mod	61
Amp	62
Amp	62
Amp Key Track	63
Modulation	64
Using Modulation	64
Modulation Overview	64
Adding Modulation Routings	64
Viewing and Editing Modulations	65
Mod Knobs	67
Modulation Sources	67
Controllers	67
Mod Knobs	69
Generators	69
CC +	69
CC +/-	69
Envelopes	70
Filter/Amp/Osc 1/Osc 2 Envelope	70
Filter/Amp/Osc 1/Osc 2 Envelope Curve	70

Contents

Filter/Amp/Osc 1/Osc 2 Envelope Trigger	71
LFOs	73
Filter/Amp/Pitch/Osc 1/Osc 2 LFO	73
Modulation Processors	76
Overview	76
Gate	76
Offset	77
Quantize	78
Scale	79
Curve	79
Smooth	81
Sum	81
Effects	83
Overview	83
Main page	83
Level controls	84
Edit page	84
Pre FX	85
Decimator	85
Graphic EQ	85
Guitar Amp	85
Modern Compressor	85
Parametric EQ	85
Red Compressor	85
Ring Modulator	85
Tremolo	85
Wave Shaper	85
Mod FX	86
Black Chorus/Flanger	86
Black Phase	86
CX-3 Vibrato Chorus	86
EP Chorus	86
Harmonic Chorus	86
Modern Chorus	86
Modern Phaser	86
Orange Phase	86
Polysix Ensemble	86
Small Phase	86
Talking Modulator	86
Vintage Chorus	86
Vintage Flanger	87
Vintage/Custom Wah	87
Vox Wah	87
Delay	87
L/C/R Delay	87
Multiband Mod Delay	87
Reverse Delay	87
Stereo/Cross Delay	87
Tape Echo	87
Master Reverb	87
Early Reflections	88
Overb	88
Master EQ	88
L (Low) and H (High)	88
Mid 1 and Mid 2	88
Randomize	89
Using Randomize	89
Utility	90
System Setup	90
MIDI & USB	91
Controllers	92
MIDI CC Assign	94
Global Scale	94

Contents

Preferences.....	95
System Stats.....	96
About.....	96
USB.....	97
MIDI.....	97
Editor Librarian.....	97
Specifications.....	98
MIDI Implementation Chart.....	99

Getting Started

Thank you for purchasing the Korg modwave Wavetable Synthesizer.

About the modwave manuals

The documentation for the modwave consists of the following:

- Precautions
- Quick Start Guide
- Owner’s Manual (what you’re reading now)

In this manual, the following text styles indicate:

- **FRONT PANEL CONTROLS**
- **Parameter Names**
- *Parameter Values*

If you don’t usually read manuals...

Even if you don’t usually read manuals, please read this section!

Navigation

Press a button or turn a knob, and the display will show the related page. See “Modwave page map” on page 2 for all of the pages in the UI and their associated front-panel controls.

Some pages, such as Mixer & Sub Osc, are only displayed by turning a knob. Similarly, the **ARPEGGIATOR** button both edits a parameter and displays a page. To display these or any other pages without making an edit, hold **ENTER** and turn or press the related knob or button. The page will appear with the parameter selected, but the value will not be changed.

To go back to selecting sounds, press **PERFORM**. If you don’t see the main page the first time, press **PERFORM** again; two presses will always bring you to the home page with the Performance name selected.

< > and **PAGE-/PAGE+** are the basic controls for moving around in the display.

< and **>** cursor through parameters, and can also select items in lists.

Hold **SHIFT** and press **<** or **>** to use **PAGE-** and **PAGE+**, which select pages in the display. There are page indicators in the upper right of the display; the filled-in circle shows the current page.

Title bar with selected Layer, Page Name, and Page Indicators

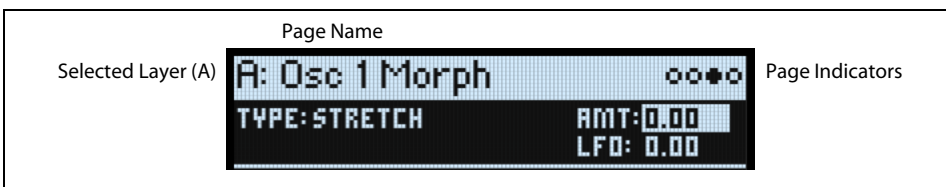

LAYER A/B: Layers contain a Program, an Arpeggiator, and a handful of other settings. The front panel edits one Layer at a time, as selected by these buttons. To turn a Layer on or off, hold **SHIFT** and press the Layer’s button, or just double-press the button.

Most pages on the display apply only to the selected Layer. For these pages, the Layer’s letter (A/B) is shown in the upper left of the display.

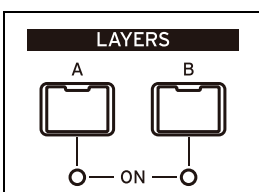

Getting Started

Modwave page map

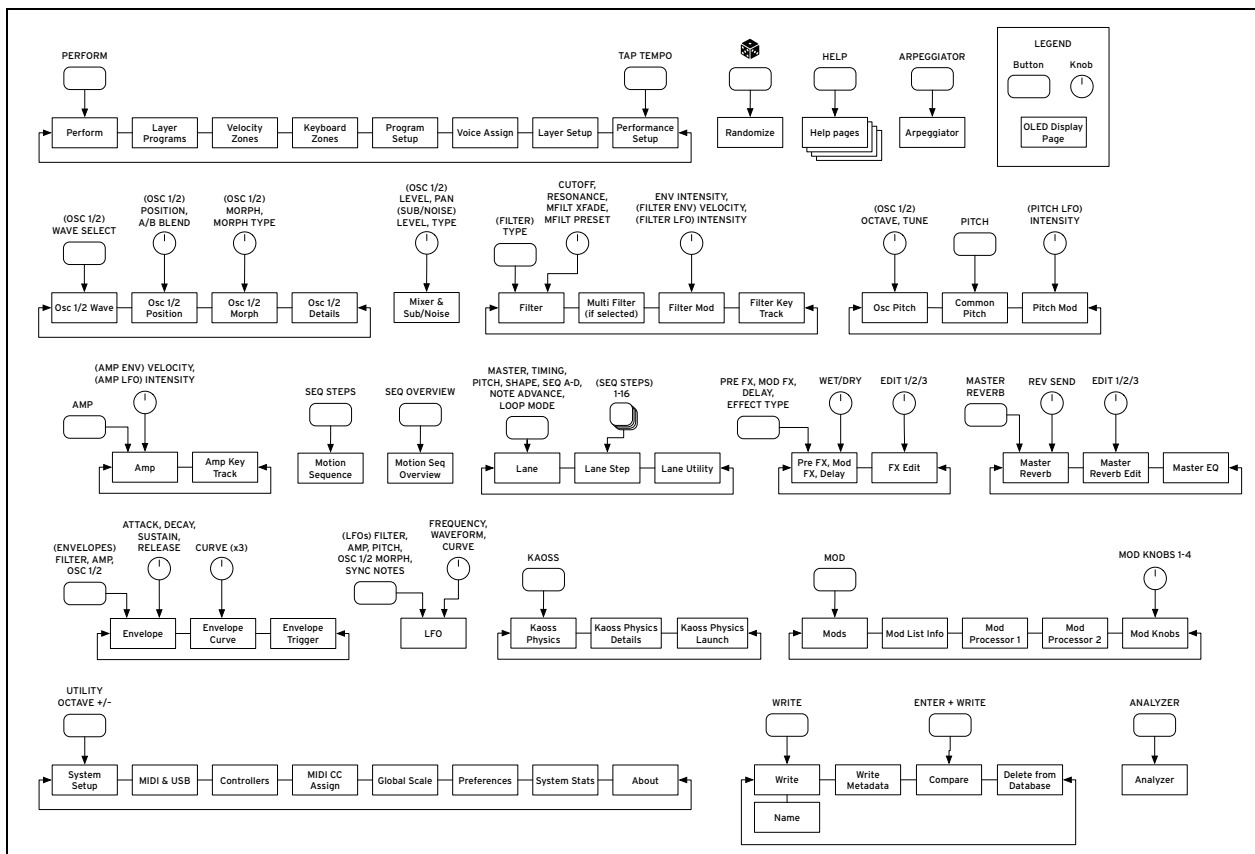

SHIFT

Hold down **SHIFT** to use alternative functions for knobs and buttons, labeled in blue text. For one-handed operation, double-press **SHIFT** to turn on Shift Hold; press again to turn off.

ENTER for accelerated editing

Hold down **ENTER** to accelerate editing or scrolling. For example:

- Normally, the **VALUE** knob works as a “fine” value input when moved slowly, with “coarse” bigger jumps when moved quickly. To restrict it to “coarse” value changes, hold **ENTER** while turning **VALUE**.
- Hold **ENTER** and press **<** or **>** (or turn the **VALUE** dial) to scroll by a whole page in a list, such as when selecting Performances, Multisamples, or Mod routings.

Modulation

Most front-panel knobs and on-screen parameters are modulatable. Hold **MOD** and press **>** to create a new modulation routing. When viewing and editing modulations, hold **MOD** and press **<** to filter the list. See the Mod List Info page for an on-screen list of shortcuts.

Mod Knobs

You can use the Mod Knobs in real-time performance, and also save the results as new sounds. The names are shown on the main PERFORM screen. The values are stored, and can themselves be modulated. The Mod Knobs can control any number of parameters in any of the Layers.

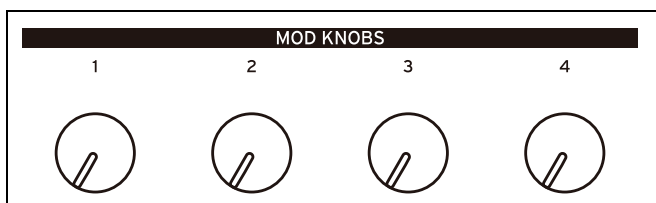

Getting Started

Help pages

Hold **SHIFT** and press the  (Randomize) button to bring up a set of pages containing shortcuts and usage tips.

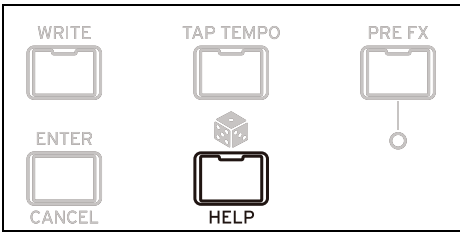

Structure

The modwave plays one Performance at a time.

A Performance has two Layers (A and B), Kaoss Physics, and a master reverb and EQ.

Each Layer contains an Arpeggiator, a Program, and other settings such as MIDI channel, key and velocity zones, etc.

A Program includes two Oscillators (1 and 2), each of which may play one or two Wavetables (A and B) or a single Multisample, a Sub Oscillator/Noise Generator, a Filter, an Amp, a Motion Sequence, a set of modulators, a modulation matrix, and three effects: Pre FX, Mod FX, and Delay.

Modwave structure

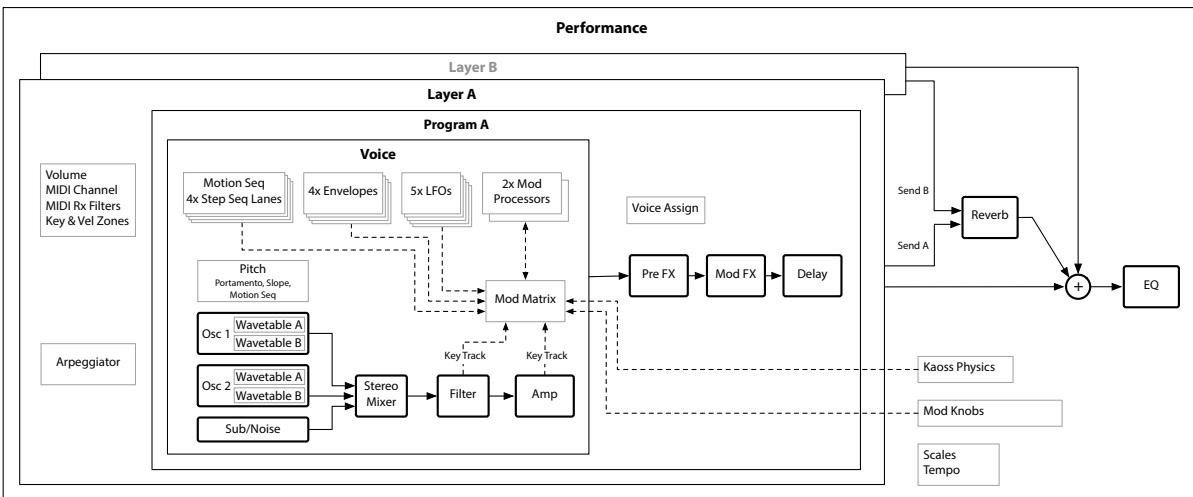

Selecting and Playing Sounds

Selecting Sounds

Selecting Performances from the display

1. Press the **PERFORM** button, and if necessary press it again.

Wherever you are in the system, the second press will always bring up the home page, with the large Performance name selected.

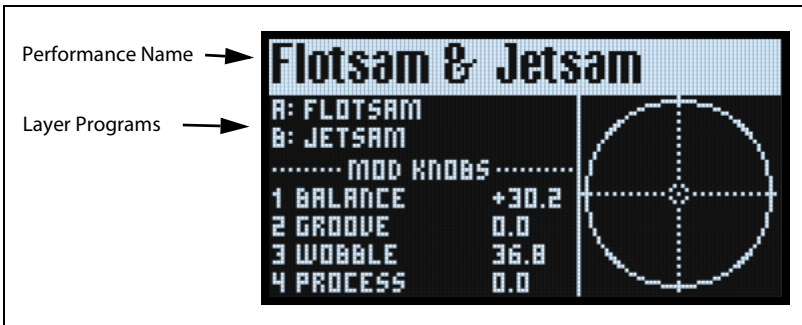

2. Follow the instructions under “Selecting from lists,” below.

Selecting from lists

Note: These instructions also apply to selecting Set Lists, Performances, Programs, Effects Presets, Motion Sequences, Wavetables, Multisamples, and Lane Presets.

1. **Cursor to the item that you’d like to select.**

For this example, we’ll use Performances, continuing from above.

2. **Turn the VALUE knob or press ENTER.**

A popup appears, showing a list of sounds.

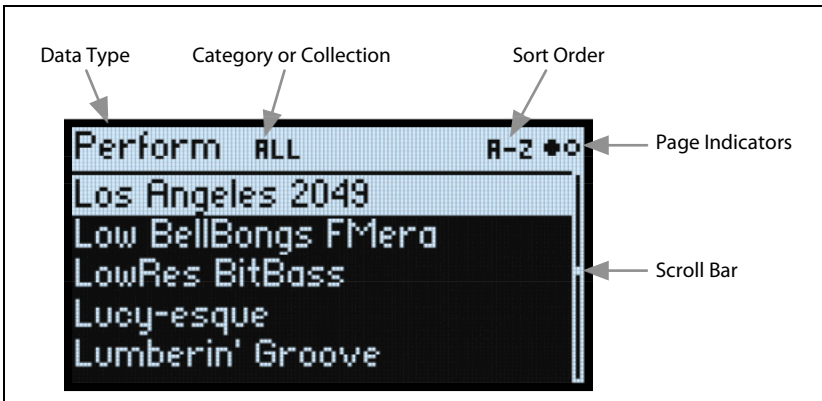

3. **Turn the VALUE knob or use < and > to select sounds. Hold ENTER and press < or > to jump by 5.**

You can play the sounds as you scroll through the list.

4. **When you find a sound that you like, press ENTER again (or SHIFT-ENTER to cancel).**

Using Categories

You can filter the list by category or collection. To do so:

1. **While the list is onscreen, press CATEGORY buttons 2 (BASS) to 16 (USER) to show only a specific category of sounds.**
2. **To show all sounds again, press button 1 (ALL).**

The category names on the front panel apply to Performances, Programs, and Multisamples; for all other types of data (Wavetables, Motion Sequences, etc.), the buttons select the first 15 Categories in the list.

Selecting and Playing Sounds

You can also show the list of categories on the display. To do so:

1. In the list popup, hold **SHIFT** and press **>** (for **PAGE+**).

The Filters & Sort Order page appears.



2. Select the **Category** or **Collection** parameter, and turn the **VALUE** knob or press **ENTER**.

The Category or Collection Select popup appears. The lists will vary depending on the data type.

3. Select the desired **Category** or **Collection**, and press **ENTER**.

The display returns to the Performance Select popup, showing only sounds in the selected Category or Collection.

Using Sort Order

You can change the order in which sounds appear in the list. To do so:

1. In the list popup, press **PAGE+**.

The Filters & Sort Order page appears.

2. Select **Sort Order**, and turn the **VALUE** knob or press **ENTER**.

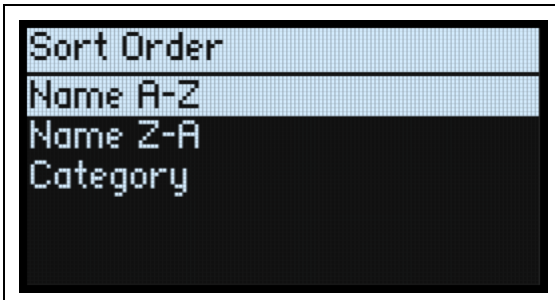

3. Choose the desired order.

You can choose from alphabetical (A-Z), reverse alphabetical (Z-A), or Category (sorted alphabetically within each Category).

Using Set Lists

Set Lists let you group and order Performances for gigs or projects. A Set List has 64 Slots, arranged into four banks A-D, corresponding to MIDI Program Change messages 1-64.

 **Important:** Set Lists don't contain separate copies of their sounds; they just point to Performances stored in the database.

To select sounds in the current Set List:

1. Press the **SET LIST** button, so that it is lit.
2. To select sounds in the current bank, press buttons 1-16.
3. To select from a different bank, first hold either **SHIFT** or **SET LIST** and then press 1/2/3/4 to select the bank. Buttons 1-16 will then blink; press one to select a sound in the new bank.

Selecting and Playing Sounds

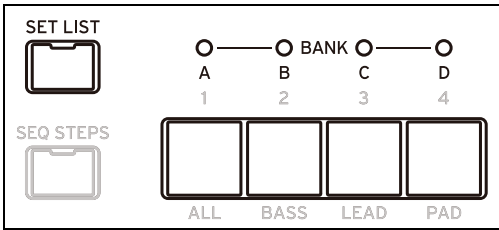

If you select a sound using the display, buttons **1-16** will go dark. To return to the Set List, just press one of the buttons again.

You can store many different Set Lists, and switch between them as desired. To select a different Set List:

1. Press **UTILITY** twice, to go to the System Setup page.

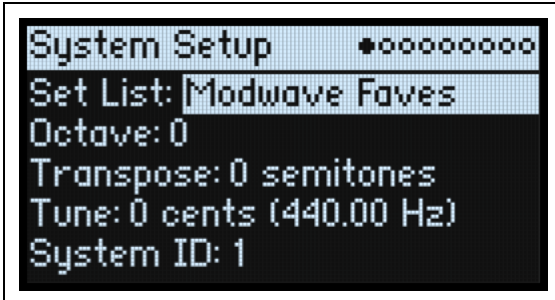

2. Select the Set List parameter, and press **ENTER** or turn the **VALUE** knob.

From this point, selecting Set Lists works just like selecting Performances, as described above.

Assigning a Performance to a Set List Slot

1. Select the Performance that you'd like to assign.
2. Press the **SET LIST** button, so that it is lit.
3. Hold **WRITE** and press the Slot to which you'd like to save.

The Write page appears, with that Slot already selected. To change the Slot, hold **WRITE** and press a different Slot button.

4. Press **WRITE**, and then **ENTER** to confirm.

The Set List will also be saved. If the Performance has been edited, you'll be prompted to save it too.

Assigning to a Slot in a different bank

While you're on the Write page, you can also select a Slot from a different bank (for instance, if you're copying a Performance to a different Slot):

1. Hold **WRITE** and **SHIFT** (or, if you prefer, **WRITE** and **SET LIST**), and press button **1-4** for the desired Bank.
2. Release **WRITE** and **SHIFT**.
3. Proceed to Step 3 above.

Basic Editing

Home Page (PERFORM)

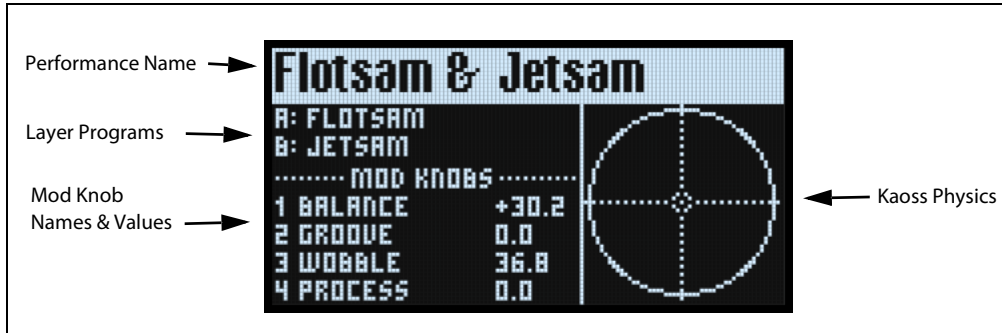

This is the modwave's main page, where you can select Performances, set the Programs for the two Layers, see the Mod Knob names and values, and view the Kaoss Physics graphic.

Wherever you are in the system, pressing **PERFORM** twice in row always returns here, with the Performance name selected.

Normally, using Mod Knobs takes you to the related pages in the display. The home page is an exception, so that you can use the Mod Knobs while browsing through Performances.

The home page is also the only one on which the Page Indicators do not appear. Press **PAGE+** to go to the Layer Programs page.

KAOSS Physics display

This shows the Kaoss Physics environment, which models a ball rolling on a surface. You can start the ball by flicking a finger on the x-y pad, or launch the ball automatically using a trigger source. You can also directly control the ball by holding your finger on the pad. The position of the ball produces several modulation signals, which can control any modulatable parameters. For more information, see “Kaoss Physics” on page 45.

Layer Programs

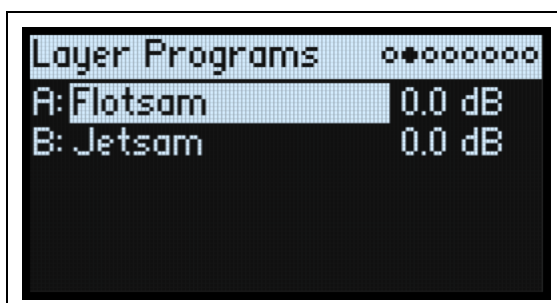

This page shows the Program selection and Volume for each Layer.

A, B (Programs A, B)

[List of Programs]

This selects the Program for the Layer.

(Volume A, B)

[-Inf, -84.9...+6.0 dB]

This controls the volume of the Layer (duplicating the Layer Setup page's **Volume** parameter). This is saved in the Performance, instead of the Program—so it's a good choice when balancing levels between Layers.

Velocity Zones

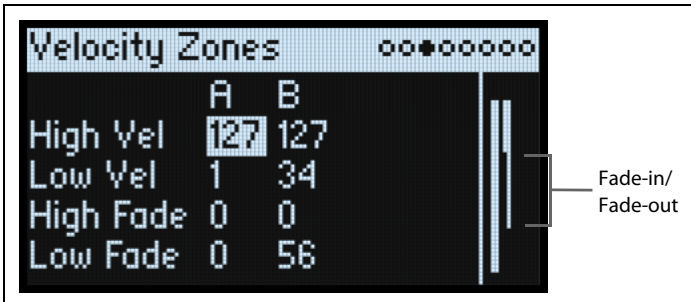

Shortcut: Pressing a **LAYER** button switches to the current parameter in the selected Layer's column.

High Vel (A, B), Low Vel (A, B)

[1...127]

These set the highest and lowest velocities on which the Layer will sound.

High Fade (A, B)

[0...126]

0: The **High Vel** acts as a hard split, with full volume on one side and silence on the other.

1...126: This lets you create a velocity crossfade. As velocity approaches the **High Vel**, the volume fades out gradually.

High Fade sets the velocity range over which the fade-out occurs, working inwards from the **High Vel**.

Low Fade (A, B)

See "High Fade (A, B)," above.

Setting values from the keyboard

You can set velocities and note numbers directly from the keyboard, or via MIDI. This applies throughout the modwave. To do so:

1. Select the velocity or note number parameter you'd like to edit.
2. Press and hold the **ENTER** button.
3. Play a note on the keyboard to set the parameter.
4. Release the **ENTER** button.

Keyboard Zones

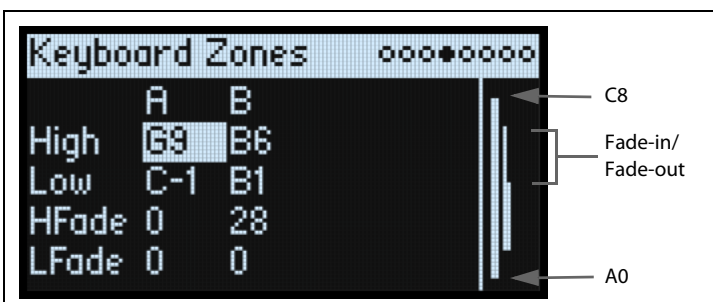

Shortcut: Pressing a **LAYER** button switches to the current parameter in the selected Layer's column.

High (A, B), Low (A, B)

[C-1...G9]

These set the highest and lowest notes on which the Layer will sound.

Note: The graphic shows only the standard range of 88 notes.

HFade (High Fade A, B)

[0...127]

0: The **High** key acts as a hard split, with full volume on one side and silence on the other.

1...127: This allows you to create a keyboard crossfade. As the notes approach the **High** key, the volume will fade out gradually. This sets the number of semitones over which the fade-out occurs, working inwards from the **High** key.

LFade (Low Fade A, B)

[0...127]

See “HFade (High Fade A, B),” above.

Program Setup

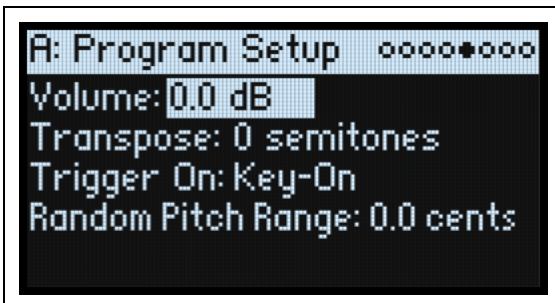

The settings on this page are stored with the Program, if the Program is written separately.

Volume

[*-Inf, -84.9...0.0 dB*]

This controls the overall volume of the Program. Unlike Layer Volume, it's stored with the Program. Use this to balance the Program's default volume with respect to other Programs.

Transpose

[*-60...+60 semitones*]

This transposes the Program by up to 5 octaves, up or down, in semitones.

Trigger On

[*Key-On, Key-Off*]

Key-On: This is the default setting, in which the Program is played when a key is pressed.

Key-Off: The Program will play as soon as you release the key. You can use this to create the “click” heard when a harpsichord note is released, for instance. In general, when using *Key-Off* it's also best to set the Amp Envelope **Sustain** to 0.

Random Pitch Range

[*0.0...50.0 cents*]

This parameter creates random variations in pitch for each note. At the default of 0.0, pitch will be completely stable; higher values create more randomization. This can be helpful for simulating instruments that have natural pitch instabilities, such as analog synths, tape-loop keyboards, or acoustic instruments.

Voice Assign

Mode = Poly

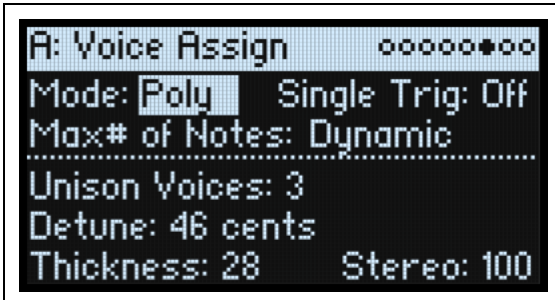

The settings on this page are stored with the Program, if the Program is written separately.

(Voice Assign) Mode

[Poly, Mono]

This selects the basic voice allocation mode. Depending on which one you select, various other options will appear, such as **Single Trig** (*Poly* mode only) and **Unison** (*Mono* mode only).

Poly: The Program will play polyphonically, allowing you play chords.

Mono: The Program will play monophonically, producing only one note at a time.

Single Trigger

[Off, On]

Single Trigger is available when **Voice Assign Mode** is set to *Poly*.

On: When you play the same note repeatedly, the previous note will be silenced before the next note is sounded, so that the two do not overlap.

Off: When you play the same note repeatedly, the notes will overlap.

Max # of Notes

[Dynamic, 1...32]

Max # of Notes is available when **Voice Assign Mode** is set to *Poly*.

Dynamic is the default. With this setting, you can play as many notes as the system allows.

1-32 limits the number of notes played by the Program. Voices will be allocated dynamically up to this maximum. You can use this to:

- Model the voice-leading of vintage synthesizers
- Control the resources required by individual Programs

This setting does not limit the **Unison Voices** parameter. For instance, if **Max # of Notes** is set to 6, and **Unison Voices** is set to 3, you can play up to 6 notes, each with 3 Unison voices.

Mode = Mono



Mono Legato

[Off, On]

Mono Legato is available when **Voice Assign Mode** is set to *Mono*.

Legato means to play in a smooth, connected way; the next note is played before the last note is released.

Basic Editing

On: The first note in a legato phrase will sound normally; subsequent notes in the phrase will sound smoother (for instance, envelopes will continue instead of restarting).

Off: Legato playing will produce the same sound as detached playing.

Priority

[Low, High, Last]

Priority is available when Voice Assign Mode is set to *Mono*.

This determines what happens when more than one note is being held down.

Low: The lowest note will sound. Many vintage monophonic analog synths work this way.

High: The highest note will sound.

Last: The most recently played note will sound.

Unison Voices

[1...16]

Unison can be used in both Mono and Poly modes.

1: Unison is off, and **Stereo Spread** and **Detune** do not apply.

2-16: The Program uses the specified number of more stacked, detuned voices to create a thicker sound.

Detune

[0...200 cents]

This parameter sets the tuning spread for the **Unison** voices.

Voices = 3, Detune = 24, Thickness Off

Voices	Detune
1	-12
2	0
3	+12

Voices = 4, Detune = 24, Thickness Off

Voices	Detune
1	-12
2	-4
3	+4
4	+12

Thickness

[0...100]

This parameter controls the character of the detuning for the unison voices.

0: Unison voices are evenly distributed across the **Detune** range, as shown above.

1...100: Unison voices are detuned asymmetrically. This makes the detuning more complex, and changes the way in which the pitches beat against one another—like slightly out-of-tune oscillators in a vintage synthesizer. Higher numbers increase the effect.

Stereo (Spread)

[0...100]

Stereo lets you create a wider stereo field when using **Unison**. It applies only when **Unison Voices** is 2 or greater.

Layer Setup

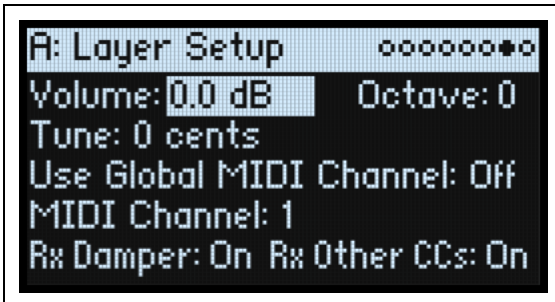

Volume

[-Inf, -84.9...+6.0 dB]

This controls the volume of the Layer. Note that this is saved in the Performance, but not with the Program—so it's a good choice when balancing levels between Layers.

Octave

[-3...+3]

This transposes the Layer by up to 3 octaves, up or down.

Tune

[-100...+100 cents]

This lets you detune the Layer by up to 100 cents (1/100 of a semitone), up or down.

Use Global MIDI Channel

[Off, On]

On: This is the default. The Layer will play from the built-in keyboard, and receive on the **Global Channel**.

Off: The Layer will receive on the channel specified below, and will not play from the built-in keyboard.

MIDI Channel

[1...16]

This is shown only if **Use Global MIDI Channel** is *Off*. It sets the channel on which the Layer will receive MIDI.

Rx Damper

[Off, On]

On: This is the default. The Layer will respond to the connected damper pedal and to MIDI CC#64.

Off: The Layer will ignore both the connected damper pedal and MIDI CC#64.

Rx Other CCs

[Off, On]

On: This is the default. The Layer will respond normally to MIDI CCs.

Off: The Layer will ignore all MIDI CCs (except for CC#64), as well as Aftertouch, Poly Aftertouch, and Pitch Bend.

Performance Setup

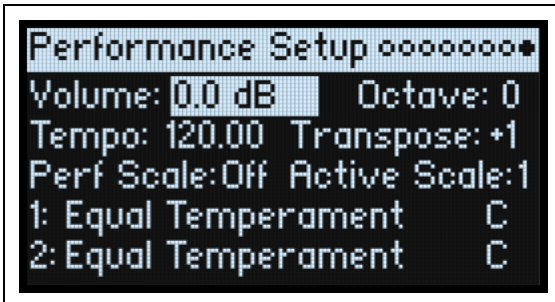

Volume

[-Inf, -84.9...0.0 dB]

This controls the Performance volume, for balancing levels with other sounds.

Octave

[-2...+2]

This transposes the entire Performance by up to 2 octaves, up or down.

Tempo (TAP TEMPO)

[40...300]

This sets the tempo for the Performance.

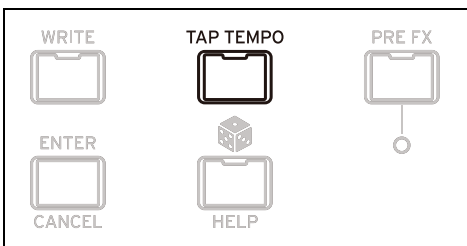

Transpose

[-12...+12]

This transposes the entire Performance by up to 12 semitones, up or down.

Perf Scale

[Off, On]

On: The Performance Scale settings, below, are used—unless **Global Scale** is *On*, in which case the Global scales are used instead.

Off: The Performance Scale settings are ignored.

Active Scale, 1 (Scale 1), (Key), 2 (Scale 2), (Key)

For details on the scale parameters, see “Global Scale” on page 94.

Write

Saving Sounds

The Performance, with its two Layers, contains a complete modwave sound. When selecting, editing, and saving sounds, Performance are all you need to use. While you can save Programs and presets for Motion Sequences, Motion Sequence Lanes, and Kaoss Physics, you don't have to do so: all data is contained in the Performance.

Similarly, when you load any of these other data types into a Performance, a new copy of the data is created in the Performance. Any edits affect only the local copy inside the Performance, and not the original data. This lets you edit freely without worrying about changing other sounds.

To save:

1. Press the **WRITE** button.

The Write page appears, with the type of data to write shown at the top of the page. By default, this is set to *Performance*.

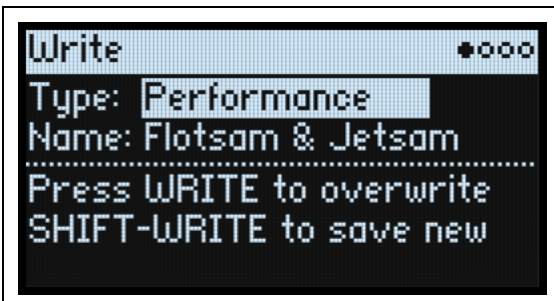

2. To choose a different data type, hold **WRITE** and press a button such as **LAYER A/B** or **SEQ STEPS**, or set the Type manually in the display.
3. Optionally, edit the name and/or Categories before proceeding.

For more details, see “Editing names” on page 15 and “Write Metadata” on page 15.

Important: changing the name does not automatically make a new copy of the sound!

4. To overwrite the existing sound, press **WRITE**. To make a new copy and leave the existing sound unchanged, press **SHIFT-WRITE**.
5. Press **ENTER** to confirm, or **SHIFT-ENTER** to cancel.

Factory sounds may be write-protected, in which case only “save new” is available.

Warning: Never turn off the power while data is being saved. Doing so may destroy the internal data.

Name

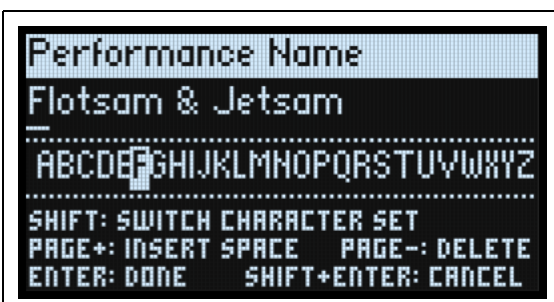

Note: you can name Programs, Motion Sequences, Lanes, and Kaoss Physics Presets without writing them separately. As long as you save the enclosing Performance, the new name will be saved.

Editing names

1. On the Write page, select the Name.
2. Press **ENTER**, or turn the **VALUE** dial.

The Name page appears.

3. Use the cursor buttons to move back and forth in the text, and use **VALUE** to select a character from the set shown below.

Names can be up to 24 characters long.

4. Press **SHIFT** to toggle between A-Z, a-z, numbers, and symbols.
5. Hold **SHIFT** and press > (**PAGE+**) to insert a space.
6. Hold **SHIFT** and press < (**PAGE-**) to delete the previous character.
7. When you've finished entering text, press **ENTER** to return to the previous page, or **SHIFT-ENTER** to cancel.

Write Metadata

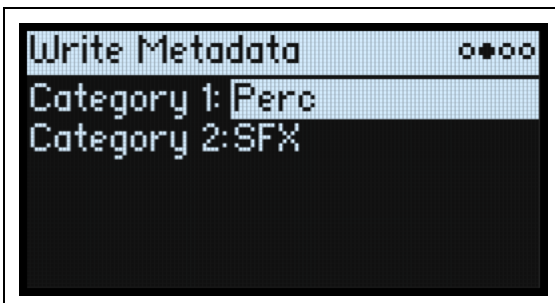

This shows the Categories for the item shown on the Write page.

Note: When **Type** is set to *Set List Slot*, this page is not available.

Category 1/2

[List of Categories]

Each object type—Performances, Programs, etc.—has its own list of Categories. You can create new Categories using the Editor Librarian software, if desired. Note that only the first 15 Categories are mapped to the front-panel buttons.

Compare

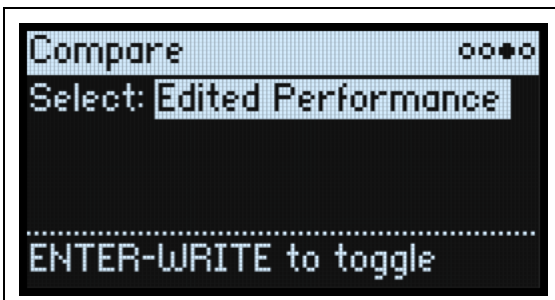

Select

[Saved Performance, Edited Performance]

Saved Performance: The saved version of the Performance will be heard.

Edited Performance: The edited version of the Performance will be heard. If the Performance has not been edited, this is not available.

Using Compare

To use compare:

1. Hold **ENTER** and press **WRITE**.

The Compare page will appear.

2. Hold **ENTER** and press **WRITE**, again, to toggle between the saved and edited versions of the Performance.

When you change from *Edited Performance* to *Saved Performance*, the edited version is stored in a buffer, and the Performance reverts to the version saved in the database. You can toggle back and forth between the two as many times as you like.

- ⚠ If you change to *Saved Performance* and then make any edits, the next time you go to the Compare page **Select** will be set to *Edited Performance*, and the previously buffered “Edited Performance” will be lost.

Delete from Database

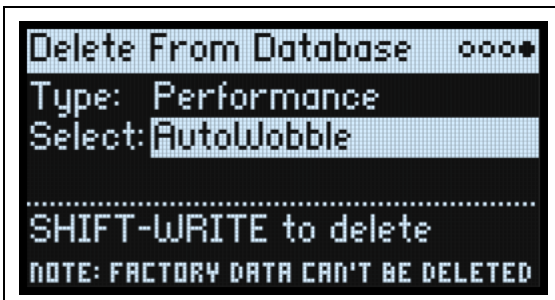

This page lets you delete user-created items from the database.

- ⚠ **Note:** Factory data cannot be deleted.

Using Delete

To delete an item from the database:

1. Set the **Type** as desired.
2. Cursor to **Select**, and press **ENTER**.

The selection popup appears.

3. Select a user-created item from the list. Optionally, use **PAGE+** to change the filters or sort order.
4. Press **ENTER** to confirm the selection and close the popup.
5. Hold **SHIFT** and press **WRITE** to delete the selected item.

A confirmation dialog will appear.

6. Press **ENTER** to confirm, or any other key to cancel.

Wavetable Osc

Overview

Osc 1 and Osc 2 can each play either a single Wavetable, a modulatable blend of two Wavetables, or a Multisample. The modwave ships with over 200 Wavetables, and you can also import your own via the Sound Librarian software. The sound of the Wavetables can be changed in different ways. Wavetable Modifiers change the way that the tables are generated at load time, resulting in subtle to extreme changes in timbre. Morph Types change the way that the Wavetables are played, and can be modulated in real-time from Envelopes, LFOs, and so on.

Oscillator Mode (OSC MODE)

[A, A/B, Sample]

This three-way switch on the front panel controls the basic capabilities of the Oscillator.

A: The Oscillator will play a single Wavetable.

A/B: The Oscillator will play a blend of two Wavetables, A and B. **A/B BLEND** lets you control the balance between the two. Use this to combine characteristics of two different Wavetables (such as a pure-sounding table and a buzzy-sounding one), or the same Wavetable processed by two different **Wavetable Modifiers**.

Sample: The Oscillator will play a Multisample.

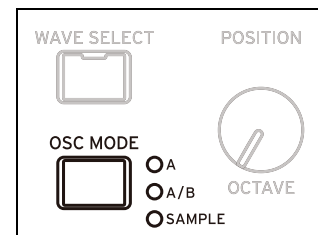

Osc 1 Waveform

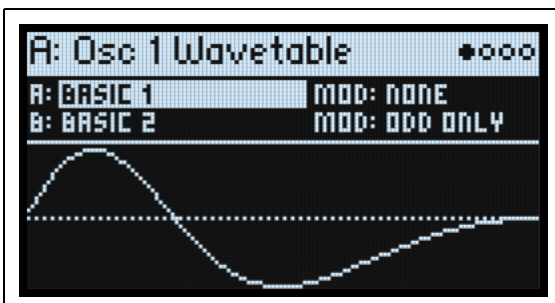

Modes A and A/B

A (Wavetable A) (WAVE SELECT)

[List of Wavetables]

This appears if **Oscillator Mode** is set to A or A/B. Select the parameter and then either turn the **VALUE** knob or press **ENTER** to bring up the Wavetable Select popup, which shows all of the Wavetables installed on the instrument. For details on sorting and filtering the list of Wavetables, see “Selecting from lists” on page 4.

Listening to the Wavetables

When auditioning Wavetables, play lower-pitched notes. The lower the pitch, the more clearly you’ll hear all of the high harmonics.

By default, the OSC 1 and OSC 2 Envelopes modulate **Position**; this sweeps the Wavetables for their respective oscillators. **Attack** sweeps forward in the Wavetable, and **Decay** sweeps backwards; the **Sustain** level determines the resting point. Try both fast and slow envelope times for both **Attack** and **Decay**—even 10 or more seconds may be useful for particularly complex Wavetables!

Adjust the amount of modulation using **Env Intensity (SHIFT-VELOCITY)**. Sometimes, you may want the intensity to be at its maximum; other times, especially with more complex Wavetables, much smaller amounts of modulation may be better.

Some Wavetables may be optimized for use with an LFO, instead. Try using a Triangle-shaped LFO to modulate **Position**.

MOD (Wavetable A Modifier)

Each waveform in a Wavetable is stored as a single 32-bit floating-point table with 2048 samples, referred to below as the “base table.” This corresponds to a pitch of about 25 Hz. Tables for higher pitches are generated when the Wavetable is loaded. The Wavetable Modifier options let you change how these tables are generated, creating different-sounding variations of the stored data.

None: The Wavetable is loaded without alteration.

Odd Only: This preserves only the odd harmonics. All even harmonics (2, 4, 6, etc.) are removed.

Even Only: This preserves the fundamental and all the even harmonics. All odd harmonics (3,5,7, etc.) are removed. The result can sound like a sine wave at the fundamental plus a waveform an octave above that.

Skip Every 3: This removes every third harmonic (3, 6, 9, etc.).

Odd + Clip: This combines *Odd Only* and *Hard Clip*, producing a brighter version of the Wavetable with increased overtones and only odd harmonics.

Even + Clip: This combines *Even Only* and *Hard Clip*, producing a brighter version of the Wavetable with increased overtones with only even harmonics.

Skip + Clip: This combines *Skip Every 3* and *Hard Clip*, producing a brighter version of the Wavetable with increased overtones and with every third harmonic removed.

Low 20: This removes all but the lowest 20 harmonics.

Low 12: This removes all but the lowest 12 harmonics.

Organ-ize: This emphasizes the harmonics that correspond to organ drawbars: 1 (8'), 2 (4'), 3 ($2\frac{2}{3}'$), 4 (2'), 5 ($1\frac{3}{5}'$), 6 ($1\frac{1}{3}'$), and 8 (1'). The other harmonics are still present, but greatly reduced. The result is drawbar organ sounds with “stops” based on the Wavetable.

Vintage 8: This quantizes to 8 bits and disables band-limiting for all but the highest notes, resulting in a brighter sound with higher noise and significant aliasing.

Vintage 12: This quantizes to 12 bits and disables band-limiting for all but the highest notes, resulting in a brighter sound with moderate amounts of noise and aliasing.

4 Steps: Quantizes the base table to 2 bits, using band-limiting to minimize aliasing (so, you'll notice that the displayed waveform is smoother than a simple 2-bit waveform).

8 Steps: Quantizes the waveform to 3 bits, similar to *4 Steps*, above.

16 Steps: Quantizes the waveform to 4 bits, similar to *4 Steps*, above.

Soft Clip: Applies gentle soft clipping to the base table, adding overtones and increasing brightness.

Hard Clip: Applies a gain of 3.0 and then clips the result, for a greater increase in overtones and brightness.

Infinite Clip: Applies a ridiculous amount of gain, then clips the result.

Note that *Soft Clip*, *Hard Clip*, and *Infinite Clip* are very different from applying clipping to the audio output. The timbre isn't affected by the oscillator level or the number of voices being played, and the results are band-limited to avoid harsh tones.

Tilt Up: This reduces the levels of lower harmonics, and increases the levels of higher harmonics, tilted around the 12th harmonic.

Tilt Up +: Similar to *Tilt Up*, but more extreme.

Tilt Down: This increases the levels of lower harmonics, and reduces the levels of higher harmonics, tilted around the 12th harmonic.

Tilt Down +: This increases the levels of lower harmonics, and reduces the levels of higher harmonics, tilted around the 8th harmonic.

Low Boost: Boosts the first 5 harmonics.

Low Cut: Reduces the fundamental and first few harmonics.

Low Cut +: Reduces the first 5 harmonics.

Muted: Dramatically lowers the level of all harmonics above the fundamental.

Fade Out: Crossfades successive waves in the Wavetable with 0 so that the waveform fades out to 0 as Position increases. Use this to create decaying plucked or percussive sounds just by sweeping the Position.

Reverse: Loads the Wavetable's individual waves in reverse order. This is particularly useful for Wavetables which sweep from a bright or complex sound on one end to a dark or simple sound on the other.

Gain +3 dB, Gain +6 dB, Gain -3 dB, Gain -6 dB: Increase or decrease gain by the specified amounts. These are particularly useful for balancing the volume between Wavetables A and B.

Tip: Fade between modified and original versions of a Wavetable

1. Set Mode to *A/B*.
2. Select the same Wavetable for both A and B.
3. Make sure that B Offset is set to 0.00.
4. Set Wavetable A Modifier to *None*.
5. Set Wavetable B Modifier as desired (for instance, *Hard Clip*).
6. Use **A/B BLEND** to fade between the normal and modified versions.

With *Hard Clip*, this will create a sound similar to a low-pass filter. Try modulating **A/B BLEND** via an Envelope or LFO! Since Wavetables A and B are phase-locked, you can use this technique to fine-tune the effects of any of the Modifiers. For example, try using this with any of the *Tilt*, *Boost*, or *Cut* options.

B (Wavetable B) (WAVE SELECT)

[List of Wavetables]

This selects the Wavetable for Wave B; it appears only if **Oscillator Mode** is set to *A/B*. **A/B BLEND** then controls the mix of Wavetables A and B. Pressing **WAVE SELECT** toggles between selecting **Wavetables A** and **B**.

MOD (Wavetable B Modifier)

This selects the Modifier for Wave B; it appears only if **Oscillator Mode** is set to *A/B*. For more information on Modifiers, see “MOD (Wavetable A Modifier)” on page 18.

Sample Mode

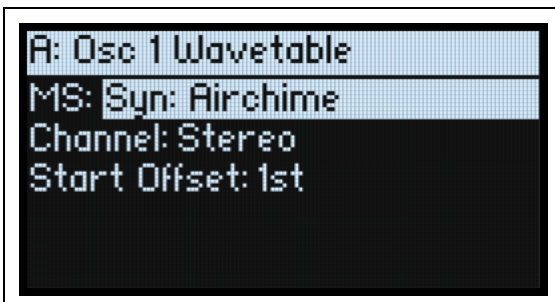

These parameters are shown when **Oscillator Mode** is set to *Sample*.

MS (Multisample)

[List of Multisamples]

Select this parameter and then either turn the **VALUE** knob or press **ENTER** to bring up the Multisample Select popup.

Channel

[Stereo, Left, Right, n/a]

This applies to stereo Multisamples only; for mono Multisamples, “n/a” is shown. You can choose whether to use the original *Stereo* signal, or only the *Left* or *Right* channels (in mono).

S. Offset (Start Offset)

[Off, 1st...8th]

In addition to simply starting playback from the beginning, Multisamples may have up to 8 different pre-programmed alternate starting points, or “Start Offsets.” These skip part of the beginning of the samples, either to make them more gentle (for percussive sounds) or to make them start more quickly (for sounds with slow attacks). The number of available offsets will vary depending on the specific Multisample.

If no alternate start points are available, this will show *n/a*.

Osc 1/2 Position

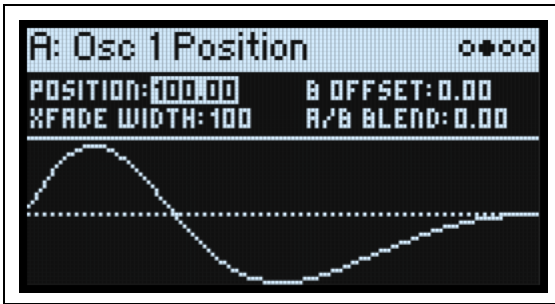

Position (POSITION)

[0.00... 100.00]

Wavetables contain up to 64 waveforms. Position sweeps through all of the waveforms in the Wavetable. 0.00 always selects the first waveform, and 100.00 selects the last waveform. The range between these extremes is divided between the total number of waveforms in the selected Wavetable, as shown below.

Note that when **Mode** is set to A/B, Wavetables A and B may have different numbers of waveforms. In this case, **Position** will divide the range evenly for each Wavetable, just as if they were being used individually. For instance, if A has four waveforms and B has 23 (see the graphic below), a **Position** just under 50 will play waveform 2 in A, and waveform 12 in B.

Position

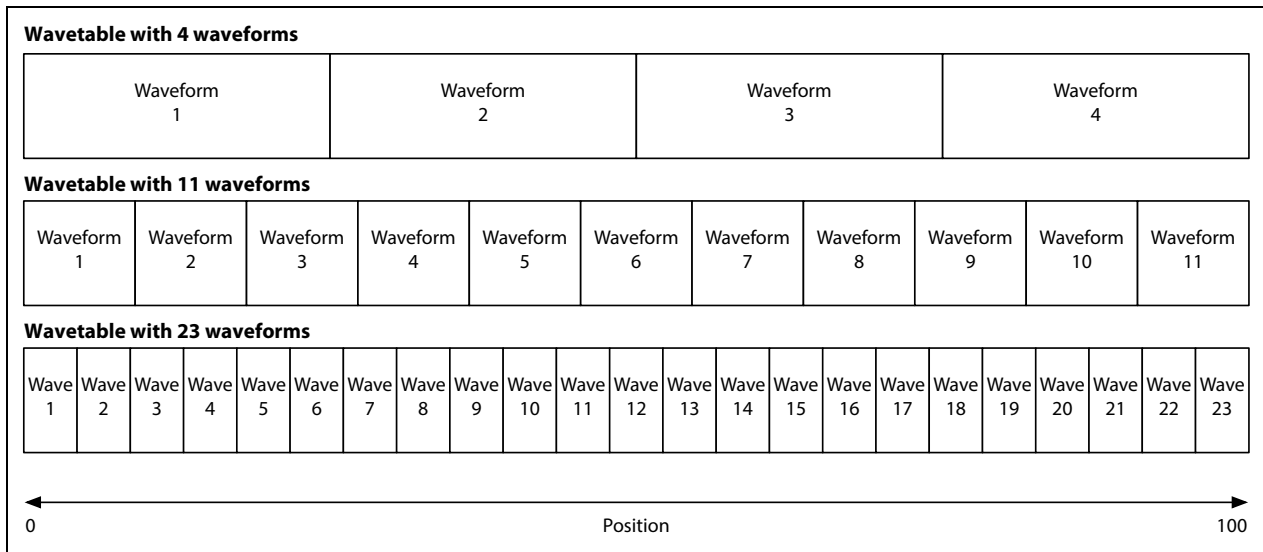

B Offset

[0.00... 100.00]

This appears only if **Mode** is set to A/B. The position of Wavetable B is the sum of **Position** (above) and **B Offset**.

A/B Blend (A/B BLEND)

[0.00... 100.00]

This appears only if **Mode** is set to A/B. It controls the balance between Waves A and B.

Xfade Width

[0.00... 100.00]

As the **Position** changes, the Wavetable changes from one waveform to another. When changing between two adjacent waveforms, the transition can be gradual or immediate. **Xfade Width** controls the amount of the **Position** range spent interpolating between neighboring waveforms vs. the amount playing single waveforms. Note that this does not affect **A/B Blend**.

Wavetable Osc

It may be helpful to think of the **Position** value range 0-100 as a ribbon, with the Wavetable stretched to fit, regardless of how many waveforms it contains. Each waveform is a stripe on the ribbon. **Xfade Width** controls the amount of blurring between the stripes. A given value for **Position** will always yield the same output, which will be either a solid stripe or some amount of blurring between two stripes. When **Position** changes continuously, as with an envelope or LFO, this causes crossfades between the waveforms.

Xfade Width

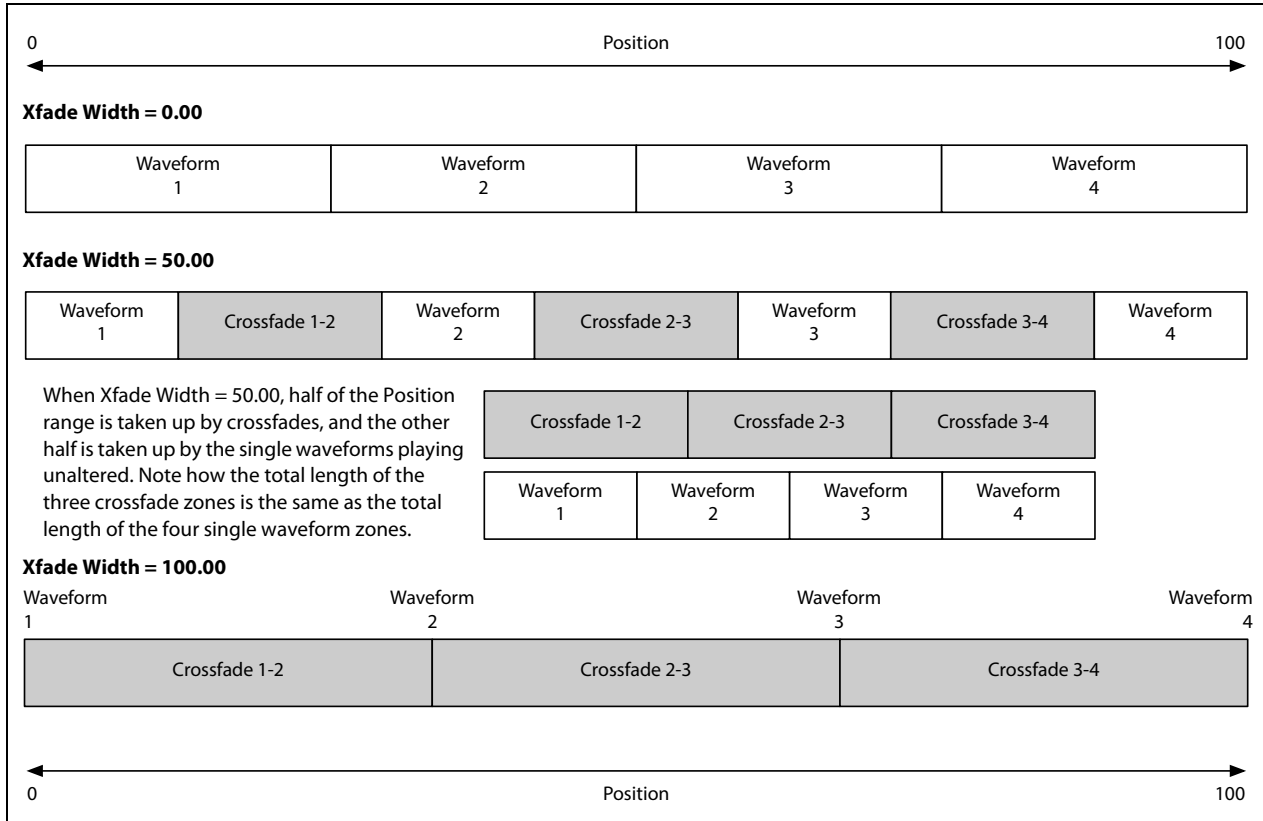

Osc 1/2 Morph

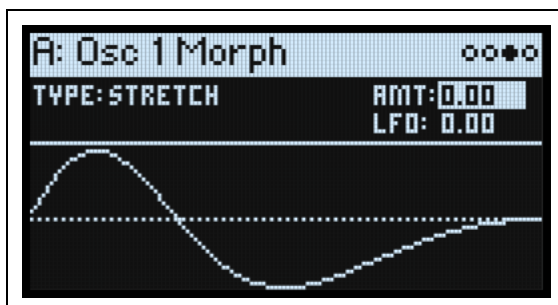

Morph Type (SHIFT-MORPH)

[List of Morph Types]

The Morph Types let you stretch, squeeze, reflect, and otherwise alter the Wavetables in real-time, changing their timbre and—when modulated—creating additional motion in the sound.

- When the Oscillator **MODE** is set to *Sample*, the **Morph Type** options are limited. For Oscillator 1, Morph is completely unavailable. For Oscillator 2, only the **AM** and **Ring Mod Morph Types** are available.

None: The Wavetable is played unaltered.

Sync: The Wavetable is reset by a phantom oscillator, creating the classic sync sound. Morph Amount controls the frequency of the phantom oscillator.

Wavetable Osc

Windowed Sync: Similar to *Sync* above, but with reduced high frequencies for lower aliasing.

Stretch: The waveform is stretched in one direction and squeezed in the other, creating an effect similar to Pulse Width Modulation. When **Morph Amount** is set to 50, the waveform is unaltered.

Flip: This inverts the polarity of a section of the waveform, with the “flip” point determined by **Morph Amount**.

Mirror: Shrinks the waveform to half its length, and then reflects that half-length waveform around the center as a mirror image. **Morph Amount** stretches and squeezes the waveform similar to *Stretch*, above.

Mirror Stretch: This is similar to *Mirror*, above, but doubles the *Stretch* effect.

Narrow: As Morph Amount increases, the waveform is compressed towards the front, with zeros filling the rest of the duty cycle. The effect is different from *Stretch*, but also has some similarities to Pulse Width Modulation.

Narrow Stretch: This combines *Narrow* and *Stretch*, compressing the waveform’s length while also stretching and squeezing.

Windowed Narrow: Similar to *Narrow* above, but with reduced high frequencies for lower aliasing.

W.NarrowStretch: Similar to *Narrow Stretch* above, but with reduced high frequencies for lower aliasing.

Additional Osc 2 Morph Types

Osc 2 supports all of the Morph Types listed above, and three more: *FM*, *AM*, and *Ring Mod*. For all of these, Oscillator 1 is the modulator, and Oscillator 2 is the carrier. If you’re using Oscillator 1 solely as a modulator, you may wish to set its **Level** to 0%.

Note: when using these Morph Types, the waveform graphic will be an approximation. If you’d like to see the exact results graphically, use the **ANALYZER** instead (see “Analyzer” on page 26).

FM: Oscillator 1 modulates the frequency of Oscillator 2. **Morph Amount** controls the amount of frequency modulation.

AM, or amplitude modulation, includes both ring modulation, as below, and the dry signal from Oscillator 2. **Morph Amount** controls the amount of amplitude modulation.

Ring Mod combines the two Oscillators to generate new sideband frequencies based on those inputs. The result can be everything from subtle brightening to wild, dissonant, gong-like timbres. When the frequencies of Oscillators 1 and 2 are the same, the Ring Modulator produces steady, constant waveforms. When they are detuned, it produces more movement and overtones. **Morph Amount** controls the amount of ring modulation.

AMT (Morph Amount) (MORPH)

[0.00...100.00]

This controls the intensity of the Morph process, as described above.

LFO (INTENSITY)

[-100.00...+100.00]

This sets the intensity of the Morph modulation from the Osc 1 LFO (for Osc 1) or the Osc 2 LFO (for Osc 2).

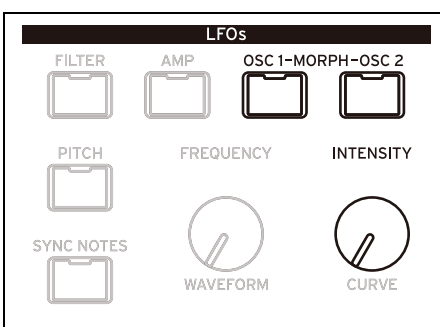

Osc 1/2 Details

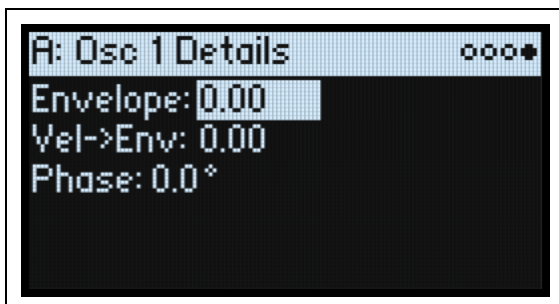

Envelope (OSC ENV INTENSITY)

[-100.00...+100.00]

This sets the amount of Position modulation from the Osc 1 Envelope (for Osc 1) or the Osc 2 Envelope (for Osc 2).

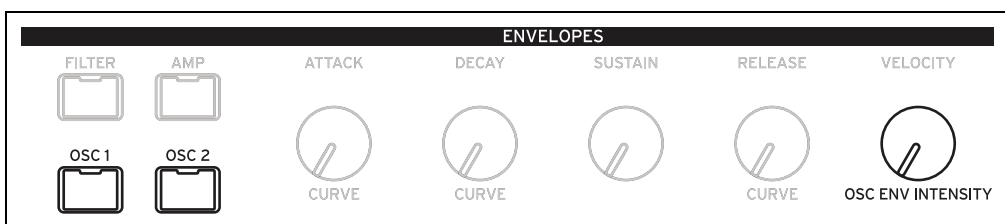

Vel->Env (VELOCITY)

[-100.00...+100.00]

This lets you use velocity to scale the amount of Position modulation from the Osc 1 Envelope (for Osc 1) or the Osc 2 Envelope (for Osc 2).

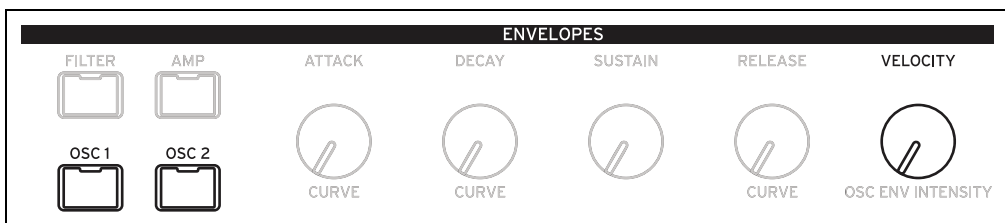

Phase

[-180...+180]

This controls the phase of the waveform at the start of the note. It's most useful when Oscillators 1 and 2 are not detuned.

Mixer & Sub Osc



Osc 1

Level (LEVEL)

[0%...100%]

This controls Oscillator 1's volume.

Pan (SHIFT-LEVEL)

[L100...L1, C0, R1...R100]

This controls Oscillator 1's stereo position.

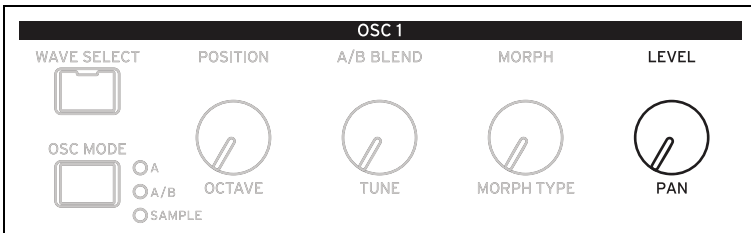

Osc 2

Level (LEVEL)

[0%...100%]

Pan (SHIFT-LEVEL)

[L100...L1, C0, R1...R100]

See the descriptions for Osc 1, above.

Sub/Noise

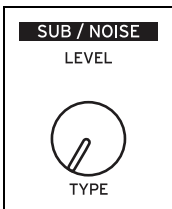

This section can be either a sub oscillator or a noise generator, depending on the selected **Sub/Noise Type**.

Sub/Noise Type (Sub/Noise) (SHIFT-LEVEL)

[Square, Triangle, White Noise, Filtered Noise, Dark Noise, Speckled Noise, Saturated Noise]

Square, Triangle: These produce the specified waveform at the same pitch as Osc 1, or one or two octaves below.

White Noise: This is classic, full-spectrum white noise.

Filtered Noise: Similar to *White Noise*, above, but less bright.

Dark Noise: Similar to *Filtered Noise*, but with significant high-end roll-off.

Wavetable Osc

Speckled Noise: This is noise with both roll-off and clipping, producing a very aggressive timbre. With additional lowpass filtering, it can produce sounds reminiscent of thunder and explosions.

Saturated Noise: This uses moderate filtering and saturation to produce a thicker-sounding noise signal.

Oct

[-2, -1, 0]

This applies only when **Sub/Noise Type** (on the Mixer & Sub Osc page) is set to *Square* or *Triangle*. It sets the pitch offset from Oscillator 1, in octaves. This parameter is duplicated on the Osc Pitch page. Set **Octave** to *-1* or *-2* to add rumbling bass, or to *0* to supplement the fundamental of a thin-sounding Wavetable.

Level (LEVEL)

[0%...100%]

This sets the volume of the Sub/Noise component.

Pan

[L100...L1, C0, R1...R100]

This sets the stereo position of the Sub/Noise component.

Analyzer

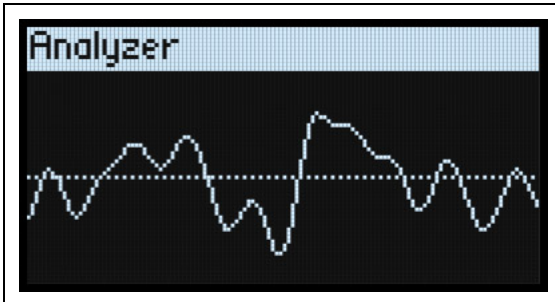

The Analyzer shows a real-time oscilloscope view of the full, polyphonic modwave audio output, including effects. Press **ANALYZER** to go to this page.

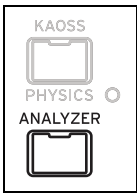

Motion Sequencing 2.0

What is Motion Sequencing 2.0?

Motion Sequencing 2.0 is evolved from the wavestate's Wave Sequencing 2.0. Sequences run individually for each voice. Timing, Pitch, Shape, and four sets of Step Sequence values (Seq A-D) are separated into "lanes." Each lane can have a different number of Steps, its own Loop Start and Loop End, and its own loop direction or step order randomization. Each Step in each Lane even has its own Probability.

Loop points, Step Probabilities, and other parameters in the lanes and their steps can be modulated on a per-note basis, using velocity, LFOs, envelopes, etc. Each time the sequence moves forward, values from the individual lanes are combined to create the output. The result can be either ever-changing rhythmic patterns or smooth, organic modulations.

You can easily record knob movements in real-time, enter pitch sequences from the keyboard, and constrain playback to a scale and key.

Motion Sequencing 2.0

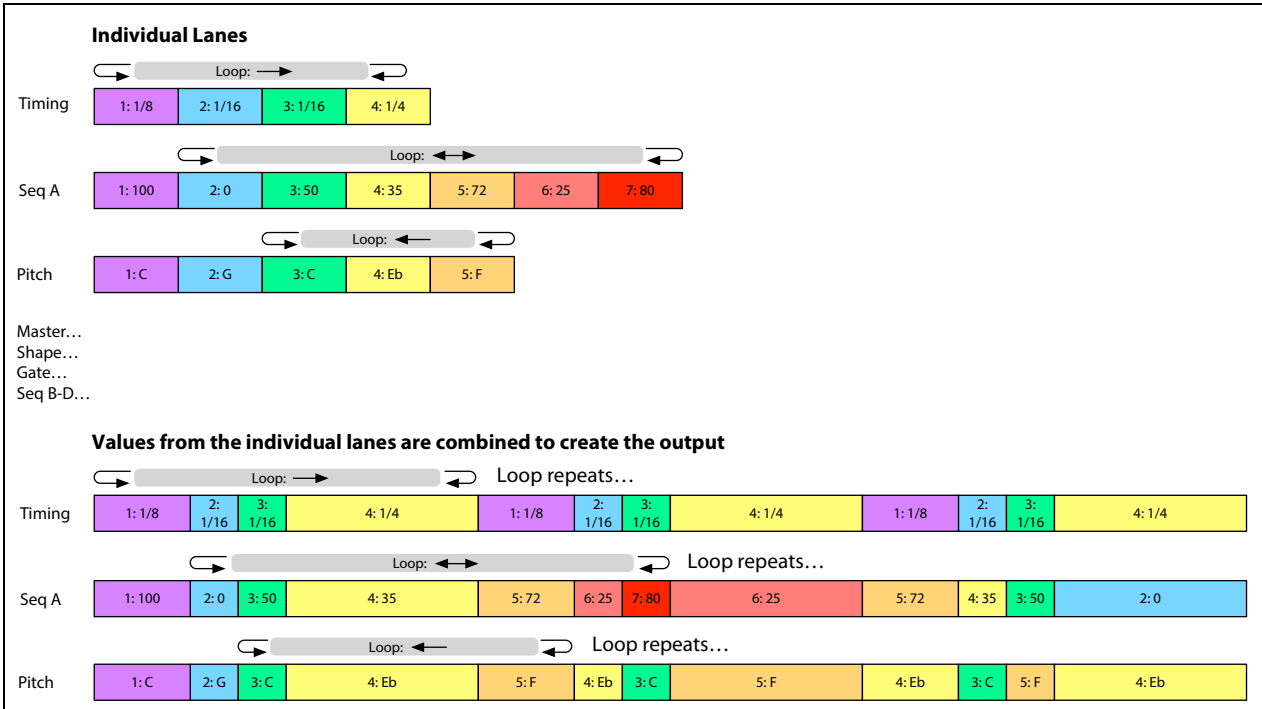

Motion Seq Overview

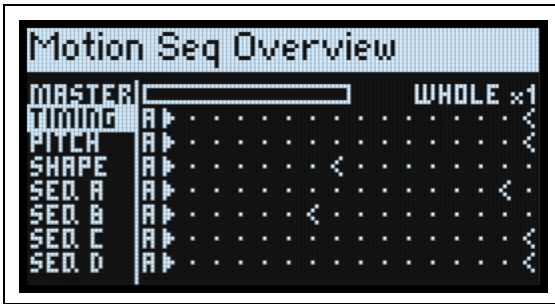

This shows all of the Motion Sequence Lanes for the Layer’s oldest sounding voice. It displays up to 16 steps at once, matching the 16 front-panel buttons, for each Layer. The bank, A/B/C/D, is shown to the left of the steps. For each lane, the display automatically shifts to show the bank containing the active step.

Note: Through modulation and probability, each voice in each Lane of each Motion Sequence may be on different steps, and may also have different Loop Start/Loop End settings.

Press **SHIFT-5 (SEQ VIEW)** to go to this page.

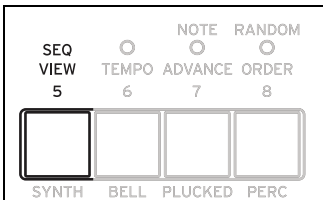

The overview uses a few different symbols, as shown below. One detail bears mention: if both loops are on the same step, the Coincident Loop symbol is shown.

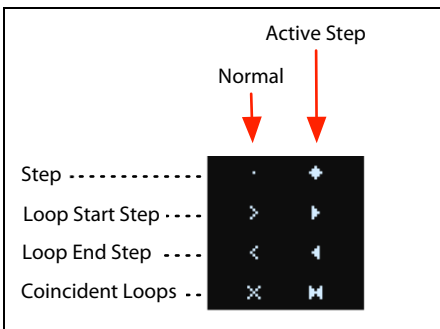

Master Lane Progress Bar

When enabled, the Master Lane restarts all of the other Lanes after either a specified number of beats or elapsed time; see “Master Lane” on page 33. The top-most line in the overview shows the current state of the Master Lane via a progress bar.

Motion Sequence Recording

Step recording Pitch

To record a sequence of notes into the Pitch lane:

1. Press **REC**.

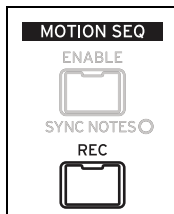

REC and buttons **11 (PITCH)** and **13-16 (SEQ A-D)** will blink.

2. Press button **11 (PITCH)** to select the Pitch Lane. Alternatively, press **REC** again to cancel.

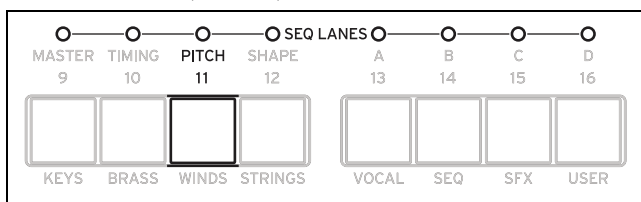

The Pitch Recording Setup page appears. Motion Sequence **ENABLE** is temporarily turned off, if it was on.

3. Play the root note for the key of the pitch sequence.

The Pitch lane stores offsets, instead of absolute pitches; those offsets will be calculated in relation to this root note. The default is C4. If you wish, you can also cursor to the on-screen parameter and enter a note using the **VALUE** knob.

4. Set Clear as desired.

There are several options for clearing the previous contents of the Pitch Lane.

Steps & Lane Settings resets all of the Pitch Lane settings, such as Loop Start and Loop End, to their defaults. Any modulation routings to the Lane parameters will also be erased.

Step data only leaves the Pitch Lane settings intact, but resets all the individual Steps. Use this to retain previous settings for modulation, specific loop points, and so on.

Don't clear leaves all of the data intact. Use this to edit a few steps in a previously-created pitch sequence.

5. Press **ENTER** to begin recording.

The screen shows the pitch for the current Step. There's also a small read-only display of the previous step, to help keep your orientation when recording. The **Loop** graphic shows the current position in the loop. The Bank and Step button LEDs show the current step number.

After playing and releasing a note, recording automatically advances to the next step.

To go back to a previous step—to correct a mistake, for instance—press **<**.

To skip to the next step without changing the current step, press **>**.

The recording will automatically stop when the Loop End is reached. To end recording before then, press **REC** (or any key other than **<** and **>**).

Real-time recording for Seq Lanes A-D

You can record into Seq Lanes A-D in real-time, using either front panel knobs or the Mod Wheel. If you record a parameter knob, such as **MORPH**, the Seq Lane is automatically routed to modulate that parameter. After recording, you can edit the results, including the individual values in the Lane Steps and the intensity of the modulation routing. You can also route the Seq Lane to modulate additional parameters, using the normal Add Modulation process; see "Adding Modulation Routings" on page 64.

Important: The Motion Sequence runs independently per voice. This means that it can only modulate per-voice parameters, such as settings in the Oscillators, Filter, Envelopes, and LFOs. Specifically, the Motion Sequence cannot record or modulate the Mod Knobs, effects, or Kaoss Physics.

Important: Loop modulation, random order, and note advance all apply during recording. For most deterministic use, use the option to Clear Steps & Lane Settings (see step 3 below), or disable these features manually!

Motion Sequencing 2.0

1. Press **REC**.

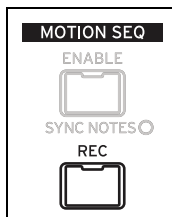

REC and buttons **11 (PITCH)** and **13-16 (SEQ A-D)** will blink.

2. Press one of buttons **13-16 (SEQ A-D)** to select a target Seq Lane. Alternatively, press **REC** again to cancel.

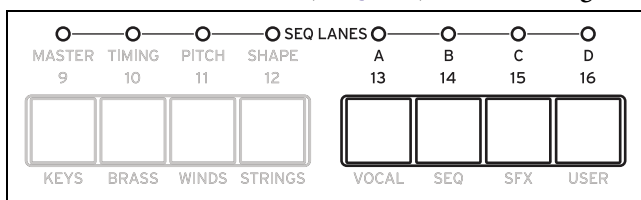

If there's already data in the selected Lane, you'll be prompted to clear the data.

3. If prompted, select an option for Clear, and then press **ENTER** to continue.

Steps & Lane Settings resets all of the Lane settings, such as Loop Start and Loop End, to their defaults. Any modulation routings to the Lane parameters will also be erased.

Step data only leaves the Lane settings intact, but resets all the individual Steps. Use this to retain previous settings for modulation, specific loop points, and so on.

4. When prompted by the display, play and hold a note.

Recording works best when playing a single note. Hold the note for the duration of the recording, either via the keyboard, the sustain pedal, or the **HOLD** button. If you release the note, recording will stop.

Once you play a note, the display changes to show the recording screen. The **Loop** graphic shows the current position in the loop.

5. To record, move a knob in the Oscillator, Filter, Envelope, or LFO sections, or move the Mod Wheel.

Once you move a knob or the Mod Wheel, recording starts. The **Knob** graphic shows name of the knob being recorded, and **Value** shows the values being recorded. You'll see the **Loop** graphic begin to fill in, showing the section of the loop which has been recorded. You can start at any time during the loop; recording will wrap around if necessary. Once the entire loop has been recorded, recording stops automatically.

Recording a knob creates a modulation routing from the Seq Lane to the knob's parameter. (Recording the Mod Wheel records values only; modulation routings must then be created separately.) After recording, you can edit individual step values, change the intensity of the modulation routing, or create new modulation routings using the recorded Seq Lane as the source.

The initial position of the knob sets the "0" point. Moving the knob counter-clockwise goes from the current value to the minimum; moving clockwise goes from the current value to the maximum. If you turn the knob all the way to the left or right, the range is reset. See the graphic below.

Knob position and recorded values

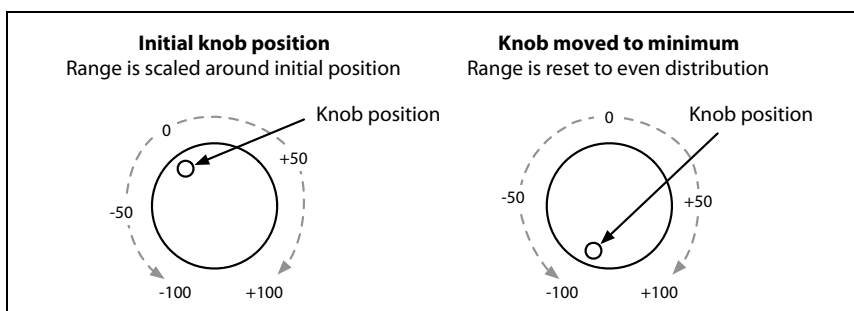

Other notes

- Only one knob can be recorded per Lane; if a second knob is moved during recording, it is ignored.
- The value is recorded at the end of the step.

- One value is recorded per step; for finer resolution in time, use a faster timing lane.
- For playback closest to the original knob movements, leave the Lane’s **Transition** set to *Linear* (the default).

Motion Sequence editing

Editing Lanes

The Lane controls which of its Steps are played, and how they loop. Changing the **Loop Start** or **Loop End**, for instance, may significantly change the character of the sound; see “Standard Lane Controls” on page 34. Some Lanes have special parameters in addition to the standard controls, as described in the following sections.

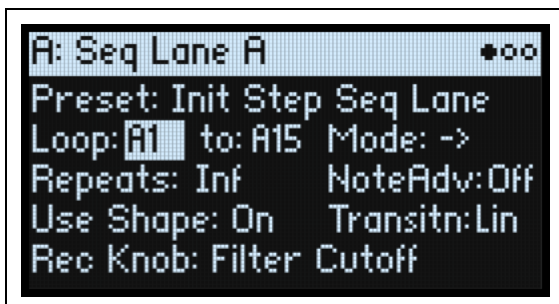

Editing Steps

There are up to 64 Steps per Lane, in four banks: A1-A16, B1-B16, etc. To view and edit individual Steps:

1. **Select the desired Lane by holding SHIFT and pressing one of buttons 10-16.**

For example, to select Seq Lane A, press SHIFT-13.

2. **Press the SEQ STEPS button, so that it is lit.**

The 16 buttons at the bottom of the panel now select Steps. The current Step’s LED is brightly lit; Steps within the programmed loop range (ignoring modulation) are also subtly illuminated.

3. **To select Steps in the current bank, press buttons 1-16.**

or:

To select from a different bank, first hold either SHIFT or SEQ STEPS and then press 1/2/3/4 to select the bank. Buttons 1-16 will then blink; press one to select a Step in the new bank.

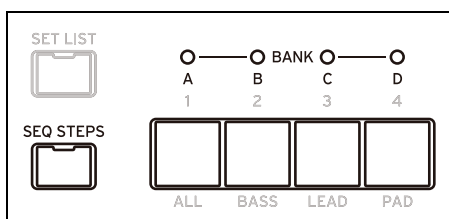

As you select different steps, the current parameter remains the same. For instance, if you are editing the Pitch for a number of steps, you can quickly select Steps in succession, editing the Pitch via the value knob.

4. **Edit as desired using the onscreen controls (cursor and VALUE knob).**

Step Solo mode

Step solo mode makes the Lane temporarily loop on the selected Step, for auditioning values or shapes, troubleshooting, etc.

To enter Step Solo mode:

1. **Hold ENTER and press a Step button.**

Both the Step button and the current Lane’s button will blink.

The Motion Sequence will play as if that Lane was set to loop on the selected Step. Other Lanes will continue to play normally. If you select other Steps in the current Lane, solo will follow the selected Step.

To exit Step Solo mode, hold **ENTER** and press any Step button, or the current Lane’s button.

Only one Lane at a time can be in Step Solo mode. If you enter Step Solo mode for a second Lane, the first Lane’s Step Solo mode is turned off automatically. Changing to a different Layer also turns off Step Solo mode.

Motion Sequencer



This page lets you choose a Motion Sequence for the Program. Press **SEQ STEPS** to go to this page.

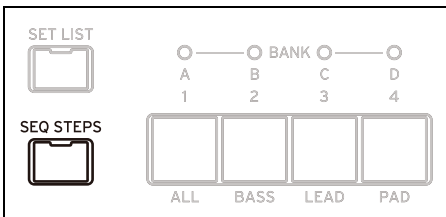

Preset (**SEQ STEPS**)

[List of Presets]

This list includes all of the Motion Sequence Presets stored in the database.

Enable (**ENABLE**)

[Off, On]

This turns the Motion Sequencer on and off for the current Layer.

Sync Notes (**SYNC NOTES**)

[Off, On]

Sync Notes sets whether individual notes play on their own separate timelines, or whether they are sync'd together.

Off: Each note's Motion Sequence will play independently.

On: If at least one note of the Program is already playing, the Motion Sequence lanes for newly played notes will start on the same steps as those of the oldest note. See the graphic below. There may still be variations due to per-note modulation or Probability.

Additionally, for all Layers which have both **SYNC NOTES** and **TEMPO** turned *On*, their Motion Sequences will sync together.

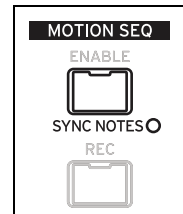

Motion Sequencing 2.0

Sync Notes

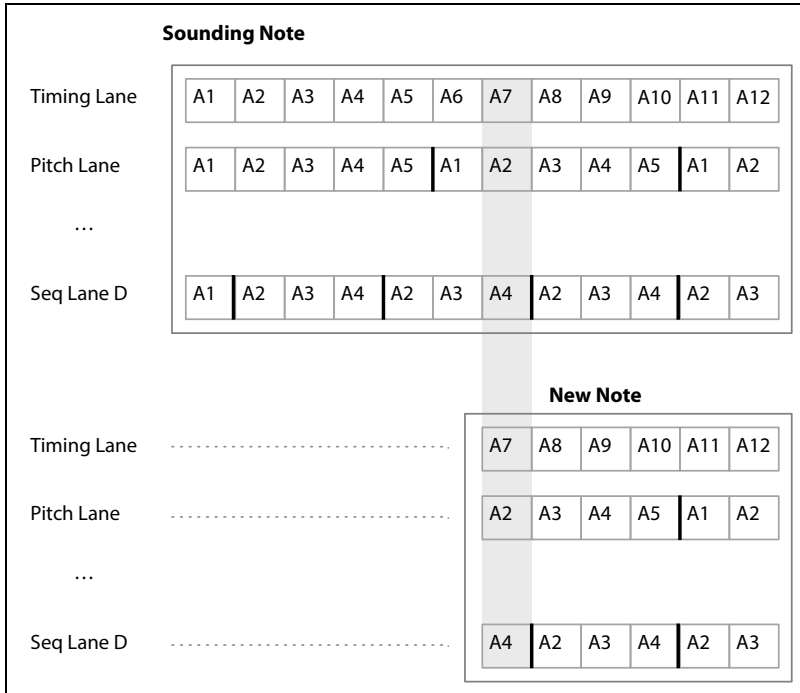

Use Master

[Off, On]

This enables the Master Lane; for more information, see “Master Lane” on page 33.

TEMPO (SHIFT-6)

[Off, On]

Tempo Off/On is stored in the Timing Lane; the parameter is duplicated here for convenience. For more information, see “TEMPO (SHIFT-6)” on page 36.

Master Lane



When **Use Master** is *On*, the Master Lane restarts all of the other Lanes after either a specified number of beats or elapsed time, depending on the **TEMPO** On/Off setting. You can use this to create regularly repeating patterns, even if the different Lanes all have irregular loop lengths.

Press **SHIFT-9 (MASTER)** to go to this page.

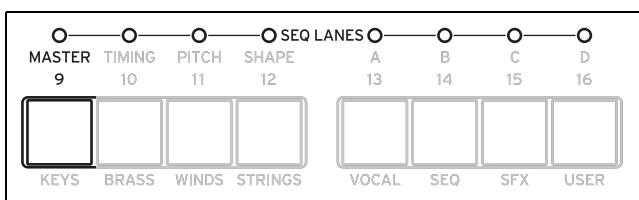

Use Master

[Off, On]

Off: The Master Lane is disabled.

On: The Master Lane is enabled, and restarts other Lanes as described above.

Loop Duration

[TEMPO Off: 0.0013...120.0000 seconds]

[TEMPO On: 32nd-note triplet...2x breve]

If Timing Lane **Tempo** is *Off*, you can set the length of the Master Lane loop in seconds.

If Timing Lane **Tempo** is *On*, this sets the basic length of the Master Lane, relative to the system tempo.

x (Multiply Base Note by...)

[1...32]

This appears only if **Tempo** is *On*. It multiplies the length of the **Base Note**. For instance, if the **Base Note** is set to a whole note, and **Times** is set to 3, the Master Lane will reset every three whole notes.

TEMPO (SHIFT-6)

[Off, On]

Tempo *Off/On* is stored in the Timing Lane; the parameter is duplicated here for convenience. For more information, see “**TEMPO (SHIFT-6)**” on page 36.

Standard Lane Controls

These controls apply to all lanes except Master.

Preset

Lane Presets store all of the parameters for the Lane and its Steps. Explore the system by mixing and matching presets for different Lanes.

Loop (Loop Start), to (Loop End)

These parameters control the Steps on which the Lane begins, ends, and loops. You can change them in real-time, while notes are sounding—and also modulate them via LFOs, Envelopes, etc.

 If you want to modulate loop points, use these parameters to set the maximum loop length. **Loop Start** can only be modulated upwards, and **Loop End** can only be modulated downwards.

Mode

This controls the way that the Lane plays: Forward Loop, Backward Loop, alternating Forward-Backward Loop, or Random order. You can also enable Random order using the **RANDOM ORDER** button (**SHIFT-8**).

Repeats

[Off, 1...100, Inf]

This controls the number of times that the Lane will loop. The default is *Inf*, which causes the loop to repeat as long as the note is held.

NoteAdv (NOTE ADVANCE, SHIFT-7)

When this is *On*, each note played will increment the Start Step by one. Try using this with the Arpeggiator!

RANDOM ORDER (SHIFT-8)

When this is *On*, the Steps will play in a different order every time the loop repeats.

To understand how **Random Order** works, imagine that each Step is on a note-card. Each time the loop plays, or whenever the **Loop Start** or **Loop End** changes, the note-cards from the **Loop Start** through the **Loop End** are shuffled and assigned to new numbers (A1, A2, etc.). Steps before the **Loop Start** and after the **Loop End** are ignored.

Step Probability

Each individual Step has a **Probability** setting, from 0% to 100%. This controls how likely the Step is to play. As with most Step parameters, **Probability** can be modulated; for instance, moving a Mod Knob might make some Steps more likely to occur, and other steps less likely to occur.

If a step has less than 100% **Probability** and loses the roll of the dice, as it were, it is skipped. (See note about the Timing Lane, below.) Since the Motion Sequence is generated in real-time, we need to avoid a situation in which we repeatedly roll the dice, lose the throw, and roll again and again; eventually, we need to make some sound! So, if two steps in a row are skipped, the third step always is played—even if its probability is 0%.

Timing Lane probability

The Timing Lane works slightly differently regarding probability: “skipped” steps are absorbed into the previous step. For instance, if A1 and A2 are both 16th notes, and A2 is skipped due to probability, A1 becomes an 8th note. This maintains the overall length of the rhythm.

Timing

This Lane controls the duration of each Step, creating rhythms or points on a timeline.

Timing Lane

Tempo On

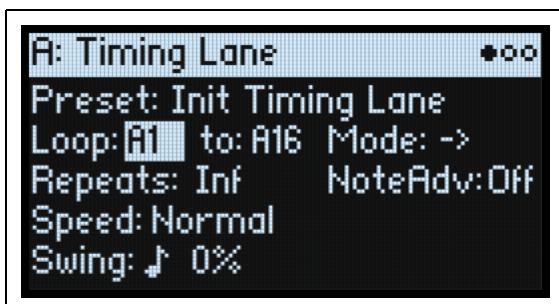

Tempo Off



Press **SHIFT-10 (TIMING)** to go to this page.

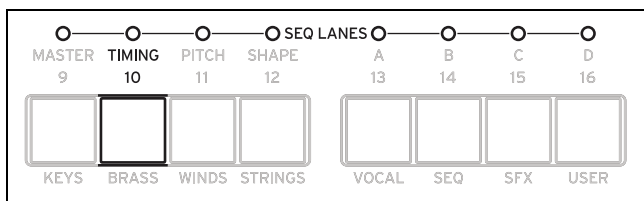

Preset, Loop (Start), to (Loop End), Mode, Repeats, NoteAdv

See “Standard Lane Controls” on page 34.

TEMPO (SHIFT-6)

[Off, On]

Off: Step Durations are specified in seconds.

On: Step Durations are specified in rhythmic values.

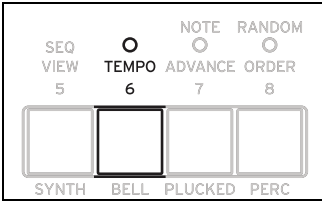

Speed

[TEMPO Off: 0.01...1.00...100.00]

[TEMPO On: 1/4...Normal...4x]

This modifies the speed of the entire Timing Lane. When TEMPO is Off, you can vary this continually from 0.01 (1/100 of the original speed) to 100.00 (100 times the original speed). Try modulating this from an envelope!

When TEMPO is On, you can select tempo-locked ratios from 1/4 to 4x of the original Speed.

Swing (Resolution)

[32nd-note triplet...quarter-note]

(Swing Amount)

[-300...+300%]

Swing adjusts the timing of up-beats relative to the Swing Resolution. For instance, if Resolution is set to 1/8, Swing affects every other 8th note.

+100%: Full “swing.” Up-beats become triplets, moving one third of the way toward the next down-beat.

+300%: Up-beats move all the way to the next down-beat.

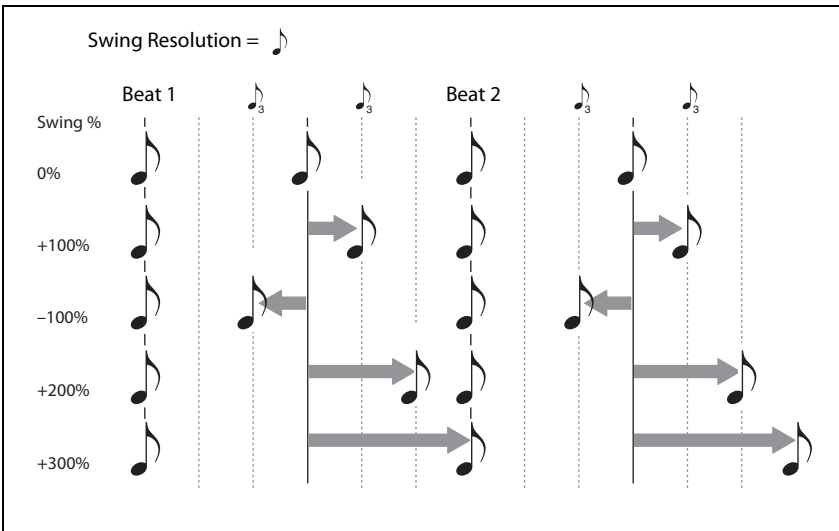

Timing Lane Step

Tempo On

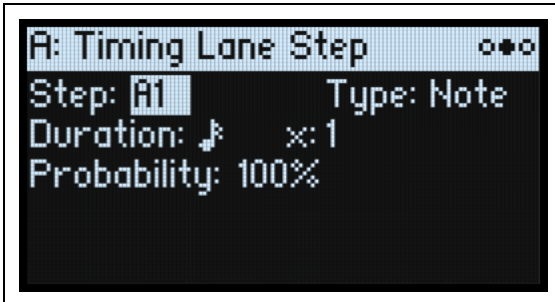

Tempo Off

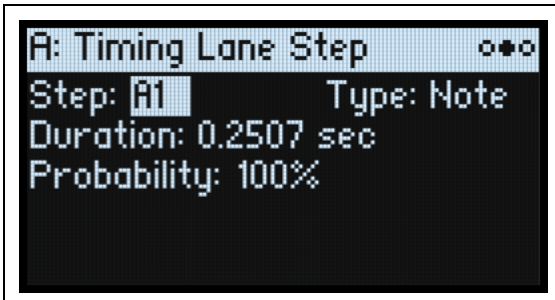

Step

[A1...D16]

This is the current Step. You can edit this parameter on-screen, or use the **SEQ STEP** buttons to select Steps directly.

Type

[Note, Rest, Gate]

Note: The step will play normally.

Rest: The step will be silent.

Gate: The sequence will pause at the step until note-off, after which the sequence continues. If this is also the End Step, the Motion Sequence will stay on the step through note-off. By setting a single Timing Step to *Gate*, and then modulating the Lane Start Step by velocity, you can create a sound with up to 64 velocity switches. For instance, you can use this to switch between a large number of different Shapes.

Duration

[TEMPO Off: 0.0000...10.0000 seconds]

[TEMPO On: List of rhythmic values]

If **TEMPO** is *Off*, you can set the length of the step in seconds.

If **TEMPO** is *On*, you can set the basic length of the step as a rhythmic value, relative to the system tempo. The values range from a 32nd note to a double breve (four whole notes), including dotted notes and triplets. This length is then modified by **x** (**Multiply Base Note by...**), below.

x (Multiply Base Note by...)

[1...32]

This appears only if **TEMPO** is *On*. It multiplies the length of the **Duration Base Note**. For instance, if the **Base Note** is set to an eighth note, and **Times** is set to 3, the step will last for a dotted quarter-note.

Probability

See “Step Probability” on page 35.

Pitch

This Lane sets the pitch of each Step.

Pitch Lane



Press **SHIFT-11 (PITCH)** to go to this page.

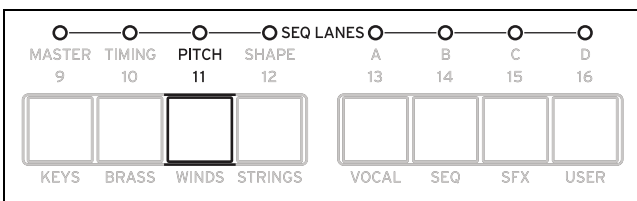

Preset, Loop (Start), to (Loop End), Mode, Repeats, NoteAdv

See “Standard Lane Controls” on page 34.

Use Shape

[Off, On]

When this is *On*, non-zero pitch values will be scaled by the Shape Lane. If the pitch offsets are zero, **Shape** has no effect. Note that **Shape** interacts with **Transition**, below; to hear Shapes unaltered, set **Transition** to *Off*.

Transitr (Transition)

[Off, Lin, Exp, Log, Indv]

This controls whether the pitch changes abruptly at each new step, or glides to the new value.

Off: Pitch will change abruptly at each step. This is the default.

Lin: The pitch will glide linearly from step to step.

Exp: The pitch will glide from step to step, with most of the change at the end of the glide.

Log: The pitch will glide from step to step, with most of the change at the start of the glide.

Indv (Individual): The pitch transitions will be controlled separately per Step. This lets you create melodic patterns which combine abrupt steps and glides, like a classic bass groove-box.

Fit to Scale

[Off, On]

This lets you constrain the Pitch Lane’s output to a specific scale and key—especially useful when playing polyphonically.

Off: Pitch offsets will be played exactly as they are entered in the sequence.

On: Pitches will be constrained to the specified scale and key.

(Scale Key)

[C...B]

This sets the root note of the scale. For instance, if Scale Key is set to E, and the Scale Type is set to Minor, all notes generated by the Pitch Lane will be confined to notes in the E Minor scale: E, F#, G, A, B, C, or D.

Scale Key only applies if **Fit To Scale** is *On*.

Motion Sequencing 2.0

(Scale Type)

[Major, Minor, Hrmnic Maj, Hrmnic Min, Melodic Min, Dorian, Phrygian, Lydian, Mixolydian, Locrian, Penta Maj, Penta Min, Diminished, Half Dim, Augmented, Whole Tone, Tritone, Blues, Bebop Dom, Flamenco, Romani, Hungarian, Persian, Harmonics, Acoustic, Enigmatic]

This selects the scale to which the generated notes will be confined. It only applies if **Fit To Scale** is *On*.

	Notes generated by Pitch Lane (if Scale Key = C)											
Scale	C	C#	D	D#	E	F	F#	G	G#	A	A#	B
Major	C	C	D	E	E	F	G	G	A	A	B	B
Minor	C	C	D	D#	D#	F	G	G	G#	G#	A#	A#
HarmonicMajor	C	C	D	E	E	F	G	G	G#	G#	B	B
HarmonicMinor	C	C	D	D#	D#	F	G	G	G#	G#	B	B
MelodicMinor	C	C	D	D#	D#	F	G	G	A	A	B	B
Dorian	C	C	D	D#	D#	F	G	G	A	A	A#	A#
Phrygian	C	C#	D#	D#	F	F	G	G	G#	G#	A#	A#
Lydian	C	C	D	E	E	F#	F#	G	A	A	B	B
Mixolydian	C	C	D	E	E	F	G	G	A	A	A#	A#
Locrian	C	C#	D#	D#	F	F	F#	F#	G#	G#	A#	A#
MajorPentatonic	C	C	D	D	E	E	G	G	G	A	A	A
MinorPentatonic	C	C	D#	D#	D#	F	F	G	G	A#	A#	A#
Diminished	C	C	D	D#	D#	F	F#	F#	G#	A	A	B
HalfDiminished	C	C	D	D#	F	F	F#	F#	G#	G#	A#	A#
Augmented	C	C	D#	D#	E	E	G	G	G#	G#	B	B
WholeTone	C	C	D	E	E	F#	F#	G#	G#	A#	A#	A#
Tritone	C	C#	C#	E	E	F#	F#	G	G	A#	A#	A#
BluesScale	C	C	D#	D#	D#	F	F#	G	G	A#	A#	A#
BebopDominant	C	C	D	E	E	F	G	G	A	A	A#	B
Flamenco	C	C#	C#	E	E	F	G	G	G#	G#	B	B
Romani	C	C	D	D#	D#	F#	F#	G	G#	G#	A#	A#
HungarianMinor	C	C	D	D#	D#	F#	F#	G	G#	G#	B	B
Persian	C	C#	C#	E	E	F	F#	F#	G#	G#	B	B
Harmonics	C	C	D#	D#	E	F	G	G	G	A	A	A
Acoustic	C	C	D	E	E	F#	F#	G	A	A	A#	A#
Enigmatic	C	C#	C#	E	E	F#	F#	G#	G#	A#	B	B

Pitch Lane Step



Step

See “Step” on page 37.

Transpose

[-24...+24 semitones]

This offsets the played note by up to two octaves, up or down.

If the Oscillator is playing a Multisample, this also affects the index into the Multisample map (unlike **Tune** below), potentially changing the sample selection, similar to transposing the entire keyboard.

Tune

[-12.00...+12.00 semitones]

This changes the tuning by up to one octave up or down.

Transition

[Off, Lin, Exp, Log]

This controls the transition from *this* step to the *next* step: whether the pitch changes abruptly at the *next* step, or glides to the new value.

 This applies only if the Pitch Lane **Transitn** parameter is set to *Indv* (Individual).

Off: Pitch will change abruptly at the next step. This is the default.

Lin: The pitch will glide linearly to the next step.

Exp: The pitch will glide to the next step, with most of the change at the end of the glide.

Log: The pitch will glide to the next step, with most of the change at the start of the glide.

Probability

See “Step Probability” on page 35.

Shape

The Shape Lane creates a contour over the duration of the step. It can affect the Pitch Lane and/or any of the Seq Lanes (when the respective Lane's **Use Shape** is *On*).

Shape Lane

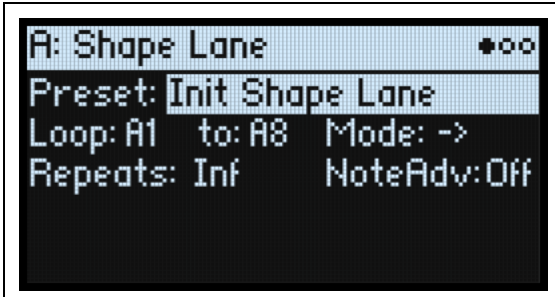

Press **SHIFT-12 (SHAPE)** to go to this page.

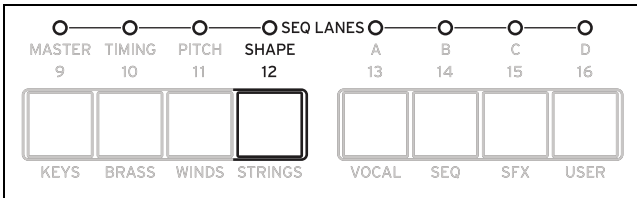

Preset, Loop (Start), to (Loop End), Mode, Repeats, NoteAdv

See "Standard Lane Controls" on page 34.

Shape Lane Step

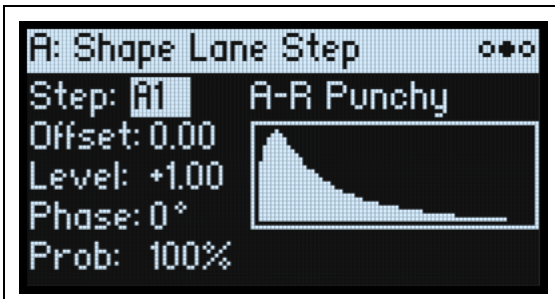

Step

See "Step" on page 37.

Shape

[List of shapes]

There are a large number of shapes to choose from, including ones with two, three, or four pulses.

Offset

[-1.00...+1.00]

This offsets the entire shape up or down. **Offset** works in conjunction with **Level**, below, similar to **Offset** and **Amount** in Mod Processor "Gate" on page 76. For instance, if you want Shape to control volume, but don't want the volume to drop all the way to silence, set both **Offset** and **Level** to +0.50.

Level

[-2.00...+2.00]

This varies the amplitude of the Shape. Negative values invert the shape.

Phase

[-180...+180°]

This controls the start point of the shape. For example, to start in the middle of the shape, set the Phase to +180°.

Prob (Probability)

See “Step Probability” on page 35.

Seq A/B/C/D

The four Seq Lanes generate modulation sources to control other synthesis parameters, just like envelopes, LFOs, etc.

Seq Lane

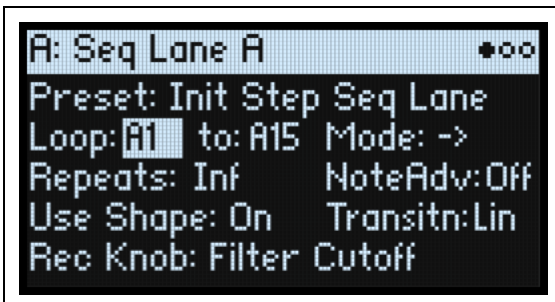

Press **SHIFT-13...16 (SEQ A...D)** to go to this page.

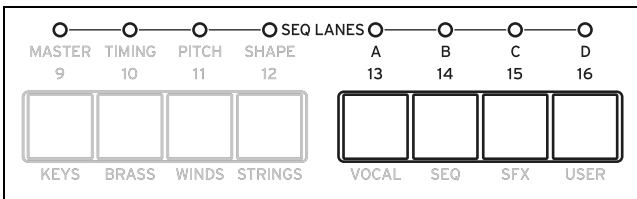

Preset, Loop (Start), to (Loop End), Mode, Repeats, NoteAdv

See “Standard Lane Controls” on page 34.

Use Shape

[Off, On]

When this is *On*, non-zero values will be scaled by the Shape Lane. Note that **Shape** interacts with **Transition**, below; to hear Shapes unaltered, set **Transition** to *Off*.

Transitn (Transition)

[Off, Lin, Exp, Log, Indv]

This controls whether the pitch changes abruptly at each new step, or glides to the new value.

Off: Values will change abruptly at each step.

Lin: Values will glide linearly from step to step, as if you were moving a knob continuously. This is the default.

Exp: Values will glide from step to step, with most of the change at the end of the glide.

Log: Values will glide from step to step, with most of the change at the start of the glide.

Indv (Individual): Transitions will be controlled separately per Step. This lets you create complex patterns which combine abrupt steps and glides.

Rec Knob

[Read-only]

If the Seq Lane was created by real-time recording, this shows the name of the parameter that was recorded. (See “Real-time recording for Seq Lanes A-D” on page 29.) Otherwise, it shows *None*. Note that the Seq Lane may be modulating other parameters as well, and that the modulation routing to the recorded knob may be changed or even deleted entirely.

Seq Lane Step



Step

[A1...D16]

See “Step” on page 37.

Type

[**Value + Continuous Mod**, **Value * Random +/-**, **Value * Random +**, **Value + S & H Mod**]

Value + Continuous Mod: The Step uses the programmed value, and modulation continuously affects the value. For instance, if an LFO is modulating **Value**, you’ll hear the LFO’s shape during the step.

*Value * Random +/-*: The Step’s **Value** is scaled by a bipolar random amount. The result may be either positive or negative.

*Value * Random +*: The Step’s **Value** is scaled by a unipolar random amount. If the **Value** is positive, the output will be positive; if the **Value** is negative, the output will be negative.

Value + S & H Mod: The Step uses the programmed value, and modulation is updated only at the start of the Step. For instance, if an LFO is modulating **Value**, only the LFO’s amplitude at the very start of the step matters; you will **not** hear the LFO’s shape during the step.

Value

[-100...100%]

This sets the output level for the Step.

Transition

[Off, Lin, Exp, Log]

This controls the transition from *this* step to the *next* step: whether the value changes abruptly at the *next* step, or glides to the new level.

 This applies only if the Shape Lane **Transitn** parameter is set to *Indv* (Individual).

Off: The value will change abruptly at the next step.

Lin: The value will glide linearly to the next step, as if you were moving a knob continuously. This is the default.

Exp: The value will glide to the next step, with most of the change at the end of the glide.

Log: The value will glide to the next step, with most of the change at the start of the glide.

Probability

See “Step Probability” on page 35.

Motion Sequence Utility

Cut Steps, Copy Steps, Paste Steps, Insert Steps

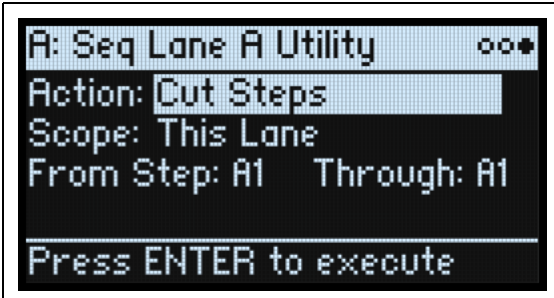

To cut, copy, paste, or insert Steps to either a single Lane or all Lanes:

1. From a Motion Sequence Lane page, use **PAGE+** to go to the Lane Utility page.
2. Select an Action such as Cut Steps or Insert Steps.
3. Set the Scope as desired, to apply the Action to all Lanes or to only the current Lane.
4. Set the other parameters (From Step, Through, etc.) as desired.
5. Press **ENTER** to execute the command.

Clear

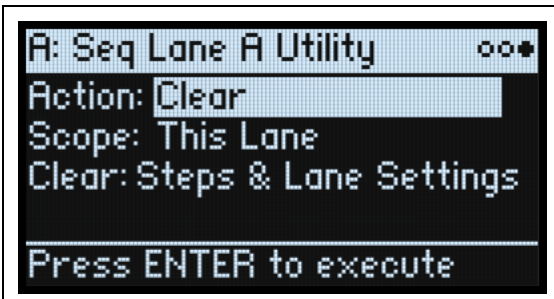

This Action allows you to reset either a single Lane or all Lanes to their defaults. There are two choices for what to clear:

Steps & Lane Settings resets all of the Step data and all of the Lane parameters, such as Loop Start and Loop End, to their defaults. Any modulation routings to the Lane parameters will also be erased.

Step data only will leave the Lane settings intact, but reset all the individual Steps. Use this to retain previous settings for modulation, specific loop points, and so on.

To use Clear, follow the general instructions under “Cut Steps, Copy Steps, Paste Steps, Insert Steps,” above, selecting Clear as the Action.

Scale Timing

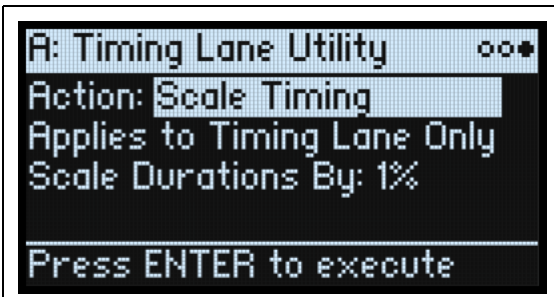

This Action is available only when entering the Motion Sequence Utility page via the Timing Lane. It allows you to edit all of the Timing Lane Step Durations at once, to make the sequence longer or shorter. If you want to change this in real-time, use the Timing Lane **Speed** parameter instead.

Kaoss Physics

Overview

Kaoss Physics models a ball rolling on a surface. You can start the ball by flicking a finger on the x-y pad, or launch the ball automatically using a trigger source such as *Gate + Damper*. You can also directly control the ball by holding your finger on the pad. The position of the ball produces several modulation signals (which can be used to control any modulation destination):

- *Kaoss X* is the horizontal position of the ball: negative to the left of center, 0 in the middle, and positive to the right.
- *Kaoss Y* is the vertical position: negative below the center, 0 in the middle, and positive above the center.
- *Kaoss Distance* is the distance from the center, which is always positive.
- *Kaoss Angle* is the current angle of the ball relative to the x axis. The value is always positive, regardless of whether it is above or below the x axis.

Kaoss Angle

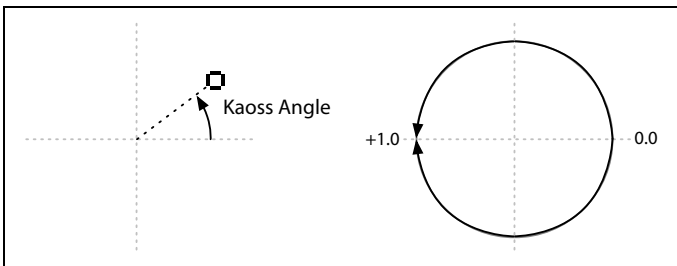

There is a bump in the surface, going either down or up, like a hole or a hill. You can set the height or depth of the bump, and choose one of several different shapes for its slopes. The surface has adjustable friction, so that the ball slows down as it travels. There are walls on the four sides of the surface, and when the ball hits a wall, it bounces off. Walls can slow down the ball, as if they were padded, or accelerate the ball, like bumpers in a pinball machine. The walls can also be removed entirely, so that the surface wraps around to the opposite edges like a vintage arcade game.

Note that most parameters, including **Tilt**, **Friction**, **Time**, **Bump Height** and **Position**, etc. are modulatable. You can even modulate them from the Kaoss Physics outputs—for instance, try modulating **Tilt X** with *Kaoss Y*.

Using Kaoss Physics to create specific results

Kaoss Physics can be interesting in itself, but you can also use it to create specific modulation effects. For instance:

- Use a centered **Bump** with negative **Height** so that the modulation values always eventually return to 0
- Position a **Bump** with positive **Height** on a side or a corner, to push modulation values *away* from that zone
- Set up opposing edges (top and bottom, and/or left and right) so that one has positive **Bounce** and the other has negative **Bounce**, so that the ball repeatedly speeds up and slows down
- Use **Friction** to slow down the ball over time, so that movement ends gradually and naturally
- Use the different forces—**Tilt**, **Friction**, **Bump Height**, and **Bounce**—to oppose and balance one another

Kaoss Physics and MIDI

When you move your finger on the x-y pad, the X and Y positions are sent as MIDI CCs 18 and 19, respectively. When you lift your finger off of the x-y pad to “throw” the ball, the release position, direction, and velocity of the throw are sent in high resolution via a single MIDI System Exclusive message.

When these MIDI messages are received, they’re processed by Kaoss Physics as if you were playing live on the x-y pad. Note that the movement of the ball is not directly transmitted or received.

The System Exclusive message includes all of the information necessary to recreate a “throw” (which would otherwise have required many separate CC messages), and is formatted as follows:

f0 42 3g 64 00 (Header; g=Global Channel)

<pos x LSB> <pos x MSB> <pos y LSB> <pos y MSB> <vel x LSB> <vel x MSB> <vel y LSB> <vel y MSB> f7

pos: 14-bit position, 0...16383. (0,0) is the lower left corner. *vel*: signed 14-bit velocity, -8192...+8191. 0 is 00 40.

Direction is a combination of x and y velocity.

Kaoss Physics

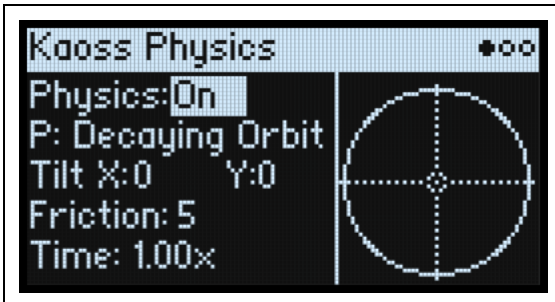

Physics (SHIFT- KAOSS)

[Off, On]

Off: The physics model is disabled, and the pad works as a simple x-y pad.

On: The physics model is enabled.

P (Kaoss Physics Preset)

[List of Presets]

Select the parameter and then either turn the **VALUE** knob or press **ENTER** to bring up the Preset Select popup, which shows all of the Kaoss Physics Presets installed on the instrument. For details on sorting and filtering the list, see “Selecting from lists” on page 4.

Tilt X

[-100...+100]

Tilts the plane from left (negative) to right (positive).

Tilt Y

[-100...+100]

Tilts the plane from down (negative) to up (positive). For instance, tilting Y downward creates “gravity” towards the bottom.

Friction

[0...100]

Controls the energy absorption as the ball travels across the surface.

Time

[0.00x...1.00x]

Slows down time. Note that 1.00 (normal speed) is the maximum; if you want to both speed up and slow down, start at a value in the middle.

Kaoss Physics Details

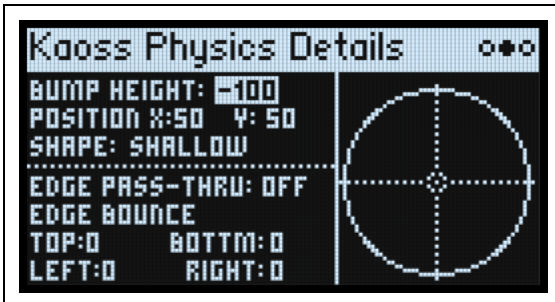

Bump Height

[-100...+100]

Positive for convex (a “hill”), negative for concave (a “hole”).

Position X

[0...50...100]

Sets the center point of the bump on the X axis. 50 is the center; 0 is the left side, and 100 is the right.

(Position) Y

[0...50...100]

Sets the center point of the bump on the Y axis. 50 is the center; 0 is the bottom, and 100 is the top.

Shape

[Gravity, Linear, Shallow, Steep]

Shape controls the slope from the edges of the surface to the center point.

Gravity: The closer to the center, the steeper the slope. With negative Bump Heights, this acts similar to gravitational attraction.

Linear: Slope is constant over the entire surface.

Shallow: Slope is steep close to the edges and more gentle in the middle, like a shallow bowl.

Steep: Slope is gentle over most of the surface and markedly stronger in the center.

Edge Pass-Thru

[Off, On]

Off: The ball bounces off of the four walls as specified below.

On: This removes the walls entirely, so that the surface wraps around to the opposite edges like a vintage arcade game.

Edge Bounce Top/Bottom/Left/Right

[-100...+100]

These four parameters control what happens when the ball hits each of the walls. They only apply if **Edge Pass-Thru** is *Off*.

Negative values slow down the ball, as if the wall was padded.

Positive values accelerate the ball, like bumpers in a pinball machine.

Kaoss Launch

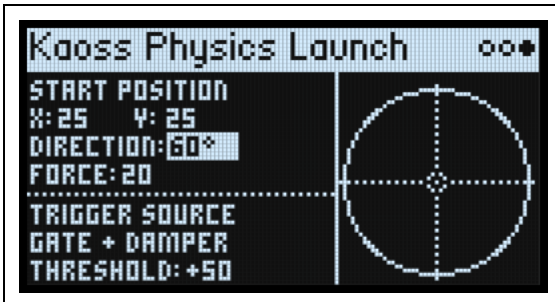

This page lets you launch the ball automatically using a trigger source. For instance, triggering via *Gate + Damper* will launch the ball whenever you play a new phrase on the keyboard; triggering via the *Kaoss Button* will launch the ball when you press the front-panel **KAOSS** button. You can control the start point, direction, and force of the launch.

Start Position X

[0...50...100]

Sets the start point of the launch on the X axis. 50 is the center; 0 is the left side, and 100 is the right.

(Start Position) Y

[0...50...100]

Sets the start point of the launch on the Y axis. 50 is the center; 0 is the bottom, and 100 is the top.

Direction

[0...360°]

This controls the angle of the launch. 0° (and 360°) is straight to the right, 90° is straight up, 180° is straight to the left, and 270° is straight down.

Force

[0...100]

This controls the initial speed of the ball.

Trigger Source

[List of modulation sources]

This selects a source to trigger the launch. Try using *Gate + Damper* or *Kaoss Button*. Note that since there is a single Kaoss Physics generator for the entire Performance, per-voice sources such as Envelopes and LFOs cannot be used as triggers.

Trigger Threshold

[-100%...+100%]

This sets the modulation level which will trigger the launch. With either *Gate + Damper* or *Kaoss Button* as the source, use a positive value of 50%.

When the threshold is *positive* (or 0), the launch triggers when passing through the threshold moving upwards. In other words, if the value has been below the **Threshold**, and then changes so that it is equal to or greater than the **Threshold**, the ball is launched.

When the threshold is *negative*, the launch triggers when passing through the threshold moving downwards. In other words, if the value has been above the **Threshold**, and then changes so that it is equal to or below than the **Threshold**, the ball is launched.

Arpeggiator

Arpeggiator

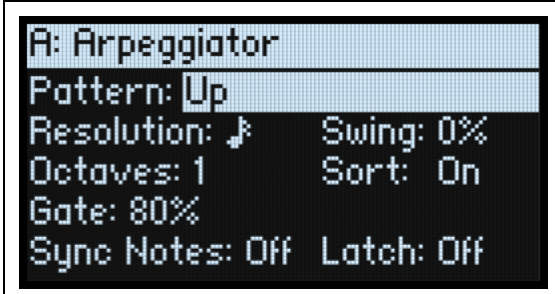

The Arpeggiator is particularly effective in conjunction with Motion Sequence Lane **Note Advance**, so that each generated note starts on a new step in the Lane. Try this with a single Timing step set to *Gate*.

Arpeggiator (ARPEGGIATOR)

[Off, On]

Turn the arpeggiator on and off via the **ARPEGGIATOR** button. To view the page without changing on/off, use **ENTER + ARPEGGIATOR**.

Pattern

[Up, Down, Alt1, Alt2, Random]

This controls the note pattern of the Arpeggiator.

Resolution

[32nd note triplet ... 1/4 note]

This controls the speed of the Arpeggiator. Try modulating this from the Mod Wheel!

Swing

[-100%...+100%]

This controls the rhythmic swing of the Arpeggiator, based on the **Resolution** above.

100%: The second rhythmic division will be pushed to the third triplet, for a full swing feel.

-100%: The second rhythmic division will be pulled to the second triplet, for a reverse-swing feel.

Octaves

[1...4]

This controls the range of the arpeggiated notes.

Sort

[Off, On]

Off: The Arpeggiator **Patterns** will be based on the order in which the notes were originally played. For instance, *Up* will play the notes in the originally played order, and *Down* will play the notes in reverse order.

On: The Arpeggiator will play notes according to the selected **Pattern**, and ignore the originally played order.

Gate

[0%... 100%]

This sets the length of the arpeggiated notes, as a percentage of the **Resolution**.

Sync Notes

[Off, On]

Off: The Arpeggiator will start to play as soon as notes are played on the keyboard, and will not necessarily synchronize to tempo Motion Sequences.

Arpeggiator

On: The Arpeggiator will synchronize to any sounding tempo Motion Sequences.

Latch

[Off, On]

Off: The Arpeggiator will only play as long as notes are being held on the keyboard (or via the damper pedal).

On: The Arpeggiator will continue to play after notes are released.

Filter

Filter

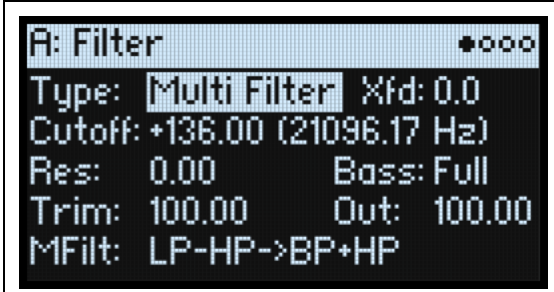

Type (FILTER TYPE)

[Polysix, MS-20 LP, MS-20 HP, 2-pole LP, 2-pole HP, 2-pole BP, 2-pole BR, 4-pole LP, 4-pole HP, 4-pole BP, 4-pole BR, Multi Filter]

Pressing the front panel **FILTER TYPE** button selects and edits the **Type** parameter. Three useful settings are available directly: the Polysix LP, the MS-20 LP, and the Multi Filter. Many more types are available by editing the on-screen parameter. If in doing so you select one of the three types listed on the front panel, the front-panel **FILTER TYPE** LEDs will update to show the selection. Selecting any other Filter Type lights the **MORE** LED. If you switch between **Types** from the front-panel button, the **MORE** position remembers the last-used “more” **Type**.

LP (Low Pass). This cuts out the parts of the sound which are **higher** than the cutoff frequency. Low Pass is the most common type of filter, and is used to make bright timbres sound darker.

HP (High Pass). This cuts out the parts of the sound which are **lower** than the cutoff frequency. You can use this to make timbres sound thinner or more buzzy.

BP (Band Pass). This cuts out all parts of the sound, both highs and lows, except for the region around the cutoff frequency. Since this filter cuts out both high and low frequencies, its effect can change dramatically depending on the cutoff setting and the oscillator’s multisample.

With low resonance settings, you can use the Band Pass filter to create telephone or vintage phonograph sounds. With higher resonance settings, it can create buzzy or nasal timbres.

BR (Band Reject). This filter type—also called a notch filter—cuts only the parts of the sound directly around the cutoff frequency. Try modulating the cutoff with an LFO to create phaser-like effects.

2-pole LP, HP, BP, and BR: These produce 12dB/octave slopes for LP and HP, and 6dB/octave for BP and BR. A classic synthesizer expander module used this type of filter.

4-pole LP, HP, BP, and BR: These produce 24dB/octave slopes for LFP and HP, and 12dB/octave for BP and BR. In comparison to 2-pole filters, these create a sharper roll-off beyond the cutoff frequency with more delicate resonance. Many classic analog synths used this general type of filter.

Multi Filter. This is a complex filter which is capable of all of the 2-pole filter types, and many more besides. See “Multi Filter,” on page 54.

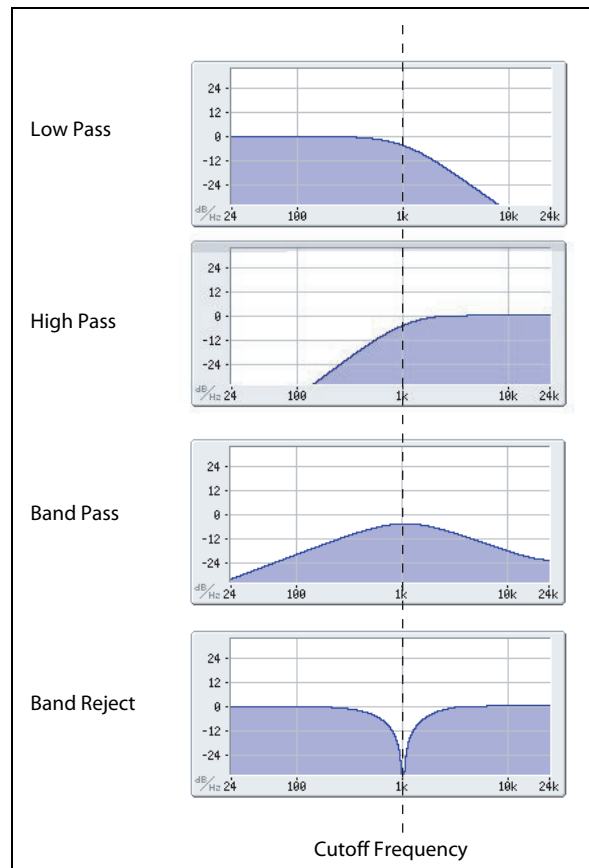

Filter

MS-20 LP and HP: These 12dB/octave, self-resonating filters lovingly recreate the distinctive timbral signature of the classic Korg MS-20. Raising **Resonance** will cause increasing amounts of saturation and overdrive, creating a more aggressive tone. Input volume can have a strong effect on this character; for more information, see “Gain” on page 53. *Polysix*: This 24dB/octave, self-resonating low-pass filter provides the strong, sweet sound of the classic Korg Polysix.

Cutoff (CUTOFF)

[-4.00 or +8.00...+136.00 or +138.00 semitones]

This controls the cutoff frequency of the filter, in semitones mapped to MIDI note numbers (60.00 = middle C). The frequency in Hz is also shown. The specific effect of the cutoff frequency will change depending on the selected **Type**, as described above. Most filter types have a range of -4.00 to +138.00, but the *MS-20 LP/HP* and *Polysix* range from +8.00 to +136.00.

Res (RESONANCE)

[0.00...100.00]

Resonance emphasizes the frequencies around the cutoff frequency, as shown in the diagram below.

When this is set to 0, there is no emphasis, and frequencies beyond the cutoff will simply diminish smoothly.

At medium settings, the resonance will alter the timbre of the filter, making it sound more nasal, or more extreme.

At very high settings, the resonance can be heard as a separate, whistling pitch.

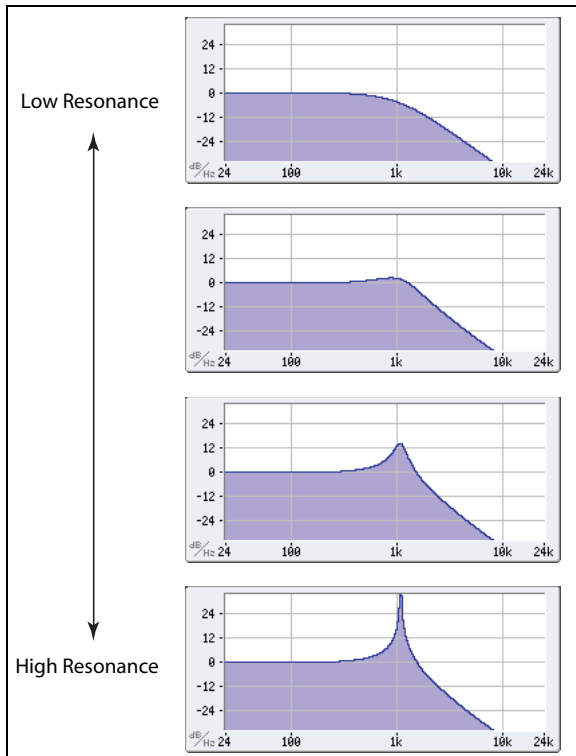

Trim

[0.00...100.00]

This adjusts the volume level at the input to the filter. If you notice that the sound is distorting, especially with high **Resonance** settings, you can turn the level down here.

Out (Output Level)

[0.00...100.00]

This controls the output level of the filter.

2-Pole LP/HP/BP/BR

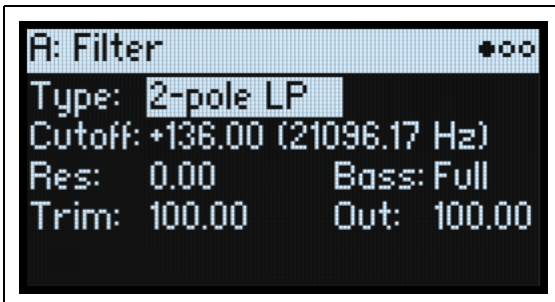

(Resonance) Bass

[Full, Tight]

This is available only when **Type** is one of the *2-pole Resonant* or *4-pole Resonant* settings, or *Multi Filter*. **Resonance Bass** controls the character of the filter resonance at low cutoff frequencies. Its effect is most noticeable with high **Resonance** settings.

Tight produces a more restrained resonance, similar to a classic, American, wood-paneled monophonic synthesizer.

Full produces a wide, boomy resonance, reminiscent of a famous five-voice American synthesizer.

4-Pole LP/HP/BP/BR

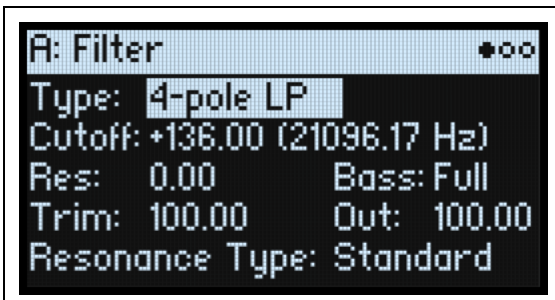

Resonance Type

[Standard, High]

Resonance Type is available only when using one of the *4-pole* filters.

Standard provides the resonance character of a typical analog 4-pole filter.

High creates a more pronounced resonance.

MS-20 LP/HP and Polysix

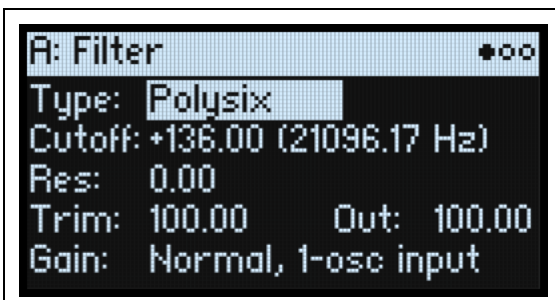

Gain

[Loud, Less Resonance; Unity, Less Resonance; Normal, 1-osc input; Normal, 2-osc input]

Gain is available only when **Type** is *MS-20 LP*, *MS-20 HP*, or *Polysix*. These filter types include saturation, which interacts with resonance. With anything other than very low resonance settings, input volume can have a strong effect on their character. The *lower* the input gain, the more headroom remains for the resonance to bloom. Use **Gain** to set the basic input level, and then fine-tune with **Trim** if desired.

Filter

Normal, 2-osc input: This is the lowest input gain. It will produce the classic resonant sounds of these filters even with two oscillators playing at full volume. If you're using the Sub Oscillator as well, and want to retain the full volume of the resonance effect, you may wish to use **Trim** to further reduce the input gain.

Normal, 1-osc input: This will produce the classic resonant sounds of these filters with a single oscillator playing at full volume. When input is louder than a single full-volume oscillator, the resonance effect will be less pronounced.

Unity, Less Resonance: Volume is unattenuated. This leaves less headroom, so resonance will be less prominent.

Loud, Less Resonance: This provides a slight volume boost on input. This makes it easy to reach saturation with the input level alone, leaving very little headroom for resonance.

Multi Filter

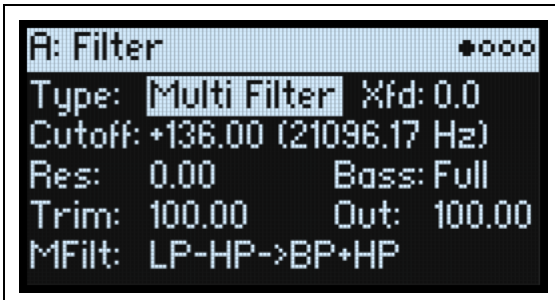

Xfd (XFADE)

[0...100]

This is available only when **Type** is *Multi Filter*. **XFADE** (crossfade) morphs between the Mode 1 and Mode 2 settings. 0 is all Mode 1, 100 is all Mode 2, and 1-99 are intermediate values between the two Modes. Control this from the front panel using **SHIFT-ENV INTENSITY**.

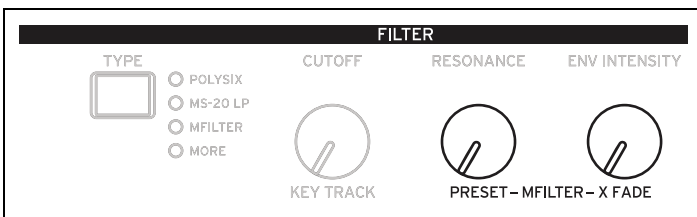

Mfilt (Multi Filter Preset) (PRESET)

[List of Presets]

This is available only when **Type** is *Multi Filter*. Presets let you quickly select from a number of useful combinations of Modes 1 and 2. Choose presets from the front panel using **SHIFT-RESONANCE**. You can also select any combination you wish on the Multi Filter page, described below.

Multi Filter

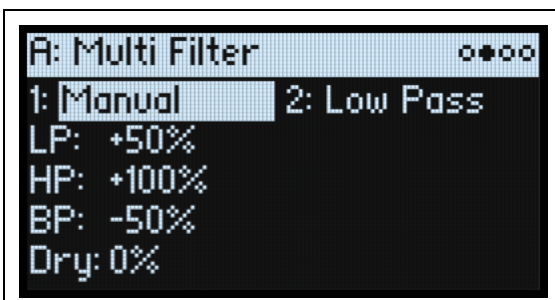

This page is available only when the Filter page **Type** is set to *Multi Filter*.

What's a Multi Filter?

Standard multimode filters generate low-pass, high-pass, and band-pass filters simultaneously—but only let you use one of them at a time. The Multi Filter gives you access to all three filter modes simultaneously, in any combination, along with the dry input signal. You can choose from a large number of preset combinations, or create your own complex filter modes using the Manual controls.

This is capable of some cool sounds in and of itself, but things really get interesting when you use **XFADE** (see “Xfd (**XFADE**)” on page 54). **XFADE** allows you to mix between two of these filter settings (**Mode 1** and **Mode 2**), using modulation sources such as envelopes, LFOs, or real-time controllers.

1 (Mode 1)

[List of filter types]

This sets the filter type for Mode 1.

Low Pass, *High Pass*, *Band Pass*, and *Band Reject* are the standard filter types. For more information, see “Filter,” on page 51.

LP+BP, *LP-BP*, *LP-HP*, *BP+HP*, *BP-HP*, *Dry+LP*, *Dry-LP*, *Dry+BP*, *Dry-BP*, *Dry+LP-HP*, *Dry+LP-BP*, *Dry+BP-LP*, *Dry+BP-HP*, *Dry+HP-LP*, *Dry+HP-BP*, *LP+HP+BP*: These combine two or more filters at equal volumes. *Dry* is the un-filtered input signal. The minus sign (“-”) indicates when the phase of a filter is reversed.

All On uses the Low Pass, High Pass, Band Pass, and Dry signals at equal volumes.

Manual lets you create your own mix of the filters; an additional four parameters will appear. For more information, see “Manual,” below.

2 (Mode 2)

Mode 2 has the same selections as Mode 1.

Manual

When Mode is set to *Manual*, these parameters let you create your own mix of the filters.

You may wonder why Band Reject is not included here. This is because it's not a filter mode per se. Instead, it's created by equal amounts of High Pass and Low Pass. Try it and see!

LP (Lowpass), HP (Highpass), BP (Bandpass), Dry

[-100%...+100%]

These set the volume of the Lowpass, Highpass, Bandpass, and Dry signals, respectively. Negative values invert the phase.

Filter Mod

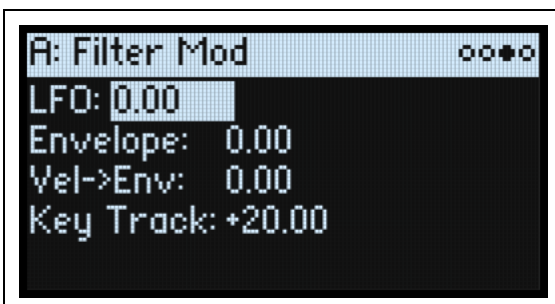

These four parameters control the default modulation routings for Filter Cutoff. You can create additional routings as desired; for more information, see “Adding Modulation Routings” on page 64.

LFO (INTENSITY)

[-142.00...+142.00]

This sets the amount of modulation from the Filter LFO, in semitones.

Filter

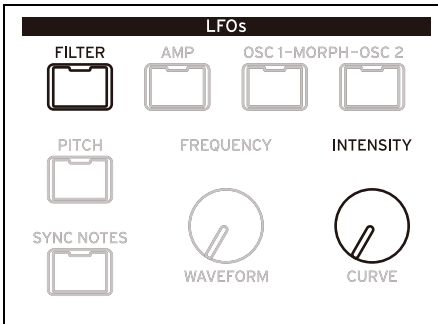

Envelope (ENV INTENSITY)

[-142.00...+142.00]

This sets the amount of modulation from the Filter Envelope, in semitones.

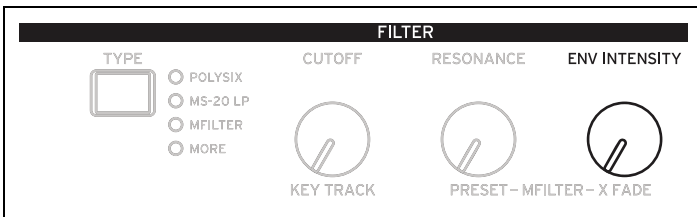

Vel->Env (VELOCITY)

[-142.00...+142.00]

This lets you use velocity to scale the amount of the Filter Envelope applied to Filter Freq, in semitones.

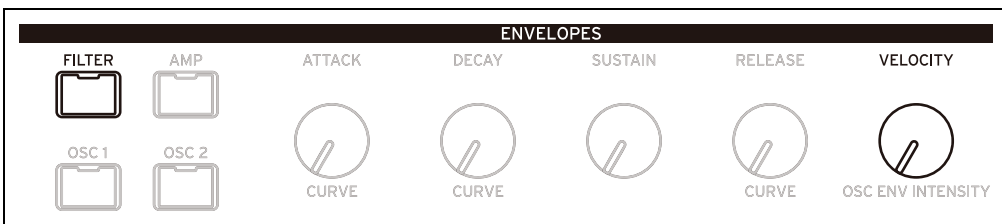

Key Track (SHIFT-CUTOFF)

[-142.00...+142.00]

This controls how much the Key Track will affect the Cutoff frequency. The overall effect of the Keyboard Track is a combination of this value and the overall Keyboard Track shape.

With positive values (+), the effect will be in the direction specified by keyboard tracking; if the Slope goes up, the Cutoff will **increase**.

With negative values (-), the effect will be in the opposite direction; if the Slope goes up, the Cutoff will **decrease**.

To create one-octave-per-octave key tracking (useful when creating pitch through filter resonance):

1. Set the Key Track amount to **+60.00 semitones**.
2. In Filter Key Track, set Low and Low-Mid Slopes to **-1.00**, and Mid-High and High Slopes to **+1.00**.

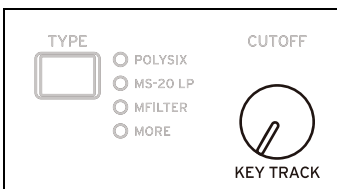

Filter Key Track



Most acoustic instruments get brighter as you play higher pitches. At its most basic, keyboard tracking re-creates this effect by increasing the cutoff frequency of a lowpass filter as you play higher on the keyboard. Usually, some amount of key tracking is necessary in order to make the timbre consistent across the entire range.

The modwave keyboard tracking can also be much more complex, since it allows you to create different rates of change over up to four different parts of the keyboard. For instance, you can:

- Make the filter cutoff increase very quickly over the middle of the keyboard, and then open more slowly—or not at all—in the higher octaves.
- Make the cutoff increase as you play *lower* on the keyboard.
- Create abrupt changes at certain keys, for split-like effects.

How Key Track works: Keys and Slopes

The keyboard tracking works by creating four ramps, or slopes, between five keys on the keyboard. The bottom and top keys are fixed at the bottom and top of the MIDI range, respectively. You can set the other three keys—named **Low**, **Mid**, and **High**—to be anywhere in between.

The four Slope values control the rate of change between each pair of keys. For instance, if the **Low-Mid Slope** is set to 0, the value will stay the same between the **Low Key** and the **Mid Key**.

You can think of the resulting shape as being like two folding doors attached to a hinge in the center. At the **Mid Key** (the main hinge), the keyboard tracking has no effect. The two folding doors swing out from this center point to create changes in the higher and lower ranges of the keyboard.

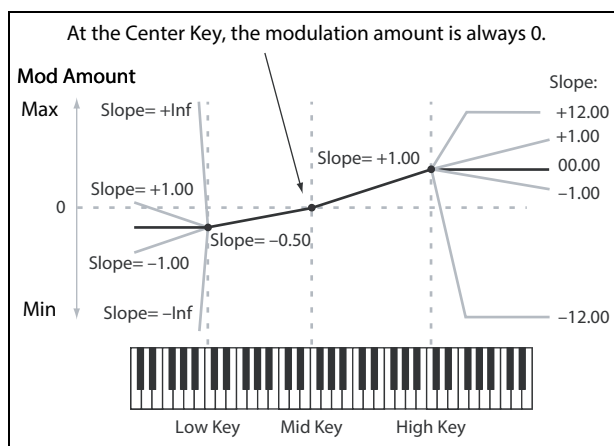

Slope

Positive slope values mean that the keyboard tracking output increases as you play farther from the Mid Key; negative slope values mean that it decreases. Because of this, the meaning of positive and negative slopes changes depending on whether the slope is to the left or right of the **Mid Key**.

Low and Low-Mid: negative slopes make the output go down as you play *lower* on the keyboard, and positive slopes make the output go up.

Mid-High and High: negative slopes make the output go down as you play *higher* on the keyboard, and positive slopes make the output go up.

The table below shows how the slopes affect the modulation output:

Slope value	Modulation change
-Inf	0 to minimum in 1 half-step
-10.00	0 to minimum in 6 semitones
-5.00	0 to minimum in 1 octave
-1.00	0 to minimum in 5 octaves

Filter

Slope value	Modulation change
0	no change
+1.00	0 to maximum in 5 octaves
+5.00	0 to maximum in 1 octave
+10.00	0 to maximum in 6 semitones
+Inf	0 to maximum in 1 half-step

The final effect of Key Track is a combination of the Key Track shape and the modulation intensity. With greater Slope values, the Key Track shape can max out fairly quickly. Because of this, if you want a more intense effect, it's best to increase the modulation intensity first, rather than increasing the Slope.

+Inf and -Inf slopes

+Inf and -Inf are special settings which create abrupt changes for split-like effects. When a slope is set to +Inf or -Inf, the keyboard tracking will go to its extreme highest or lowest value over the span of a single key.

Note: if you set the **Mid-High Slope** to +Inf or -Inf, the **High Slope** will have no effect. Similarly, if you set the **Low-Mid Slope** to +Inf or -Inf, the **Low Slope** will have no effect.

Low Slope

[-Inf, -12.00...+12.00, +Inf]

This sets the slope between the bottom of the MIDI note range and the Low key. For normal key track, use negative values. -1.00 is the default.

(Low) Key

[C-1...G9]

This sets the breakpoint note between the two lower slopes—the “hinge” of the lower door.

 The Low Key can't be set above the Mid Key.

Low-Mid Slope

[-Inf, -12.00...+12.00, +Inf]

This sets the slope between the Low and Mid keys. For normal key track, use negative values. -1.00 is the default.

Mid Key

[C-1...G9]

This sets the center of the keyboard tracking—the main “hinge.” When this key is played, the Key Track output is 0.

 The Mid Key can't be set below the Low Key, or above the High Key.

Mid-High Slope

[-Inf, -12.00...+12.00, +Inf]

This sets the slope between the Mid and High keys. For normal key track, use positive values. +1.00 is the default.

High Key

[C-1...G9]

This sets the breakpoint note between the two higher slopes—the “hinge” of the upper door.

 The High Key can't be set below the Mid Key.

(High) Slope

[-Inf, -12.00...+12.00, +Inf]

This sets the slope between the High key and the top of the MIDI note range. For normal key track, use positive values. +1.00 is the default.

Pitch

Osc Pitch

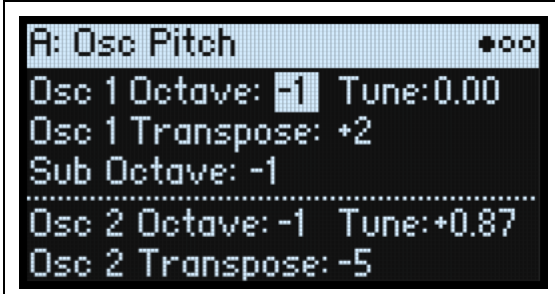

Osc 1

Osc 1 Octave (SHIFT-POSITION)

[-2...0...+2]

This sets Oscillator 1's basic pitch, in octaves. The default is 0.

Tune (SHIFT-A/B BLEND)

[-12.00...+12.00]

This adjusts Oscillator 1's pitch in increments of 1/100 of a semitone, over a range of ± 1 octave.

Osc 1 Transpose

[-12...+12]

This adjusts Oscillator 1's pitch in semitones, over a range of ± 1 octave. When the Oscillator is set to Sample, this also affects the index into the Multisample map, potentially changing the sample selection—similar to transposing the entire keyboard.

Sub Octave

[-2, -1, 0]

This applies only when **Sub/Noise Type** (on the Mixer & Sub Osc page) is set to *Square* or *Triangle*. It sets the pitch offset from Oscillator 1, in octaves. The default is -1. This parameter is duplicated on the Mixer & Sub Osc page.

Osc 2

Osc 2 Octave (SHIFT-POSITION)

[-2...0...+2]

Tune (SHIFT-A/B BLEND)

[-12.00...+12.00]

Osc 2 Transpose

[-12...+12]

See the descriptions for Osc 1, above.

Common Pitch



These settings apply to the entire Program, including Osc 1/2 and the Sub Oscillator. Press **PITCH** to go to this page.

Octave

[-2...0...+2]

This sets the basic pitch, in octaves. The default is 0.

Transpose

[-12...+12]

This adjusts the pitch in semitones, over a range of ± 1 octave. If Oscillators are set to Sample mode, this also affects the index into the Multisample map, potentially changing the sample selection—similar to transposing the entire keyboard.

Tune

[-12.00...+12.00]

This adjusts the pitch in 1/100 of a semitone, over a range of ± 1 octave.

Slope

[-1.0...+2.0]

This controls how pitch tracks the keyboard. Normally, it should be set to the default of $+1.0$.

Positive (+) values cause the pitch to rise as you play higher on the keyboard, and negative (–) values cause the pitch to *fall* as you play higher on the keyboard.

When **Slope** is 0, playing different notes on the keyboard won't change the pitch at all; it will be as if you're always playing C4.

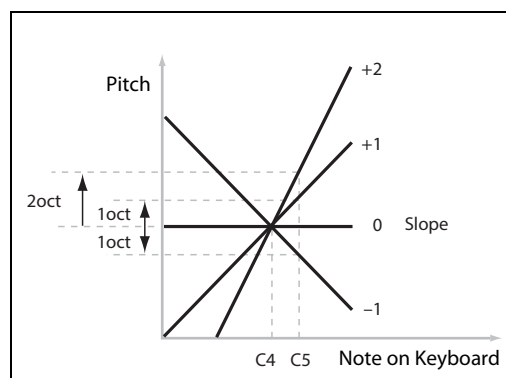

Portamento

[Off, On]

Portamento lets the pitch glide smoothly between notes, instead of changing abruptly.

On: Turns on **Portamento**, so that pitch glides smoothly between notes.

Off: Turns off **Portamento**. This is the default.

Fingered

[Off, On]

Fingered applies only when **Portamento** is *On*.

On: Playing legato will turn on Portamento, and playing detached will turn it off again.

Off: Legato/detached playing will not affect Portamento.

Type

[Constant Rate, Constant Time]

Constant Rate: Portamento will always take the same amount of time to glide a given distance in pitch—for instance, one second per octave. Put another way, gliding several octaves will take much longer than gliding a half-step.

Pitch

Constant Time: Portamento will always take the same amount of time to glide from one note to another, regardless of the difference in pitch. This is especially useful when playing chords, since it ensures that each note in the chord will end its glide at the same time.

Time

[0.0000...50.0000 secs or secs/octave]

This controls the portamento time. If **Type** is set to *Constant Rate*, the units are secs/octave (seconds per octave). If **Type** is set to *Constant Time*, the units are simply secs (seconds).

Pitch Mod



These settings apply to the entire Program, including Osc 1/2 and the Sub Oscillator. To modulate the pitches of individual Oscillators, use the Osc Pitch page instead.

LFO (INTENSITY)

[-144.00...+144.00]

This controls the initial effect of the Pitch LFO on the pitch, in semitones.

Pitch Bend Up

[-60...+60]

This sets the maximum amount of pitch bend, in semitones, when you move the wheel above the center point. For normal pitch bend, set this to a positive value.

Pitch Bend Down

[-60...+60]

This sets the maximum amount of pitch bend, in semitones, when you move wheel below the center point. For normal pitch bend, set this to a negative value.

Amp

Amp

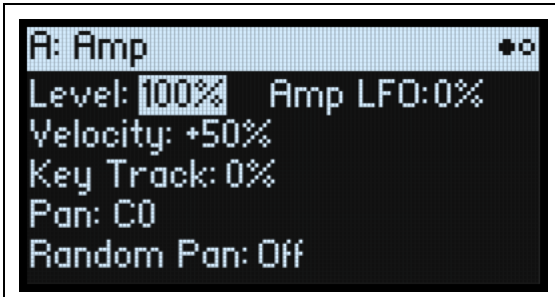

Press **AMP** to go to this page.

Notes on Amp Modulation

Amp modulation scales the Amp **Level** and Amp Envelope. The final volume is determined by multiplying these by any additional modulation sources, with an upper limit of 2x the original level. If the original level is low, the maximum modulated volume will also be low.

Tip: To start with a low level (or silence) and then use modulation to raise the level to maximum, use the Filter **Output Level** instead.

Level

[0%...100%]

This sets the basic volume of the Program, optimized for per-voice modulation. For adjusting the volumes of Programs within a Performance, it's better to use Layer **Volume** instead.

Amp LFO (INTENSITY)

[-100%...+100%]

This controls the amount of modulation from the Amp LFO.

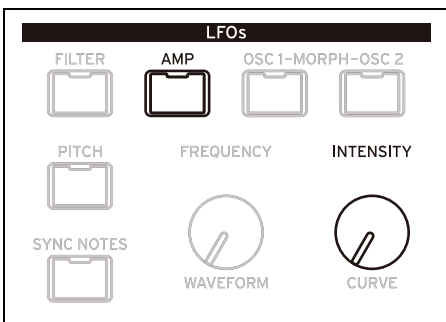

Velocity (VELOCITY)

[-100%...+100%]

With *positive* (+) values, the volume increases as you play harder.

With *negative* (-) values, the volume decreases as you play harder.

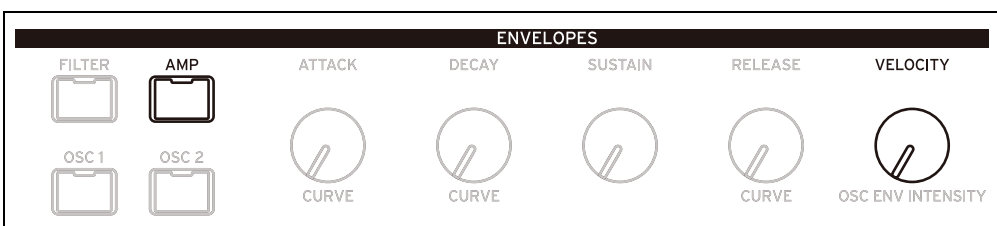

Amp

Key Track

[−100%...+100%]

This adjusts the intensity of Key Track’s effect on the level.

Pan

[L100...L1, C0, R1...R100]

This sets the left-right pan. Note that this can be modulated per voice!

Random Pan

[Off, On]

Off: The normal pan controls, above, apply.

On: Each voice will be randomly panned across the stereo field. All other pan controls are disabled.

Amp Key Track



Keyboard tracking (“Key Track”) changes the volume as you play up and down the keyboard. This may be used to make the volume more consistent, or to create special effects.

The modwave’s Key Track can be fairly complex, if desired. For instance, you can:

- Make the volume increase very quickly over the middle of the keyboard, and then increase more slowly—or not at all—in the higher octaves.
- Create abrupt changes at specific keys.

You can also use Amp Key Track as a general-purpose modulation source, just like the envelopes and LFOs.

For general details on how Key Track works, see “Filter Key Track” on page 57.

Differences from Filter Keyboard Track

Amp Key Track’s minimum value produces silence, while its maximum value provides a 2x boost in gain. This means that unlike Filter Key Track, Amp Key Track’s negative **Slopes** are steeper than positive **Slopes**.

Key Track amount	Slope	Change in level
100%	-Inf	Silent in one half-step
	-12.00	Silent in five semitones
	-5.00	Silent in one octave
	-1.00	Silent in five octaves
	00	no change
	+1.00	2x in five octaves
	+5.00	2x in one octave
	+12.00	2x in five semitones
	+Inf	2x in one half-step

Modulation

Using Modulation

Modulation Overview

Most front-panel controls and on-screen parameters can be modulated. You can also create multiple modulation routings to the same destination. Each modulation routing includes a primary modulation source, an intensity, and a secondary modulation source; the three are multiplied together to create the modulation amount. Once a modulation routing is created, you can change either of the sources, but you cannot change the destination.

Adding Modulation Routings

To add a new Modulation routing:

1. In the display, select the parameter that you'd like to modulate. (If you want to modulate a knob, you can skip this step.)
2. Hold **MOD** and press **>**.

The Add New Modulation popup appears.

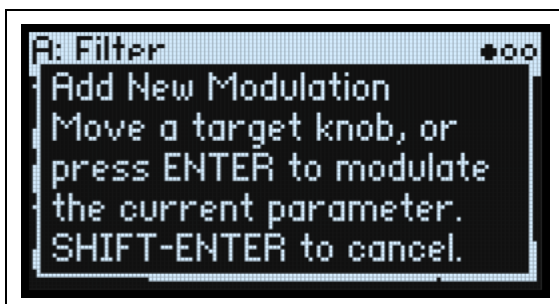

3. To select the modulation destination, move its front-panel control (e.g., **CUTOFF**), or press **ENTER** to select the parameter from step 1.

Note: If the selected parameter cannot be modulated, a message will appear on the display and then the popup will close.

4. To select the modulation source, move a controller (e.g. **WHEEL 1**) or a **MOD KNOB**, play a note (for Velocity), press a button for one of the LFOs, Envelopes, or Step Seq Lanes, or send a MIDI CC.

Alternatively, if you want to use a mod source which can't be selected from the front panel (such as Exponential Velocity or Mod Processors), press **ENTER** and manually select the mod source in the following screen.

If the message "Chan Src Only" appears, the parameter cannot be modulated from per-voice sources such as LFOs, envelopes, Step Seq Lanes, and Key Track. Choose a different modulation source.

5. Press **ENTER** to create the mod routing, or **SHIFT-ENTER** to cancel.

The Mods page appears, showing the new routing.

6. Set the Intensity as desired.

The maximum Intensity is typically +/- the full range of the parameter, so that regardless of the programmed value, modulation can always reach the minimum or maximum values.

7. Optionally, assign a second modulator as the Int Mod Source (Intensity Mod Source), whose value multiplies that of the main Source.

For example, you could route Step Seq Lane B to Multi Filter **Crossfade**, with the overall amount of the step sequencer modulated by the Osc 1 LFO.

Filter/Osc Env Intensities, LFO Intensities, and Key Track Intensities

Modulation works slightly differently for these "Intensity" parameters. When you select them as a destination:

- The modulation destination is set to the main parameter: Filter Cutoff, Amp Level, Osc 1 Position, etc.
- The Source is set to the Envelope, LFO, or Key Track
- The Intensity Mod Source is set to the selected modulation source (as selected in step 4, above).

Filter and Osc 1/2 Env Velocity Intensity

Filter and Osc 1/2 Envelope Velocity Intensity cannot themselves be modulated.

Viewing and Editing Modulations

All user-created modulation routings can be viewed and edited on the Mods page.

Note: Built-in modulation routings, such as Filter Envelope modulation of Filter Cutoff or Osc 1 LFO modulation of Osc 1 Morph, are not shown here.

To view modulation routings:

1. Press **MOD**. The screen will change to the Mods page, which displays all of the modulation routings in the current Program in a scrolling list.

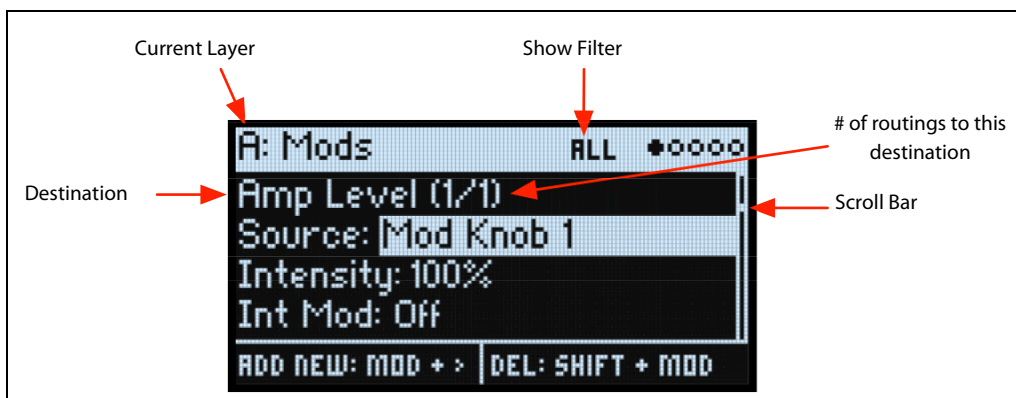

2. Hold **ENTER** and press **<** or **>** to scroll through the different routings.

Alternatively, you can cursor through each parameter, one by one; cursoring right from Int Mod Src goes to the Source parameter of the next routing.

A scroll-bar on the right side of the display shows the current location in the list.

When you see the modulation routing that you'd like to edit:

3. Use **<** and **>** to select the Source, Intensity, and Int Mod Src (Intensity Mod Source) parameters.
4. Edit the Intensity as desired using the **VALUE** knob.
5. To change the Source or Int Mod Src, select the parameter and then either turn **VALUE** or press **ENTER**. The Modulation Select popup appears.

In the Modulation Select popup, the modulation sources are organized into five groups: Controllers, Mod Knobs, Generators, CC +, and CC +/- . The groups are shown in the left column, and the modulation sources are shown in the right column.

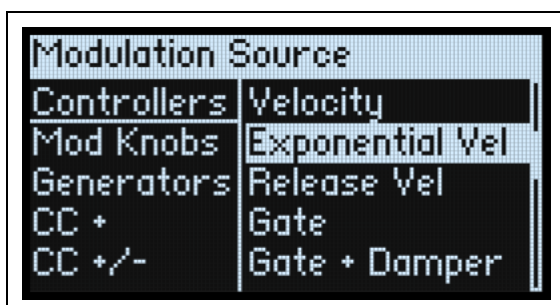

6. Use **<** and **>** to move between the columns, and **VALUE** to select items in the lists. Alternatively—and faster!—most modulation sources can be selected by pressing their associated front-panel button (for Envelopes, LFOs, and the Seq Lanes), or by holding down **ENTER** and moving a controller (such as a Mod Knob, wheel, or the Kaoss pad), playing a note on the keyboard (for Velocity), or sending MIDI data.

For information on the individual modulation sources, see “Modulation Sources” on page 67.

7. Press **ENTER** to confirm and exit the popup.

Filtering the modulation list

The list of modulations can be long. To view only the modulation routings related to a specific controller or section of the synth, use the Show parameter on the Modulation List Info page. As a shortcut to open this parameter's popup from anywhere in the UI, hold **MOD** and press **<**, as described below:

1. Hold **MOD** and press **<**.

The Show In Mod List dialog appears.

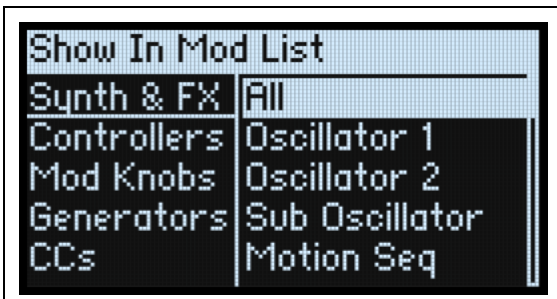

2. Press **AMP**, **PITCH**, **FILTER TYPE**, **WAVE SELECT**, or an Envelope, LFO, or Effect button; press a Lane button (pressing **SHIFT** is not required for Lane selection here); move a **MOD KNOB**; hold **ENTER** and move a controller or play a note on the keyboard (for Velocity); or send a MIDI message. Use the on-screen list for other selections, such as Key Track or Mod Processors.

Note: moving a knob in this popup will not edit the knob's parameter.

3. Press **ENTER** to confirm, close the popup, and return to the Mods page. Alternatively, to exit without making a change, hold **SHIFT** and press **ENTER**.

The Show setting is included in the top line of the display: ALL, FILTER, SHAPE LANE, etc. The list will be filtered to show only the matching items—notice how much bigger the scroll-bar thumb is in the filtered list below, indicating that there are only a few items in the list.

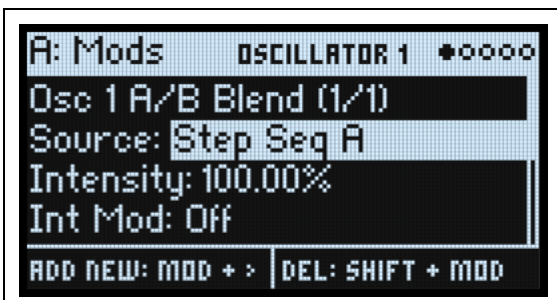

To clear the Show setting and show all modulations:

1. Press **MOD** in the Show In Mod List dialog, or set Show to All.

Deleting a modulation routing

To delete the currently shown modulation routing:

1. Hold **SHIFT** and press **MOD**.

A confirmation message will appear, asking if you want to delete the modulation routing.

2. Press **ENTER** to confirm, or any other key to cancel.

Mod Knobs

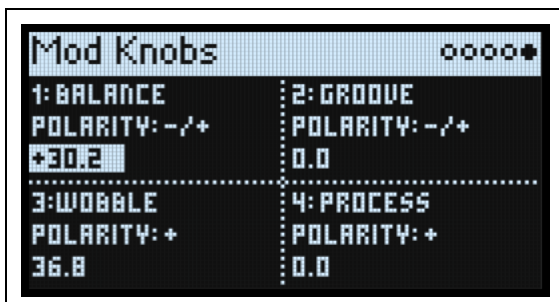

You can use the Mod Knobs in real-time performance, and also save the results as new sounds. The names and values are shown on the main PERFORM screen. The values are stored, and can themselves be modulated by the wheels, Kaoss Physics, and MIDI CCs. The Mod Knobs can control either or both Layers at once. Each knob sends and receives a MIDI CC; see “MIDI CC Assign” on page 94.

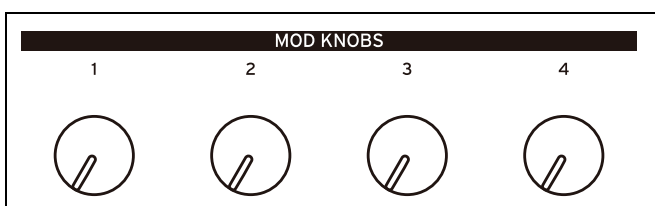

(Name)

The Mod Knobs can be named; there’s room for about 12 characters on the main Perform page.

To edit the name:

1. Select the name parameter.
2. Press **ENTER**.

The Name page appears. For more information, see “Editing names” on page 15.

Polarity

[+, -/+]

Each Mod Knob can be either unipolar (+) or bipolar (+/-).

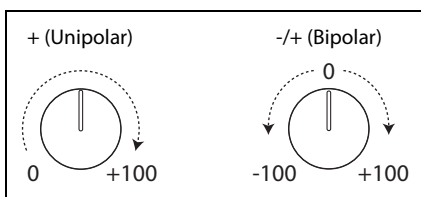

(Value)

[-100.0...+100.0]

This is the current value of the Mod Knob. When Polarity is +, values are positive only.

Modulation Sources

Controllers

Off

This means that no modulation source is selected.

Mod Wheel CC 1

This is the built-in Mod Wheel (unipolar MIDI CC#1).

Modulation

Kaoss Bttn CC 12

This is the front-panel **KAOSS** button (unipolar MIDI CC#12).

Damper CC 64

This is the damper or sustain pedal (unipolar MIDI CC#64).

Pitch Bend

This is the Pitch Bend wheel (MIDI Pitch Bend).

Velocity

This is the note-on velocity, representing how hard the note is played on the keyboard.

Exponential Velocity

This is MIDI note-on velocity through an exponential curve. Low velocities won't have very much effect, and the differences between lower velocities won't be very noticeable. On the other hand, high velocities produce increasingly greater effects, and the differences between higher velocities will be more pronounced.

Release Velocity

This is the note-off velocity, representing how quickly the note is released from the keyboard.

Gate and Gate+Damper

Gate is triggered by a new note after all notes have been released, such as at the beginning of a phrase. Gate+Damper is similar, except that it is triggered by a new note-on after all notes and the damper are released.

Note-On Trig and NoteTrig+Damp

Note-On Trig is similar to Gate, but it triggers with every new note-on, even in the middle of a legato phrase.

NoteTrig+Damp includes the damper pedal in the equation, as shown in the diagram below.

Gate, Gate+Damper, Note-On Trig, and NoteTrig+Damp

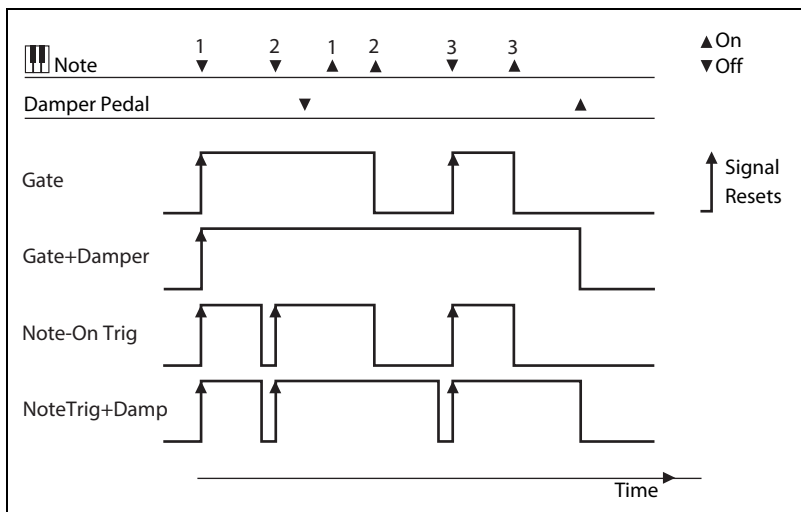

Note Number

This provides simple key tracking, going from minimum at MIDI note 0 to maximum at MIDI note 127.

Aftertouch and Poly Aftertouch

These receive Aftertouch and Poly Aftertouch via MIDI.

Note: the modwave keyboard itself does not generate aftertouch.

Kaoss X

Kaoss X is the horizontal position of the Kaoss ball: negative to the left of center, 0 in the middle, and positive to the right.

Kaoss Y

Kaoss Y is the vertical position of the Kaoss Ball: negative below the center, 0 in the middle, and positive above the center.

Modulation

Kaoss Distance

Kaoss Distance is the distance from the center, which is always positive.

Kaoss Angle

Kaoss Angle is the current angle of the ball's trajectory. This is most interesting when the ball is on a curved path such as an orbit, since the angle will be constantly changing.

Mod Knobs

This section of the list contains the 4 Mod Knobs.

Generators

Filter/Amp/Osc 1/Osc 2 Envelope

These are the four ADSR envelopes.

Filter/Amp/Osc 1/Osc 2/Pitch LFO

These are the five LFOs.

Filter/Amp Key Track

These are the Key Track generators from the Filter and Amp, respectively.

Mod Process 1/2

These are the two Mod Processors.

Step Pulse

This generates a brief trigger pulse at the start of each Sequence Step.

Step Seq A-D

These are the outputs of the four Sequence Lanes.

Tempo

This lets you use the system tempo as a modulation source. 120 is the center, for a value of 0; 60BPM is -100, and 240BPM is +100 (the value continues to increase up to 300BPM). Note that this is different from tempo synchronization; for that purpose, use the dedicated Tempo functions for the LFOs and Motion Sequence.

Program/Performance Note Count and Program/Performance Voice Count

These use the number of notes played on the keyboard, or the number of voices being played by the synth engine, as modulation sources. The Performance variations count all notes or voices in the Performance, while the Program variations only include those in the current Program.

# Notes/Voices	Resulting value
1	0.0
2	0.01
3	0.02
...	...
101	1.0

Poly Legato

When you play a legato phrase, the first note of that phrase (and notes within 30 msec of the first note) has a Poly Legato value of 0.0. Subsequent notes in the phrase have a Poly Legato value of 1.0.

CC +

This is a list of all of the MIDI CCs, interpreted as unipolar signals. MIDI values 0-127 are zero to maximum modulation.

CC +/-

This is a list of all of the MIDI CCs, interpreted as bipolar signals. MIDI value 64 is 0; values below 64 produce negative modulation, and values above 64 produce positive modulation.

Envelopes

Filter/Amp/Osc 1/Osc 2 Envelope

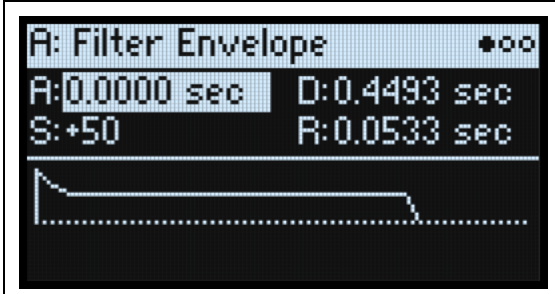

A (Attack Time) (ATTACK)

[0.0000...90.0000 seconds]

This sets how long the envelope takes to rise to the peak level.

D (Decay Time) (DECAY)

[0.0000...90.0000 seconds]

This sets how long it takes to settle from the peak to the **Sustain** level.

S (Sustain Level) (SUSTAIN)

[-100...+100 (Filter, Osc 1/2) or 0...+100 (Amp)]

This sets the level at the end of the **Decay** time. Once it reaches the **Sustain** level, the envelope will stay there until note-off, unless it is restarted via the **Trigger Source**. The Filter and Osc 1/2 Envelopes can have either positive or negative **Sustain** levels, while the Amp Envelope has only positive **Sustain** levels.

R (Release Time) (RELEASE)

[0.0000...90.0000 seconds]

This sets how long it takes the envelope to fall to 0 after releasing a note.

Filter/Amp/Osc 1/Osc 2 Envelope Curve

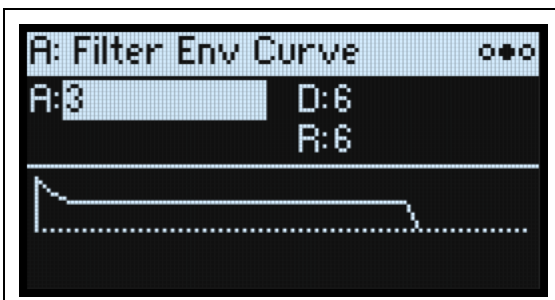

Often, envelopes are pictured as being made out of straight lines. In actuality, they are more likely to be made out of curves.

In other words, each segment's level will change quickly at first, and then slow down as it approaches the next point. When controlling natural aspects of sound such as volume, brightness, and pitch, this tends to sound better than straight, linear segments. (See note below regarding Wavetable modulation.)

Classic analog synth envelopes made these curved shapes naturally. The modwave goes a step further than vintage synths, however, and lets you control the amount of curvature separately for each envelope segment.

Envelopes

When you change the curvature, the envelope times remain the same. However, greater curvatures will tend to *sound* faster, because the value changes more quickly at the beginning.

Different Curve settings for up and down

Generally, upwards segments use different **Curve** settings than downward segments. For instance, a **Curve** of 3 often works well for upward segments, such as **Attack**. On the other hand, a **Curve** of 6 or more is often better for downward segments, such as **Decay** and **Release**.

Envelope Curve

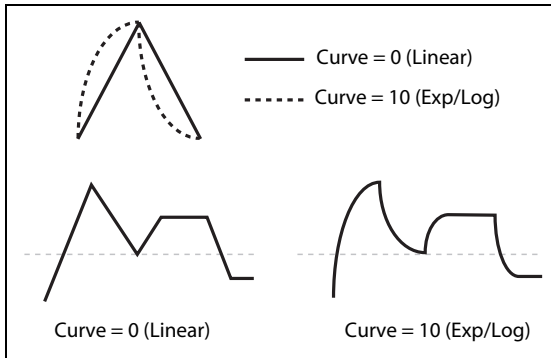

Curvature and Wavetable Position

When using the Osc 1/2 Envelopes to modulate **Position**, curvature is a matter of taste, and results will vary depending on the contents of the Wavetable. A **Curve** of 0 (*linear*) sweeps through the waveforms evenly, with equal time for each. A **Curve** of 10 (*exp/log*) sweeps through the waveforms quickly at the start of the envelope segment, and much more slowly at the end of the segment. By default, the Osc 1/2 Envelopes use 0 (*linear*) for all segments.

A (Attack), D (Decay), R (Release) (CURVE)

[0 (*linear*), 1...9, 10 (*exp/log*)]

These set the curvatures of the **Attack**, **Decay**, and **Release** segments, respectively.

Filter/Amp/Osc 1/Osc 2 Envelope Trigger

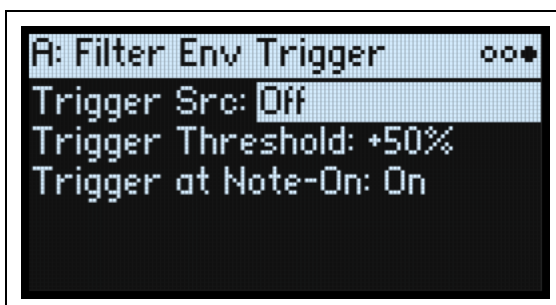

Trigger Src (Trigger Source)

[List of modulation sources]

This selects a source to start the envelope, or re-start it if it is already playing. For instance, you can use a tempo-synced LFO to trigger the envelope in a repeating rhythm.

Envelopes started or re-started by the **Trigger Source** work slightly differently from normal. The **Decay** always takes its full time, even if **Sustain** is at maximum; in this case, it acts as a hold time. Following the **Decay** time, the envelope goes to 0 over the **Release** time, even if the note is still being held.

Trigger Threshold

[-100%...+100%]

This sets the modulation level which will trigger the envelope. Among other things, you can use this to adjust the exact point in an LFO's phase at which the envelope will be reset, effectively controlling its "groove" against other rhythmic effects.

Envelopes

When the threshold is *positive* (or 0), the envelope resets when passing through the threshold moving upwards. In other words, if the value has been below the **Threshold**, and then changes so that it is equal to or greater than the **Threshold**, the envelope resets.

When the threshold is *negative*, the envelope resets when passing through the threshold moving downwards. In other words, if the value has been above the **Threshold**, and then changes so that it is equal to or below than the **Threshold**, the envelope resets.

Note: modulation sources may not always reliably reach the extreme values of +100 or -100. This can happen due to smoothing, or with LFOs when using certain shapes and faster speeds. If this is the case, **Thresholds** of +100 or -100 will cause inconsistent behavior. To avoid this issue, reduce the **Threshold** until the Envelope resets consistently.

Trigger at Note-On

[Off, On]

Trigger at Note-On is available for the Filter, Osc 1, and Osc 2 Envelopes. The Amp Envelope always triggers at note-on.

On: The envelope will start automatically at note-on. This is the default.

Off: The envelope will only start via the **Trigger Source**.

Note: The **Trigger Source's** value at note-on can cause the envelope to trigger instantly. If the **Threshold** is *positive* or 0, this will happen if the value is at or above the **Threshold**; if the **Threshold** is *negative*, this will happen if the value is at or below the **Threshold**.

LFOs

Filter/Amp/Pitch/Osc 1/Osc 2 LFO

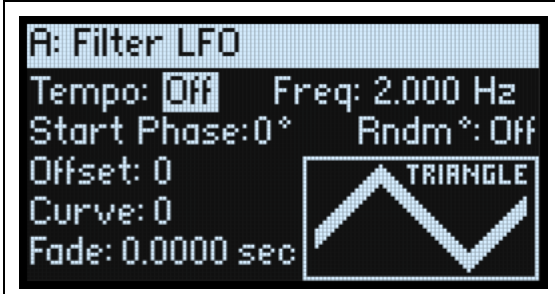

The five LFOs—Filter, Amp, Pitch, Osc 1, and Osc 2—all work identically.

Tempo

[Off, On]

On: The LFO synchronizes to the system tempo, with its speed controlled by **Base Note** and **Multiply**.

Off: The LFO speed is controlled by the **Frequency** parameter, in Hz.

Base Note (FREQUENCY)

[List of rhythmic values]

If **Tempo** is *On*, this sets the basic speed of the LFO. The values range from a 32nd note to a double breve (four whole notes), including dotted notes and triplets.

x (Multiply Base Note by...)

[1...32]

If **Tempo** is *On*, this multiplies the length of the **Base Note**. For instance, if the **Base Note** is set to a sixteenth note, and **Times** is set to 3, the LFO will cycle over a dotted eighth note.

Frequency (FREQUENCY)

[0.001...32.000 Hz]

If **Tempo** is *Off*, the LFO speed is set in Hz.

Waveform (WAVEFORM)

[Triangle...Random6 (Continuous)]

Most of the waveforms are self-explanatory, but a few will benefit from more details:

GTR (*Guitar*) is intended for guitar vibrato. It is positive-only, so that when used for pitch, it only bends upwards.

RND 1 (*Random 1*) generates traditional sample and hold waveforms: random level changes with steady timing.

RND 2 (*Random 2*) randomizes both levels and timing.

RND 3 (*Random 3*) generates a pulse wave with random timing.

RND 4-6 are smoothed versions of *Random 1-3*, with slopes instead of steps. Use them to create gentler random variations.

LFOs

LFO Waveforms

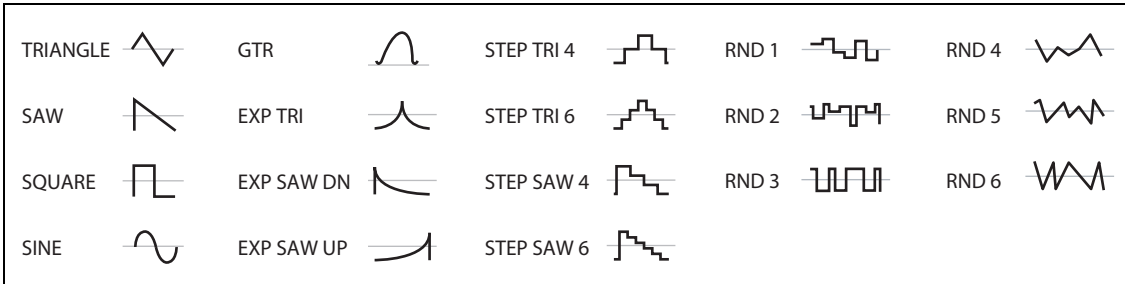

Start Phase

[−180...+180]

This controls the phase of the waveform at the start of the note. If **Random Start Phase** is *On*, or if one of the Random waveforms is selected, this parameter is not shown.

Rndm° (Random Start Phase)

[Off, On]

When **Random Start Phase** is *On*, the LFO will start at a different, random phase every time. If one of the Random waveforms is selected, this parameter is not shown.

Offset

[−100...+100]

By default, almost all of the LFO waveforms are centered around 0, and then swing all the way from -100 to +100. **Offset** lets you shift the LFO up and down, so that—for instance—it's centered on 50, and then swings from -50 to +150.

For example, let's say that you're using an LFO for vibrato. If **Offset** is 0, the vibrato will be centered on the note's original pitch, bending it both up and down.

If **Offset** is +100, on the other hand, the vibrato will only raise the pitch above the original note.

Offset settings and pitch change produced by vibrato

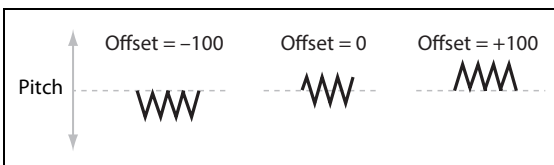

The one exception to this is the *Guitar* waveform, which is designed to emulate bending a string on a guitar—so that the pitch only goes up, and not down. Because of this, the waveform is centered on 50, and not on 0. Of course, you can always use a negative **Offset** to shift it back down below 0 again!

Offset affects the signal *after* the **Shape** function, as shown below:

LFO Signal Flow

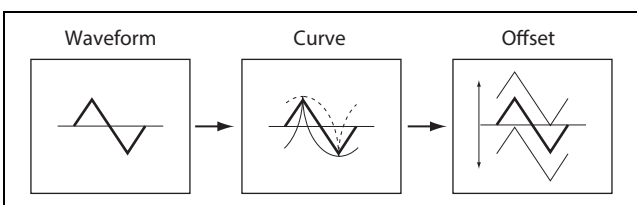

Curve (CURVE)

[−100...+100]

Curve adds curvature to the basic waveform. As you can see in the graphic below, this can make the waveforms either more rounded or more extreme. It can also be useful to emphasize certain value ranges, and deemphasize others.

For example, let's say that you are using a triangle LFO to modulate filter cutoff. If **Curve** emphasizes the high value range, the filter will spend more time at the higher frequencies. If it emphasizes the low range, the filter will spend more time at the lower frequencies.

LFOs

LFO Curve

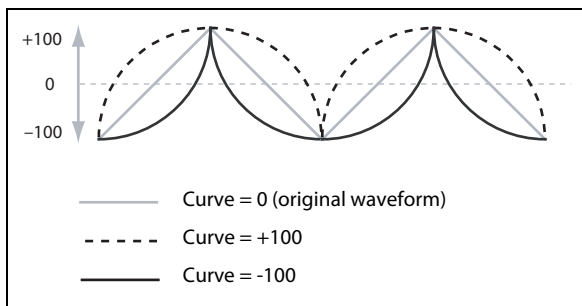

Note: *Curve* does **not** affect the *Square* and *Random 3* waveforms, since their values are always either +100 or -100.

Fade

[0.0000...5.0000 sec]

The LFO can fade in gradually, instead of starting immediately at full strength. This sets the time from note-on until the LFO reaches maximum amplitude.

SYNC NOTES

[Off, On]

This is controlled by the **SYNC NOTES** button.

Off: The LFO starts each time you press a key, and an independent LFO runs for each note. This is the default.

On: The LFO starts from the phase determined by the first note in the phrase, so that the LFOs for all notes being held are synchronized together. **Fade** applies only to the first note in the phrase.

Note: Even if **Sync Notes** is *On*, each note's LFO speed may still be different if modulated by note number, velocity, key scaling, or other note-specific modulation sources.

Modulation Processors

Overview

Modulation Processors transform a modulation signal to make it into something new. The original modulation signal also remains available. There are two Modulation Processors per Program.

The Modulation Processor outputs appear in the list of modulation sources, just like the LFOs and Envelopes.

Type

[Gate, Offset, Quantize, Scale, Curve, Smooth, Sum]

This controls the type of processing performed by the Mod Processor. Each is described in detail below.

Gate

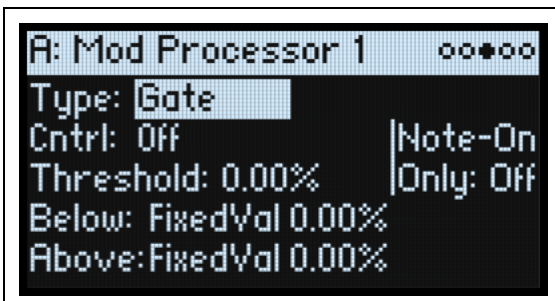

This lets you switch between two modulation sources (or fixed values) using a third modulation source. It's similar to an audio gate with a side-chain, but with even more flexibility—since you get to choose what happens when the gate is closed (below the threshold), as well as when it's open (above the threshold).

For instance, you can use Gate to:

- Apply pitch-bend or other effects to some notes, but not to others (using **Control at Note-On Only**)
- Apply modulation only after the source reaches a certain threshold—for instance, use Velocity to modulate an LFO's frequency, but only once Velocity is greater than 90
- Use a controller to switch between two different LFOs (or any two modulation sources)

Cntrl (Control Source)

[List of Modulation Sources]

This selects the modulation source to control the Gate.

Threshold

[-100.00%...+100.00%]

This sets the value of the Control Source at which the gate opens or closes.

Control at Note-On Only

[Off, On]

When this is *On*, the value of the Control Source is only evaluated at note-on. The selected output will then remain active throughout the duration of the note, regardless of any subsequent change in the Control Source's value. Note that the output value itself can continue to change; only the selection of Below or Above is fixed.

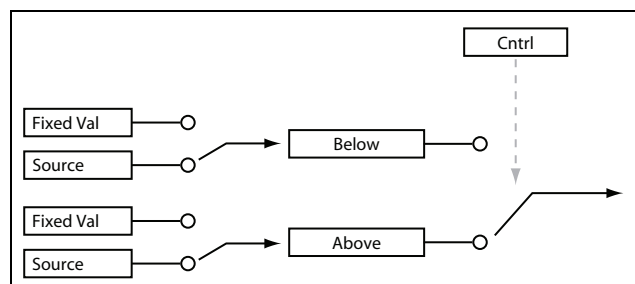

Below (Below Threshold)

[Fixed Val, Source]

This sets the output of the Gate when the Control Source is less than the **Threshold**. When this is set to *Fixed Val*, you can set a value between *-100%* and *+100%*. When it is set to *Source*, you can select any modulation source.

Above (At & Above Threshold)

[Fixed Val, Source]

This sets the output of the Gate when the Control Source is equal to or greater than the **Threshold**.

Offset

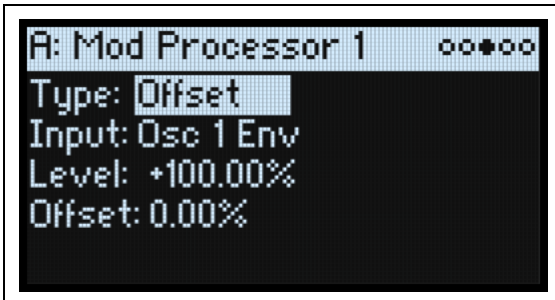

This adds a constant positive or negative offset to a modulation source, and also allows you to double the gain.

Input

[List of Modulation Sources]

This selects the input for the Mod Processor.

Level

[-200.00%...+200.00%]

+200% doubles the original signal level, while -200% doubles the level and inverts the phase.

Offset

[-200.00%...+200.00%]

This controls how the **Input** is shifted up or down.

+200% shifts an input of -100 all the way to +100.

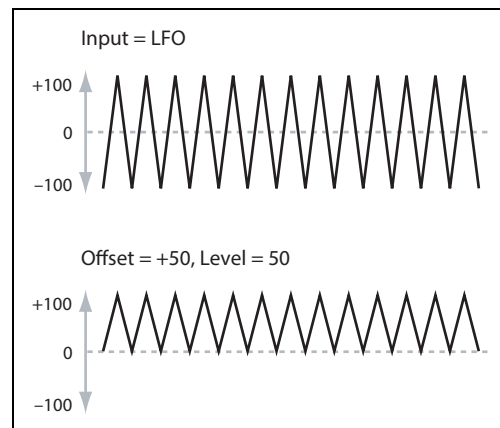

Converting from bipolar to unipolar

You can use *Offset* to convert a bipolar modulation source (both negative and positive), such as an LFO, to a unipolar signal (positive only). To do so:

1. **Select the LFO as the source.**
2. **Set the Input Amount to 50%.**

This cuts the overall level of the LFO in half.

3. **Set the Offset to 50%.**

This shifts the LFO signal up, so that it now swings between 0 and +100.

Converting from unipolar to bipolar

Similarly, you can convert a unipolar modulation source to a bipolar signal:

1. **Select the modulation source as desired.**
2. **Set the Input Amount to +200%.**

This doubles the overall level of the modulation source.

3. **Set the Offset to -100%.**

This shifts the Modulation signal down, so that it ranges from -100 to +100.

Quantize

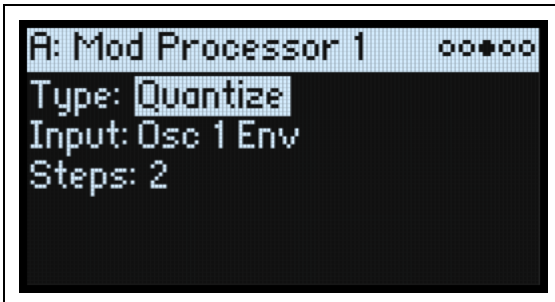

This changes a continuous signal into a series of discrete steps. Use this to change the shape of LFOs or envelopes, or to force a controller to land on a few specific values.

Input

[List of Modulation Sources]

This selects the input for the Mod Processor.

Steps

[1...32]

This controls the severity of the effect. Lower values create more “steppy” effects.

For instance, when this is set to 2, there will be “steps” at 0, 50, and 100. With a bipolar source, there will also be steps at -50 and -100.

Quantized Pitch Bend

You can use Quantize to create quantized pitch bend, for fret-dragging effects, brass rips, and more.

1. Open the Add New Modulation popup (**MOD + >**), and set the Destination to *Pitch Tune*.
2. Press **ENTER** to close Add New Modulation and bring up the Modulation Source popup (since there isn't a front-panel control to select for Mod Processors).
3. Press the OSC 2 LFO button to jump to the middle of the Generators section, and then scroll down to select Mod Processor 1. Press **ENTER** to confirm.
4. Set the Intensity to any exact half-step value: +5.00, +7.00, etc.
5. Set Mod Processor 1's Type to *Quantize*, and set the Input to *Pitch Bend*.
6. Set Steps to the same number you used for Intensity, above.
7. On the Pitch Mod page, set both Pitch Bend Up and Pitch Bend Down to 0 (so that only the Mod Processor version will affect Pitch).

Now, moving the Pitch Bend wheel will create quantized pitch bends.

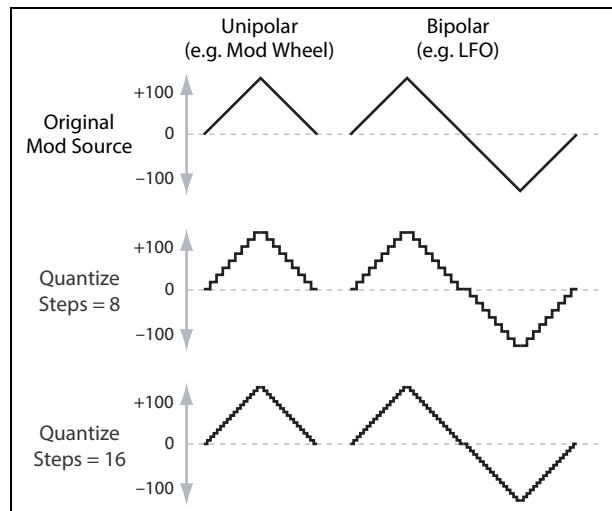

Scale



This processor uses a modulation source to scale the input. For instance, you can control the amount of an LFO with an Envelope, or control the amount of an Envelope with a MIDI controller.

Input

[List of Modulation Sources]

This selects the main input for the Mod Processor.

Main Input Amount

[-100.00%...+100.00%]

This controls the gain and polarity of the input signal, before being scaled by the **Scale Source**. Input from the **Scale Source** then adds to this initial amount.

Even if the **Main Input Amount** is set to 0, the **Scale Source** can still control the final amount of the Main Input over the full +/-100 range.

Scale Source

[List of Modulation Sources]

This selects the modulation source to scale the **Input**.

Scale Amount

[-100.00%...+100.00%]

This controls the gain and polarity of the affect of the **Scale Source**. For example, the main input is an LFO and the **Scale Source** is an Envelope, positive settings mean that the Envelope will increase the amount the of LFO.

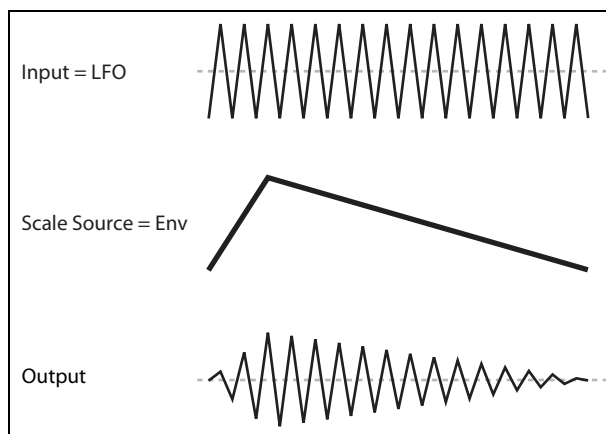

Curve

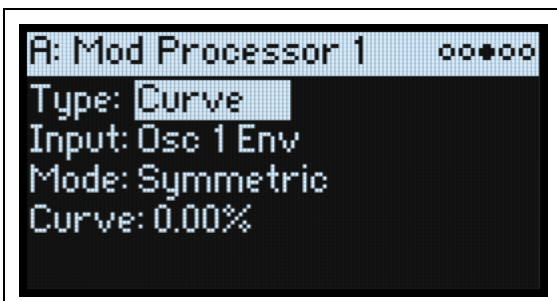

Curve can create custom controller curves, such as exponential wheels, logarithmic velocity, and so on. It can also alter the shape of programmable modulation sources, such as Envelopes and LFOs.

Note: Curve primarily affects modulation signals which already have some amount of slope, such as envelopes, triangle and sine LFOs, and so on. If the signal has only abrupt transitions from one value to another, like a classic sample-and-hold waveform, Curve will affect the values, but not the transitions between them. Curve does not affect signals which contain only maximum, 0, or minimum values, such as square waves.

Modulation Processors

Input

[List of Modulation Sources]

This selects the input for the Mod Processor.

Mode

[Symmetric, Asymmetric]

Asymmetric produces a single curve, extending from -100 to +100.

Symmetric produces two matching curves extending outwards from 0 to -100 and +100, respectively.

Curve and Mode

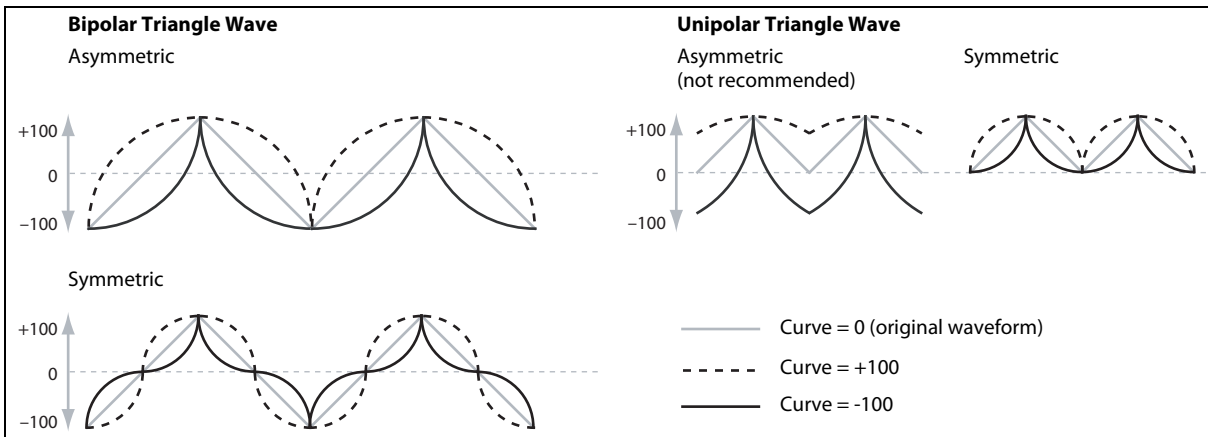

Curve

[-100.00%...+100.00%]

This controls the amount of curvature, and whether the curves are concave or convex.

As you can see in the graphic examples, the curve will emphasize certain value ranges, and deemphasize others. For example, let's say that you are using a triangle LFO, through Curve, to modulate filter cutoff. If Curve emphasizes high values, the filter will spend more time at higher frequencies. If it emphasizes low values, the filter will spend more time at lower frequencies.

Mode	Input	Curve	Result
Symmetric	Unipolar	Positive (+)	emphasizes upper value range
		Negative (-)	emphasizes lower value range
	Bipolar	Positive (+)	emphasizes both upper and lower value ranges, and deemphasizes the center
		Negative (-)	emphasizes center value range, around 0
Asymmetric	Unipolar	Positive (+)	emphasizes extreme upper range, with offset
		Negative (-)	emphasizes extreme lower range, with offset
	Bipolar	Positive (+)	emphasizes upper value range
		Negative (-)	emphasizes lower value range

Bipolar and Unipolar modulation sources

To understand Curve, it helps to understand the difference between *bipolar* and *unipolar* modulation sources.

Bipolar sources can swing all the way from -100 to +100, with 0 in the middle. Most LFOs are bipolar, for instance; so is Pitch Bend. Generally, bipolar modulation sources will work better with the *Asymmetric* mode, but *Symmetric* may also produce interesting results.

Unipolar sources only go from 0 to 100, with 50 in the middle. Often, MIDI controllers are unipolar (though you can also select bipolar versions). Envelopes are usually programmed to be unipolar, even though the Filter and Osc 1/2 Envelopes allow negative levels.

With unipolar sources, it's almost always better to use the *Symmetric* mode; *Asymmetric* can cause offsets and other strange results.

Smooth

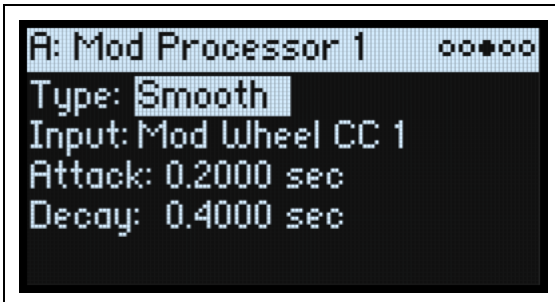

This creates more gentle transitions between values, smoothing out abrupt changes such as a quick move on a wheel or a sharp edge on an LFO.

You have separate control of the amount of smoothing during the attack (when the signal is increasing) and decay (when it's decreasing).

Low settings provide subtle controller smoothing, creating more gradual aftertouch, for instance. Higher settings create auto-fade effects, transforming a quick gesture into a longer fade-in and/or fade-out event.

Smoothing can also be used to alter the shape of programmable mod sources, such as LFOs and envelopes. For instance, you can turn a "blip" into a simple envelope shape, as shown below.

Input

[List of Modulation Sources]

This selects the input for the Mod Processor.

Attack

[0.0000...10.0000 sec]

This controls how long it takes the smoother to reach a new, *higher* value. Higher settings mean longer times.

Decay

[0.0000...10.0000 sec]

This controls how long it takes the smoother to reach a new, *lower* value. Higher settings mean longer times.

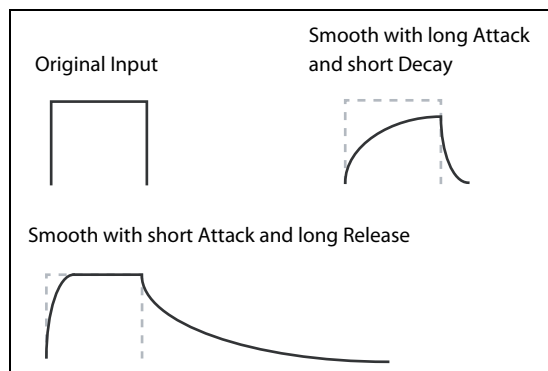

Sum

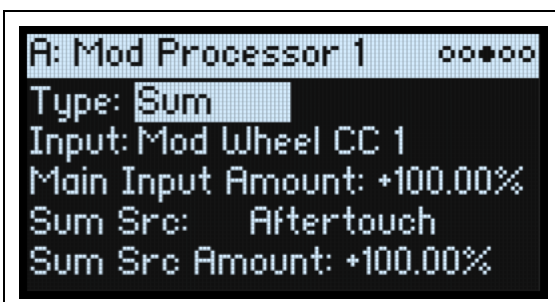

Sum adds two modulation sources together. This is useful if you want to process the combination of two or more signals: for instance, to merge an LFO and an envelope, and then smooth the result.

Modulation Processors

Input

[List of Modulation Sources]

This selects the main input for the Mod Processor.

Main Input Amount

[-100.00%...+100.00%]

This controls the gain and polarity of the **Input**.

Sum Source

[List of Modulation Sources]

This selects the modulation source to merge into the **Input**.

Sum Source Amount

[-100.00%...+100.00%]

This controls the gain and polarity of the **Sum Source**.

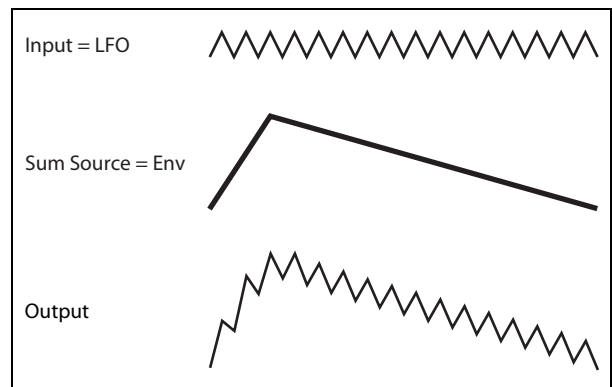

Effects

Overview

Each Layer has its own **PRE FX**, **MOD FX**, and **DELAY**. Additionally, the Performance has a master **REVERB** and parametric EQ. See “Structure” on page 3.

SHIFT-press or double-press the effects buttons to turn them on and off.

Main page

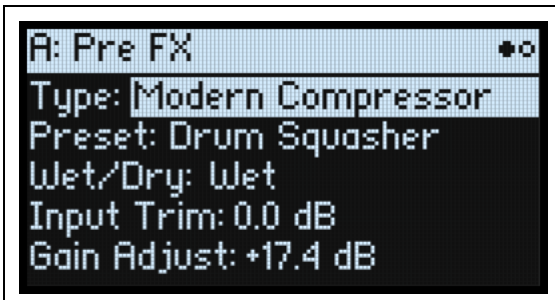

Type (EFFECT TYPE)

[List of Effects]

For each effect, you can select a **Type** (or “algorithm”) and a **Preset** within that **Type**. For full lists of Effect Types, see “Pre FX,” “Mod FX,” “Delay,” and “Master Reverb,” below.

“All” types (*Delay All*, *Chorus All*, etc.) let you select **Presets** from all related algorithms.

Preset

[List of Presets]

These are the presets available for the selected **Type**.

Wet/Dry (WET/DRY)

[Dry, 1:99...99:1, Wet]

This appears for the Pre FX, Mod FX, and Delay. It controls the balance between the original signal (*Dry*) and the effected signal (*Wet*).

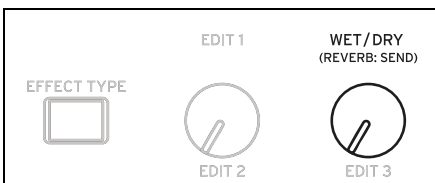

Layer A Send (REVERB: SEND)

[-Inf, -84.9...+6.0 dB]

This appears for the Master Reverb only. It controls the amount of signal sent from Layer A to the Master Reverb.

Layer B Send (REVERB: SEND)

[-Inf, -84.9...+6.0 dB]

This controls the amount of signal sent from Layer B to the Master Reverb.

Level controls

Additional level-related parameters may be available on-screen, depending on the effect **Type**.

Input Trim

[-Inf, -84.9...0.0 dB]

This controls the volume level into the effect. Use this to alter the response of effects such as the *Waveshaper*, or to compensate for gain increases in effects such as the *Talking Modulator*.

Volume

[-Inf, -84.9...+12.0 dB]

This control the post-**Drive** output of the **Guitar Amp**. Use it to compensate for level changes caused by **Drive**.

Output Level

[-Inf, -84.9...0.0 dB]

This controls the output volume from the effect. Use it to compensate for level changes in effects such as the *Waveshaper*.

Gain Adjust

[-Inf, -84.9...+24.0 dB]

This is similar to Output Level, but provides up to 24dB of gain. It appears only for the **Modern Compressor**.

Edit page

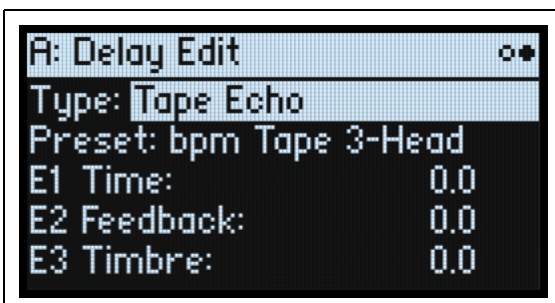

The **EDIT 1/2/3** controls (E1/E2/E3 on the display) are macros which may control multiple internal parameters, and which may be set up differently for each **Preset**. There are general conventions for the **EDIT** knobs of each effect **Type**, as reflected in the on-screen labels.

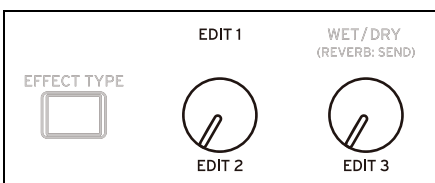

Pre FX

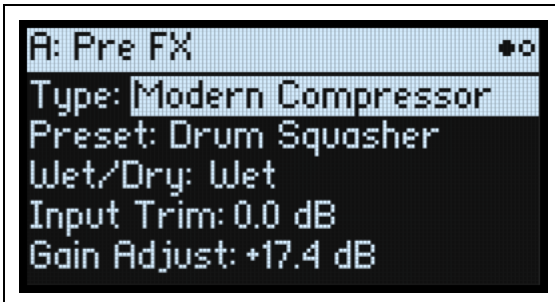

Decimator

This stereo effect models vintage digital gear, lowering the sampling frequency and reducing bit depth.

Graphic EQ

This is a stereo graphic EQ with macro controls.

Guitar Amp

This mono effect models a selection of guitar amps and speaker cabinets, for everything from subtle saturation to roaring distortion.

Modern Compressor

This is a stereo compressor with a modern sound.

Parametric EQ

This is a stereo EQ with a single adjustable parametric band. Presets may include additional EQ.

Red Compressor

Need to play chordal passages with smooth, even dynamics? Then, look no further: this mono compressor is modeled on a pedal whose clean sound made it hugely popular.

Ring Modulator

This stereo effect creates a metallic sound by modulating the input via an LFO-controlled oscillator.

Tremolo

This stereo effect modulates volume with an LFO, optionally controlled by an envelope follower.

Wave Shaper

This stereo effect is very sensitive to input level. Different table selections generate various types of overtones and distortion.

Mod FX

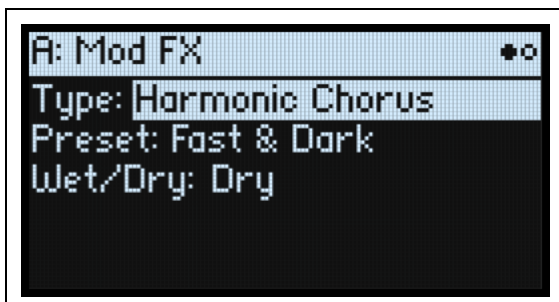

Black Chorus/Flanger

This is modeled after a classic mono-in, stereo-out chorus known for both crystal-clean tone and quiet operation, and especially well-suited to tine electric pianos.

Black Phase

This mono phaser is inspired by a classic European pedal effect.

CX-3 Vibrato Chorus

This effect models the scanning chorus and vibrato circuitry of a vintage organ.

EP Chorus

This is inspired by a rare chorus built into a famous modified tine piano.

Harmonic Chorus

This stereo effect applies chorus only to higher frequencies—particularly useful for bass sounds. Some presets use feedback to turn the chorus into a flanger.

Modern Chorus

This stereo effect adds thickness and warmth to the sound by modulating the delay time of the input signal.

Modern Phaser

This is a modern, stereo phaser effect.

Orange Phase

This models a mono phaser pedal which is a favorite on many recordings. It's useful for adding sparkle, animating chord passages, and widening and fattening the sound.

Polysix Ensemble

This models the mono-in, stereo-out ensemble effect built into the classic Korg Polysix synthesizer.

Small Phase

This models a classic mono phaser made in New York City during the 70s, with its warm, rich tone and liquid transparency.

Talking Modulator

This mono effect applies vowel formant filters, like a human voice, to the input.

Vintage Chorus

This models a mono chorus best-known for being built into a guitar amp. **Speed** and **Depth** provide a broader range of sounds than the original device.

Vintage Flanger

A model of a truly classic mono analogue flanger. This amazing stompbox's bucket-brigade technology provides a sweeping, whooshing sound, perfect for chords.

Vintage/Custom Wah

This stereo effect models the tonal character of a vintage wah pedal.

Vox Wah

This effect is modeled on the unique “throaty” tones of two legendary VOX wah pedals: the V847 and the V848 Clyde McCoy model.

Delay



L/C/R Delay

This mono-in, stereo-out multitap delay has three taps panned to the left, right, and center respectively.

Multiband Mod Delay

This monster effect divides the input signal into four frequency bands, with a modulatable delay for each band. It can produce everything from complex, frequency-specific delays to thick choruses.

Reverse Delay

This effect includes a reverse delay followed by additional left and right delays. Presets provide various feedback options.

Stereo/Cross Delay

This true-stereo delay provides up to 2,730 msec of delay time.

Tape Echo

This effect models a tape echo with up to three playback heads, including tape saturation.

Master Reverb

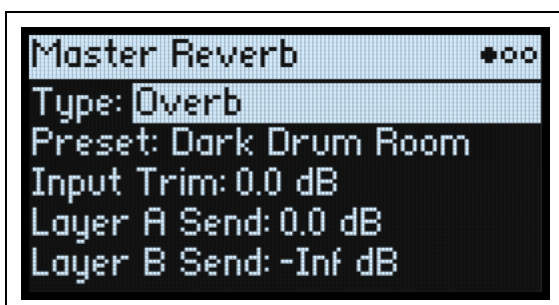

Early Reflections

This provides different early reflection patterns, useful for small ambiences, gated reverbs, and reverse effects.

Overb

The Overb features a high-quality, diffusion-based reverb core, including randomization for richer and smoother reverb timbres.

Master EQ

Performances include a dedicated four-band parametric EQ. To edit the EQ:

1. Press **REVERB**.
2. Use **PAGE+/-** to go to the Master EQ page.

The Master EQ page will appear.

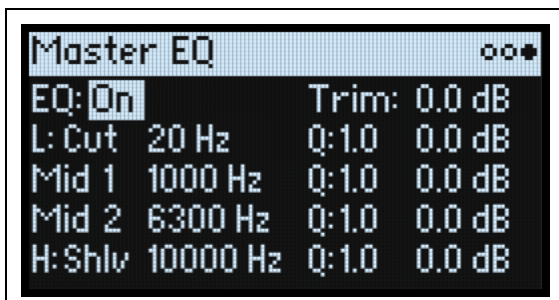

EQ

[Off, On]

This enables and disables the Master EQ.

Trim

[-Inf, -84.9...0.0 dB]

Use this volume control to compensate for EQ boosts.

L (Low) and H (High)

(Mode)

[Pk, Shlv, Cut]

The Low and High bands can be set to *Pk* (Peaking), *Shlv* (Shelving), or *Cut* (Low cut/High cut).

(Frequency)

[20...20,000 Hz]

If **Mode** is set to *Pk* (Peaking), this sets the band's center frequency; if **Mode** is set to *Shlv* or *Cut*, it sets the cutoff frequency.

Q

[0.5...10.0]

This controls the width of the band when **Mode** is set to *Pk* (Peaking).

(Gain)

[-18.0...+18.0 dB]

This sets the amount of cut or boost for the band.

Mid 1 and Mid 2

These bands are always in Peaking mode. Otherwise, their controls are similar to Low and High, as described above.

Randomize

Randomize uses a combination of preset selection and select value randomization, rather than direct randomization of all parameters.

Using Randomize

To randomize the entire Performance:

1. Press the  (Randomize) button.

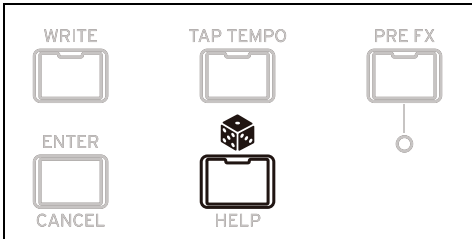

The Randomize page will appear, with **Scope** set to *Performance* by default. If **Scope** has been previously changed to another setting, hold  and press **PERFORM**.

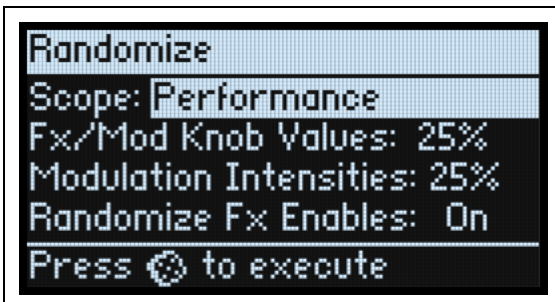

Depending on the Scope, additional settings may appear:



Fx/Mod Knob Values randomizes the Mod Knobs (Program and/or Performance, according to **Scope**) and Effects Edit 1/2/3 by the specified percentage.

Modulation Intensities randomizes the standard LFO and Envelope intensities for Filter, Amp, Osc 1/2, and Pitch.

Randomize Fx Enables controls the On/Off settings for the Effects (with probability weighted towards On).

2. Press  again to randomize everything in all layers, and then **ENTER** to confirm.

To randomize a specific section of the synth:

1. Press and hold .
2. While holding , press the button for the desired section (**PERFORM**, **WAVE SELECT**, **SEQ STEPS**, **ARPEGGIATOR**, **FILTER TYPE**, **AMP**, **PITCH**, **LAYER A/B**, or any Effect); press a Motion Sequence Lane button (pressing **SHIFT** is not required for Lane selection here); or move a Filter or MOD knob.

The Randomize page will appear, with the selected **Scope**. You can still change the **Scope** again, if desired. Additional **Scope** options are available from the on-screen menu.

3. Press  to execute the randomization, and then **ENTER** to confirm.

Utility

System Setup

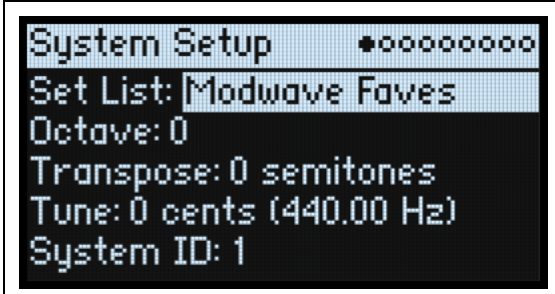

Set List

[List of Set Lists]

This selects the current Set List, which maps Performances to the SET LIST buttons. You can store many Set Lists, and change between them as you like.

Octave (OCTAVE +/-)

[-4...+4]

This shifts the keyboard up or down by up to four octaves. It's generally controlled by the front panel **OCTAVE** buttons, although these can optionally control scale selection, instead; see "Octave Selects Scale" on page 95. When controlling Octave, the **OCTAVE** buttons change color according to the degree of transposition:

Octave	Color
-1/+1	Green
-2/+2	Yellow
-3/+3	Orange
-4/+4	Red

Transpose

[-12...+12 semitones]

This adjusts the pitch in semitone steps over a ± 1 octave range.

Note: Transpose is affected by the **Convert Position** setting; see "Convert Position" on page 92.

Tune

[-50 (427.47Hz)...+50 (452.89Hz)]

This adjusts the overall tuning of the entire modwave in one-cent units, over a range of ± 50 cents. (A cent is 1/100 of a semitone.) At the default of 0, A4 = 440 Hz.

 The value shown for A4's frequency assumes that the scale is set to Equal Temperament. If a different scale is selected, the actual frequency of A4 may be different.

System ID

This number identifies the modwave to computer hosts. If you have multiple modwaves, set each to a different number.

MIDI & USB



Global Channel

[1...16]

This is the basic MIDI channel for the modwave. It applies to:

- MIDI sent from the built-in keyboard and controllers (except for Program Mod Knobs)
- MIDI received by any Layer with **Use Global MIDI Channel** enabled
- MIDI CCs received by and sent from the Program Mod Knobs, for any Layer with **Use Global MIDI Channel** enabled
- Program Change (via Set Lists)
- Other global functionality, such as modulation of Master Reverb, System Exclusive, and Arpeggiator

Local Control

[Off, On]

On: This is the default; the modwave's internal sounds will be played by the built-in keyboard and controllers. If you are playing the modwave by itself, leave this setting checked.

Off: The modwave's keyboard and controllers, including the Mod Knobs, will be disconnected from the internal sounds. MIDI transmit and receive will continue to work normally. Use this setting if loop-back from an external sequencer causes duplicate notes.

Clock

[Internal, External, Auto]

Internal: The modwave will use the Performance's Tempo setting (also shown and controlled by the **TAP TEMPO** button). Use this when playing the modwave by itself, or when you want the modwave to control the tempo of external MIDI devices such as a sequencer or drum machine.

External: The modwave tempo will synchronize to incoming MIDI Clock messages from either 5-pin MIDI or USB. If MIDI clocks are not being received, tempo-related features will not function.

Auto: This combines the functionality of *Internal* and *External*, so that you don't have to manually switch between the two:

- If MIDI Clocks are not being received, the modwave uses its internal tempo.
- If MIDI Clocks are being received, they control the tempo. If the clocks stop for more than 500 ms, the modwave switches back to internal tempo.

USB Network

[RNDIS, NCM]

The modwave uses USB networking to communicate with the Editor Librarian and Updater software on MacOS and Windows computers. This selects the network protocol which will be used. Some computer operating systems may require one setting or the other; for the latest information, please see the documentation included with the Editor Librarian or Updater.

 Changes to this parameter take effect only after the modwave has been turned off and restarted.

RNDIS: This is the RNDIS protocol.

NCM: This is the Network Control Model protocol. NCM is supported natively in recent versions of MacOS.

Controllers

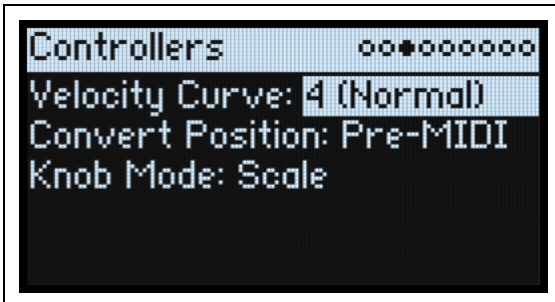

Velocity Curve

[1 (Heavy), 2, 3, 4 (Normal), 5, 6, 7, 8 (Light), 9 (Wide)]

This controls how the volume and/or tone responds to variations in keyboard playing dynamics (velocity). Choose the curve that is most appropriate for your playing strength and style.

Velocity Curves always work the same way between the built-in keyboard and the synth engine. The way that they relate to MIDI, however, is tied to the **Convert Position** setting (see below).

Velocity curves

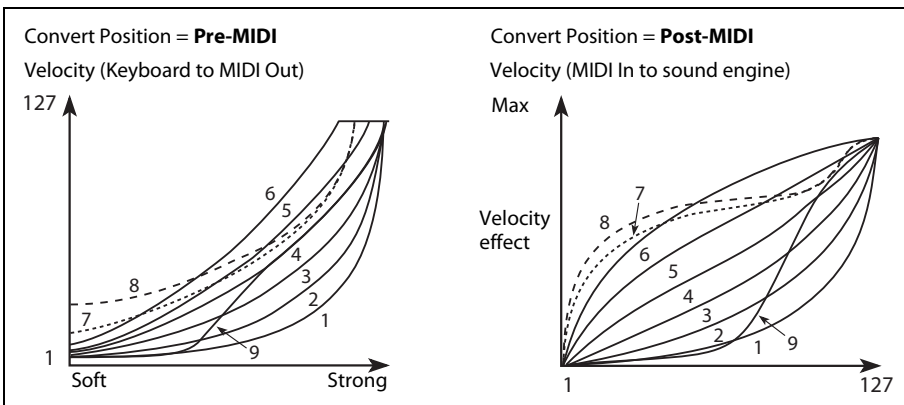

1 (Heavy), 2, 3: These are for heavy playing; most of the variation occurs in the upper velocity range.

4 (Normal): This is the default.

5, 6: These are for lighter playing.

7: This is for very light playing, at the expense of control in the middle of the range.

8 (Light): This curve produces the most uniform output, for when velocity sensitivity is not desired.

9 (Wide): This curve is designed for the heavier touch of external weighted keyboards.

Convert Position

[Pre-MIDI, Post-MIDI]

This setting controls how the **Transpose** and **Velocity Curve** settings work. You can think of these as a set of MIDI effects processors, which can be used in one of two places within the modwave.

Note: Regardless of the **Convert Position**, **Transpose** and **Velocity Curve** always apply when playing internal sounds directly from the modwave keyboard.

Pre-MIDI: This is the default. **Transpose** and **Velocity Curve** affect MIDI **output**.

Utility

Convert Position = Pre-MIDI

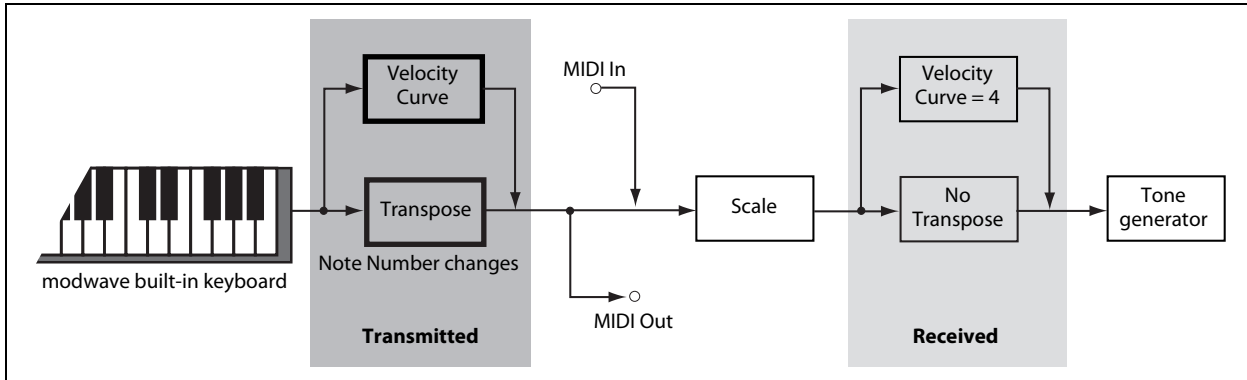

Post-MIDI: **Transpose** and **Velocity Curve** affect MIDI *input*. Use this to adjust response to an external MIDI controller.

Post-MIDI also shifts Global and Performance Scales to match the **Transpose** setting—convenient for use with non-equal-tempered scales. See also “Layer Transpose” on page 95.

Convert Position = Post-MIDI

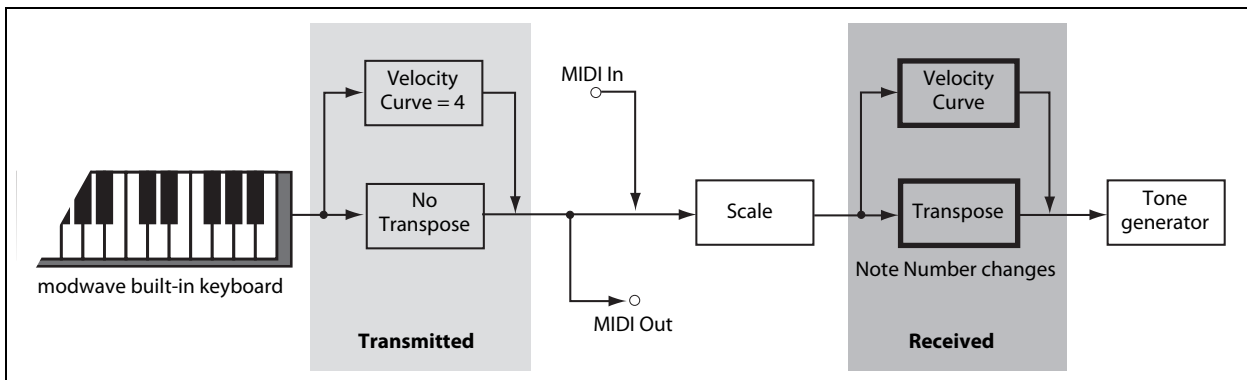

Knob Mode

[Scale, Jump]

When you switch to a new Performance or select a different Layer, Motion Sequence Lane, Effect, Envelope, LFO, etc., the parameter values “underneath” the front-panel knobs will change—but the physical knobs won’t move automatically. **Knob Mode** controls what happens when you move a knob.

Scale: This is the default. The physical position of the knob is mapped to the current parameter value. Moving the knob counter-clockwise goes from the current value to the minimum; moving clockwise goes from the current value to the maximum. If you turn the knob all the way to the left or right, the range is reset. See the graphic below.

Jump: When a knob is moved, the parameter value instantly changes to match the position of the knob.

Knob Mode set to Scale

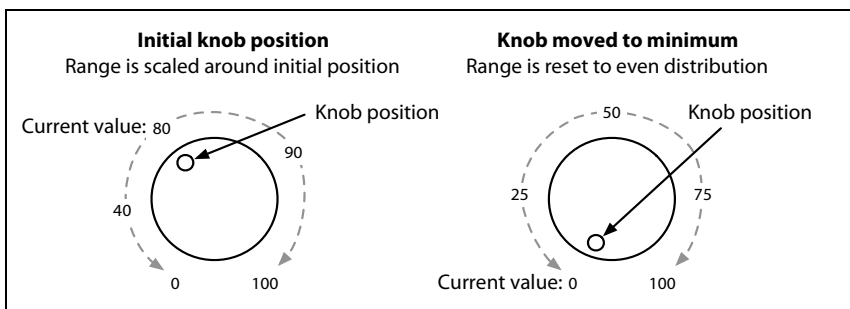

MIDI CC Assign

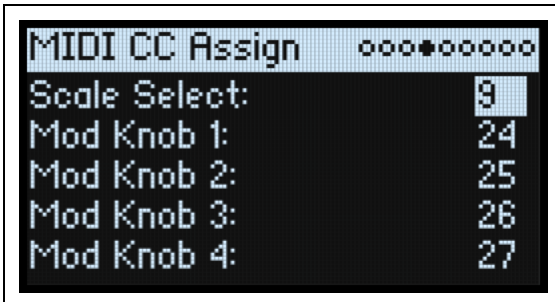

You can control Scale Select and each Mod Knob directly from MIDI CCs. These CCs edit the assigned parameters, just like moving the front-panel knobs. To modulate a parameter with variable intensity, and without causing edits to the sound, use modulation instead. Some dedicated CCs cannot be assigned (CCs 1, 7, etc.).

Function	Default CC assignment
Scale Select	9
Mod Knobs 1...4	24...27

Global Scale

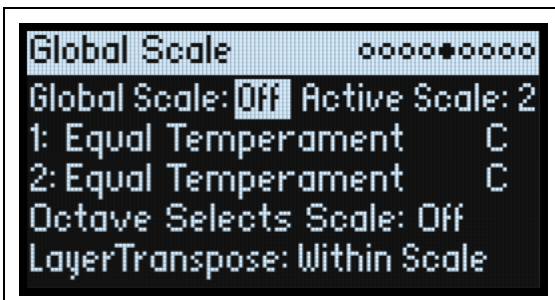

Global Scale

[Off, On]

On: The settings on this page control the instrument's scales. Performance scales are ignored.

Off: The scale settings on this page are ignored.

Note: If both **Global Scale** and **Performance Scale** are *Off*, the system simply uses equal temperament.

Active Scale

[1, 2]

If **Global Scale** is *On*, this chooses which of the two scales below is used. You can control this via MIDI. See also "Octave Selects Scale," below.

1 (Scale 1)

[*Arabic, Equal Temperament, Kirnberger, Pelog, Pure Major, Pure Minor, Pythagoras, Slendro, Stretch, Werkmeister*]

This selects the first scale to be used.

Arabic: This includes the quarter-tone intervals used in Arabic music.

Pythagoras: Especially effective for melodies, this produces 11 completely pure fifths, at the expense of other intervals—thirds in particular. To maintain the tuning of the octave, the final fifth—from sharp four to sharp root—is also quite flat.

Werkmeister (Werkmeister III), Kirnberger (Kirnberger III): These are "Well-Tempered" tunings from the Baroque period.

Utility

Pelog: This Indonesian gamelan scale uses seven notes per octave. When **Key** is set to C, use the white keys. The black keys will play the equal tempered pitches.

Pure Major, Pure Minor: These are Just Intonations optimized for major and minor keys, respectively. Unlike the other scales, they maintain the A4 tuning (e.g. A=440 Hz) as set by the Global **Tune** parameter (see “Tune” on page 90). Because of this, the root note of the selected **Key** may shift from its equal-tempered pitch.

Slendro: This Indonesian gamelan scale has five notes per octave. When **Key** is set to C, use C, D, F, G and A. Other notes will play the normal equal-tempered pitches.

Stretch: In this acoustic piano tuning, notes below the middle of the keyboard are progressively more flat, and notes above the middle are progressively more sharp.

(Key)

[C...B]

This controls the root key of the scale. Key applies only to repeating 12-note scales.

Note: Specific combinations of **Scale** and **Key** may skew the reference tuning pitch. For example, A4 might become 442 Hz, instead of 440 Hz. Use **Master Tune** to correct this, if necessary.

2 (Scale 2)

(Key)

These are the second **Scale** and its associated **Key**.

Octave Selects Scale

[Off, On]

If this is *On*, the **OCTAVE** down button selects Scale 1, and **OCTAVE** up selects Scale 2 (for either the Global or Performance scale, depending on which is in use). **SHIFT+OCTAVE** then performs octave up/down functionality.

Layer Transpose

[Transposes Scale, Within Scale]

This parameter determines how the Layer **Transpose** parameters interact with the Scale and Key.

Within Scale means that transposition uses intervals within the current scale. This option works well if you are using non-equal-tempered scales and want to build parallel intervals (such as “fat fifths”) into your sounds. For example, let’s say that you are using Just Intonation in the key of C. If you transpose one of the Timbres up by 7 semitones and play a C, the result will be two notes: C, and G 2 cents sharp (the Just Intonation fifth).

Transposes Scale means that the Scale’s Key changes to match the transposition. This option is useful if you play in non-equal-tempered scales and transpose entire songs—to accommodate singers, for example. In other words, let’s say that the **Key** is set to C, and the third note of the scale (E) is 50 cents flat. If you transpose up by 2 semitones, and play an E, the result will be an F# 50 cents flat—still the third note of the scale. For this application, it’s also best to set the **Convert Position** to *Post-MIDI*; for more information, see “Convert Position” on page 92.

Preferences

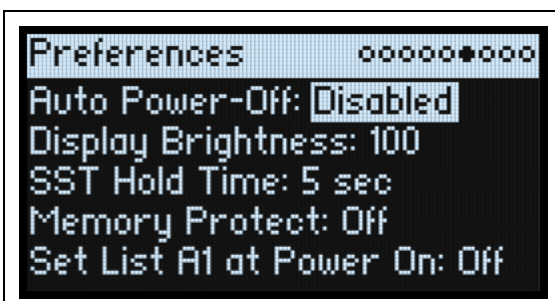

Auto Power-Off

[Disabled, 4 Hours]

By default, to conserve energy, the modwave will automatically turn off after about four hours have elapsed without use of the front panel, keyboard, or MIDI input. You can disable this feature, if desired.

Utility

 When the power turns off, any un-saved edits or settings will be lost. Make sure that you save important settings before this occurs.

Display Brightness

[0...100]

This controls the brightness of the OLED display.

SST Hold Time

[0 ms...60 sec]

This controls the duration of Smooth Sound Transitions. It sets how long reverbs, delays, and note releases continue to ring out after a new sound has been selected. The timer starts after all notes from the previous sound are no longer being held down, and the sustain pedal is released.

Memory Protect

[Off, On]

When this is *On*, Write functionality is disabled.

Set List A1 at Power On

[Off, On]

Off: At power-up, the last-used sound will be selected.

On: At power-up, Set List Slot A1 will be selected.

System Stats

This page provides diagnostic information for the system.

CPU Usage

[0.00...100.00%]

This shows the percentage of available processing power being used for voices and effects.

Temperature

[°C]

This shows the CPU's temperature.

Sounding Voices

[0...32]

This shows the number of voices currently being played.

Voice Stealing

[0...32]

Sometimes, if a lot of voices are already sounding, there won't be enough free power to play a new voice. When this happens, the system stops older or lower-priority voices so that the CPU can be used for the new voice instead. This is called "voice stealing." This shows the amount of voice stealing, in real time.

About

This page shows the software version number and abbreviated credits. The modwave is the result of a team effort, built through the talents of many more people than can be listed on-screen!

USB

You can connect the modwave to computers via USB, to send and receive MIDI and to edit and organize sound data with the modwave Editor Librarian.

MIDI

The modwave is a class-compliant USB MIDI device, and requires no driver for MIDI functionality.

Editor Librarian

The modwave Editor Librarian supports MacOS and Windows, and is available as a download from www.korg.com. For more information, please see the documentation included with the download.

Specifications

System

Keyboard: 37 keys (velocity and release-velocity sensitive)

Maximum Polyphony: 32 stereo voices

Sound generating system: modwave synthesis engine

Modulation

Controllers: Mod Wheel, Pitch Wheel, Kaoss Physics, 4x Mod Knobs

Other Sources: 4x Envelopes, 5x LFOs, 2x Mod Processors, 2x Key Track, Seq Lanes A-D, Step Pulse, Tempo, Program/Performance Note Count, Program/Performance Voice Count, Poly Legato, Velocity, Exponential Velocity, Release Velocity, Gate, Gate+Damper, Note-On Trigger, Note-On Trigger+Damper, Note Number, Aftertouch and Poly Aftertouch (external MIDI only), MIDI CCs +/-, MIDI CCs +

Destinations: Most parameters can be modulated, including parameters of individual Motion Sequence Steps. Depending on Motion Sequence length, there can be more than 1,000 potential modulation targets per Program.

Effects

Pre FX: Decimator, Graphic EQ, Guitar Amp, Modern Compressor, Parametric EQ, Red Compressor, Ring Modulator, Tremolo, Wave Shaper

Mod FX: Black Chorus/Flanger, Black Phase, CX-3 Vibrato Chorus, EP Chorus, Harmonic Chorus, Modern Chorus, Modern Phaser, Orange Phase, Polysix Ensemble, Small Phase, Talking Modulator, Vintage Chorus, Vintage Flanger, Vintage/Custom Wah, Vox Wah

Delay: L/C/R Delay, Multiband Mod Delay, Reverse Delay, Stereo/Cross Delay, Tape Echo

Master Reverb: Early Reflections, Overb

Master EQ: 4-band parametric EQ

General

Inputs/outputs: Headphone (6.3 mm stereo phone jack), OUTPUT L/MONO and R (impedance-balanced 6.3 mm TRS phone jacks), DAMPER (6.3 mm phone jack, half-damper not supported), MIDI IN and OUT connectors, USB B port

Power supply: AC adapter (DC12V, 2500mA)

Power consumption: 5 W

Dimensions (W × D × H): 565 × 338 × 92 mm/22.24" × 13.31" × 3.62"

Weight: 2.9 kg/6.93 lbs.

Included items: AC adapter, Precautions, Quick Start Guide

Accessories (sold separately): DS-1H damper pedal, PS-1 pedal switch, PS-3 pedal switch

* Specifications and appearance are subject to change without notice for improvement.

* All product names and company names are the trademarks or registered trademarks of their respective owners.

MIDI implementation chart

Function		Transmitted	Recognized	Remarks
Basic Channel	Default	1-16	1-16	Memorized
	Changed	1-16	1-16	
Mode	Default		3	
	Messages	X	X	
	Altered	*****		
Note Number		0-127	0-127	Some sounds will not play across the entire note range
	True Voice	*****	0-127	
Velocity	Note On	O 9n, V=1-127	O 9n, V=1-127	Received Note Off Velocity values are clipped at 64
	Note Off	O 8n, V=1-64	O 8n, V=0-127	
After Touch	Polyphonic (Key)	X	O	
	Channel	X	O	
Pitch Bend		O	O	
Control Change	1	O	O	Modulation
	7	X	O	Volume
	10	X	O	Pan
	11	X	O	Expression
	18, 19	O	O	Kaoss Pad X, Y
	64	O	O	Damper
	66	X	O	Sostenuto
	67	X	O	Soft
2-6, 8-9, 12-31, 32-63, 65, 67-95, 102-119	O	O	Assignable for controllers and modulation *1	
120, 121	X	O	All Sounds Off, Reset All Controllers	
Program Change		O 0-63	O 0-63	Selects Slots in the current Set List
	True Number	*****	0-63	
System Exclusive		O	O	Kaoss Physics *2
System Common	Song Position	X	X	
	Song Select	X	X	
	Tune Request	X	X	
System Real Time	Clock	O	O	
	Commands	X	X	
Aux Messages	Local On/Off	X	X	
	All Notes Off	X	O 123-127	
	Active Sense	O	O	
	System Reset	X	X	

Notes *1: Sent and received by Mod Knobs and Scale Select when assigned in UTILITY > MIDI CC Assign; also received as programmable modulation sources
 *2: Also supports universal system exclusive messages device inquiry, master volume, master fine tuning, and master coarse tuning

Mode 1: Omni On, Poly Mode 2: Omni On, Mono O: Yes
 Mode 3: Omni Off, Poly Mode 4: Omni Off, Mono X: No

Consult your local Korg distributor for more information on the MIDI implementation.

KORG INC.

4015-2 Yanokuchi, Inagi-City, Tokyo 206-0812 JAPAN

© 2021 KORG INC. www.korg.com

Published 06/2021