

Version OS 1.2



# ALPHA BASE

ANALOG DRUM SYNTHESIZER

## Operating Manual

<b>1 INTRODUCTION.....</b>	<b>11</b>
1.1 A BRIEF INTRODUCTION TO THE ALPHA BASE.....	11
1.1.1 Kick Drum .....	11
1.1.2 MBrane .....	11
1.1.3 Samples+Filter.....	11
1.1.4 Hi Hat .....	12
1.1.5 Clap, Rim, Crash, Ride .....	12
1.1.6 X Sample 1+2 .....	12
1.1.7 FM Synth .....	12
1.1.8 Effects .....	13
1.1.9 Editing .....	13
1.1.10 Manual convention.....	13
<b>2 CONNECTION.....</b>	<b>14</b>
2.1.1 Power Supply.....	14
2.1.2 Audio connections.....	14
2.1.3 USB Connection.....	14
2.1.4 MIDI Connections.....	15
2.1.5 MIDI OUT.....	15
2.1.6 MIDI Thru.....	15
2.1.7 Sync Out 1+2.....	15
2.1.8 SD Card Slot.....	16
2.2 QUICK START .....	17
2.2.1 First Steps.....	17
2.2.2 Select Presets:.....	18
2.2.3 Select Patterns:.....	18
2.2.4 Select Instruments (=tracks): .....	19
2.2.5 Mute Instruments:.....	19
2.2.6 Edit Instrument:.....	19
2.2.7 Store Kit Preset:.....	19
2.2.8 Store Pattern:.....	19
2.2.9 Edit Tempo:.....	19
2.2.10 Edit Patterns:.....	20
2.2.11 Set/Clear Accents:.....	20
2.2.12 Select Bar (Measure):.....	20
2.2.13 Pitch Sequence:.....	20
2.2.14 Editing Sample based instruments .....	20
<b>3 THE USER INTERFACE.....</b>	<b>21</b>

3.1	ENCODER MATRIX AND LEDs.....	21
3.1.1	<i>Muting Instruments/Encoder Click</i> .....	21
3.2	ANALOG CONTROLS.....	21
3.2.1	<i>Input Gain</i> .....	21
3.2.2	<i>Phones</i> .....	21
3.2.3	<i>Mix Volume</i> .....	21
3.3	MENU CONTROLS.....	22
3.3.1	<i>DATA</i> .....	22
3.3.2	<i>LEFT/RIGHT</i> .....	22
3.3.3	<i>KIT/SEQ</i> .....	22
3.3.4	<i>DISK</i> .....	22
3.3.5	<i>BPM/MIDI</i> .....	22
3.3.6	<i>BANK 1 - 4</i> .....	23
3.3.7	<i>PAGE A/B</i> .....	23
3.3.8	<i>BAR A, B, C, D</i> .....	23
3.4	SEQUENCER/EDIT CONTROLS.....	23
3.4.1	<i>SEQ</i> .....	24
3.4.2	<i>CHAIN</i> .....	24
3.4.3	<i>X-REC</i> .....	24
3.4.4	<i>EDIT/TRIG</i> .....	24
3.4.5	<i>DOWN/UP</i> .....	24
3.5	STEP SEQUENCER CONTROLS.....	25
3.5.1	<i>Start</i> .....	25
3.5.2	<i>Stop</i> .....	25
3.5.3	<i>Enter</i> .....	25
3.5.4	<i>Shift/Cancel</i> .....	25
3.5.5	<i>Scale Stripes</i> .....	25
3.5.6	<i>Step 1-16 buttons and LEDs</i> .....	25
3.5.7	<i>Instrument Keys</i> .....	25
<b>4</b>	<b>KIT/SEQ.....</b>	<b>26</b>
4.1	SELECT A DRUM KIT:.....	26
4.1.1	<i>Kit Select Mode</i> .....	26
4.1.2	<i>Parameter Mode</i> .....	26
4.2	NAMING OF A KIT.....	27
<b>5</b>	<b>EDITING.....</b>	<b>28</b>
5.1	SELECT AN INSTRUMENT.....	28
5.2	PLAY AN INSTRUMENT.....	28

5.3 EDIT AN INSTRUMENT.....	28
<b>6 ANALOG INSTRUMENTS.....</b>	<b>29</b>
6.1 KICK DRUM.....	29
6.1.1 KD Page 1 A = Page 1 B.....	29
6.1.1.1 Tune < 000-127 >.....	29
6.1.1.2 Pitch < 000-127 >.....	29
6.1.1.3 Decay < 000-127 >.....	29
6.1.1.4 Harm = Harmonics < 000-127 >.....	29
6.1.2 KD Page 2 A.....	30
6.1.2.1 Attack < 000-127 >.....	30
6.1.2.2 Pulse < 000- 127 >.....	30
6.1.2.3 Noise < 000-127 >.....	30
6.1.2.4 EQ < 000- 127 >.....	30
6.1.3 KD Page 2 B.....	31
6.1.3.1 PtAtk = Pitch Attack < 000-127 >.....	31
6.1.3.2 PtDec = Pitch Decay < 000- 127 >.....	31
6.1.4 KD Page 3 A = Page 3 B.....	32
6.1.4.1 Compr = Compression < 000-127 >.....	32
6.1.4.2 MetNz = Metal Noise < off/noi-127 >.....	32
6.1.4.3 EVAmt = Envelope Amount < 000-127 >.....	32
6.1.4.4 Gate < 000-127 >.....	32
6.1.5 KD Page 4 A.....	33
6.1.5.1 LFWav = LFO Wave < 000-063 >.....	33
6.1.5.2 LFRat = LFO Rate < 000-127 >.....	33
6.1.5.3 LFInt = LFO Intensity < 000-127 >.....	33
6.1.5.4 Vol = Volume < 000-127 >.....	33
6.1.6 KD Page 4 B.....	34
6.1.6.1 Acc = Accent < 000-127 >.....	34
6.2 MBRANE.....	35
6.2.1 MB Page 1 A.....	37
6.2.1.1 Pitc1 = M1 Pitch < 000- 127 >.....	37
6.2.1.2 Damp1 = M1 Dampen < 000-127 >.....	37
6.2.1.3 Pitc2 = M2 Pitch < 000-127 >.....	37
6.2.1.4 Damp2 = M2 Dampen < 000-127 >.....	37
6.2.2 MB Page 2 A.....	38
6.2.2.1 Cupl1 = Coupling 1->2 < 000-127 >.....	38
6.2.2.2 Cupl2 = Coupling 2->1 < 000-127 >.....	38
6.2.2.3 Noise < 000-127 >.....	38
6.2.2.4 Decay < 000-127 >.....	39
6.2.3 MB Page 2 B.....	39
6.2.3.1 P1Atk = Pitch1 Attack < 000-127 >.....	39

## Version OS 1.2

6.2.3.2	P1Dec = Pitch1 Decay < 000-127 >.....	39
6.2.3.3	P2Atk = Pitch2 Attack < 000-127 >.....	39
6.2.3.4	P2Dc = Pitch2 Decay < 000-127 >.....	39
6.2.4	<i>MB Page 3 A</i> .....	40
6.2.4.1	NzFil = Noise Filter < 000-127 >.....	40
6.2.4.2	MtNz1 = Metal Noise 1 < 000-127 >.....	40
6.2.4.3	NzShp = Noise Shape < 000-012 >.....	40
6.2.4.4	Gate < 000-127 >.....	41
6.2.5	<i>MB Page 3 B</i> .....	41
6.2.5.1	E1Amt = Envelope 1 Amount < 000-127 >.....	41
6.2.5.2	MtNz2 = Metal Noise 2 < 000-127 >.....	41
6.2.5.3	E2Amt = Envelope 2 Amount < 000-127 >.....	41
6.2.6	<i>MB Page 4 A</i> .....	42
6.2.6.1	L1Wav = LFO 1 Wave < 000-063 >.....	42
6.2.6.2	L1Rat = LFO 1 Rate < 000-127 >.....	42
6.2.6.3	L1Int = LFO 1 Intensity < 000-127 >.....	42
6.2.6.4	Vol = Volume < 000-127 >.....	42
6.2.7	<i>MB Page 4 B</i> .....	43
6.2.7.1	L2Wav = LFO 2 Wave < 000-063 >.....	43
6.2.7.2	L2Rat = LFO 2 Rate < 000-127 >.....	43
6.2.7.3	L2Int = LFO 2 Intensity < 000-127 >.....	43
6.2.7.4	Acc = Accent < 000-127 >.....	43
<b>7</b>	<b>SAMPLE BASED INSTRUMENTS</b> .....	<b>44</b>
7.1	SAMPLE ENGINE.....	44
7.1.1	<i>SMP Page 1 A (every sampling instrument including X Sample tracks)</i> .....	44
7.1.1.1	Pitch < 000-127 >.....	44
7.1.1.2	Start < 000-127 >.....	44
7.1.1.3	Stop < 000-127 >.....	44
7.1.1.4	Sample < 000-300 >.....	45
7.1.2	<i>SMP Page 1 B (every sampling instrument including X Sample tracks)</i> .....	45
7.1.2.1	Cents < 000-127 >.....	45
7.1.2.2	Loop < 000-127 >.....	45
7.1.2.3	LopOn = Loop On < 000/128 >.....	45
7.1.2.4	Revr = Reverse play < 000/128 >.....	45
7.2	SAMPLE ANALOG ENGINE.....	46
7.2.1	<i>SMP Page 2 A</i> .....	47
7.2.1.1	VCAAtt = VCA Attack < 000-127 >.....	47
7.2.1.2	VCDec = VCA Decay < 000-127 >.....	47
7.2.1.3	VCSus = VCA Sustain < 000-127 >.....	47
7.2.1.4	VCRel = VCA Release < 000-127 >.....	47
7.2.2	<i>SMP Page 2 B</i> .....	48

7.2.2.1	FiAtt = Filter Attack < 000-127 >.....	48
7.2.2.2	FiDec = Filter Decay < 000-127 >.....	48
7.2.2.3	FiSus = Filter Sustain < 000-127 >.....	48
7.2.2.4	FiRel = Filter Release < 000-127 >.....	48
7.2.3	<i>CH/OH Page 3 A (only Hi Hat Filter)</i> .....	49
7.2.3.1	LpCut = Low Pass Cutoff < 000-127 >.....	49
7.2.3.2	HpCut = High Pass Cutoff < 000-127 >.....	49
7.2.3.3	Res = Resonance < 000-127 >.....	49
7.2.3.4	Rout = Filter Routing < 000-001 >.....	49
7.2.4	<i>CH/OH Page 3 B (only Hi Hat Filter)</i> .....	50
7.2.4.1	LpCut = Low Pass Cutoff < 000-127 >.....	50
7.2.4.2	HpCut = High Pass Cutoff < 000-127 >.....	50
7.2.4.3	EvAmt = Envelope Amount < 000-127 >.....	50
7.2.4.4	NtNz = Metal Noise < 000-127 >.....	50
7.2.5	<i>SMP Page 3 A (only MM Filter Instruments Clap, Rim, Crash and Ride)</i> ..	51
7.2.5.1	Cutoff < 000-127 >.....	51
7.2.5.2	Res = Resonance < 000-127 >.....	51
7.2.5.3	EvAmt = Envelope Amount < 000-127 >.....	51
7.2.5.4	Rout = Filter Routing < 000-003 >.....	52
7.2.6	<i>SMP Page 3 B (only MM Filter Instruments Clap, Rim, Crash and Ride)</i> ..	52
7.2.6.1	Cutoff < 000-127 >.....	52
7.2.6.2	Res = Resonance < 000-127 >.....	52
7.2.6.3	EvAmt = Envelope Amount < 000-127 >.....	52
7.2.6.4	NtNz = Metal Noise < 000-127 >.....	52
7.2.7	<i>SMP Page 4 A (every sampling instrument including X Sample tracks)</i> ....	53
7.2.7.1	LFWav = LFO Wave < 000-063 >.....	53
7.2.7.2	LFRat = LFO Rate < 000-127 >.....	53
7.2.7.3	LFTun = LFO Sample Tune Amount < 000-127 >.....	53
7.2.7.4	Vol = Volume < 000-127 >.....	53
7.2.8	<i>SMP Page 4 B (every sampling instrument including X Sample tracks)</i> ....	54
7.2.8.1	LFsyn = LFO Synchronization < 000/128 >.....	54
7.2.8.2	LFVCA = LFO VCA Amount < 000-127 >.....	54
7.2.8.3	LFcut = LFO Cutoff Amount < 000-127 >.....	54
7.2.8.4	Acc = Accent < 000-127 >.....	54
7.3	<b>X SAMPLE INSTRUMENTS</b> .....	55
7.3.1	<i>X1/X2 Page 1 A</i> .....	55
7.3.1.1	Sample select X < RAM1, RAM2, 2-300 >.....	55
7.3.2	<i>Recording a Sample</i> .....	56
7.3.3	<i>Manually Recording a Sample</i> .....	57
7.4	<b>FM SYNTH</b> .....	58
7.4.1	<i>FM Synth modulation matrix</i> .....	58
7.4.1.1	FM Modulation Matrix Page A.....	59

7.4.2 FM Synth Operator Description.....	60
7.4.3 FM Synth Envelope Page B.....	61
7.4.3.1 EG1At = Sine Operator 1 Envelope Generator Attack <0-127>.....	61
7.4.3.2 EG1Rl = Sine Operator 1 Envelope Generator Release <0-127>.....	61
7.4.3.3 S1Amt = Sine Operator EG1 VCA Amount <0-127>.....	61
7.4.3.4 S1FM = Sine Operator EG1 FM Amount <0-127>.....	61
7.5 EFFECTS.....	62
7.5.1 Entering the FX page.....	63
7.5.2 Reverb Parameters Page 1 A.....	63
7.5.2.1 Reverb Room Size.....	63
7.5.2.2 Reverb Low Frequencies.....	63
7.5.2.3 Reverb High Frequencies.....	63
7.5.2.4 Reverb Level.....	64
7.5.3 Reverb Send KD, MB, CH, OH Page 2 A.....	64
7.5.3.1 Kick Drum Reverb Send.....	64
7.5.3.2 MBrane Reverb Send.....	64
7.5.3.3 Closed HiHat Reverb Send.....	64
7.5.3.4 Open HiHat Reverb Send.....	64
7.5.4 Reverb Send CLAP, RIM, CRASH, RIDE Page 3 A.....	65
7.5.4.1 Clap Reverb Send.....	65
7.5.4.2 Rim Reverb Send.....	65
7.5.4.3 Crash Reverb Send.....	65
7.5.4.4 Ride Reverb Send.....	65
7.5.5 Reverb Send X1, X2, FM, Rev on/off Page 4 A.....	66
7.5.5.1 X Sample 1 Reverb Send.....	66
7.5.5.2 X Sample 2 Reverb Send.....	66
7.5.5.3 FM Synth Reverb Send.....	66
7.5.5.4 Reverb on/off.....	66
7.5.6 Delay Parameters Page 1 B.....	67
7.5.6.1 Delay Time.....	67
7.5.6.2 Delay Feedback.....	67
7.5.6.3 Delay Spatial.....	67
7.5.6.4 Delay Level.....	67
7.5.7 Delay Send KD, MB, CH, OH Page 2 B.....	68
7.5.7.1 Kick Drum Delay Send.....	68
7.5.7.2 MBrane Delay Send.....	68
7.5.7.3 Closed HiHat Delay Send.....	68
7.5.7.4 Open HiHat Delay Send.....	68
7.5.8 Delay Send CLAP, RIM, CRASH, RIDE Page 3 B.....	69
7.5.8.1 Clap Delay Send.....	69
7.5.8.2 Rim Delay Send.....	69
7.5.8.3 Crash Delay Send.....	69

7.5.8.4 Ride Delay Send.....	69
7.5.9 <i>Delay Send X1, X2, FM, Rev on/off Page 4 A</i> .....	70
7.5.9.1 X Sample 1 Delay Send.....	70
7.5.9.2 X Sample 2 Delay Send.....	70
7.5.9.3 FM Synth Delay Send.....	70
7.5.9.4 Delay on/off.....	70
<b>8 SINGLE/MULTI MODE.....</b>	<b>71</b>
8.1 ACTIVATING SINGLE OR MULTI MODE.....	72
8.1.1 <i>Selecting an Instrument in Multi Mode</i> .....	73
8.1.2 <i>Editing and Storing Sounds in Multi Mode</i> .....	73
<b>9 DISK.....</b>	<b>74</b>
9.1 FILE FORMAT.....	74
9.2 LOADING SAMPLES FROM DISK.....	75
9.2.1 <i>Change and Open a Folder</i> .....	75
9.2.2 <i>Load a Sample into RAM</i> .....	76
9.2.3 <i>Load a Sample into Flash Memory</i> .....	76
9.3 SAVE RECORDING TO FILE.....	77
9.4 LOAD PRESETS FROM FILE.....	77
9.5 SAVE PRESETS TO FILE.....	78
9.6 LOAD SEQUENCE FROM FILE.....	78
9.7 SAVE SEQUENCE TO FILE.....	79
9.8 LOAD OS SYSTEM FILE.....	80
9.9 RESTORE ALL FLASH SAMPLES AND MEMORY.....	80
9.10 LOAD BACKUP FILE AND RESTORE PRESETS AND PATTERNS.....	81
<b>10 BPM/MIDI.....</b>	<b>82</b>
10.1 BPM <030-300>.....	82
10.2 MIDI SETTINGS.....	82
10.2.1 <i>ClkSync = Midi Clock Synchronization &lt;on/off&gt;</i> .....	82
10.2.2 <i>TxCk = Transmit Midi Clock &lt;on/off&gt;</i> .....	83
10.3 MIDI PAGE 2 MIDI ENABLES.....	83
10.3.1 <i>TxTrig = Transmit MIDI Note Triggers &lt;on/off&gt;</i> .....	83
10.3.2 <i>TxCC = Transmit MIDI Continuous Controllers &lt;on/off&gt;</i> .....	83
10.3.3 <i>RxTrig = Receive MIDI Note Triggers &lt;on/off&gt;</i> .....	84
10.3.4 <i>USBmidi = USB events to MIDI &lt;on/off&gt;</i> .....	84
10.4 MIDI PAGE 3 SYSEX DUMP FUNCTIONS.....	84
10.4.1 <i>DumpKit</i> .....	84



10.4.2 <i>DumpAllKits</i> .....	85
10.4.3 <i>DumpSeq</i> .....	85
10.4.4 <i>DumpAllSeq</i> .....	85
10.5 MIDI PAGE 4 SAMPLE SYSEX DUMP FUNCTIONS.....	85
10.5.1 <i>DumpSample</i> .....	85
10.5.2 <i>DumpAllSampl</i> .....	85
<b>11 THE SEQUENCER.....</b>	<b>86</b>
11.1 SELECTING PATTERNS.....	86
11.1.1 <i>Pattern Recall</i> .....	86
11.1.2 <i>Bank button</i> .....	86
11.1.3 <i>Chaining of Patterns</i> .....	87
11.2 PROGRAMMING OF PATTERNS.....	87
11.2.1 <i>Setting or Clearing Steps – Programming Beats</i> .....	88
11.2.2 <i>Setting/Clearing Accents</i> .....	88
11.2.3 <i>BAR Button &lt;A-D&gt;</i> .....	89
11.2.4 <i>Scale &lt;A-D&gt;</i> .....	89
11.2.4.1 <i>Editing Scale</i> .....	90
11.2.5 <i>Last Step &lt;1-64&gt;</i> .....	90
11.2.6 <i>A/B/C/D Copy function</i> .....	91
11.2.7 <i>Shuffle &lt;000-011&gt;</i> .....	92
11.2.8 <i>Roll/Flam</i> .....	92
11.2.9 <i>Store Pattern / Copy Function</i> .....	93
11.3 SEQ MODE.....	95
11.3.1 <i>Pitch Sequence</i> .....	95
11.3.2 <i>Parameter Locks</i> .....	96
11.3.2.1 <i>Setting p-locks</i> .....	96
11.3.2.2 <i>Setting Instrument Select as p-locks</i> .....	97
11.3.2.3 <i>Editing p-locks</i> .....	98
11.3.2.4 <i>Setting or Clearing p-locks</i> .....	99
<b>12 2ND FUNCTIONS.....</b>	<b>100</b>
12.1 <i>STORE KIT (1)</i> .....	100
12.2 <i>CLEAR PATTERN (2)</i> .....	101
12.3 <i>STORE PATTERN (3)</i> .....	101
12.4 <i>INIT KIT (4)</i> .....	102
12.5 <i>LAST STEP (5)</i> .....	102
12.6 <i>SHUFFLE (6)</i> .....	102

12.7 REALTIME WRITE (7).....	103
12.8 METRONOME (8).....	104
12.9 STEREO PANNING (9).....	104
12.9.1 Stereo Pan KD, MB, CH, OH Page 1.....	105
12.9.1.1 Kick Drum Pan <000-127, 63=Center>.....	105
12.9.1.2 MBrane Pan <000-127, 63=Center>.....	105
12.9.1.3 Closed HiHat Pan <000-127, 63=Center>.....	105
12.9.1.4 Open HiHat Pan <000-127, 63=Center>.....	105
12.9.2 Stereo Pan Clap, Rim, Crash, Ride Page 2.....	105
12.9.2.1 Clap Pan <000-127, 63=Center>.....	105
12.9.2.2 Rim Pan <000-127, 63=Center>.....	105
12.9.2.3 Crash Pan <000-127, 63=Center>.....	105
12.9.2.4 Ride Pan <000-127, 63=Center>.....	105
12.9.3 Stereo Pan X1, X2, X Input Mono/Stereo, Init Page 3.....	106
12.9.3.1 X1 Pan <000-127, 63=Center>.....	106
12.9.3.2 X2 Pan <000-127, 63=Center>.....	106
12.9.3.3 X Input Mono/Stereo <on/off>.....	106
12.9.3.4 Initialise Panning.....	106
12.9.4 Stereo Pan X1, X2, X Input Mono/Stereo, Init Page 4.....	107
12.9.4.1 FM Pan.....	107
12.9.4.2 FM Spatial.....	107
12.9.4.3 FM Number of Voices <001-006>.....	107
12.9.4.4 FM Volume.....	107
12.10 SCALE (10).....	107
12.11 A/B/C/D COPY (11).....	108
12.12 ROLL/FLAM (12).....	108
12.13 FX (13).....	109
12.14 SINGLE/MULTI MODE (14).....	109
12.15 MEMORY INIT (15).....	109
12.16 SHUT DOWN (16).....	110
<b>13 APPENDIX.....</b>	<b>111</b>
13.1 MIDI IMPLEMENTATION.....	111
13.1.1 Midi Note Commands.....	111
13.1.2 Program Change.....	112
13.1.3 Sound Parameter (Continuous Controllers).....	112
13.1.4 3. Sysex Commands.....	118

# 1 Introduction

Thank you for using the JoMoX ALPHA BASE!

We are pretty confident that that you'll have lots of joy and entertainment with this incredible sounding analog drum synthesizer!

## 1.1 A brief introduction to the ALPHA BASE

The ALPHA BASE is a drum machine with 11 instruments. Although it may appear similar to our classics XBASE 09, 999 and 888, the ALPHA BASE has an entirely new design under the hood. We have put in all the concentrated know-how of Jomox drum machines and our synths from the past 20 years, simplifying some things, but also adding new components or combining them anew. The outcome is the best sounding and most versatile drum machine that Jomox has ever built.

### 1.1.1 Kick Drum

The central instrument still is the analog kick drum which has received another facelift. The legendary punch and assertiveness of all Jomox kicks are convincingly continued. LFO, pitch envelope, metallic noise and gate time are famous, essential features that are very much emphatically there.

### 1.1.2 MBrane

As a second analog instrument, we have put in a complete MBrane voice. It covers a gigantic spectrum of analog snare drums, percussions, cow bells, claves, glasses, toms, bass drums etc. etc. It uses the technology of the Mod.Brane11. Of course, this instrument has 2 of its own LFOS, pitch envelopes and metallic noise as well.

### 1.1.3 Samples+Filter

The succeeding six instruments are built hybridly and consist of samples that are run through real analog filters and VCAs. Each analog sample channel has its own metallic noise that alternatively can be used as a signal source or be mixed to the sample. With metallic noise only, it becomes a pure analog instrument again. Four channels make use of a multimode filter that is capable of resonance - again they can be used as true analog instruments with the self-oscillating filter as the only sound source if you wish.

#### **1.1.4 Hi Hat**

Two of these six channels are reserved for Hi Hats and make use of a proven and improved HH filter already used in the XBASE 999. It is specialized for analog Hi Hats and can conjure brilliantly sounding Hi Hats from a sample mixed with metallic noise.

#### **1.1.5 Clap, Rim, Crash, Ride**

The succeeding four channels have each a resonance-capable 2-pole multimode filter that can be switched between LP, HP and BP. The filter cutoff can be modulated by an ADSR envelope and an LFO per instrument. If the filter is self-oscillating, one can create wonderful analog toms, claves, sticks etc. by means of the VCA envelope behind. Or even bend samples to their sonic limits. In principle, each of the four MM filter sample channels is a little synth voice on its own. A sampled synth bass run through the analog filter is nearly indistinguishable from a real analog synth.

#### **1.1.6 X Sample 1+2**

Moreover, there are two sample instruments that work purely digitally. It's even possible for Alpha Base to sample external audio on these channels for up to 5 seconds, which is more than enough for drum samples. The recorded sample can be stored on SD card or be copied to the internal flash memory and then be played back by the other sample channels. Samples can also be copied from SD card into flash memory. The format is RAW/WAV mono 16 Bit / 48kHz. The internal organization divides samples into fixed memory slots that can be addressed by the parameter sample select in the instruments. All samples can be pitched and modulated across a wide range. The sample start and stop points can be edited and samples are loopable as well. Modulation targets are: pitch, filter cutoff and volume, for which each channel has its own LFO.

#### **1.1.7 FM Synth**

As a little digital gadget we have added a mini FM synth. With 4 operators and maximum 6 voices it can create everything from weird and crazy percussion sounds down to simple chords. Played over an external midi keyboard, it can be used as a polyphonic synth.

### 1.1.8 Effects

Two digital effects are on board: delay and reverb that act as send/return effects. Each of the analog instrument outputs has an own A/D converter. The delay effect can also be inserted into the 6 hybrid sample channels to become part of the sound production chain. The reverb can easily be killed by an encoder click but is indeed a great advantage for live performances with minimal equipment. Reverb times can reach almost infinity, and the damping filters act emphatically so that the reverb meets the requirement of modern electronic music and can be an essential part of the sound.

### 1.1.9 Editing

For the editing of parameters there are 16 encoders arranged in a 4x4 matrix. Each instrument only comprises two pages of 16 values to make the editing as easy as possible, without deep menu cursors. The 24x2 character display can show 4 parameters at a glance.

### 1.1.10 Manual convention

In order to make this manual easier to understand, all user interface descriptions of the ALPHA BASE in the text following, are set into round brackets () and printed **bold**.

e.g.

*Press the **(KIT/SEQ)** button.*

Display contents and values are printed like this: < **000-127** >

## 2 Connection

Please use the ALPHA BASE in dry rooms only, with a temperature no higher than 35° C (95° F).

On the back panel of the casing you will find the following connections:

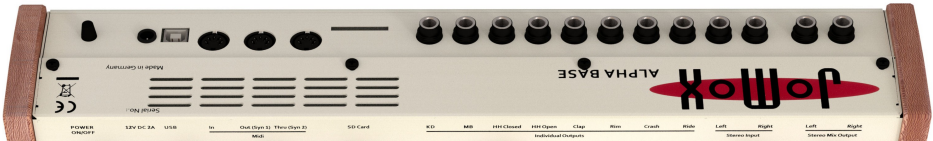

### 2.1.1 Power Supply

Please connect the provided wall wart adapter to the line and hook it up to the supply jack 12V= DC IN on the ALPHA BASE. If, for any reason, you are not able to use the original power supply, please use a DC adapter with 12 Volts and at least 2 amps. Never use an AC/AC adapter as the ALPHA BASE might get damaged!

### 2.1.2 Audio connections

Please turn off the ALPHA BASE and the mixer.

The ALPHA BASE has a stereo main output that mixes all instruments. If you plug in a cable to an individual output, this instrument is removed from the stereo mix.

All audio outputs including the individual outs are balanced and deliver a level of max 20dBu. Please connect the audio outputs with ¼" stereo audio cables to the audio inputs of your mixer. Most mixers can handle these balanced inputs.

### 2.1.3 USB Connection

The USB input is just used for Midi via USB. No drivers are needed as it uses generic drivers for Midi USB devices that are part of every modern computer OS. Just connect the Alpha Base with a normal USB cable to the computer, and the computer will recognize the USB device and install the driver automatically.

Please note that the Alpha Base is not USB powered and always needs to be turned on before a USB connection gets established.

Every instrument receives and transmits midi on its own channel in ascending order. It starts with the kick drum = CH 1 and ends with the FM synth = CH 11.

CH 16 is reserved as a global channel where the Alpha Base receives all instruments mapped on the keyboard. See Appendix for more information.

### **2.1.4 MIDI Connections**

The MIDI In jack of the ALPHA BASE is used for remote playing, controlling and synchronization by other MIDI capable devices like master keyboards and computers. You can use the Midi port alongside the USB port Midi.

» **Note:** *please only send as much Midi data as necessary. The more Midi data has to pass the MIDI cable the worse the timing gets. Use different Midi ports for different machines as the Midi protocol is serial and consumes time and performance. Please look at the Midi Implementation in the appendix about which Midi data is received and processed by the ALPHA BASE.*

Connect the MIDI In jack of the ALPHA BASE to the MIDI Out jack of the master by use of a midi cable.

### **2.1.5 MIDI OUT**

With MIDI Out the ALPHA BASE transmits midi data to other devices such as computers, synthesizers and others. Connect the MIDI Out jack of the ALPHA BASE to the Midi In jack of the other device.

### **2.1.6 MIDI Thru**

Midi data that is received on the MIDI In jack is forwarded to the MIDI Thru jack without being changed. More MIDI capable devices can be connected to this port.

### **2.1.7 Sync Out 1+2**

In the Midi jacks there is an old school Roland DIN Sync interface integrated in case someone has to synchronize an old TB-303 or the like. The sync lines are on pins that are not used by Midi. The output sync port appears on both Midi Thru and Midi Out. If you don't need one of them, use a regular Midi cable and connect it to the DIN sync input of your device. The ALPHA BASE provides a 5V Run/Stop and a 5V clock signal. A maximum of two units can be synced.

### **2.1.8 SD Card Slot**

The Alpha Base has an SD card port to upload or store samples. Please use the provided SD Card. The card must have a FAT32 file system, not exFAT32 as this is Microsoft licensed and not supported. Mostly smaller and slower cards up to 32-64GB make use of the FAT32 system.

The size can be as high as 8TB but the FAT32 file system is mandatory. File format is WAV 48kHz 16bit mono or RAW 48kHz 16bit mono. The Alpha Base only stores RAW files.



## 2.2 Quick Start

Connect the ALPHA BASE to an appropriate amplifier or to a mixer. Before you turn on, please turn the master level of your mixer or amplifier down. On initial boot up sequence, you are welcomed by the following display:

```

  JoMoX Music Tools
  Analog w/out compromises

```

```

  Presenting the wonderful
  ALPHABASE DRUM MACHINE

```

And ultimately:

```

AlphaOne 000           120.0
████████████████████

```

Press the **(Start)** button to start the sequencer. Now you can adjust the Mix Volume or the Phones knob to a convenient volume.

### 2.2.1 First Steps

Let's program the first self-created drum pattern. Switch to bank 2 by pressing the **(BANK)** button. By pressing **(Step 1)** button choose the first empty pattern. Now enter the edit mode by pressing **(EDIT/TRIG)** and select an instrument track by pressing the corresponding instrument key, e.g. the kick drum track.

Start the sequencer and press some desired **(Step)** buttons (= one 16<sup>th</sup> note) in the current track. The step is played when the running LED spot comes across. Pressing again erases the step again. Complete your instrument rhythm and switch to another instrument and select steps to be played there too and complete your own drum pattern by layering several instruments in a rhythmic pattern.

If you want to set an accent, hold the instrument key and press the step button at the same time so that the formerly red step LED turns orange. They are lit orange to indicate that an accent is played on this step. If you want to unset an accent, do the same again and the orange LED turns red.

You can adjust the accent level of any instrument if you switch the **(PAGE)** button to page B and turn the rightmost lowest encoder 16. With Acc = 0 there is no difference between accent or non-accent, with Acc = 127 the difference is at maximum.

If you are ready with your rhythmic pattern, let's add a little melody to the different instruments. Press the **(SEQ)** button to enter pitch sequence mode, the display shows:



See that the sequencer spot LED also runs through the 4x4 knob matrix, indicating the knob of the step that is currently played. The LED next to the knobs of steps set lights up red. You can change the tuning for those steps by turning the knobs. This will be displayed in the LCD. Every pixel resembles a semitone (except Kick and Mbrane).

Now you can go through the different instruments and create melodies for the bass drum or make melodies on the clap sound or whatever you like.

If you want to edit the sounds of the instruments again or even want to change the kit preset, just flip to parameter mode, kit select or pitch sequence mode by pressing the **(KIT/SEQ)** button several times.

If you press **(SEQ)** again (SEQ=off), the melodies turn off and the Alpha Base just plays the internal pitch of every instrument.

If you like the pattern, you should store it to memory. Unless you store it - all editings are only made in the edit buffer - it will be gone when you select another pattern. Press and click **(Knob 15)** to quick-store a pattern to RAM.

For long-term storage, press **(Shift/Cancel)**, then **(Step 3)** = Store Pattern.

Enjoy and check it out!

In the following short paragraphs of the quick start guide the basic functions are described:

### 2.2.2 Select Presets:

The **(KIT/SEQ)** button switches between preset selection and parameter mode. In Kit select mode, use the **(Data)** wheel or the **(Up/Down)** buttons to select a kit and load it by clicking **(Data)** wheel or the **(Enter)** button.

### 2.2.3 Select Patterns:

Whilst EDIT/TRIG LED is off, press one of 16 step buttons to select a pattern. Use the bank button to select one of 4 banks. In the factory settings, banks 2-4 are empty.

### 2.2.4 Select Instruments (=tracks):

Press **(EDIT/TRIG)** (LED = on) and press an instrument key to select the track. The instrument/track LED lights up, indicating the currently selected track.

Press **(EDIT/TRIG)** again (LED = off) and trigger the instrument with the key button.

### 2.2.5 Mute Instruments:

Click on the encoder knobs that correspond to the instrument (1=Kick, 2=MBrane, 3=CH aso.). If the LED blinks, the instrument is muted. Press again to unmute.

### 2.2.6 Edit Instrument:

Turn the desired encoder knob – the parameter of the currently selected instrument gets changed. One row of 4 parameters is displayed. The rows switch automatically when a knob is turned. Press the **(PAGE)** A/B button to reach the second set of parameters (max 32 per instrument). When in parameter mode (KIT/SEQ = not kit select), the right/left buttons switch between the rows of parameters and show the actual parameters.

### 2.2.7 Store Kit Preset:

Press and click **(Knob 16)** to quick-store to RAM.

The RAM stores all presets and patterns temporarily. In order to keep the edited data after next power cycle, you have to transfer the data to flash memory. This is made with shift 1 (Store Preset). However, due to the internal structure, all digital instruments must be muted during the programming cycle, although the sequencer keeps on running. So, for transparent work-flow, use the quick-store function during work-in-progress and do not forget to store to flash memory with shift 1 before turning off.

### 2.2.8 Store Pattern:

Press and click **(Knob 15)** to quick-store a pattern to RAM.

The same considerations as with Preset Store apply here (see above), just use Store Pattern (shift 3) to transfer to flash memory.

### 2.2.9 Edit Tempo:

Press **(BPM/MIDI)** and change the tempo with the **(Data)** wheel.

### 2.2.10 Edit Patterns:

Whilst in Edit Mode ( EDIT/TRIG LED=on), set the notes with the 16 step buttons of the desired 16<sup>th</sup> to be played in a measure. Press **(Start)** to start the sequencer, and the running LED spot shows the currently played step.

### 2.2.11 Set/Clear Accents:

Hold the instrument key and press the step button at the same time. The color changes from red to orange=accent or vice-versa. All instruments have an individual accent level that defines how strong the accent is played.

### 2.2.12 Select Bar (Measure):

The instrument tracks can be as long as 64 steps. Whilst in Edit mode, use the **(BAR)** button to switch between bars of each 16 steps. The last step value (1-64) of the instrument track limits the number of bars to select. The LED of the currently played bar will blink.

### 2.2.13 Pitch Sequence:

Press the **(SEQ)** button (LED = on). Now the pitch of every instrument is being played by the sequencer. The bars in the LCD mark the pitch change, the crossed steps are not played. Turn the corresponding knobs of the 4x4 knob matrix to change the pitch of the played step. Every pixel resembles a semitone. You can add pitch of up to 2 octaves higher than the original tuning.

Flip between sequencer mode, parameter mode and kit select mode with the **(KIT/SEQ)** button.

### 2.2.14 Editing Sample based instruments

If you are editing a sample based analog instrument (CH to RIDE), select the sample with knob 4 = Sample Select. If Sample Select = 0, the sample is off. The sample is always routed through an analog VCA with its own envelope. Filter Routing (knob 8 page A) decides if the sample and metal noise are routed through a filter. If Rout = 0, no filter and no metal noise are applied and only the sample passes through the VCA. If Filter Rout > 0 and Sample Select = 0, the VCA envelope just plays back metal noise (knob 8 page B) or self-oscillating filter tones. If Metal Noise = 0, noise is off. Metal Noise = 1 is always white noise. If both Metal Noise and Sample Select are > 0, they are mixed together.

## 3 The User Interface

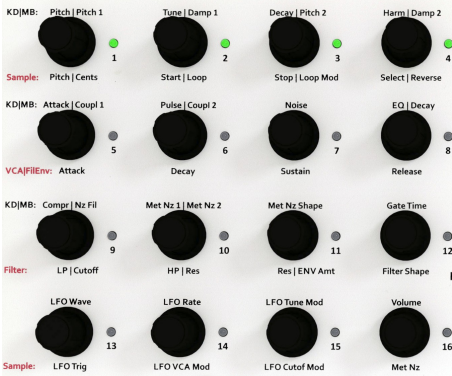

### 3.1 Encoder Matrix and LEDs

In edit mode, the 4x4 encoders are assigned to the different parameters of the currently selected instrument. Most parameters are printed on the case.

#### 3.1.1 Muting Instruments/Encoder Click

All endless encoders provide a click (press) function which is firmly assigned to the mute function or some other special function with direct access (see \*). At any time and in any mode, you can mute the instruments by clicking on one of the encoders 1-11.

When an instrument is muted, the LED next to the encoder blinks red.

(\* these are: 12= Single/Multi switching, 13= P-lock on/off, 14= FX Kill, 15= Pattern quick store, 16= Preset quick store).

## 3.2 Analog Controls

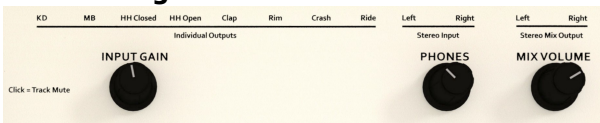

#### 3.2.1 Input Gain

With this knob the input gain of the external input can be adjusted.

#### 3.2.2 Phones

This knob controls the phones volume of the front headphone jack.

#### 3.2.3 Mix Volume

This knob controls the volume of the stereo mix output. The individual outputs are not affected by this potentiometer.

### 3.3 Menu Controls



#### 3.3.1 DATA

This knob is used for selecting kits or editing of parameters that are chosen by the **(LEFT)** and **(RIGHT)** cursor buttons.

The **(Data)** wheel has a click function that loads a selected kit or loads a chosen sample, depending on the menu that is currently selected.

#### 3.3.2 LEFT/RIGHT

These cursor buttons are used for navigation within the display menus.

#### 3.3.3 KIT/SEQ

This button switches between Kit select mode, parameter mode and sequencer mode (if SEQ is on). In Kit select mode, use the data encoder or **(Up/Down)** buttons to select a kit and load it with data click or enter.

#### 3.3.4 DISK

This button opens the disk menu and reads the directory of an inserted SD card.

#### 3.3.5 BPM/MIDI

This button opens the BPM/Midi menu. The first selected item is always BPM control.



### 3.3.6 BANK 1 - 4

The bank button cycles between 4 pattern banks.

### 3.3.7 PAGE A/B

This button switches between the two parameter pages A and B.

### 3.3.8 BAR A, B, C, D

This button switches between bars (measures) of 16 steps of a track. Only the currently selected bar of the whole track can be edited by the step buttons.

If the track length (Last Step) exceeds 16, the **(BAR)** button switches to the next bar and the step LEDs show the programming of the pattern in that bar. If Last Step  $\leq$  16, only BAR A can be chosen, if Last Step  $\leq$  32, A and B are selectable, if Last Step  $\leq$  48, A,B and C are selectable and with Last Step  $>$  48 all four bars A,B,C,D can be chosen.

If the sequencer is running, the currently played bar will blink in quarters of the down beat. The currently selected bar blinks more intensely to show which bar is selected for editing.

With this function you can always see which bar is currently playing.

## 3.4 Sequencer/Edit Controls



### 3.4.1 SEQ

This button activates the sequence mode. In sequence mode, the instruments are played back with different notes (pitch) per step, according to the programming. Also dynamic parameter locks are played back if this function is activated.

If **(SEQ)** is off, the machine just triggers every instrument like a classic drum machine without melodic pitch or p-locks.

### 3.4.2 CHAIN

This button activates the chaining of consecutive patterns to be played in a sequence.

### 3.4.3 X-REC

This button activates the recording mode for sampling from external input.

### 3.4.4 EDIT/TRIG

This button activates the edit mode in which an instrument/track can be selected and steps of a sequence pattern edited.

### 3.4.5 DOWN/UP

These buttons do the same as the **(DATA)** encoder for a selected menu. This is especially useful if you only want to change single steps of a value. In kit select mode, you can go up/down through the different kits and load them by pressing **(Enter)**.



## 3.5 Step Sequencer Controls

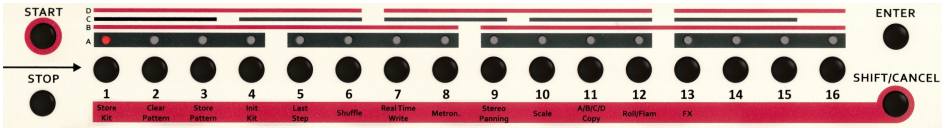

### 3.5.1 Start

This button starts the sequencer.

### 3.5.2 Stop

This button stops the sequencer.

### 3.5.3 Enter

This button has to be pressed to enter the various settings.

### 3.5.4 Shift/Cancel

By pressing this button you can reach the 2nd functions of step buttons 1..16. Also used for cancelling functions.

### 3.5.5 Scale Stripes

The red or black horizontal stripes marked with A, B, C and D, to the left of the **(Start)** button, indicate the quarter downbeats of the selected scale. The scale determines if steps are played as straight notes or triplets.

### 3.5.6 Step 1-16 buttons and LEDs

Rhythm patterns are programmed and selected using the 16 step buttons. Furthermore, in conjunction with the **(Shift/Cancel)** button, they provide the 2<sup>nd</sup> functions indicated on the red strip running under the numbers.

### 3.5.7 Instrument Keys

These keys are used for the triggering and selection of instruments.

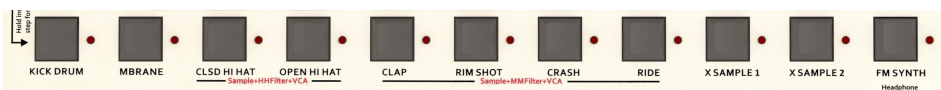

## 4 KIT/SEQ

The **(KIT/SEQ)** mode is used for the selection and naming of drum kits or parameter display or pitch sequencer display (if SEQ is on).

### 4.1 Select a drum kit:

The **(KIT/SEQ)** button switches between Kit select mode and parameter mode.

#### 4.1.1 Kit Select Mode

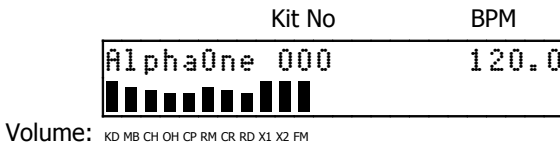

The height of the bars show the volume of the instruments in ascending order from left to right.

In Kit select mode, use the **(DATA)** wheel or the **(UP/DOWN)** buttons to select a kit and load it by clicking **(DATA)** or pressing **(ENTER)**.

You can select 127 different drum kits.

One Drum Kit contains a set of all sound parameters of all instruments.

One Multi Kit contains a vector set of 11 different instrument numbers that are stored in the single Drum Kit that the 11 individual numbers address.

#### 4.1.2 Parameter Mode

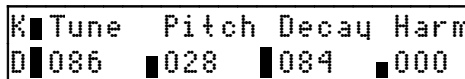

The height of the bars show the amount of the right-handed parameter.

If you are in Kit select mode and turn one of the 16 endless encoders, the menu automatically switches to parameter mode. If you now want to select a kit, you have to press **(KIT/SEQ)** again to re-enter Kit select mode.

## 4.2 Naming of a Kit

Switch **(KIT/SEQ)** to Kit select mode. Move the cursor to the right, and the display shows



AlphaOne 000 Edit..120.0

Turn the **(Data)** wheel (or use the **(Up/Down)** buttons) to change the letter above the cursor.



ElphaOne 000 Edit..120.0

Move the cursor on and do so until your desired name is complete.

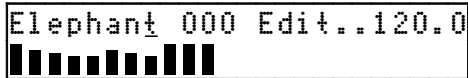

Elephant 000 Edit..120.0

Don't forget to store the preset by pressing encoder 16 (quick store), or everything will disappear when you select another kit. Leave the name edit mode by pressing the left cursor until "Edit.." disappears and you will return to preset selection level.

## 5 Editing

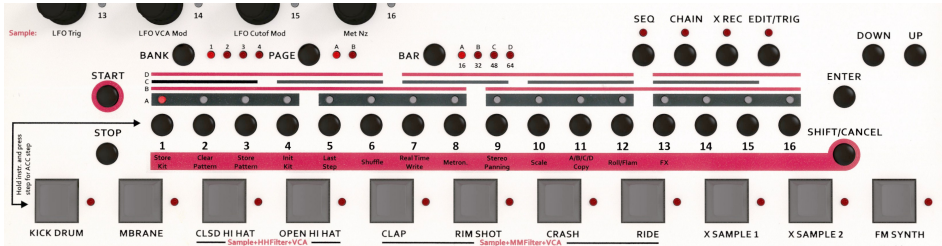

### 5.1 Select an Instrument

Press **(EDIT/TRIG)** to enter edit mode (LED = on) and select the desired instrument/track by pressing one of the 11 instrument keys. The LED next to the instrument key lights up and indicates that this track is now active. The sequencer step LEDs of this track are shown as well.

### 5.2 Play an Instrument

If you set **(EDIT/TRIG)** to off, the instrument can be triggered by the instrument keys. The active instrument can be edited until you select another one.

### 5.3 Edit an Instrument

In edit mode the **(Edit Encoders)** are assigned to instrument parameters. Turn the desired encoder knob – the parameter of the currently selected instrument gets changed. One row of 4 parameters is displayed at a time. The rows switch automatically when a knob is turned. The LCD display shows the current set of parameters corresponding to the row of four. The LEDs of the selected row light up green.



Press the **(Page) A/B** button to reach the second set of parameters (max 32 per instrument), and the row of 4 selected LEDs turns red, indicating page B. When in parameter mode (**KIT/SEQ** = not kit select), the right/left buttons switch between the rows of parameters and show the actual parameters.

## 6 Analog Instruments

### 6.1 Kick Drum

#### 6.1.1 KD Page 1 A = Page 1 B

K	Tune	Pitch	Decay	Harm
D	086	028	084	000

##### 6.1.1.1 Tune < 000-127 >

This parameter controls the intensity of the attack tune envelope. On a synthesizer this would be the pitch envelope modulation amount (Attack=0, Decay fixed value) of the VCO. A high value makes the typical 909 kick-in-the-gut effect, and a low value makes softer, 808-styled kick drums and bass tones.

##### 6.1.1.2 Pitch < 000-127 >

This parameter controls the basic pitch of the kick drum. Sub basses down to 10 Hz or relatively high tones are possible. Don't confuse this with the Tune parameter. With most kinds of instruments this parameter is called "tune", but because everybody knows the TR-909 and its specific tune, we called it pitch. The pitch is the base frequency which the VCO reaches when the tune envelope has decayed.

##### 6.1.1.3 Decay < 000-127 >

Controls the decay time (length) of the kick drum.

##### 6.1.1.4 Harm = Harmonics < 000-127 >

Control of harmonics of the VCO. The almost sinusoid waveform of the kick drum oscillator can be continuously shaped into a parabolic waveform. That results in a harder, timpani-like sound that differs clearly from a simple distortion.

**6.1.2 KD Page 2 A**

K	Attck	Pulse	Noise	EQ
D	086	028	084	007

**6.1.2.1 Attack < 000-127 >**

Important for the understanding of the bass drum attack section is the following: Pulse and noise are mixed together and the mix signal is controlled by attack intensity. If attack is cranked down, you won't notice any change on pulse or noise.

So you can program bass drums without any attack, or only pulse or only noise, or just with the mix of both.

**6.1.2.2 Pulse < 000- 127 >**

Change of the pure pulse part of the attack (see also attack parameter). Pulse is a clicking pulse-shaped waveform at the start of the kick drum which goes to the VCA. The sound of the pulse is strongly affected by the gate time (see also Gate Time) which determines the "energy" of the pulse and therefore the frequency spectrum of the first attack.

**6.1.2.3 Noise < 000-127 >**

Change of the pure noise part of the attack (see also attack parameter). Noise makes a more clap-like (or wet) sound in the attack. Please note that either the gate width (duration of the noise part) and the EQ parameter also affect this sound. With high EQ values you will hardly hear or not hear the noise part of the kick drum, because the high frequencies of the noise are filtered by the EQ. On the Alpha Base, the sound of the noise signal is significantly affected by parameter MetNze because the noise can be assembled by metallic high pitch tones.

**6.1.2.4 EQ < 000- 127 >**

Smooths the output of the kick drum sound production with a flat slope filter. With a value of <000>, the filter is opened at maximum; at <127> closed at maximum. The filter is optimized to achieve soft sounding 808ish sinusoid soft clicking kick drums (high EQ) vs heavy punchy hard drums (low EQ).

*Note: changes of the noise parameter can only be heard with an opened filter (low EQ).*

### 6.1.3 KD Page 2 B

K	PtAtk	PtDec	Noise	EQ
D	086	028	084	007

#### 6.1.3.1 PtAtk = Pitch Attack < 000-127 >

Controls the attack of the extra software pitch envelope.

#### 6.1.3.2 PtDec = Pitch Decay < 000- 127 >

Controls the decay of the extra software pitch envelope. This results in very slow and smoothly decaying kick drums. It is useful for 808-ish sounding drums. The software envelope amount is controlled by 4.1.3 EVAmt.

The rest of the parameters on this page are identical to page A.

**6.1.4 KD Page 3 A = Page 3 B**

K	Compr	MetNz	EVAmnt	Gate
D	086	028	015	023

**6.1.4.1 Compr = Compression < 000-127 >**

The compression parameter changes the loudness envelope during the decay phase of the kick drum. So the decaying sound can only have a very low level if this parameter is set high. This is useful, for instance, to adapt the "belly" of the kick drum to the mix or the room acoustics. At very high levels the envelope of the kick drum is cut so strong that very short and clicky kick drums are possible.

**6.1.4.2 MetNz = Metal Noise < off/noi-127 >**

The kick drum has its own noise generator. The parameter changes the noise to a metallic noise which consists of periodic asynchronous bit patterns. With <000> the noise generator is turned off, <001> yields a static random noise (white noise). On values above that <2-127>, a complex signal formed from digital multitones and bit patterns is produced. Each value represents a unique sound pattern which does not change smoothly across the range but jumps to various sounds one by one, akin to a kaleidoscope rather than a linear scale. You can get interesting results with any adjustment, so play the game of trial and error! Metallic Noise yields a quite aperiodic signal which results in noise-like sounds but with tone-like structures within. Tip: The noise signal is only audible during the gate period of the attack and is strongly affected by the gate time and EQ filtering. By tweaking these parameters, you can modulate the attack of the kick drum very finely and precisely.

**6.1.4.3 EVAmnt = Envelope Amount < 000-127 >**

On the Alpha Base, the kick drum VCO has gotten a second software generated pitch envelope in order to generate 808-ish softer kick drums. This parameter controls the amount of this pitch envelope. The shape of the envelope can be edited on page B.

**6.1.4.4 Gate < 000-127 >**

Controls the gate time, i.e. the impulse length of the trigger pulse for the analog kick drum circuitry. It can be adjusted from 0.1ms to 15ms. This parameter is very influential on the sound of the attack and the decaying tone. The shorter the gate time, the higher the frequencies contained in the spectrum of the attack but the less energy put into the envelope.



**6.1.5 KD Page 4 A**

K	LFWav	LFRat	LFInt	Vol
D	001	010	005	127

**6.1.5.1 LFWav = LFO Wave < 000-063 >**

Selects the LFO (Low Frequency Oscillator) Waveform. The LFO is used to modulate the pitch of the kick drum VCO. By default, the Alpha Base contains a set of 64 LFO Waveforms. The first 16 waveforms are: saw +/-, triangle +/-, sine +/-, rectified sine +/-, first halfwave sine +/-, second halfwave sine +/-, faded sine +/-, rectangle +/-.

The factory LFO wave set is contained in ABWV0300.raw. As the LFO waveforms are short samples, the user can theoretically create his own LFO waveforms. One has to edit the waveforms with a sample-precise wave editor. Each waveform is exactly 256 samples long. How to upload them is described in section DISK.

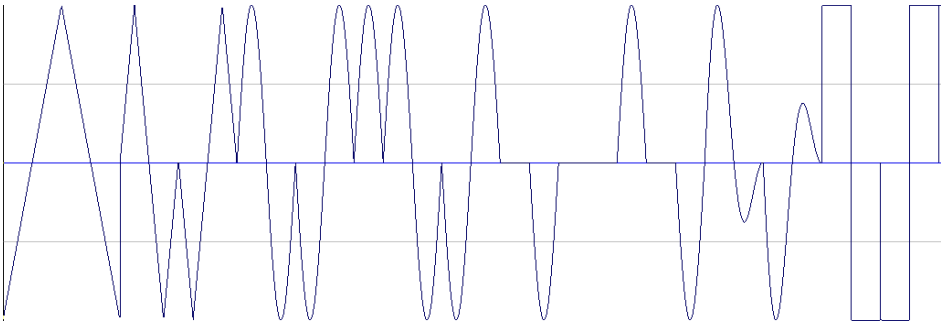
**6.1.5.2 LFRat = LFO Rate < 000-127 >**

LFO Rate controls the speed of the LFO.

**6.1.5.3 LFInt = LFO Intensity < 000-127 >**

LFO Intensity controls the amount of modulation. Zero turns the modulation off.

**6.1.5.4 Vol = Volume < 000-127 >**

Controls the volume of the instrument.

**6.1.6 KD Page 4 B**

K	LFWav	LFRat	LFInt	Acc
D	001	010	005	127

**6.1.6.1 Acc = Accent**

**< 000-127 >**

Accent determines how hard the instrument is played when an ACC is set in the sequencer. The maximum accent level also depends on the volume of the instrument. The volume defines the absolute maximum level that is played if accent is set to <127>, whereas lower accents adjust the dynamics in the range between the two values (no ACC = volume/2) and (ACC = volume/2 + accent).

## 6.2 MBrane

The MBrane is a great sounding, dedicated percussion module with a real analog sound production. Actually it is a single voice storable analog synthesizer which is optimized to produce a multitude of percussion and snaredrum-like sounds.

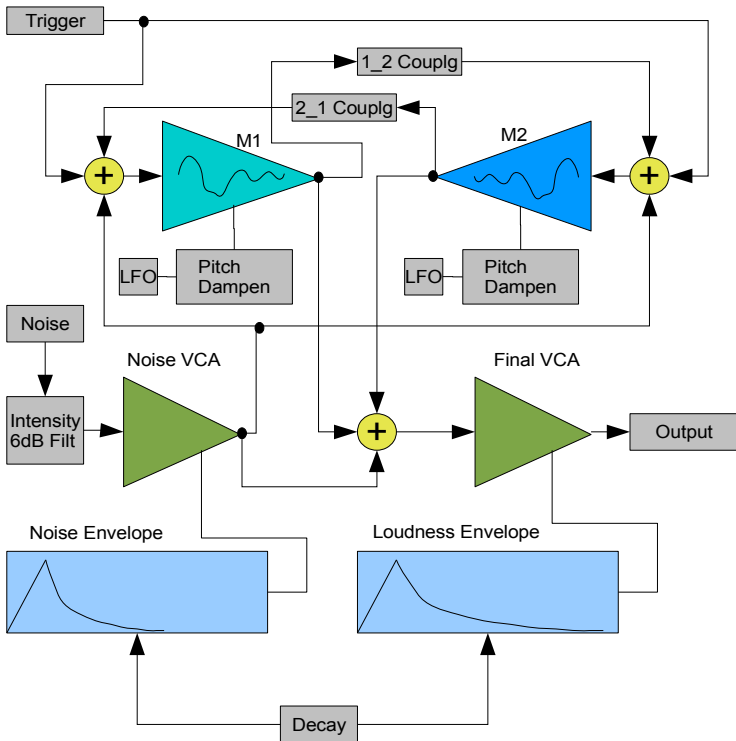

The sound production in the MBrane is made up of 2 filter oscillators (M1 and M2) that have the same frequency range of 25Hz - 14kHz.

A filter oscillator (F-OSC) is actually something like a multimode band pass filter which works close to the resonant frequency.

Because the F-OSC becomes an actual sine oscillator with increasing resonance, we call the deviation of ideal resonance Dampen. Then the resonating filter oscillator decays in form of an attenuated vibration if it's excited - similar to a single membrane that is hit.

In the MBrane there are two such F-OSC. With a strong Dampen the F-OSC really becomes a continuously vibrating oscillator. The weaker the Dampen is, the more the F-OSC becomes a filter with sharp q-factor (quality). This can be useful at e.g. snare drums or HiHat-ish sounds.

Looking at the drumskins of an acoustic drum, there are 2 membranes positioned that modulate and interact with each other by the coupling through pressure waves of the content air. That produces the typical sound of a drum. By resonance and counteractive interference of waves, new frequency bands and overtones are created.

The parameter Coupling works in a similar way in the MBrane. Both, in the first place independently vibrating F-OSCs, can attenuate or gain the vibration of the partner by means of coupling either way (1\_2 and 2\_1). With lightfingered tweaking you get these interesting membrane-like dampened sounds, especially by cross-wise positive/negative coupling. In order to obtain such a phase-wise cross coupling, the parameter 2\_1 Coupling provides negative values too and has a phase flipping circuitry built in. Furthermore, a slight frequency modulation is provided with every coupling parameter (M1 → M2 and M2 → M1) that makes the cross modulation sound even more natural and interesting.

In order to create snaredrum - or cowbell-like sounds, the MBrane has a noise generator with its own envelope. A part of this signal is fed into the F-OSC network to excite the "membrane" with the noise signal itself. Another part of the noise signal is mixed into the final VCA (Voltage Controlled Amplifier) which produces the overall volume envelope of the resulting instrument. The noise can be either white noise or metallic noise, which is a binary pattern of different metallic sounding frequency bands. In the Mod.Brane 11, there are two independent noise generators which can be mixed together.

The length of noise decay and the decay of the resulting tone are controlled by two different envelopes that are commonly controlled by the parameter Decay. The noise envelope is always shorter than the final VCA envelopes. That lets you work out the precise noise attacks by tweaking the Decay. The F-OSC's mostly have their own decay themselves (changed by Dampen), and they only sometimes need their own (and then longer) loudness envelope.

Two independent LFOs can modulate each of both F-OSCs or not. They always restart with the note trigger and work like an additional pitch envelope.

**6.2.1 MB Page 1 A**

M	Pitc1	Damp1	Pitc2	Dmp2
B	086	035	104	035

**6.2.1.1 Pitc1 = M1 Pitch < 000- 127 >**

This parameter controls the pitch of the first membrane oscillator M1 (F-OSC). The range goes from about 25Hz to 14kHz.

Please note that the pitch is also a little affected by the settings of M1 Dampen and both coupling parameters 1\_2 Couplg and 2\_1 Couplg. Because of the sensitive analog circuitry, these values interfere with each other a little bit so that re-adjustment of values may be necessary to achieve a special sound.

**6.2.1.2 Damp1 = M1 Dampen < 000-127 >**

With the parameter M1 Dampen you change the decay of sound, meaning the Dampen of F-OSC M1. If turned up, M1 fades longer and becomes a steadily vibrating oscillator. A low value makes the F-OSC M1 decay very short.

**6.2.1.3 Pitc2 = M2 Pitch < 000-127 >**

This parameter controls the pitch of the second membrane oscillator M2 (F-OSC). The range goes from about 25Hz to 14kHz. Other than that, the same qualities apply as described in 4.1. M1 Pitch.

**6.2.1.4 Damp2 = M2 Dampen < 000-127 >**

By the parameter M2 Dampen you change the decay of sound, means the Dampen of F-OSC M2. Other than that, the same qualities apply as described in 4.2. M1 Dampen.

## 6.2.2 MB Page 2 A

M	Cupl1	Cupl2	Noise	Decy
B	086	035	104	035

### 6.2.2.1 Cupl1 = Coupling 1->2 < 000-127 >

This parameter determines the coupling between M1 and M2. As mentioned in the general functional description, you can simulate the actions of two coupled membranes in a real drum. The parameter 1\_2 Coupling adds a part of the bandpass output of M1 to M2 and performs a little bit of frequency modulation too.

### 6.2.2.2 Cupl2 = Coupling 2->1 < 000-127 >

This parameter determines the coupling between M2 and M1. This value can be either positive or negative (offset 64). This controls at which phase (+/-) the bandpass signal is coupled (added) from M2 into M1.

64 is the initial setting at which no interference occurs. If both coupling parameters have the same sign, they gain each other and create a feedback vibration of both F-OSC which sometimes can result in scream-like sounds if both F-OSCs have the same pitch or are in an octave or 5th relation. At opposing signs, they attenuate each other. Like 1\_2 Coupling, 2\_1 Coupling performs a little frequency modulation M2 -> M1 too. By playing with these two parameters you can create those wave interferences and interactions that are characteristic of membrane-like percussion sounds.

### 6.2.2.3 Noise < 000-127 >

The noise signal creates the snare drum noise or metallic attacks. The parameter Noise controls the intensity of this signal. As can be seen in Pic.1, the noise signal is processed by a noise envelope and is then mixed into the F-OSC network and a small portion into the final VCA.

In the F-OSC network, the noise mixes up with the hit (trigger pulse) and the F-OSC sounds in a similar way to a real snare drum and reaches a fairly homogeneous sound. If Noise is cranked up too much (>180) it may lead to internal distortions that might, nevertheless, be desired. In addition, the level and sound of the noise are affected by the noise filter settings (see 5.3 Noiz Fil).

The noise may be either random white noise (MetNze 1 = <noi>) or metallic noise made up by thousands of combinations of MetNze 1 and/or MetNze 2.

**6.2.2.4 Decay < 000-127 >**

Controls the decay time (length) of the Mod.Brane 11. As can be seen in chapt. 6.9 functional description Pic.1, this value controls either the noise envelope and the final VCA envelope. The noise envelope is always shorter than the final VCA envelope in order to precisely adjust the noise attacks, whilst the decay of F-OSC M1 and M2 are mostly controlled by parameter Dampen.

**6.2.3 MB Page 2 B**

M	P1Atk	P1Dec	P2Atk	P2Dc
B	086	035	104	035

**6.2.3.1 P1Atk = Pitch1 Attack < 000-127 >**

For a simple pitch envelope that changes the pitch over time. This parameter controls the attack of this software-driven pitch envelope for F-OSC 1.

**6.2.3.2 P1Dec = Pitch1 Decay < 000-127 >**

This parameter controls the decay of this software-driven pitch envelope for F-OSC 1.

**6.2.3.3 P2Atk = Pitch2 Attack < 000-127 >**

For a simple pitch envelope that changes the pitch over time. This parameter controls the attack of this software-driven pitch envelope for F-OSC 2.

**6.2.3.4 P2Dc = Pitch2 Decay < 000-127 >**

This parameter controls the decay of this software-driven pitch envelope for F-OSC 2.

**6.2.4 MB Page 3 A**

M	NzFil	MtNz1	NzShp	Gate
B	086	035	104	035

**6.2.4.1 NzFil = Noise Filter < 000-127 >**

After the noise level control there is a simple 6 dB/octave low pass filter which can make the noise a bit more dull. A strong filtering of noise with a 6 dB/octave filter is also known as "pink noise". The noise loses its sharpness if you lower this value. At <127> the filter is opened and lets all high frequencies pass through with a slight mid-peak at 4kHz.

At <000> the noise signal is turned off.

**6.2.4.2 MtNz1 = Metal Noise 1 < 000-127 >**

Metallic noise 1 is one of two noise generators which offers a more periodic (tone-like) metallic noise algorithm. The basic character of noise 1 can be varied a lot by an adjustable bit mask (which applies only to noise 1).

Both noise generators get mixed by hardware. Therefore the noise level increases significantly if both noise generators are on. The signals interfere and then produce new noise patterns. The parameter changes the noise to a metallic noise which consists of periodic asynchronous bit patterns. With <000> the noise generator is turned off, <001> produces a static random noise (white noise).

On values above that <2-127> a complex signal formed from digital multitones and bit patterns is produced. Each value represents a unique sound pattern which doesn't change smoothly across the range but jumps to various sounds one by one, more akin to a kaleidoscope than a linear scale. They give you interesting results for any adjustment, so play the game of trial and error!

Metallic Noise 1 is more periodic and has an adjustable bit mask.

Metallic Noise 2 yields a more aperiodic signal which results in more noise-like sounds. This is useful for eg. cowbell-like sounds.

**6.2.4.3 NzShp = Noise Shape < 000-012 >**

This parameter defines the bit mask for noise generator 1. Small values produce very high frequencies in combination with the metallic noise 1 parameter, high values produce longer periodic signals. To hear changes on this parameter please check that metallic noise generator 1 isn't turned off. With low values for bit mask some numbers of metallic noise may produce silence by phase cancellation or may sound the same with every consecutive number so that only the lower numbers are relevant.



**6.2.4.4 Gate****< 000-127 >**

The gate time, i.e. the impulse length of the trigger pulse for both the membrane circuitries M1 and M2 can be adjusted from 0.1ms to 15ms.

This parameter is very influential on the sound of the attack and the decaying tone. The shorter the gate time, the higher the frequencies contained in the spectrum of the attack, though less energy is put into membrane circuitries causing a weaker and shorter envelope.

**6.2.5 MB Page 3 B**

M	E1Amt	MtNz2	E2Amt	Gate
B	086	035	104	035

**6.2.5.1 E1Amt = Envelope 1 Amount < 000-127 >**

For a simple pitch envelope that changes the pitch over time. This parameter controls the amount of this software-driven pitch envelope for F-OSC 1.

**6.2.5.2 MtNz2 = Metal Noise 2 < 000-127 >**

Metallic noise 2 is the second of the two noise generators. The parameter changes the noise to a metallic noise which consists of periodic asynchronous bit patterns.

With <off> the noise generator is turned off, <noi> yields a static random noise (white noise).

On values above that <2-127> a complex signal formed from digital multitones and bit patterns is produced. Each value represents a unique sound pattern which doesn't change smoothly across the range but jumps to various sounds one by one.

**6.2.5.3 E2Amt = Envelope 2 Amount < 000-127 >**

For a simple pitch envelope that changes the pitch over time. This parameter controls the amount of this software-driven pitch envelope for F-OSC 2.

## 6.2.6 MB Page 4 A

M	L1Wav	L1Rat	L1Int	Vol
B	001	010	005	127

### 6.2.6.1 L1Wav = LFO 1 Wave < 000-063 >

Selects the LFO 1 (Low Frequency Oscillator) Waveform. The LFO 1 is used to modulate the tuning of F-OSC 1. See Kick Drum LFO Wave description for more information on the waveforms. These descriptions apply to all LFOs in the Alpha Base.

### 6.2.6.2 L1Rat = LFO 1 Rate < 000-127 >

LFO Rate controls the speed of LFO 1.

### 6.2.6.3 L1Int = LFO 1 Intensity < 000-127 >

LFO 1 Intensity controls the amount of pitch modulation of F-OSC 1. Zero turns the modulation off.

### 6.2.6.4 Vol = Volume < 000-127 >

Controls the volume of the instrument.

**6.2.7 MB Page 4 B**

M	L2Wav	L2Rat	L2Int	Acc
B	001	010	005	127

**6.2.7.1 L2Wav = LFO 2 Wave < 000-063 >**

Selects the LFO 2 (Low Frequency Oscillator) Waveform. The LFO 2 is used to modulate the pitch of F-OSC 2. See Kick Drum LFO Wave description for more information on the waveforms. These descriptions apply to all LFOs in the Alpha Base.

**6.2.7.2 L2Rat = LFO 2 Rate < 000-127 >**

LFO 2 Rate controls the speed of LFO 2.

**6.2.7.3 L2Int = LFO 2 Intensity < 000-127 >**

LFO 2 Intensity controls the amount of pitch modulation of F-OSC 2. Zero turns the modulation off.

**6.2.7.4 Acc = Accent < 000-127 >**

Accent determines how hard the instrument is played when an ACC is set in the sequencer. The maximum accent level also depends on the volume of the instrument. The volume defines the absolute maximum level that is played if accent is set to <127>, whereas lower accents adjust the dynamics in the range between the two values (no ACC = volume/2) and (ACC = volume/2 + accent).

## 7 Sample Based Instruments

While Kick Drum and MBrane are generated by pure analog circuitries, the succeeding six instruments are built hybridly and consist of mono samples that are run through real analog filters and VCAs. Each analog sample channel is an independent voice with its filter and VCA and has its own metallic noise that alternatively can be used as a signal source or be mixed to the sample.

With metallic noise only, it becomes a pure analog instrument again. Four channels make use of a multimode filter that is capable of resonance - again they can be used as true analog instruments with the self-oscillating filter as only sound source if you wish.

For the sake of simplicity, the six analog sample channels are described together. The HiHat channels and the multimode filter channels differ only in a few filter parameters.

### 7.1 Sample Engine

#### 7.1.1 SMP Page 1 A (every sampling instrument including X Sample tracks)

C	Pitch	Start	Stop	Samp
H	055	000	063	127

##### 7.1.1.1 Pitch < 000-127 >

Controls the pitch of the sample in semitones. A Pitch value of <055> is the nominal playback pitch of the loaded sample. A very wide range of pitch transposition is possible.

##### 7.1.1.2 Start < 000-127 >

Defines the start point of the sample. The normal flash memory sample has a length of 64k samples or about 1.35 sec at nominal pitch <055>. The start point value finds the closest zero crossing in a window of +/- 256 samples.

##### 7.1.1.3 Stop < 000-127 >

Defines the stop point of the sample. The normal flash memory sample has a length of 64k samples or about 1.35 sec at nominal pitch <055>. The stop point value finds the closest zero crossing in a window of +/- 256 samples.

**7.1.1.4 Sample < 000-300 >**

Selects the sample from the sample flash memory. The flash memory is divided into 300 equally-length sample slots. Each slot has a length of 64k (= 65536) samples or about 1.35 sec at nominal pitch <055>. Every sample based instrument accesses the same pool of 300 samples. But as the sample can be bent extremely soundwise, two channels may access the same sample but can sound very different as a result.

How to upload your own samples from SD card is described in section DISK.

If Sample = <000>, <off> is displayed, the sample playback is muted and only the analog part of the signal chain can be heard.

**7.1.2 SMP Page 1 B (every sampling instrument including X Sample tracks)**

C	Cents	Loop	LopOn	Revr
H	000	000	000	128

**7.1.2.1 Cents < 000-127 >**

Controls the tuning of the sample in cents. One cent is a 1/100 of a semitone interval (Pitch on Page A). A cent value of <000> is the nominal playback pitch. A cent value of <050> is a quarter tone between two adjacent semitones (Pitch and Pitch+1). A value higher than <100> reaches into the next semitone of the actually selected semitone (Pitch+1).

**7.1.2.2 Loop < 000-127 >**

Defines the loop point of the sample. The normal flash memory sample has a length of 64k samples or about 1.35 sec at nominal pitch <055>. The loop point value finds the closest zero crossing in a window of +/- 256 samples.

**7.1.2.3 LopOn = Loop On < 000/128 >**

Sets loop mode on or off. In loop mode, the sample playback starts with the start point, runs to the stop point and loops back to the loop point until it reaches the stop point again and so forth.

**7.1.2.4 Revr = Reverse play < 000/128 >**

In reverse mode, the sample playback starts with the stop point and plays in reverse to the start point.

## 7.2 Sample Analog Engine

After the sample there is an analog VCA (Voltage Controlled Amplifier) envelope, which produces an analog loudness curvature of the digital sample. Furthermore, you can insert a filter into the signal path between the sample output and the final VCA. See the block diagram of one sample based analog voice below. Note that the structure is the same for all voices, but the two HH channels have a 6dB LP/HP filter optimized for Hi Hats and the other four channels a 12dB resonating multimode filter with LP, HP and BP.

If the sample playback is muted (sample = <off>), you can only hear the analog signals like metal noise run through the filter or the filter resonance whistling. That requires routing to be > 0 because with routing = <000> the analog filter and metal noise are turned off and only the sample runs through the final VCA.

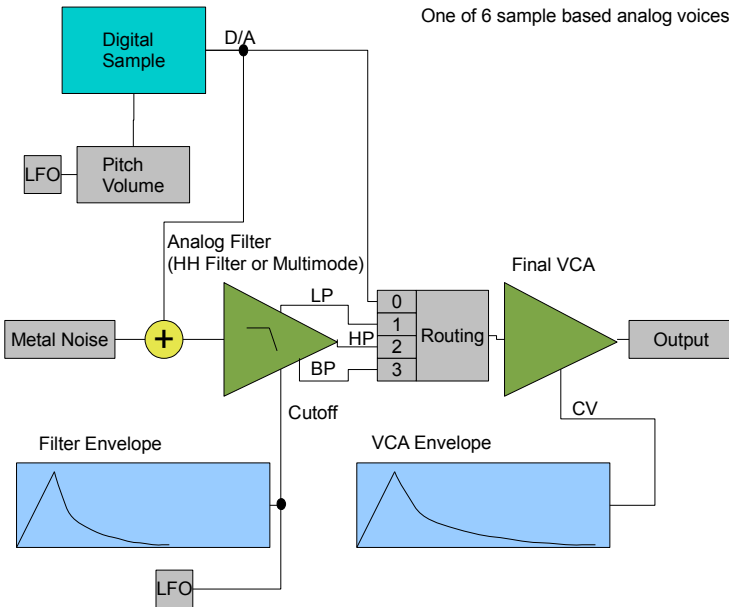

### 7.2.1 SMP Page 2 A

```

C VCAAtt VCDec VCSus VRel
H 055    000    063    127

```

#### 7.2.1.1 VCAAtt = VCA Attack < 000-127 >

Controls the attack of the VCA envelope. The VCA envelope is made for percussive and punchy sounds. So the lower area can modulate the attack in a very precise way.

#### 7.2.1.2 VCDec = VCA Decay < 000-127 >

Controls the decay of the VCA envelope.

#### 7.2.1.3 VCSus = VCA Sustain < 000-127 >

Controls the sustain of the VCA envelope. This is the value to which the envelope rises or falls after attack and decay have faded when the key is held. Please note that the VCA envelope may cut the length of the sample significantly, so if you are not sure how long the sample should sound, turn up sustain to make sure the VCA envelope is open.

#### 7.2.1.4 VCRel = VCA Release < 000-127 >

Controls the release of the VCA envelope. This is the value of how fast the envelope falls from the sustain level to zero after the key has been released.

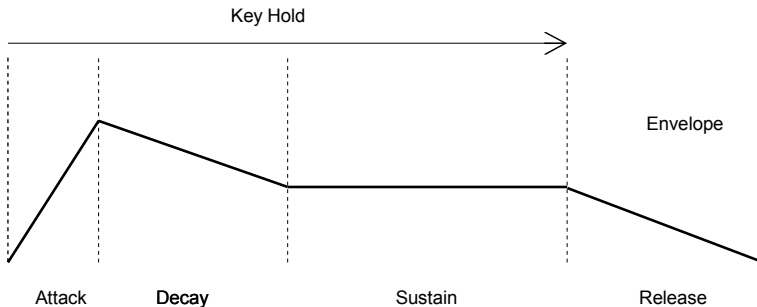

**7.2.2 SMP Page 2 B**

C	FiAtt	FiDec	FiSus	FRel
H	055	000	063	127

**7.2.2.1 FiAtt = Filter Attack < 000-127 >**

Controls the attack of the filter envelope. The filter envelope controls the cutoff of the filter and creates a sound curvature. Please note that you can only hear filtering if the routing is > 0 because otherwise the filter is off the signal chain.

**7.2.2.2 FiDec = Filter Decay < 000-127 >**

Controls the decay of the filter envelope.

**7.2.2.3 FiSus = Filter Sustain < 000-127 >**

Controls the sustain of the filter envelope. This is the value to which the envelope rises or falls after attack and decay have faded when the key is held.

**7.2.2.4 FiRel = Filter Release < 000-127 >**

Controls the release of the filter envelope. This is the value of how fast the envelope falls from the sustain level to zero after the key has been released.

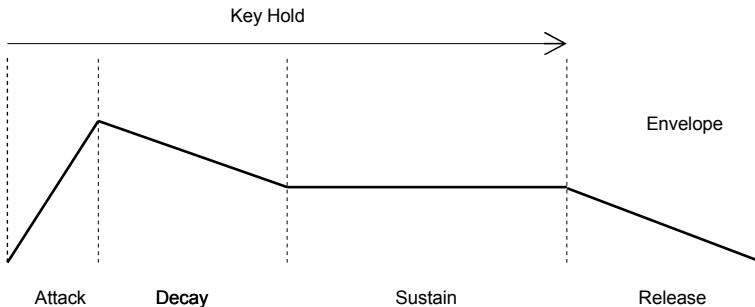



### 7.2.3 CH/OH Page 3 A (only Hi Hat Filter)

This page only describes the Hi Hat filter section and applies to the two instruments Closed Hi Hat and Open Hi Hat. It's different from the other four channels with multimode filter (Clap, Rim, Crash and Ride). Two 6dB filters form a band pass that has peak. Tweak both part filters to get your desired result.

If LpCut = <127> and HpCut = <000>, the filter has its largest bandwidth. This filter, however, is optimized for Hi Hat sounds and has therefore a limited bandwidth that cuts well below 250hz even with maximum adjustments. In order to have a flat frequency response on a Hi Hat channel, turn off the filter with Routing = <000>.

C	LpCut	HpCut	Res	Rout
H	055	000	063	001

#### 7.2.3.1 LpCut = Low Pass Cutoff < 000-127 >

Controls the cutoff of the 6dB low pass filter of the HiHat filter. With a value of <127> the low pass filter is opened to the maximum. At lower values higher frequencies are filtered away (duller).

#### 7.2.3.2 HpCut = High Pass Cutoff < 000-127 >

Controls the cutoff of the 6dB high pass filter of the HiHat filter.

#### 7.2.3.3 Res = Resonance < 000-127 >

This parameter controls the resonance of the resulting band pass filter. <000> means that the filter doesn't have resonance. Even at maximum peak the filter will not resonate but only become nosy.

#### 7.2.3.4 Rout = Filter Routing < 000-001 >

The filter routing switches between pure sample playback and filtered playback.

Routing = <000>: No filter, no metal noise.

Only sample playback through the analog final VCA.

Routing = <001>: With Hi Hat filter, optional metal noise.

The sample is mixed to metal noise (if activated), led through the filter and played back through the analog final VCA.

**7.2.4 CH/OH Page 3 B (only Hi Hat Filter)**

C	LpCut	HpCut	EvAmt	MtNz
H	055	000	063	001

**7.2.4.1 LpCut = Low Pass Cutoff < 000-127 >**

Same as Page A.

**7.2.4.2 HpCut = High Pass Cutoff < 000-127 >**

Same as Page A.

**7.2.4.3 EvAmt = Envelope Amount < 000-127 >**

This parameter controls the envelope amount. The envelope creates a cutoff modulation over time. The amount determines how strongly the envelope bends the filter cutoff.

**7.2.4.4 NtNz = Metal Noise < 000-127 >**

The parameter changes the noise to a metallic noise which consists of periodic asynchronous bit patterns.

With <000> the noise generator is turned off, <001> yields a static random noise (white noise). On values above that <2-127>, a complex signal formed from digital multitones and bit patterns is produced. Each value represents a unique sound pattern which doesn't change smoothly across the range but jumps to various sounds one by one, more akin to a kaleidoscope than a linear scale. They give you interesting results for any adjustment, so play the game of trial and error!

Metallic Noise yields a rather aperiodic signal which results in noise-like sounds but with tone-like structures within.

### 7.2.5 SMP Page 3 A (only MM Filter Instruments Clap, Rim, Crash and Ride)

This page only describes the multimode filter section and applies to the four instruments Clap, Rim, Crash and Ride. A 12dB analog multimode filter capable of full resonance has three outputs: low pass, high pass and band pass. The router (see block diagram 46) selects the signal that is led through the final VCA. As the multimode filter works precisely and covers the whole audio range from 10Hz – 20kHz, it can be used as oscillator sound source as well if it is in full resonance mode.

C	Cutoff	Res	EvAmt	Rout
P	055	000	063	001

#### 7.2.5.1 Cutoff < 000-127 >

Controls the cutoff frequency of the filter. Depending on the kind of filter (see Routing), the frequencies of the input spectrum are cut above (LP), below (HP) or besides (BP) the cutoff frequency. The resonance also affects the slope (steepness) of the filter. If the filter is in self-resonating mode, the cutoff frequency controls the pitch of the whistling tone.

#### 7.2.5.2 Res = Resonance < 000-127 >

Controls the resonance. Above about <085>, the filter starts to oscillate and creates a whistling tone. If no sample or metal noise is applied, the resonating filter can be used as oscillator sound source in order to create stick, conga or tom tom like tones.

#### 7.2.5.3 EvAmt = Envelope Amount < 000-127 >

This parameter controls the envelope amount. The envelope creates a cutoff modulation over time. The amount determines how strongly the envelope bends the filter cutoff.

**7.2.5.4 Rout = Filter Routing < 000-003 >**

The filter routing switches between pure sample playback and filtered playback.  
 Routing = <000>: No filter, no metal noise. Only sample playback through the analog final VCA.

Routing = <001>: Low Pass + metal noise. The sample is mixed to metal noise (if activated), led through the filter and played back through the analog final VCA.

Routing = <002>: high pass + metal noise.

Routing = <003>: band pass + metal noise.

**7.2.6 SMP Page 3 B (only MM Filter Instruments Clap, Rim, Crash and Ride)**

C	Cutoff	Res	EvAmt	MtNz
P	055	000	063	001

**7.2.6.1 Cutoff < 000-127 >**

Same as Page A.

**7.2.6.2 Res = Resonance < 000-127 >**

Same as Page A.

**7.2.6.3 EvAmt = Envelope Amount < 000-127 >**

Same as Page A.

**7.2.6.4 NtNz = Metal Noise < 000-127 >**

The parameter changes the noise to a metallic noise which consists of periodic asynchronous bit patterns.

With <000> the noise generator is turned off, <001> yields a static random noise (white noise). On values above that <2-127>, a complex signal formed from digital multitones and bit patterns is produced. Each value represents a unique sound pattern which doesn't smoothly change across the range but jumps to various sounds one by one. Metallic Noise yields a rather aperiodic signal which results in noise-like sounds but with tone-like structures within.

**7.2.7 SMP Page 4 A (every sampling instrument including X Sample tracks)**

C	LFWav	LFRat	LFTun	Vol
H	001	010	005	.127

**7.2.7.1 LFWav = LFO Wave < 000-063 >**

Selects the LFO (Low Frequency Oscillator) Waveform. Each sample channel has its own LFO which is used to modulate different parameters. See Kick Drum LFO Wave description for more information on the waveforms. These descriptions apply to all LFOs in the Alpha Base.

**7.2.7.2 LFRat = LFO Rate < 000-127 >**

LFO Rate controls the speed of the sample channel LFO.

**7.2.7.3 LFTun = LFO Sample Tune Amount < 000-127 >**

LFO tune amount controls the amount of tune modulation of the sample. Zero turns the modulation off.

**7.2.7.4 Vol = Volume < 000-127 >**

Controls the volume of the instrument.

**7.2.8 SMP Page 4 B (every sampling instrument including X Sample tracks)**

C	LFsyn	LFVCA	LFcut	Acc
H	000	010	005	127

**7.2.8.1 LFsyn = LFO Synchronization < 000/128 >**

If LFO sync is on <128>, the LFO phase restarts with every note trigger. For this reason, most LFO waveforms have a positive or negative version stored (For example +sine and -sine). If the LFO waveform restarts with the trigger it makes a huge difference if the signal sweeps negatively or positively first.

If off, the LFO runs free and you can, for instance, slowly modulate the cutoff frequency and create up- and down waves on the filter independently from the notes played.

**7.2.8.2 LFVCA = LFO VCA Amount < 000-127 >**

The LFO can modulate the loudness of the sample. This is also called tremolo if the LFO speed is in a certain range. Please note that only the sample gets modulated, not the analog VCA envelope. Therefore you can only hear the effect if the sample is in the signal chain and the envelope is open (key is held). If this parameter is at maximum <127>, the LFO waveform closes and opens the sample volume at 100%. With <000> there is no modulation and the sample has full volume. Any value in between will only partly open and close the sample volume.

**7.2.8.3 LFcut = LFO Cutoff Amount < 000-127 >**

LFO cutoff amount can modulate the filter cutoff with the LFO. You can only hear the effect if the filter activated in the filter routing is  $\geq 1$ . If the resonance is high, you can create a sweeping tone with the filter

**7.2.8.4 Acc = Accent < 000-127 >**

Accent determines how hard the instrument is played when an ACC is set in the sequencer. The maximum accent level also depends on the volume of the instrument. The volume defines the absolute maximum level that is played if accent is set to <127>, whereas lower accents adjust the dynamics in the range between the two values (no ACC = volume/2) and (ACC = volume/2 + accent).

## 7.3 X Sample Instruments

Basically the two X Sample instruments have the same sampling engine as the hybrid analog sample channels, except the analog functions like envelopes, filters and metal noise are missing and the instruments are only played back on the stereo mix output. They have no individual output.

Sampling of external audio signals is only possible on these two instruments.

For the sake of simplicity, the following paragraphs describe only the parameters that differ from the hybrid analog sample channels. The rest is described in section 7.1-7.2

### 7.3.1 X1/X2 Page 1 A

X	Pitch	Start	Stop	Samp
1	055	000	127	RAM1

#### 7.3.1.1 Sample select X < RAM1, RAM2, 2-300 >

Selects the sample from the sample flash memory. The difference to the hybrid analog sample channels is that the 2 low positions (RAM1, RAM2) play back from the RAM sample buffer. It may contain a previously loaded sample either from disk or by the internal sampling function.

RAM1 means that the whole sampling RAM of 256k (= 262144) samples is played back. This is 4 times the regular flash memory slots of 64k samples and has an endurance of 5.46 sec at nominal pitch ( Pitch = <055> ). At 120 BPM this is more than 2 measures, so it's even usable for drumloops.

Please note that if both X instruments have RAM1 selected, the other X sample instrument plays back exactly the same buffer.

If RAM2 is selected, the first instrument X SAMPLE 1 addresses the lower half of the RAM sample buffer, X SAMPLE 2 the upper half.

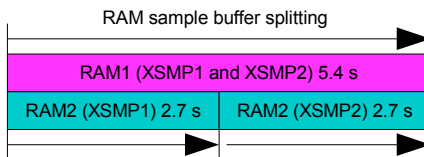

This also implies that, for instance, X1 may be set to RAM1 and plays the RAM buffer at full length, while X2 is set to RAM2 and starts at the second half of the RAM buffer.

### 7.3.2 Recording a Sample

Recording of a sample is only possible on the X sample instruments.

- Connect an audio source to one of the inputs. The left input records by default to X Sample 1 and the right input to X Sample 2.
- Prepare your X Sample instrument by selecting sample select to either RAM1 or RAM2. Set the pitch to <055>, start to <000> and stop to <127>. Set the volume and accent to <127>.
- Press the X-REC button. If you are in Kit select mode, the audio input is monitored by two bars on the right side of the display.



- Use the input gain knob to level the audio input. You can hear the external audio input on the stereo mix output. Make sure it is not distorted. You can even use a guitar without preamp as the input is Hi-Z.
- Press **(EDIT/TRIG)** to enter edit mode (LED=on), select the X Sample track and set a step in the X Sample track. It is useful to set only one step with accent on the second quarter beat (i.e. step 5). If your audio source is synchronized with the Alpha Base, you might also set step 1. (Of course you can set as many steps as you want but if you activate recording it will record the sample on any step that is played next).
- While you are still in edit mode, double click on the instrument key of the X Sample instrument and the instrument key LED starts to blink. Now the sampling input is activated.
- If you start the sequencer and the sequencer spot comes across the set step, the recording starts, indicated by the blinking instrument key LED going dark.
- The sample is now recorded into the RAM buffer, depending on your sample select settings described above. If it is RAM1, the whole RAM buffer gets recorded. If it is RAM2, only the assigned half of the RAM buffer gets recorded, i.e. lower half on X Sample 1 and upper half on X Sample 2.
- If you trigger the instrument key (edit mode off) you should hear your recording. Set your sample to whatever step you like and change tuning or modulation.



### 7.3.3 Manually Recording a Sample

- There is also a way of manually triggering the recording:  
Press **(EDIT/TRIG)** (LED=on), select X Sample 1 or 2 and double click on the instrument key without setting a step in the track. Sample recording is activated, indicated by a blinking instrument LED.
- Press again **(EDIT/TRIG)** and leave the edit mode (LED=off).
- As soon as you press the instrument key, the instrument channel starts recording and the instrument LED goes dark.
- After the recording has been finished, you can play it back by triggering again.

Storing a successfully recorded RAM sample buffer is described in section DISK.

## 7.4 FM Synth

The FM Synth is a little 4 operators 6-voice digital synth dedicated to percussive sounds. A versatile FM modulation matrix lets you create almost any of the known FM algorithms as the 4x4 matrix offers every possible forward and feedback modulation.

### 7.4.1 FM Synth modulation matrix

If you select the FM synth track on page A, the 4x4 knob matrix resembles the following scheme:

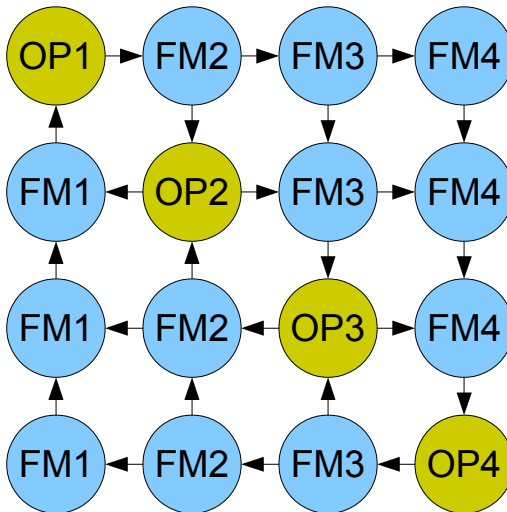

Each knob of the green diagonal is one operator and the knobs OP1-OP4 control the base frequency of that operator.

The knobs in the upper half of the matrix control the amount of FM modulation according to the direction of arrows. The horizontal arrows indicate the direction of output of the operators. The vertical arrows indicate the direction of modulation (FM1-FM4). The index of the FM modulation describes the destination of that column (for instance, all FM4 modulate OP4). That means the upper half is the forward modulation. OP1 modulates OP2, OP3 or OP4 according to the amounts set by the blue FM knobs in the first row. OP2 can modulate OP3 or OP4 in the second row and so forth.

The lower part of the matrix is the feedback modulation, indicated by the arrows going

to the left or upwards. If you are editing FM sounds, beware that the feedback can cause unpredictable results as this is a bit like chaos theory, so just add small amounts of lefthanded feedback FM controls if you have already set strong righthanded modulations. (Of course, like many things in math, this is a symmetrical matrix, so if you only use the lefthanded modulations, the righthanded act as feedback. But in order to not confuse everybody, we say the righthanded are the forward-moving and the lefthanded are the feedback modulations as we read and write from the left to the right).

Mostly you would want to create a sound like the following: OP 1 is the base tone and has the lowest frequency, the other OP2- OP4 have ascending frequencies in order to create more and more overtones. Now modulate the higher OPs by the lower and you obtain wonderful, typical FM sounds. Then add a little feedback on the lefthanded controls and hear the chaos rise...

The display always shows one row of the matrix if a knob is turned:

#### 7.4.1.1 FM Modulation Matrix Page A

The numbers of the FM amounts show the source and destination of the matrix FM amounts as described above. The following pages show the other parts of the matrix:

F	S1Frq	FM1-2	FM1-3	F1-4
M	016	010	.055	029

F	FM2-1	S2Frq	FM2-3	F2-4
M	000	029	.005	007

F	FM3-1	FM3-2	S3Frq	F3-4
M	000	000	.068	007

F	FM4-1	FM4-2	FM4-3	S4Fr
M	000	000	.000	095

## 7.4.2 FM Synth Operator Description

One of the 4 operators looks like this:

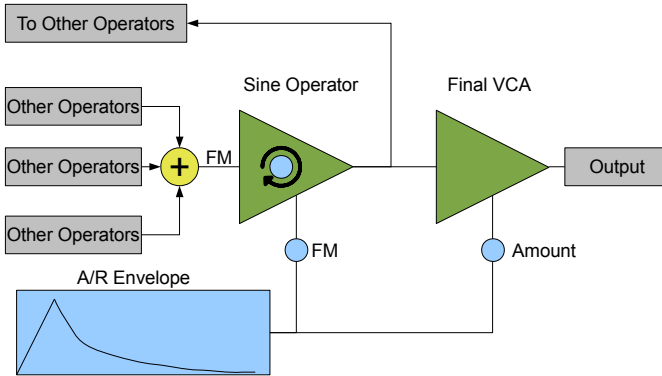

A sine operator is modulated by the outputs of the other 3 sine operators and can feedback its own output to the other FM operators. A simple Attack/Release envelope generator can FM-modulate the sine operator as well.

The modulated operator signal is then masked by a final VCA which is controlled by the A/R envelope generator. The amount determines the volume of this particular operator. The outputs of the 4 operators are then mixed together and produce the sound of one voice.

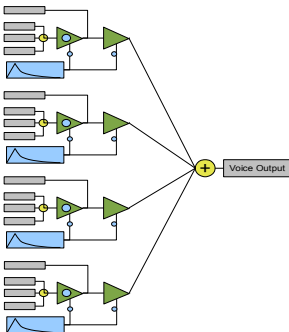

Up to 6 voices can be played. The 6 voices can be addressed by an external midi keyboard which plays them polyphonically. The chord is stored in the preset and is played as a fixed chord by the internal sequencer according to the maximum number of voices. This chord is shifted in whole by the sequence play function SEQ.

See 2<sup>nd</sup> functions 12.9 stereo panning section for some hidden FM synth settings.

### 7.4.3 FM Synth Envelope Page B

If you switch to page B in the FM Synth, the following screen is shown:

```
F EG1At EG1RI S1Amt S1FM
M 000 100 .127 000
```

Every row page corresponds to one sine operator 1-4. As all 4 pages are the same, only page 1 for sine operator 1 is listed here. The other pages yield the same for sine operators 2-4.

#### 7.4.3.1 EG1At = Sine Operator 1 Envelope Generator Attack <0-127>

This parameter controls the attack time of above described A/R envelope. Every Operator has its own A/R envelope.

#### 7.4.3.2 EG1RI = Sine Operator 1 Envelope Generator Release <0-127>

This parameter controls the release time of the above described A/R envelope.

#### 7.4.3.3 S1Amt = Sine Operator EG1 VCA Amount <0-127>

This parameter controls the amount of the A/R envelope generator 1 to the VCA. This also controls the volume of the specific operator. The envelope masks the sine operator, and with an amount of <000> the operator is turned off in the mix of the voice output.

#### 7.4.3.4 S1FM = Sine Operator EG1 FM Amount <0-127>

This parameter controls the FM amount of the A/R envelope generator 1 to sine operator 1. The envelope modulates the frequency of the sine operator. This is useful for decaying tomtom-like sounds.

## 7.5 Effects

There are two on-board effects available: reverb and delay. Actually the fx section is part of parameter sets of the single kit and stored along with the preset. It is handled like an instrument page.

The fx are send effects. Every analog instrument has its own A/D converter for this purpose. Exceptions are Kick Drum and MBrane who share the A/D converter with the sampling inputs and the stereo mix out via an input selector switch.

The true analog signal from the instrument's output is picked up, A/D converted and sent to the FX input.

The fx send amount controls the FX intensity of the instrument. For professional studio applications, there is a reverb kill switch that mutes all digital effects with one click – Knob 14 click mutes or unmutes all FX.

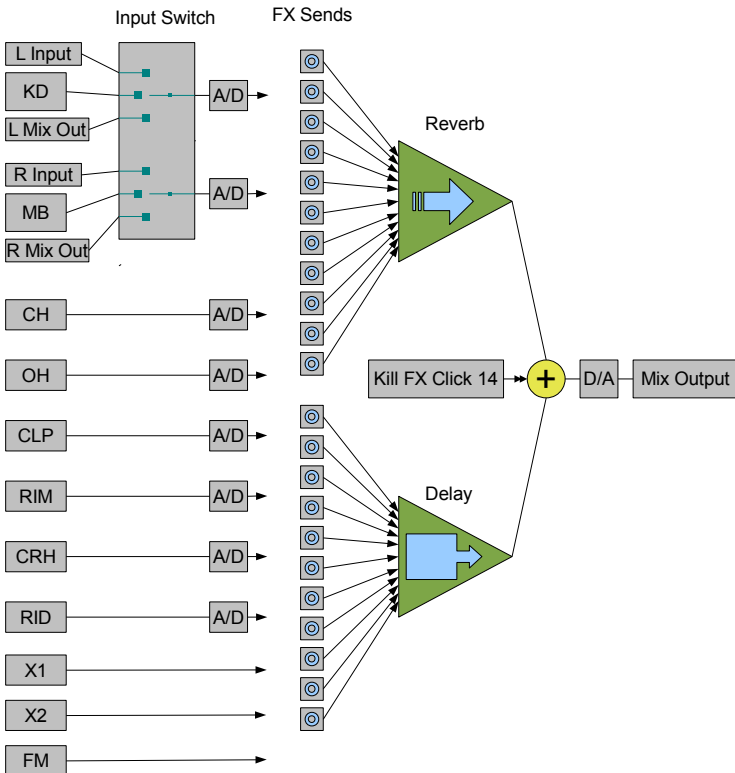

### 7.5.1 Entering the FX page

Press **(Shift)** - all 16 step LEDs start to blink - and then select **(Step)** 12 = FX. The display shows:

```
Effects Program
Press enter
```

Now press **(Enter)** and, depending on the current page selected, the Reverb or the Delay section opens.

### 7.5.2 Reverb Parameters Page 1 A

```
R RomSz LoFrq HiFrq RevL
V 077 100 .005 063
```

#### 7.5.2.1 Reverb Room Size

The room size is basically a feedback of the reverb algorithm, defining the amount of reflections that return to the reflection delay lines and are not diffused. The larger a room is, the longer the reflections maintain their trajectory and the longer the reverberation decays.

Because on the Alpha Base the reverb is more thought to be a creative effect rather than a completely natural room simulation, room size can go up to rather extreme values, so be careful above <100>, it can go to an almost endless reverb and even start to oscillate by feedback. It depends a lot on the filtering (see next stages), whether the room size above <100> leads to a "resonance catastrophe", meaning distortion by feedback.

#### 7.5.2.2 Reverb Low Frequencies

Low frequencies are cut out on reflections, <127> = off. The lower the value, the duller the reverb gets. As we used a 2-pole filter, you can create interesting effects if you play with both filter cutoffs. Again, this is more a creative effect rather than a perfect reverb.

#### 7.5.2.3 Reverb High Frequencies

High frequencies are cut out on reflections, <000> = off. The higher the value, the thinner the reverb gets. In conjunction with the low pass filter you can achieve quite extreme bandpass settings. If both filters have about the same value, it results in an endless peak filtering that easily can distort if room size is bigger than <100>.

#### 7.5.2.4 Reverb Level

Controls the general reverb output level on the mix output.

#### 7.5.3 Reverb Send KD, MB, CH, OH Page 2 A

R	KDrev	MBrev	CHrev	OHrv
V	000	032	000	000

##### 7.5.3.1 Kick Drum Reverb Send

Although reverb on kick drum isn't really used so often, you can adjust it here. For that reason the A/D converters of the kick drum use an input selector and share it with the sampling inputs. Note that you can't process reverb or delay to the kick when X-REC is on, as this switches the A/D to the external inputs.

##### 7.5.3.2 MBrane Reverb Send

The MBrane also shares the A/D converters with the sampling inputs. Note that you can't process reverb or delay to the MBrane analog output when X-REC is on, as this switches the A/D converter input to the external inputs.

##### 7.5.3.3 Closed HiHat Reverb Send

Controls the reverb send of the closed HiHat channel.

##### 7.5.3.4 Open HiHat Reverb Send

Controls the reverb send of the open HiHat channel.



## 7.5.4 Reverb Send CLAP, RIM, CRASH, RIDE Page 3 A

R	CPrev	RMrev	CRrev	RDrv
V	056	032	025	031

### 7.5.4.1 Clap Reverb Send

Controls the reverb send of the Clap channel.

### 7.5.4.2 Rim Reverb Send

Controls the reverb send of the Rim channel.

### 7.5.4.3 Crash Reverb Send

Controls the reverb send of the Crash channel.

### 7.5.4.4 Ride Reverb Send

Controls the reverb send of the Ride channel.

### 7.5.5 Reverb Send X1, X2, FM, Rev on/off Page 4 A

R	X1rev	X2rev	FMrev	Revb
V	056	032	025	on

#### 7.5.5.1 X Sample 1 Reverb Send

Controls the reverb send of the X Sample 1 channel.

#### 7.5.5.2 X Sample 2 Reverb Send

Controls the reverb send of the X Sample 2 channel.

#### 7.5.5.3 FM Synth Reverb Send

Controls the reverb send of the FM Synth channel.

#### 7.5.5.4 Reverb on/off

Switches the whole reverb processor on or off. This works only for the reverb, not the delay section.

## 7.5.6 Delay Parameters Page 1 B

On page B you can find the delay parameters:

D	DTime	Feedb	Spat1	DeLL
L	064	100	.098	127

### 7.5.6.1 Delay Time

The input signal is just delayed to the output and this parameter controls the time of the delay.

### 7.5.6.2 Delay Feedback

A part of the output signal is fed back to the input of the delay line, causing to repeat the delayed signal to an echo.

### 7.5.6.3 Delay Spatial

The delayed output signal is flipped from one stereo side to the other each time after the delay line has run out and wraps back. You can create interesting stereo ping pong delays with this function. Spatial = <000> just puts the delay to the centre of the stereo image, while Spatial = <127> spreads the stereo image at maximum.

### 7.5.6.4 Delay Level

Controls the general delay output level on the mix output.

### 7.5.7 Delay Send KD, MB, CH, OH Page 2 B

D	KDdel	MBdel	CHdel	OHd1
L	000	032	000	000

#### 7.5.7.1 Kick Drum Delay Send

Controls the delay send on the kick drum. The A/D converters of the kick drum use an input selector and share it with the sampling inputs. Note that you can't process reverb or delay to the kick when X-REC is on as this switches the A/D to the external inputs.

#### 7.5.7.2 MBrane Delay Send

The MBrane also shares the A/D converters with the sampling inputs. Note that you can't process reverb or delay to the MBrane analog output when X-REC is on as this switches the A/D converter input to the external inputs.

#### 7.5.7.3 Closed HiHat Delay Send

Controls the delay send of the closed HiHat channel.

#### 7.5.7.4 Open HiHat Delay Send

Controls the delay send of the open HiHat channel.

### 7.5.8 Delay Send CLAP, RIM, CRASH, RIDE Page 3 B

D	CPdel	RMdel	CRdel	RDd1
L	000	032	000	000

#### 7.5.8.1 Clap Delay Send

Controls the delay send of the Clap channel.

#### 7.5.8.2 Rim Delay Send

Controls the delay send of the Rim channel.

#### 7.5.8.3 Crash Delay Send

Controls the delay send of the Crash channel.

#### 7.5.8.4 Ride Delay Send

Controls the delay send of the Ride channel.

### 7.5.9 Delay Send X1, X2, FM, Rev on/off Page 4 A

D	X1del	X2del	FMdel	Delay
L	056	032	025	on

#### 7.5.9.1 X Sample 1 Delay Send

Controls the reverb send of the X Sample 1 channel.

#### 7.5.9.2 X Sample 2 Delay Send

Controls the reverb send of the X Sample 2 channel.

#### 7.5.9.3 FM Synth Delay Send

Controls the reverb send of the FM Synth channel.

#### 7.5.9.4 Delay on/off

Switches the whole delay processor on or off. This works only for the delay, not the reverb section.

## 8 Single/Multi Mode

The Alpha Base has two memory models: Single Mode and Multi Mode. The following picture shows in a simplified graphic example that the Single Kits have a linear memory order and the Multi Sets a vectorized order:

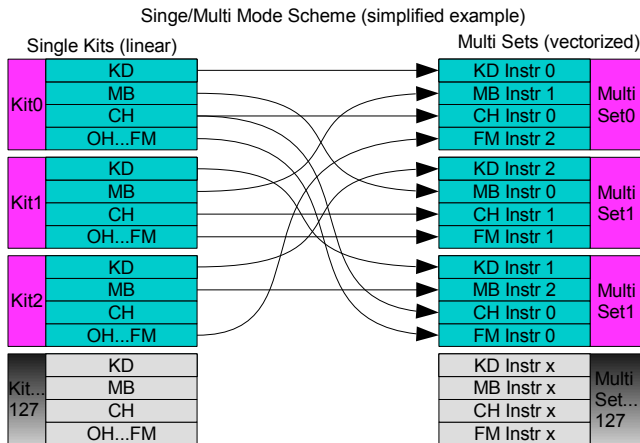

The Single Kits are 128 ascending memory locations containing all the data for the sounds of all 11 instruments and the FX.

In fact, the Multi Sets are nothing but pointers (vectors) to an instrument out of 128 Single Kits. Every Multi Mode Kit is a combination of 11 instrument pointer numbers that can each be taken from any Single Kit you desire.

So if you play an instrument in Multi Mode, the actual data buffer is read from the Single Kit's instrument the instrument number points to.

The great advantage of the Multi Mode is that you can select instruments of your choice from a pool of different kits and switch between your favourite sounds in a setup when you are looking for sounds. Maybe you like the kick drum of kit 1 most but want to find a clap sound or snare drum that fits best to that kick drum in your desired track and it's the clap from kit 23.

In either modes, editing and sequencing is possible. In single mode you store the edited parameters into the very memory location you currently are (e.g. kit 022). In Multi Mode, the sound edits are stored into the specific instruments of the kits the Multi Set points to, plus the selection of instruments of the Multi Set itself.

## 8.1 Activating Single or Multi mode

Press **(Shift/Cancel)** and then **(Step 14)** to switch between Single Mode and Multi Mode. The display shows:

```
Mode Select
Single Mode_
```

Turn the **(Data)** wheel to choose the desired mode and then press **(Enter)**. The display shows one of the the following modes:

### Single Mode:

	Kit No	BPM
AlphaOne	000	120.0
		
Volume:	KD MB CH OH CP RM CR RD X1 X2 FM	

This is the linear memory model and selecting a kit is made via **(Data)** wheel or the **(Up/Down)** buttons, and the loading with **(Enter)**. Every Kit preset location contains a list of parameters for every 11 instruments + FX that are loaded upon entering.

### Multi Mode:

Kit No	KD	MB	CH	OH	CLP
MultiK000	07	01	14	11	08
07	09	04	06	05	24
	11	23			
	RIM	CRH	RID	X1	X2
	FM	REV	DEL/PAN		

The 3-digit number right to the name ("MultiK") is the number of the 128 possible Multi Sets. The numbers right of that represent the 13 instrument pointer numbers including effects in ascending order, i.e. KD, MB, CH, OH, CLP, RIM, CRH, RID, X1, X2, FM, REV, DEL/PAN.

If the cursor is at the upper leftmost position, selecting one of 128 possible Multi Kits is made via **(Data)** wheel or the **(Up/Down)** buttons and loaded with **(Enter)**.



### 8.1.1 Selecting an Instrument in Multi Mode

Go right with the cursor to select an instrument track, and you can see the instrument selection LED and the step programming of the track in the step sequencer.

Kit No	KD	MB	CH	OH	CLP
MultiK000	07	01	14	11	08
07	09	04	06	05	24 11 23
RIM	CRH	RID	X1	X2	FM REV DEL/PAN

Use the **(Data)** wheel to select an instrument. You can immediately hear the corresponding instrument taken from the kit number. The rest of the instruments stay as they are. Go on and create a combination of instruments taken from different kits. If you want to temporarily store your Multi Set, press **(Knob 16)** click.

### 8.1.2 Editing and Storing Sounds in Multi Mode

If you have selected an instrument in Multi Mode, you can also switch to parameter mode by pressing **(KIT/SEQ)**. Now you can make the same edits to the instrument parameters as described earlier in Single Mode.

If you want to keep the edits, press **(Knob 16)** click. This quick-stores either the Multi Set and the instrument edits. For long-term storage, use Shift 1 (Store Kit).

Please note that, if you store in Multi Mode, you will change the pointed to instrument in the Single Kit too. But *only* those instrument(s) the Multi Kit points to, not the other instruments in that Single Kit.

Nevertheless, please note that you will change the sound in the pointed to Single Kit too if you edit sounds in Multi Mode.

If you are storing a kit to long-term memory in any mode, the global flags are stored along and are recalled with the next power cycle.

## 9 DISK

### 9.1 File Format

Please use the provided 4GB SD Card or a working SD card with FAT32 file system – not exFAT32 (unsupported due to Microsoft licensing). If you are unsure what file system is used on your SD card, open the properties of the disk drive on your computer (WIN: right-click on drive and select properties) and see which file system is used:

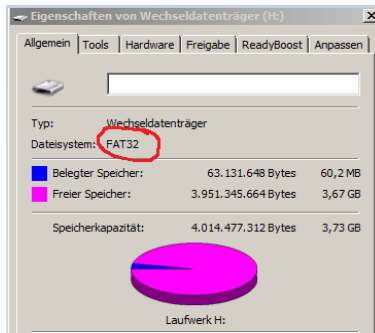

Mostly SD cards smaller than 64GB use the older FAT32 system – but it's not mandatory. The FAT32 file system can comprise up to 8TB disk space but „only“ file sizes of 4GB. Because of the large video file and hi-res picture demands, the exFAT32 was implemented – and not granted - but licensed by Microsoft. It has no real advantage for small applications like the Alpha Base however and is even a little bit slower. Even 4 GB is a LOT of drum samples.

The file format is: \*.WAV 48kHz 16bit mono or \*.RAW 48kHz 16bit mono.

The Alpha Base only stores in RAW format and only in the root directory. But with any modern wave editor you can load these samples and edit them.

For reading samples by the Alpha Base, you can use the root directory or create folders on the SD card that are only one level deep to store your WAV or RAW files in. The Alpha Base can handle up to 30 folders. Don't create subfolders of folders though, as the Alpha Base OS can't read them.

You can only create folders on a computer.

Copy the files to the SD card and insert the SD to the Alpha Base.

## 9.2 Loading Samples from Disk

- Press the **(DISK)** button to enter the disk menu and the display shows the contents of the root directory (if it doesn't do the first time, press **(DISK)** again):

```
WAV found:123 Target001
ABWV0001.raw___Load=Ent
```

- Select the file with the **(Data)** wheel or the **(Up/Down)** buttons – a quick pre-listen function will play the start of the file.

```
WAV found:123 Target001
ABWV0002.raw___Load=Ent
```

### 9.2.1 Change and Open a Folder

- If you want to open a folder on your SD card, go left with the cursor and scroll the folders with the **(Data)** wheel:

```
C:/_____Target001
ABWV0002.raw___Load=Ent
```

```
C:/Drums_1_____Target001
ABWV0002.raw___Load=Ent
```

- Now press and click **(Data)** or **(Enter)**, and the folder opens:

```
C:/Drums_1_____Target001
808CrashL1.wav___Load=Ent
```

- Automatically the cursor jumps to the files in that folder and you can scroll and pre-listen to the files in that folder.

### 9.2.2 Load a Sample into RAM

- Pressing and clicking **(Data)** or **(Enter)** will load that sample into the RAM sample buffer. If one of the X Sample instruments has sample select = <RAM1> or <RAM2>, you can play back the sample on these instruments.

### 9.2.3 Load a Sample into Flash Memory

- Take the cursor right and select Target xxx. That is the flash sample memory slot the file gets copied into. Above 252 there are some free sample slots.

```
C:/Drums_1_____Target255
808CrashL1.wav__Load=Ent
```

- Take the cursor right again and the display changes to "Flash=Ent" .

```
C:/Drums_1_____Target255
808CrashL1.wav__Flash=Ent
```

- Now press and click **(Data)** or **(Enter)** and the machine copies the file into the flash memory.

```
Erasing flash block...
808CrashL1.wav__Flash=Ent
Writing data to flash...
808CrashL1.wav__Flash=Ent
Programming finished
808CrashL1.wav__Flash=Ent
```

- This takes a few seconds and then the file is copied to the internal flash memory. Files bigger than 128k (64kWord) get truncated.
- Then switch to a sample instrument (or better do it before you press DISK), select the same sample select as the target sample and it should play if the envelopes are open (and the filter too if selected with rout > 0).

### 9.3 Save Recording to File

If you go right with the cursor beyond the first page, you come to this page:

```
Save Recording to File
Save=Ent
```

If you press and click **(Data)** or **(Enter)**, you save the RAM buffer of a previous recording to the root directory of the SD card. The Alpha Base automatically creates a file name that is above the highest file name of the file enumeration – which is done when you press DISK or open a folder. The file names are assembled from ABWV\*\*\*\*.raw. The asterisks stand for the file number that is automatically given, e.g. ABWV0124.raw. In order not to overwrite existing files, the index number is incremented on every storing process. As mentioned before, the file format is \*.RAW 48kHz 16 Bit mono. If you want to process this file on a computer, you have to define the sampling rate and bit depth. Almost any wave editor can read this file format.

### 9.4 Load Presets from File

Go right with the cursor and you enter this page:

```
Load Presets from File
ABPR0001.BIN___Load=Ent
```

If there are readable preset files, they are listed in the lower line. Scroll them with the **(Data)** Wheel or the **(Up/Down)** buttons. The Alpha Base can read up to 20 preset files that are indexed like ABPR00\*\*.BIN.

If there is no readable file on the selected index number, the display shows:

```
Load Presets from File
Not found _3__Load=Ent
```

Note that the Alpha Base holds the index number for the next page - Save Presets to File. So if you want to create a new preset file, scroll here for an available index number, shown as Not Found\_X\_\_

But If you want to load a specific preset file, select it and then go right with the cursor.

```
Load Presets from File
ABPR0002.BIN___Load=Ent
```

Now press and click **(Data)** or **(Enter)** and the contents of the preset file is read to the edit buffer RAM.

```
Load Presets from File
Preset file loadedad=Ent
```

One preset file contains all 128 preset kits, 128 multi sets and the global settings. Once you have loaded a preset file, the data is only in the RAM buffer. You can immediately recall and edit the new presets, but keep in mind that after power-off they will disappear unless you store them into flash memory with (shift 1) – or store them altogether as a preset file to the SD card. This might be ideal if you want to extend your preset capacity.

The file structure of the internal data is straightforward binary. You can theoretically process the preset file on a computer and store or archive them.

## 9.5 Save Presets to File

Go right with the cursor and you enter this page:

```
Save Presets to File
Save=Ent
```

If you press and click **(Data)** or **(Enter)**, you save the whole RAM preset buffer as a file to the SD card. Note that the Alpha Base in this OS version can write files only to the root directory. The Alpha Base takes the same index number that was selected in the former page – Load Presets from File. If the file exists, the old is erased first and then the file is written. If not, a new file with the mentioned index number is created, e.g. ABPR0003.BIN.

One preset file contains all 128 preset kits, 128 multi sets and the global settings.

## 9.6 Load Sequence from File

Go right with the cursor and you enter this page:

```
Load Sequence from File
ABSQ0001.BIN___Load=Ent
```

If there are readable sequence files, they are listed in the lower line. Scroll them with the **(Data)** wheel or the **(Up/Down)** buttons. The Alpha Base can read up to 80 sequence files that are indexed like ABSQ00\*\*.BIN.

If there is no readable file on the selected index number, the display shows:

```
Load Sequence from File
Not found _3__Load=Ent
```

Note that the Alpha Base keeps the index number for the next page - Save Sequence to File. So if you want to create a new sequence file, scroll here for an available index number, shown as Not Found\_X\_\_

But If you want to load a specific sequence file, select it and then go right with the cursor.

```
Load Sequence from File
ABSQ0002.BIN____Load=Ent
```

Now press and click **(Data)** or **(Enter)** and the contents of the sequence file is read to the edit buffer RAM.

```
Load Sequence from File
Sequence file loaded=Ent
```

One sequence file contains all 64 patterns - 16 patterns x 4 banks - with all the automation data like pitch sequence and p-locks (not preset/sound data).

Once you have loaded a sequence file, the data is only in the RAM buffer. You can immediately recall and edit the new patterns, but keep in mind that after power-off they will be gone unless you store them into flash memory with (shift 3) - or store them altogether as sequence file to the SD card. This might be welcome if you want to extend your pattern capacity.

The file structure of the internal data is straightforward binary. You can theoretically process the sequence file on a computer and store or archive them.

## 9.7 Save Sequence to File

Go right with the cursor and you enter this page:

```
Save Sequence to File
Save=Ent
```

If you press and click **(Data)** or **(Enter)**, you save the whole RAM pattern buffer as a file to the SD card. Note that the Alpha Base in this OS version can write files only to the root directory. The Alpha Base takes the same index number that was selected in the former page – Load Sequence from File. If the file exists, the old is erased first and

## Version OS 1.2

then the file is written. If not, a new file with the mentioned index number is created, e.g. ABSQ0003.BIN.

One sequence file contains all 64 patterns - 16 patterns x 4 banks - with all the automation data like pitch sequence and p-locks (not preset/sound data).

### 9.8 Load OS System file

Go right with the cursor and you enter this page:

```
Load OS System File
AlphaBas.bin___Load=Ent
```

If in the current directory there is an OS system file called <AlphaBas.bin>, it is shown in the display. You can find this file on the Jomox website:

<http://www.jomox.de/upload/updates/AlphaBas.bin>

You have to download and copy this file to the SD card.

In order to update your Alpha Base with the most recent OS file, press **(Enter)**. The display shows:

```
Attention OS Update!
Are you sure? Load=Ent
```

Now press **(Enter)** again. The updating process starts and the system file gets copied to flash memory. During this process, you MUST NOT turn off the Alpha Base! After a few seconds the display reads:

```
Programming finished
Turn unit off and on
```

Now please turn the Alpha Base off and on again and see the new version number in the display on next booting.

### 9.9 Restore all Flash Samples and Memory

Go right with the cursor and you enter this page:

```
Load all flash samples &
wipe out memory Load=Ent
```



This function requires some preparation and is only intended for restoring the Alpha Base to factory defaults. On the Jomox website you can find a zip folder that contains all factory samples:

<http://www.jomox.de/upload/updates/AlphaBaseWaves.zip>

Download and unzip this file to your computer and store all files to the root directory of your SD card. In this case it must be the root directory. All files are indexed raw files like ABWV\*\*\*\*.raw in ascending order: ABWV0001.raw, ABWV0002.raw, a.s.f. Also there are the files ABPR0000.BIN and ABSQ0000.BIN, which contain the factory presets and patterns.

If you enter this function, the Alpha Base starts to read and copy all found indexed raw files to the corresponding flash sample slots and finally copies the preset and sequence files to permanent flash memory. This takes about 15 minutes. After that, the Alpha Base is in factory condition.

## 9.10 Load Backup File and Restore Presets and Patterns

Go right with the cursor and you enter this page:

```
Load backup file restore  
presets&pattern Load=Ent
```

This function can restore a formerly created backup file in case you have destroyed some of your presets and stored them to flash memory (shift 1, 3), for instance. Press **(Enter)** and if the backup file exists, it copies all its contents to the preset and pattern memories.

As the Alpha Base has a flash-based permanent memory which needs to mute the instruments while the cpu is writing a flash memory block, there is a RAM quick store function for either presets and patterns: Click 15 & Click 16. We recommend using these quick store functions to save your presets and patterns during your work flow. But, similar to a computer, you should not forget to store the RAM to flash memory with (shift 1, 3) before you turn off the machine or all your work will be gone. For this reason, we have added a hidden backup function that shuts down the Alpha Base before you turn off (shift 16). The function copies all RAM contents to the permanent flash memory and then creates a backup file if the SD card drive is present. Only then are you asked to turn off the machine.

## 10 BPM/MIDI

If you press the BPM/MIDI button, you enter the Midi Menu. Here you can find some important parameters for the USB/Midi communication. You can navigate through the various settings with the cursor and change the variables with the **(Data)** Wheel or the **(Up/Down)** buttons.

On the Alpha Base, all Midi channels are firmly assigned to the instruments or global channels. See 13. Appendix for more information.

```

USBhost fail  BPM 120.0
ClkSync off   TxClk off
  
```

The first Midi page shows if the USB port is connected to a host. If you have connected the Alpha Base to a host computer, the display will change to "USBhost connec".

### 10.1 BPM <030-300>

```

USBhost fail  BPM 120.1
ClkSync off   TxClk off
  
```

The first edit after pressing the BPM/Midi button is BPM control. Without navigating through the menus, you can adjust the BPM (Beats Per Minute = Tempo) in tenth of a BPM with the **(Data)** wheel or the **(Up/Down)** buttons.

### 10.2 Midi Settings

#### 10.2.1 ClkSync = Midi Clock Synchronization <on/off>

Go right with the cursor to the ClkSync entry and edit the clock sync with the **(Data)** wheel or the **(Up/Down)** buttons.

```

USBhost fail  BPM 120.0
ClkSync on    TxClk off
  
```

If clock synchronization is activated, the Alpha Base will synchronize to incoming Midi Clock. It makes no difference if the Midi Clock comes from the Midi port or from USB. In order not to create confusing or interfering synchronization, only use Clock via Midi In or USB, not both at the same time. If in sync mode, you can still start and stop the machine internally. If Clock and Midi Start/Stop are incoming, it automatically switches to the sync mode.

### 10.2.2 TxClk = Transmit Midi Clock <on/off>

Go right with the cursor to the TxClk entry and edit the Midi clock transmission with the **(Data)** wheel or the **(Up/Down)** buttons.

```
USBhost fail  BPM 120.0
ClkSync off   TxClk on
```

If clock transmission is activated, the Alpha Base sends out Midi Clock to the Midi Out and the USB midi device (if connected). This is useful if you want to synchronize other hardware synthesizers/sequencers and keep the Alpha Base as a master.

## 10.3 Midi Page 2 Midi Enables

### 10.3.1 TxTrig = Transmit MIDI Note Triggers <on/off>

If this parameter is set to <on>, the Alpha Base sends the Midi notes of the played instruments whether they are from sequencer or manual.

```
TxTrig on  TxCC off
RxTrig on  MidiUSB off
```

If the sequencer is playing, the velocity of the midi notes sent depends on the accent. On normal steps it's 63, with accent steps it's 127.

### 10.3.2 TxCC = Transmit MIDI Continuous Controllers <on/off>

If this parameter is set to <on>, the Alpha Base sends the Midi CC (continuous controllers) of the edit knob that you are currently turning.

```
TxTrig off TxCC on
RxTrig on  MidiUSB off
```

Depending on the instrument selected, the Alpha Base sends the different CCs on different channels. Refer to 13.1 Midi Implementation in the appendix for more information.

### 10.3.3 RxTrig= Receive MIDI Note Triggers <on/off>

If this parameter is set to <on>, the Alpha Base receives Midi notes on channels 1-11 and plays them back on the assigned instruments. In some setups it might be useful to turn this function off because conflicting channels of other instruments cannot be taken away from this Midi port and would cause the Alpha Base instruments to play back unintentionally.

```
TxTrig off TxCC off
RxTrig on MidiUSB off
```

### 10.3.4 USBMidi = USB events to MIDI <on/off>

If this parameter is set to <on>, the Alpha Base forwards the received USB Midi events to the physical Midi port while the received Midi events on the physical Midi port are forwarded to the USB port. The Alpha Base acts as a USB/Midi interface.

```
TxTrig off TxCC off
RxTrig on MidiUSB off
```

## 10.4 Midi Page 3 Sysex Dump Functions

Go right with the cursor to enter the third page of the Midi menu. Here you can find several functions to save kits and sequences via sysex (system exclusive) dump.

```
DumpKit      DumpAllKits
DumpSeq      DumpaAllSeq
```

Select the entry with the cursor buttons and press **(Enter)** to activate the dumping.

### 10.4.1 DumpKit

Sends the contents of the current Single Kit via Midi sysex dump. Set the sysex capable Midi receiver on record and dump the Kit by pressing **(Enter)**.

### 10.4.2 DumpAllKits

Sends the contents of all 128 Single Kits via Midi sysex dump. Set the sysex capable Midi receiver on record and dump the Kits by pressing **(Enter)**. This takes about 5 seconds. The display shows "busy" while sending and "finish" when the dumping has been done.

### 10.4.3 DumpSeq

Sends the contents of the current sequence pattern via Midi sysex dump. Set the sysex capable Midi receiver on record and dump the sequence by pressing **(Enter)**.

### 10.4.4 DumpAllSeq

Sends the contents of the first bank of 16 sequence patterns via Midi sysex dump. Set the sysex capable Midi receiver on record and dump the sequences by pressing **(Enter)**. This takes about 5 seconds. The display shows "busy" while sending and "finish" when the dumping has been done.

## 10.5 Midi Page 4 Sample Sysex Dump Functions

Go right with the cursor to enter the fourth page of the Midi menu. Here you can find several functions to save samples via sysex (system exclusive) dump. As these functions are very slow compared to SD card, we have limited the number of samples to 8.

DumpSampl	DumpAllSampl
-----------	--------------

### 10.5.1 DumpSample

Sends the contents of the currently by <Target> (see DISK) selected sample via Midi sysex dump. Set the sysex capable Midi receiver on record and dump the sample by pressing **(Enter)**. This takes about 60 seconds. The display shows "busy" while sending and "finish" when the dumping has been done.

### 10.5.2 DumpAllSampl

Sends the contents of the first 8 samples via Midi sysex dump. This takes about 10 minutes. The display shows "busy" while sending and "finish" when the dumping has been done.

## 11 The Sequencer

The Alpha Base has a step sequencer that is able to program rhythm patterns in the style of vintage Roland TR-X0X drum machines.

The sequencer has two basic modes:

The first mode is the classic drum triggering via 16 steps per measure with possible accent per step or not. Each instrument can be edited in real time while the rhythm pattern is playing, but the rhythm just triggers the instruments like a drum stick.

The second mode is also able to play back the pitch of each instrument plus an optional so-called parameter-lock (p-lock) per step. This is activated with the button SEQ = on.

We call it sequence mode. In sequence mode, the p-locks play back parameter changes like Midi CCs. P-locks can be, for example, changes of filter cutoff, LFOs or sample selects.

In sequence mode, the sounds can still be edited in real time but, for instance, the pitch may change or the p-locks override an edit just made.

### 11.1 Selecting Patterns

#### 11.1.1 Pattern Recall

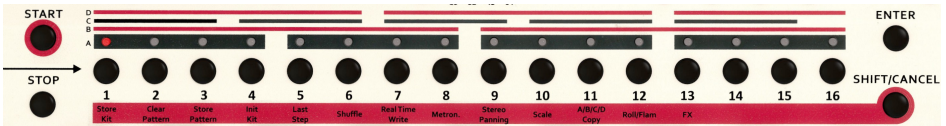

If the EDIT/TRIG LED is off, the **(Step)** buttons serve for selecting 16 patterns in a bank.

#### 11.1.2 Bank button



A maximum of 64 patterns are storable in memory organized in 4 banks with 16 patterns each. You can switch between the banks by pressing the **(Bank)** button. The currently selected bank is shown by the respective **(Bank LED) 1-4**.

Pattern as bank changes can be performed whilst the sequencer is running. The changes take effect immediately, without waiting for wrap-around to the new pattern.

### 11.1.3 Chaining of Patterns

Make sure the EDIT/TRIG LED is off, then press the CHAIN button so that the CHAIN LED is on. Now you can chain multiple patterns just by pressing and holding the current Step button and pressing another one at the same time.

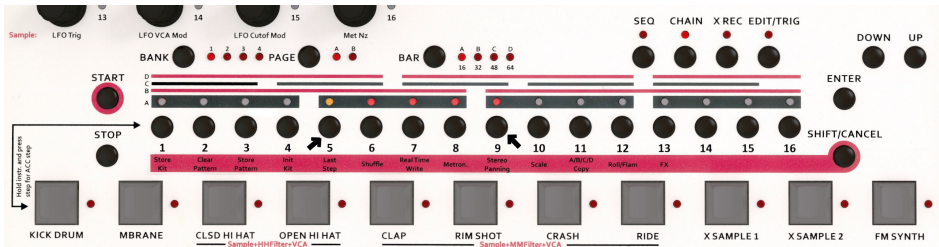

All step LEDs between the both steps light up and the selected patterns are played in a chain from left to right, beginning with the leftmost and cycling back after having played the last one. The currently played pattern blinks orange. The chain information is stored along with the first pattern of the chain. Don't forget to store the pattern with Pattern Quick Store (**Knob 15 click**) or Store Pattern (**Shift 3**).

If you unselect Chain mode, the actual pattern is played solo but, after reactivating Chain mode, the row plays in a chain loop. You can define different chain loops even for neighbored patterns, as the chain information is only stored in the first pattern.

## 11.2 Programming of Patterns

Basically, patterns can be programmed in two different ways. The first choice is to use the step sequencer where each 16<sup>th</sup> is assigned to a step button. When the sequencer is running, a green LED spot shows the currently played position. The second choice is to record it live (see Realtime Write).

This section describes the first option. First you should define the scale and length of the track (Last Step) as this defines the resulting measure. If you have initialized the pattern before (see Clear Pattern), you have always Scale = A and Last Step = 32 for all tracks which equals a 4/4 measure and an A/B bar scheme.

### 11.2.1 Setting or Clearing Steps – Programming Beats

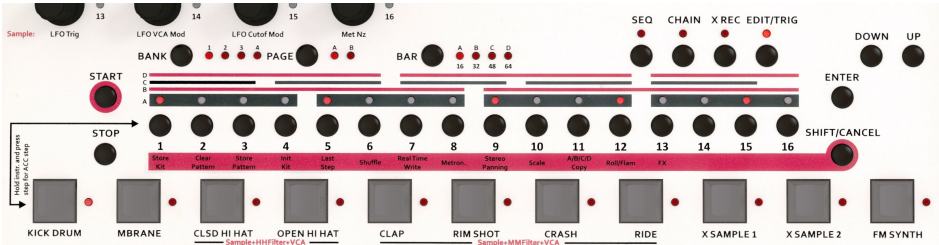

Press **(EDIT/TRIG)** so that the LED is on then select a track by pressing an instrument key. Press **(Start)** to let the sequencer play.

Each of the 16 **(Step)** buttons is assigned to a rhythm note. Set the rhythmic notes in your selected instrument track by pressing the desired **(Step)** buttons. Clear the notes by pressing the **(Step)** button again. The red LED will show if the step is set or not.

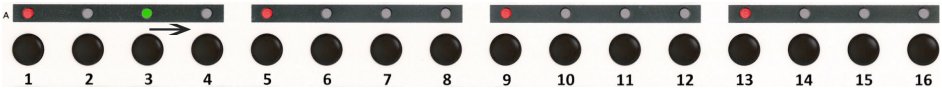

The running green LED spot shows which note is currently being played by the sequencer. The fixed red 16 LEDs show if the note is being played at this pointer or not.

### 11.2.2 Setting/Clearing Accents

If you want to set an accent, hold the **(Instrument)** key and press the **(Step)** button at the same time so that the formerly red step LED turns orange.

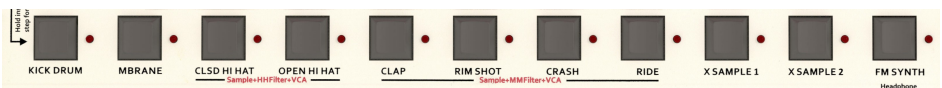
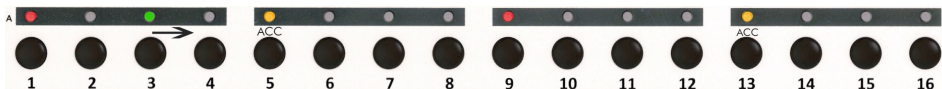

They are lit orange to indicate that an accent is being played on this step. If you want to unset an accent, press the **(Step)** button again whilst holding the **(Instrument)** key and the orange LED turns red again.

With accents you are able to program very dynamic patterns.

Each instrument has an own accent level that allows you to have different dynamics for different instruments.



### 11.2.3 BAR Button <A-D>

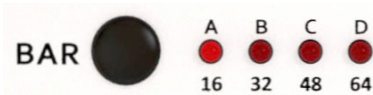

Each track actually consists of 64 steps, but Last Step limits the number of steps being played. Every track of the 11 instruments has its own Last Step. On default, this is set to 32 which means that the tracks play two bars of 16 steps, like two alternating measures.

See 2<sup>nd</sup> function (5) Last Step for how to change this.

The whole track of 64 is organized in 4 x 16 steps, called BAR A, B, C, D.

The BAR button switches between those bars, measures and cycles through the LEDs. If you want to edit BAR B, switch the BAR button to B and the pattern of this bar is displayed. You can edit the steps here as described before and switch back to BAR A. The BAR function automatically adapts to the limitation of Last Step. So if Last Step is e.g. 32, you can only select BAR A or B. If it is larger than 32, you can also switch to BAR C. Accordingly, if greater than 48, to BAR D.

If the sequencer is stopped, the LEDs show the currently selected bar for editing.

If the sequencer is running, the currently *played* bar LED flashes in the rhythm of the downbeat, whereas the *selected* bar LED (by BAR button) blinks brighter when it is played.

### 11.2.4 Scale <A-D>



The **(Scale)** function switches between clock dividers that produce different basic time bases for a played step. The source of the pattern timing is a clock that resolves 1/192<sup>th</sup> of a bar or 48 cpq (clocks per quarter). Scale can be used to create 32<sup>th</sup> notes or triplets if the beats are set accordingly to the marks (see picture above).

The stripes that are printed above the step LEDs indicate where the quarter downbeats of the selected Scale are.

*Please note that Scale C and D still form a 4/4 measure, only the beats between the downbeats are triplets and the downbeats are at different locations.*

The Scale function automatically defaults the Last Step value for all tracks so that every clocking yields a two-bar scheme again. The Scale should be defined before you start programming a pattern in order not to be confused where the downbeats are, but you can change it at any time.

Scale	Clock Division	Note per Step	Last Step
A	1/6	16 <sup>th</sup>	32
B	1/3	32 <sup>th</sup>	64
C	1/8	8 <sup>th</sup> Triplets	24
D	1/4	16 <sup>th</sup> Triplets	48

If you have selected for, instance, Scale (A), every **(Step)** button will resemble a 16<sup>th</sup> note. 16 steps make it a 4/4 measure.

But if you select Scale (C), every step plays an 8<sup>th</sup> triplet and you have to set the quarter beats to every 4<sup>th</sup> step to obtain a 4/4 measure again.

#### 11.2.4.1 Editing Scale:

Press **(Shift)** - all 16 step LEDs start to blink - and then select **(Step)** 10 = Scale. The display shows:

Scale = A

Now use the **(Data)** Wheel to change the scale. After your edit has been done, press **(Enter)** to leave the shift mode menu.

See 2<sup>nd</sup> functions for more information about the shift modes.

#### 11.2.5 Last Step <1-64>

The Last Step value is the number of steps being played before it wraps around and starts again with step 1. This is 16 for a typical one-bar-pattern and 32 for a two-bar alternating pattern. But it can have any number in between 1-64, like 12 for instance which would be a measure of  $\frac{3}{4}$  or the double of it (= 24) for two bars. A classic 5/4 measure would require Last Step = 20. Assuming Scale = A.

Each track in the Alpha Base can have a different track length. That means you can produce polyrhythmic shifts between different tracks.

If you want to change all tracks at the same time, turn off Edit mode. With Edit mode off, all tracks get the same Last Step – this is useful if you want to change the meter of a pattern in general.

If you want to change only one track, turn on Edit mode and select the track you want to change and keep Edit mode on.

Press **(Shift)** - all 16 step LEDs start to blink - and then select (Step) 5 = Last Step. The display shows:

```
Last Step = 32
```

Now use the **(Data)** Wheel to change the Last Step. You can hear the result immediately. The function automatically resets the playing pattern counter if you cross the currently played step position, that is if the counter is, for example, on position 30 and you turn Last Step down to 24, the counter would be in infinity and beyond. After your edit has been done, press **(Enter)** to leave the shift mode menu.

### 11.2.6 A/B/C/D Copy function

If you have programmed a nice beat on BAR A, you would need to copy this rhythm pattern to BAR B in order to make only slight variations on the alternating played bars. Depending on the currently selected BAR and the Last Step setting of the track you have selected, the function offers copying from BAR A to B but also BAR B to A, or BAR B to C if the track length **(Last Step)** allows to extend to other bars. The target is selected by the BAR button.

Press **(Shift)** - all 16 step LEDs start to blink - and then select **(Step)** 11 = A/B/C/D Copy. The display shows:

```
Copy A to B  
Use BAR to select destin
```

Now use the **(BAR)** button to select the destination. Depending on the track length **(Last Step)** you can either choose just B, or B/C, or B/C/D.

```
Copy A to C  
Use BAR to select destin
```

After your choice has been made, press **(Enter)** to copy the bar A to your destination. If you want to copy from another bar, say B, choose the bar *before* you press shift 11 and *then* you can choose the other bars except the source bar.

### 11.2.7 Shuffle <000-011>

The Alpha Base can shuffle or swing the beats between two neighboured steps away from the exact metronomic midpoint to make them more lively. The swing factor is applied on every second 16<sup>th</sup> step.

You can either change the shuffle value for all tracks together (**Global Shuffle**) or just for one track (**Track Shuffle**). If you are in Edit mode, only the selected track gets shuffled. If you are not in Edit mode, all tracks get the same shuffle amount.

Press (**Shift**) - all 16 step LEDs start to blink - and then select (**Step**) 6 = Shuffle. The display shows:

```
Shuffle = 000
Global Shuffle
```

The second row shows which kind of shuffle you are about to edit: Global or Track Shuffle.

Now use the (**Data**) Wheel to change the Shuffle value. You can hear the result immediately. There are 11 stages of shuffling possible, according to the 12 micro-steps between two beats at scale A.

After your edit has been done, press (**Enter**) to leave the shift mode menu.

### 11.2.8 Roll/Flam

The sequencer of the Alpha Base is able to play several very short hits after one note until the next note called flam. Drummers call it "flam" when one or two short hits come *after* the actual note and "roll" if two or more hits come *before* the actual note. Well, you can program the number and the position of the double, triple or multiple hits between two steps. It's your choice, if you set a step after the flam step, to have a roll or have a single beat with flam – meaning some extra hits after the note.

Be sure you are in Edit mode and have your desired track selected. Now double click on a (**Step**) button to activate a roll/flam on the particular step. The step LED starts to blink and the display shows:

```
K Tune Pitch Decay Harm
Roll/Flam set 80 000
```

If you want to clear the roll/flam step, double click on the step button again. The step LED stops blinking and the display shows:

```

K Tune Pitch Decay Harm
Roll/Flam cleared 000

```

Regardless of the active roll/flam step, you can set or clear the step to be played and set or unset accent on that step. The step stays blinking roll/flam step as long as you don't clear it by double click.

Now let's program the flam pattern. You probably won't hear the flam at first as it is default-wise set to a very short time.

Press **(Shift)** - all 16 step LEDs start to blink - and then select **(Step) 12** = Roll/Flam. The display shows:

```

Roll/Flam= _█-----
Double click to set roll

```

The bar shows the position of the second hit after the most recent note. There are 12 positions of bars between the most recent step and the next beat.

Now use the **(Data)** wheel to select another flam pattern. See the bar move and you can hear the result immediately.

```

Roll/Flam= ___█-----
Double click to set roll

```

There are 60 different flam patterns. The lower move the double hit to various positions, but then you can have two or more extra hits. The last flam pattern has all 12 extra hits set and sounds almost like an oscillator.

```

Roll/Flam= __█---█---█
Double click to set roll

```

Select your desired flam pattern and press **(Enter)** to leave the function.

*Note: every track has its own roll/flam pattern.*

### 11.2.9 Store Pattern / Copy Function

After your pattern edits have been made, you need to store the pattern in order to save it for the next power cycle.

There are 2 storage memories in the Alpha Base: RAM (random access memory) and flash memory. The flash memory is permanent while the RAM only stores while the unit is powered on. On powering up, the Alpha Base copies the content of the permanent memory to the RAM.

## Version OS 1.2

However, due to the flash memory hardware, the DSP driven algorithms that access the flash memory (Samples, LFOs, CV Envelopes) have to be shut down during the storing process. Although the sequencer keeps running, there are a couple of seconds where the instruments sound different or are muted completely.

For that reason, we have implemented a quick-store function that stores your work quickly to RAM but doesn't interrupt the workflow.

Press and click (**Knob 15**) to quick-store the pattern to RAM. The RAM stores all presets and patterns temporarily. You can change patterns and you don't lose your programming. The display shows briefly

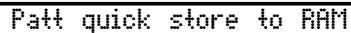

```
Patt quick store to RAM
```

In order to keep the edited data after next power cycle, you have to transfer the data to flash memory.

This is done with Shift 3 (**Store Pattern**).

Press (**Shift**) - all 16 step LEDs start to blink - then select (**Step**) 3 = Store Pattern. The display shows:

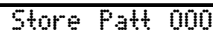

```
Store Patt 000
```

Now you have the choice to either store immediately by pressing (**Enter**), or to store the edits you have made to another location. This is basically a copy function because the source pattern in the upper line will not be overwritten in this case (also you don't have to make edits, just open the store pattern function on a pattern you wish to copy). As soon as you turn the (**Data**) wheel or press the (**Up/Down**) buttons, the display shows the destination:

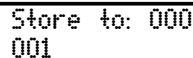

```
Store to: 000  
001
```

The step and bank LEDs follow the destination pattern number.

If you press (**Enter**), the pattern gets stored to permanent flash memory. The display monitors the progress of flash programming.

### 11.3 SEQ Mode

The Sequence Mode is activated if you press the **(SEQ)** button. In this mode every instrument's pitch is played by the sequencer. Moreover, parameter-locks can be programmed to change certain parameters over the track dynamically. If SEQ Mode is off, the instruments only get triggered and return to their normal pitch.

#### 11.3.1 Pitch Sequence

Right after the **(SEQ)** button is pressed, the display changes to the pitch sequencer screen:



The black bars indicate active steps and the crosses show empty steps. The 4x4 knob matrix shows the sequencer steps as well, except that four steps are one row of encoders. The LED next to them show the step sequencer. The running green LED spot also runs through the knob matrix LEDs.

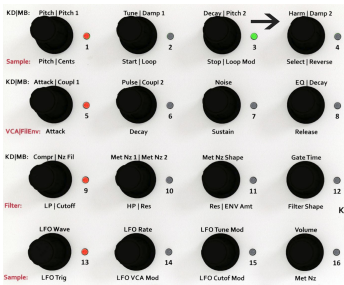

Now turn the knobs of the active steps and you can create a melody for the beats. Only the active steps can be edited.

If you set or clear steps it will be updated in the display and the knob matrix as well.

Each pixel of the bar stands for one semitone of the instrument tune (with the analog instruments it's not exact semitones). The pitch of the sequence is added to the internal tune of the instrument. The maximum pitch control is 24 semitones = two octaves. The bar rolls over after an octave.



Please note that the pitch sequence is just stored within the pattern structure. With any other preset recalled it plays the same melody.

If you want to edit the sounds or select kits, press the **(KIT/SEQ)** button to flip between sound editing, kit select mode or back to sequence mode programming.

### 11.3.2 Parameter Locks

In addition to the pitch sequence there is the possibility to have a parameter change per step called parameter-lock. The p-locks work internally like Midi CC messages. They can trigger manifold functions, basically all editable parameters and even whole instrument changes if you are in Multi Mode.

Please note that only one p-lock per step is possible. Basically, the most used parameter change certainly is the tuning, but this is covered by Pitch Sequence (see above) already and is available for every track at every step location.

P-locks also can be used on non-played steps, so a multiple parameter change is possible if you set another change on a non-played step before the actual step.

The other thing to consider is the fact that p-locks are not changed back to the initial setting of the sound. If you recall a sound by entering a preset and a p-lock changes, for example, the sample select on one position, you have to change back the sample select at another location or the preset will always have a changed value as long as you play it back in **(SEQ)** mode.

If Sequencer Mode is off, no p-locks and no pitch sequences are played back.

#### 11.3.2.1 Setting p-locks

Be sure **(SEQ)** is on and you are in Edit mode and have your instrument track selected. Switch the **(KIT/SEQ)** button to the sound editing screen. Now press and hold the **(Step)** button of the note where you want to change your parameter, e.g. step 5.

While holding the button, turn the encoder of the desired parameter to change (e.g. **KD Decay**), and the display briefly shows:

```

K| Tune Pitch Decay Harm
Lockd 2step 084 000
  
```

The held step LED starts to blink and the p-lock information (in our example decay) is now written to this step. Press another location (e.g. step 13) and do the same there but change the decay to another value. If a step is erased during p-lock programming, set it again.



Now you can see and hear that the decay value changes when the sequencer comes across the programmed steps. If you are still in Edit mode of this track and in sound editing mode, the display shows the locked values jumping.

### 11.3.2.2 Setting Instrument Select as p-locks

It's even possible to p-lock an instrument selection.

This is a complex p-lock as the whole instrument with all parameters is recalled on a step. Follow this list:

- Switch to Multi Mode = Click on Knob 12.
- Go right with the cursor to the number of the desired instrument you want to change (see also 8.1.1 Selecting an Instrument in Multi Mode).
- Turn on **(SEQ)** if it wasn't before.
- Turn on Edit mode if it wasn't before .
- Press again **(KIT/SEQ)** so that you are in Kit/Instrument select menu.
- Now press and hold a desired step and turn the **(Data)** wheel, not a parameter knob. The instrument selection gets recorded into that step.
- Do this with other steps

The instrument selection playback works even in Single Mode, though p-lock programming is only possible in Multi Mode.

*Please note that after clearing **(SEQ)** you would have to recall the preset again to have the original instrument because the instrument recall is not updated automatically.*

### 11.3.2.3 Editing p-locks

A parameter-lock that is stored in one step of a track actually consists of three pieces of information:

1. Parameter (CC number) and
2. Value (CC amount).
3. P-Lock active or not

As stated before, the p-locks work internally exactly like CC Midi controllers. See the list of CCs in the appendix. You are able to edit the value of a p-lock location. That is useful if you want to edit e.g. the sweep of the filter cutoff over a couple of steps.

Switch **(KIT/SEQ)** to enter the pitch sequencer display:

```

Pitch Sq
█xxx█xxx,xxx█xxxKick Dnm

```

Now go right with the cursor and the screen shows the parameter locks - if there are any:

```

Lock Sq
x█xxx█xxxxxxxx,xxxKick Dnm

```

The bar indicates that a p-lock has been written to a step and the height of it shows the value of the p-lock.

Now go right with the cursor to the position of the p-lock you want to edit. Once you have reached a step with a written p-lock, the number of the corresponding CC and the value is displayed:

```

Lock 102
xxx█xxx█xxxxxxxx,xxxKick 065

```

We have taken the example from above with the decay. Kick drum decay is CC 102. Now turn the **(Data)** wheel and edit the value of the selected p-lock. The value in the second line gets updated

*Note that only values, not CC numbers can be edited.* In order to change a CC, you have to create another p-lock that overrides the previous one.

### 11.3.2.4 Setting or Clearing p-locks

In order to clear or activate a p-lock, select the p-lock with the cursor in the Lock Step screen.

Then press and click (**Knob 13**), and the p-lock will be cleared:

```
Lock 5q  
xxxx█xxxxxxxxxxxxKick Drm
```

Or be set again:

```
Lock 102  
xxxx█xxxxxxxx,xxxKick 018
```

## 12 2nd Functions

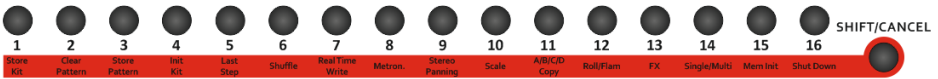

Each of the 16 (**Step**) buttons corresponds to a second function. When you press the (**Shift/Cancel**) button, all 16 red LEDs flash. By pressing the desired (**Step**) button you can enter the desired menu. The printed text on the red strip below the (**Step**) buttons informs you of their assigned function.

To cancel the shift function press (**Shift/Cancel**) again, and the display reads "Command aborted". The LEDs stop flashing and after about 2 seconds the menu returns to the previous menu.

*Note: some of the pattern-related functions were already described in chapter 11 The Sequencer and are listed here as well.*

### 12.1 Store Kit (1)

With this function you store the current drum kit to a memory location. All sound parameters are just edited in a volatile buffer. To keep this edit buffer in permanent memory, you have to store it to memory by the Store Kit function.

Press (**Shift/Cancel**) - all 16 step LEDs start to blink - then select (**Step 1**) = Store Kit. The display shows:

```
Store Kit 000
```

Now you have the choice to either store immediately by pressing (**Enter**), or to store the edits you have made to another location. This is basically a copy function because the source Kit in the upper line will not be overwritten in this case (also you don't have to make edits, just open the Store Kit function on a Kit you wish to copy). As soon as you turn the (**Data**) wheel or press the (**Up/Down**) buttons, the display shows the destination:

```
Store to: 000
001
```

If you press (**Enter**), the kit gets stored to permanent flash memory. The display monitors the progress of flash programming.

## 12.2 Clear Pattern (2)

With this function you can clear the pattern edit buffer. The whole pattern is managed in a temporary edit buffer as well. In order to clear it, first choose it. Press **(Shift/Cancel)** and then **(Step 2)**. Now the display shows:

```
Clear Pattern?
```

Just confirm with the **(Enter)** button, and the pattern in edit buffer gets erased. As long you don't store it, the old pattern in memory remains unchanged.

## 12.3 Store Pattern (3)

Press **(Shift/Cancel)** - all 16 step LEDs start to blink - then select **(Step 3)** = Store Pattern. The display shows:

```
Store Patt 01 Bank 1
```

Now you have the choice to either store immediately by pressing **(Enter)**, or to store the edits you have made to another location. This is basically a copy function because the source pattern in the upper line will not be overwritten in this case (also you don't have to make edits, just open the store pattern function on a pattern you wish to copy). As soon as you turn the **(Data)** wheel or press the up/down buttons, the display shows the destination:

```
Store to: 01 Bank 1  
Patt 02 Bank 1
```

The step and bank LEDs follow the destination pattern number.

If you press **(Enter)**, the pattern gets stored to permanent flash memory. The display monitors the progress of flash programming.

**Note:** If you are storing a kit **or** a pattern to permanent flash memory in any mode, the global flags like Preset Number, Single/Multi, CHAIN, SEQ, Midi Flags are stored along and are recalled with the next power cycle.

## 12.4 Init Kit (4)

With this function you can initialize the Preset Kit sound edit buffer. The Kit is managed in a temporary edit buffer. The function is useful to have as a basic kit from where you can create a new preset.

Press **(Shift/Cancel)** and then **(Step 4)**. Now the display shows:



Clear Preset?

Just confirm with the **(Enter)** button, and the Preset Kit edit buffer gets initialised. As long you don't store it, the old Preset Kit in memory remains unchanged.

## 12.5 Last Step (5)

With function Last Step you can change the number of steps of a track. You can choose a number from 1 to 64 steps. Default value is 32 which allows for 2 alternating bars.

If you want to change all tracks at the same time, turn off Edit mode. With Edit mode off, all tracks get the same Last Step – this is useful if you want to change the meter of a pattern in general.

If you only want to change one track, turn on Edit mode and select the track you want to change and leave Edit mode on.

Press **(Shift/Cancel)** - all 16 step LEDs start to blink - and then select **(Step 5)** = Last Step. The display shows:

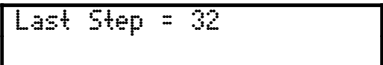

Last Step = 32

Now use the **(Data)** Wheel to change the Last Step. You can hear the result immediately. After your edit has been done, press **(Enter)** to leave the shift mode menu. Don't forget to store the edits or they will disappear when you change the pattern.

## 12.6 Shuffle (6)

The Alpha Base can shuffle or swing the beats between two neighboured steps away from the exact metronomic midpoint to make them more alive. The swing factor is applied on every second 16<sup>th</sup> step.

You can either change the shuffle value for all tracks together **(Global Shuffle)** or just

for one track (**Track Shuffle**). If you are in Edit mode, only the selected track gets shuffled. If you are Edit mode is off, all tracks get the same shuffle amount.

Press (**Shift/Cancel**) - all 16 step LEDs start to blink - then select (**Step 6**) = Shuffle. The display shows:

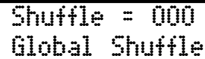

```
Shuffle = 000
Global Shuffle
```

The second row shows which kind of shuffle you are about to edit: Global or Track Shuffle.

Now use the (**Data**) Wheel to change the Shuffle value. You can hear the result immediately. There are 11 stages of shuffling possible, according to the 12 micro-steps between two beats at scale A.

After your edit has been done, press (**Enter**) to leave the shift mode menu.

Don't forget to store the edits or they will disappear when you change the pattern.

## 12.7 Realtime Write (7)

This function is useful for live recording of instruments. Activate the Realtime Write function with (**Shift/Cancel**) + (**Step 7**). The display shows:

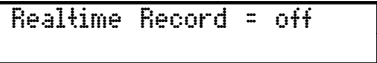

```
Realtime Record = off
```

Now turn it on by turning the (**Data**) wheel right

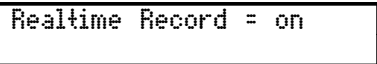

```
Realtime Record = on
```

Press (**Enter**) to confirm. The Realtime Write function automatically sets the metronome on. You can hear a cow bell playing on the 4 downbeats.

Be sure to be in Edit Mode = off. Start the sequencer and record your drum pattern by playing the instrument keys. To stop realtime recording enter this page again and set Realtime Record to <off>.

» **Note:** *As with manual step editing, only the edit buffer is recorded. You have to store it or the pattern will be discarded once you select the next pattern.*

## 12.8 Metronome (8)

Here you can turn the metronome on or off. In Realtime Write Mode, the metronome is automatically activated, but you can turn it on and off at any time you wish.

Press **(Shift/Cancel)** - all 16 step LEDs start to blink - then select **(Step 8)** = Metronome. The display shows:



```
Metronome = off
```

With the **(Data)** wheel you can select <on> or <off>. Press **(Enter)** to confirm.

## 12.9 Stereo Panning (9)

This function opens the stereo panning page.

Press **(Shift/Cancel)** - all 16 step LEDs start to blink - then select **(Step 9)** = Stereo Panning. The display shows:



```
Instrument Pan  
Press enter
```

Now press **(Enter)** and the panning section opens. The pages are similar to an instrument edit page and can be reached by turning the knobs of the 4x4 knob matrix.

Note that the analog instruments KD, MB, CH, OH, CLAP, RIM, CRASH, RIDE only have a phase shift panning that has a minor effect and can cause distortions if the level is too high. This is due to the hardware of the converters and cannot be changed.

We recommend leaving them centered and using the single outputs with an external mixer to pan them in the stereo mix. For professional recordings, this is the always the better way as the single outputs give the purest and best quality signal of the analog instruments possible.

The purely digital instruments X1, X2 and FM use a regular level pan in the stereo mix.

On the last page, some extra parameters for the FM synth like FM Volume and voice count are placed in the pan section as well.



### 12.9.1 Stereo Pan KD, MB, CH, OH Page 1

P	KDpan	MBpan	CHpan	OHpn
N	063	063	063	063

#### 12.9.1.1 Kick Drum Pan <000-127, 63=Center)

#### 12.9.1.2 MBrane Pan <000-127, 63=Center)

#### 12.9.1.3 Closed HiHat Pan <000-127, 63=Center)

#### 12.9.1.4 Open HiHat Pan <000-127, 63=Center)

### 12.9.2 Stereo Pan Clap, Rim, Crash, Ride Page 2

P	CPpan	RMpan	CRpan	RDpn
N	063	063	063	063

#### 12.9.2.1 Clap Pan <000-127, 63=Center)

#### 12.9.2.2 Rim Pan <000-127, 63=Center)

#### 12.9.2.3 Crash Pan <000-127, 63=Center)

#### 12.9.2.4 Ride Pan <000-127, 63=Center)

### 12.9.3 Stereo Pan X1, X2, X Input Mono/Stereo, Init Page 3

```
P X1pan X2pan XinMo Init  
N 063 063 063 000
```

#### 12.9.3.1 X1 Pan <000-127, 63=Center)

#### 12.9.3.2 X2 Pan <000-127, 63=Center)

#### 12.9.3.3 X Input Mono/Stereo <on/off>

This function decides if the input signals on the external sampling inputs are mono mixed to both channels = <on>, or not <off> = default. In stereo mode = <off>, the left sample input is assigned to X1, the right to X2.

#### 12.9.3.4 Initialise Panning

This function initialises all pan settings. If you turn right, the display shows "done" and all pannings are set to their default center value <063>.

#### 12.9.4 Stereo Pan X1, X2, X Input Mono/Stereo, Init Page 4

```
P FMpan FMspa FMvoi FVol  
N 063 000 .063 099
```

##### 12.9.4.1 FM Pan

Controls the panning of the FM synth as a whole.

##### 12.9.4.2 FM Spatial

Controls the spatial left/right panorama of the four operators of the FM synth.

##### 12.9.4.3 FM Number of Voices <001-006>

Controls the maximum number of voices for the FM synth. When played by a keyboard, this value limits the number of voices when the chord wraps around and a new voice is stolen from an old. Internally only the limited number of voices will be played back as a chord.

##### 12.9.4.4 FM Volume

Controls the volume of the FM synth.

#### 12.10 Scale (10)

Press **(Shift/Cancel)** - all 16 step LEDs start to blink - and then select **(Step 10)** = Scale. The display shows:

```
Scale = A
```

Now use the **(Data)** wheel to change the scale. After your edit has been done, press **(Enter)** to leave the shift mode menu.

### 12.11 A/B/C/D Copy (11)

The source bar is selected by the **(BAR)** button of the currently edited track.

Press **(Shift/Cancel)** - all 16 step LEDs start to blink - then select **(Step 11)** = A/B/C/D Copy. The display shows:

```
Copy A to B
Use BAR to select destin
```

Now use the **(BAR)** button to select the destination. Depending on the track length **(Last Step)** you can either choose B alone, or B/C, or B/C/D.

```
Copy A to C
Use BAR to select destin
```

After your choice has been made, press **(Enter)** to copy the bar A to your destination. If you want to copy from another bar, say B, choose the bar *before* you press shift 11 and *then* you can choose the other bars except the source bar.

### 12.12 Roll/Flam (12)

This function edits the played flam pattern of a flam set to a step of a track.

Press **(Shift/Cancel)** - all 16 step LEDs start to blink - then select **(Step 12)** = Roll/Flam. The display shows:

```
Roll/Flam= _█-----
Double click to set roll
```

The bar shows the position of the second hit after the actual note. There are 12 positions of bars between the actual step and the next beat.

Now use the **(Data)** wheel to select another flam pattern. See the bar move and you can hear the result immediately.

```
Roll/Flam= ___█-----
Double click to set roll
```

There are 60 different flam patterns.

```
Roll/Flam= __█ █-----
Double click to set roll
```

Select your desired flam pattern and press **(Enter)** to leave the function.

*Note: every track has its own roll/flam pattern.*

### 12.13 FX (13)

This function opens the effects page.

Press **(Shift/Cancel)** - all 16 step LEDs start to blink - and then select **(Step 13)** = FX. The display shows:

```
Effects Program
Press enter
```

Now press **(Enter)** and, depending on the current page selected, the Reverb or the Delay section opens. For more information, refer to chapter 7.5 Effects.

### 12.14 Single/Multi Mode (14)

Press **(Shift/Cancel)** and then **(Step 14)** to switch between Single Mode and Multi Mode. The display shows:

```
Mode Select
Single Mode_
```

Turn the **(Data)** wheel to choose the desired mode and then press **(Enter)**.

```
Mode Select
Multi Mode_
```

The functions are described in detail in chapter 8: Single/Multi Mode.

### 12.15 Memory Init (15)

Press **(Shift/Cancel)** and then **(Step 15)** to initialize the whole RAM memory. The display shows:

```
Init RAM Preset + Seq
```

If you press **(Enter)**, the entire RAM memory including all presets, multi kits and patterns gets initialised to default values.

**Caution:** this *only* affects the RAM (random access memory), not the permanent flash

memory *as long as you don't* store with **(Shift 1)** nor **(Shift 3)**.

So if you erratically have initialised all memory with this shift function, turning the unit off and on brings back all your previously permanently stored presets!

## 12.16 Shut down (16)

This function works similar to a PC that has to be shut down rather than just turning it off. As described in section DISK, the Alpha Base has a flash memory that needs to turn off parts of the DSPs whilst writing memory blocks. Although the sequencer keeps on running, the instruments are muted or sound different.

For this reason, the quick store functions, Encoder click 15 **(Quick Store Pattern)** and 16 **(Quick Store Preset)**, are implemented. However, they only store to RAM. If you forget to store to flash memory via shift 1 **(Store Kit)** or shift 3 **(Store Pattern)**, all your work will be gone.

This function stores all RAM buffers to flash memory and creates a backup file on SD card. It is the counterpart to DISK function "Load backup file restore presets+pattern". You can also use this function to have a state of the machine that you later on want to restore from SD-Card. After having stored everything, the Alpha Base has to be turned off.

Press **(Shift/Cancel)** - all 16 step LEDs start to blink - and then select **(Step 16)** = Shutdown. The display shows:

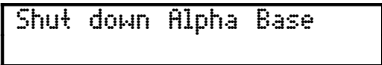

```
Shut down Alpha Base
```

Make sure you have a working SD card inserted. Now press **(Enter)** and see the progress of write operations until the screen shows:

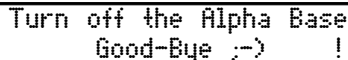

```
Turn off the Alpha Base  
Good-Bye ;-)> !
```

Now you have to turn off the unit.

## 13 Appendix

### 13.1 MIDI Implementation

#### 13.1.1 Midi Note Commands

Each instrument has its own channel to send or receive midi notes. The note number is added to the pitch of the instrument. The basic internal tuning is on note C1 (36) and is added from there on to the internal pitch.

Instrument	Note Number	Note	Channel
Kick Drum	36-97	C1-C6	1
Snare Drum	36-97	C1-C6	2
Closed Hi Hat	36-97	C1-C6	3
Open Hi Hat	36-97	C1-C6	4
Clap	36-97	C1-C6	5
Rim Shot	36-97	C1-C6	6
Crash	36-97	C1-C6	7
Ride	36-97	C1-C6	8
X1 Sample	36-97	C1-C6	9
X2 Sample	36-97	C1-C6	10
FM Synth (max. 6 voices polyph.)	36-97	C1-C6	11

On channel 16, the Alpha Base offers a key mapping for all instruments. Each instrument maps 4 notes on the keyboard. The pitch is added according to the 4 notes.

Instrument	Note Number	Note	Delta Pitch (semitones)	Channel
Kick Drum	36-39	C1-D#1	0, 6, 12, 18	16
Snare Drum	40-43	E1-G1	0, 6, 12, 18	16
Closed Hi Hat	44-47	G#1-B1	0, 6, 12, 18	16
Open Hi Hat	48-51	C2-D#2	0, 6, 12, 18	16
Clap	52-55	E2-G2	0, 6, 12, 18	16
Rim Shot	56-59	G#2-B2	0, 6, 12, 18	16
Crash	60-63	C3-D#3	0, 6, 12, 18	16
Ride	64-67	E3-G3	0, 6, 12, 18	16
X1 Sample	68-71	G#3-B3	0, 6, 12, 18	16
X2 Sample	72-75	C4-D#4	0, 6, 12, 18	16
FM Synth (fixed chord)	76-79	E4-G4	0, 6, 12, 18	16

**13.1.2 Program Change**

<b>Function</b>	<b>Value</b>	<b>Channel</b>
Instrument recall as Multi Kit	0-127	1-11 (instrument's channel)
Single Preset recall	0-127	12
Multi Kit recall	0-127	13
Sequence pattern recall	0-63	14

**13.1.3 Sound Parameter (Continuous Controllers)**

<b>KICK DRUM CH1</b>	<b>Controller No.</b>	<b>Value range</b>
Tune	100	0-127
Pitch	101	0-127
Decay	102	0-127
Harmonics	103	0-127
Pulse	104	0-127
Noise	105	0-127
Attack	106	0-127
EQ	107	0-127
Compression	113	0-127
Gate time	114	0-127
Metallic Noise	115	0-127
LFO Wave	119	0-63
LFO Intensity	121	0-127
LFO Rate	122	0-127
Envelope Attack	90	0-127
Envelope Decay	91	0-127
Envelope Amount	116	0-127
Select Instrument for Multi Kit	64	0-127
Volume	7	0-127



<b>MBRANE CH2</b>	<b>Controller No.</b>	<b>Value range</b>
Pitch 1	108	0-127
Dampen 1	93	0-127
Pitch 2	111	0-127
Dampen 2	97	0-127
Coupling 1 → 2	101	0-127
Coupling 2 → 1	103	0-127 Center 63
Noise Level	109	0-127
Decay	110	0-127
Metallic Noise 1	107	0-127
Metallic Noise 2	116	0-127
Gate time	114	0-127
LFO 1 Wave	119	0-63
LFO 1 Intensity	121	0-127
LFO 1 Rate	122	0-127
LFO 2 Wave	123	0-63
LFO 2 Intensity	124	0-127
LFO 2 Rate	125	0-127
Envelope 1 Attack	90	0-127
Envelope 1 Decay	91	0-127
Envelope 1 Amount	92	0-127
Envelope 2 Attack	94	0-127
Envelope 2 Decay	95	0-127
Envelope 2 Amount	96	0-127
Select Instrument for Multi Kit	64	0-127
Volume	7	0-127

<b>SAMPLE CH3-CH10</b>	<b>Controller No.</b>	<b>Value range</b>
Sample Tune	100	0-127
Sample Cents	99	0-127
Sample Start	101	0-127
Sample Stop	102	0-127
Sample Loop	97	0-127
Sample Select	103	0-127
VCA Envelope Attack	104	0-127
Filter Envelope Attack	105	0-127
VCA Envelope Decay	106	0-127
Filter Envelope Decay	107	0-127
VCA Envelope Sustain	108	0-127
Filter Envelope Sustain	109	0-127
VCA Envelope Release	110	0-127
Filter Envelope Release	111	0-127
Filter Cutoff (LP on HH)	112	0-127
Filter Resonance	113	0-127
Filter Hi Pass (only HH)	114	0-127
Filter Envelope Amount	115	0-127
Filter Mode	116	0-1(HH) 0-3(CLP-RID)
LFO Synchronization	96	0-1
LFO Wave	119	0-63
LFO Rate	122	0-127
LFO Tune Amount	121	0-127
LFO VCA Amount	124	0-127
LFO Filter Amount	125	0-127
Metallic Noise	94	0-127
Switch CC	65	1-0:Reverse on/off 3-2: Loop on/off
Select Instrument for Multi Kit	64	0-127
Volume	7	0-127

<b>FM Synth CH11</b>	<b>Controller No.</b>	<b>Value range</b>
OP1 Tune	100	0-127
OP2 Tune	101	0-127
OP3 Tune	102	0-127
OP4 Tune	103	0-127
FM Amount 1→2	104	0-127
FM Amount 1→3	105	0-127
FM Amount 1→4	106	0-127
FM Amount 2→1	107	0-127
FM Amount 2→3	108	0-127
FM Amount 2→4	109	0-127
FM Amount 3→1	110	0-127
FM Amount 3→2	111	0-127
FM Amount 3→4	112	0-127
FM Amount 4→1	113	0-127
FM Amount 4→2	114	0-127
FM Amount 4→3	115	0-127
OP1 Env Attack	14	0-127
OP2 Env Attack	15	0-127
OP3 Env Attack	16	0-127
OP4 Env Attack	17	0-127
OP1 Env Decay	18	0-127
OP2 Env Decay	19	0-127
OP3 Env Decay	20	0-127
OP4 Env Decay	21	0-127
OP1 EG→VCA Amount	22	0-127
OP2 EG→VCA Amount	23	0-127
OP3 EG→VCA Amount	24	0-127
OP4 EG→VCA Amount	25	0-127
OP1 EG→FM Amount	26	0-127
OP2 EG→FM Amount	27	0-127
OP3 EG→FM Amount	28	0-127
OP4 EG→FM Amount	29	0-127
Select Instr (Multi Kit)	64	0-127
Max Voices (Polyphony)	30	0-5
Volume	7	0-127

**Global Controllers on Channel 16**

<b>FX Reverb</b>	<b>Controller No.</b>	<b>Value range</b>
Room Size	100	0-127
Low Pass Reflections	101	0-127
Hi Pass Reflections	102	0-127
Reverb Level	103	0-127
KD Reverb Amount	104	0-127
MB Reverb Amount	105	0-127
CH Reverb Amount	106	0-127
OH Reverb Amount	107	0-127
CLP Reverb Amount	108	0-127
RIM Reverb Amount	109	0-127
CRH Reverb Amount	110	0-127
RID Reverb Amount	111	0-127
X1 Reverb Amount	112	0-127
X2 Reverb Amount	113	0-127
FM Reverb Amount	114	0-127

<b>FX Delay</b>	<b>Controller No.</b>	<b>Value range</b>
Delay Time	14	0-127
Delay Feedback	15	0-127
Delay Spatial	17	0-127
Delay Level	18	0-127
KD Delay Amount	19	0-127
MB Delay Amount	20	0-127
CH Delay Amount	21	0-127
OH Delay Amount	22	0-127
CLP Delay Amount	23	0-127
RIM Delay Amount	24	0-127
CRH Delay Amount	25	0-127
RID Delay Amount	26	0-127
X1 Delay Amount	27	0-127
X2 Delay Amount	28	0-127
FM Delay Amount	29	0-127

<b>MUTE Global</b>	<b>Controller No.</b>	<b>Value range</b>	<b>Internal Range</b>
KD	93	0,1	Off, On
MB	93	2,3	Off, On
CH	93	4,5	Off, On
OH	93	6,7	Off, On
Clap	93	8,9	Off, On
Rim	93	10,11	Off, On
Crash	93	12,13	Off, On
Ride	93	14,15	Off, On
X1	93	16,17	Off, On
X2	93	18,19	Off, On
FM	93	20,21	Off, On

<b>Stereo PAN</b>	<b>Controller No.</b>	<b>Value range</b>	<b>Internal Range</b>
MB	34	0-127	0-127 64=Center
CH	35	0-127	0-127 64=Center
OH	36	0-127	0-127 64=Center
Clap	37	0-127	0-127 64=Center
Rim	38	0-127	0-127 64=Center
Crash	39	0-127	0-127 64=Center
Ride	40	0-127	0-127 64=Center
X1	41	0-127	0-127 64=Center
X2	42	0-127	0-127 64=Center
FM	43	0-127	0-127 64=Center

### **Store Instruments via Midi Controller**

Controller 62 • Value: 64

### **13.1.4            3. Sysex Commands**

Single Preset bulk dump

\$F0(SysEx begin), \$31(JoMoX-manufact. code), \$7F(Command Sys Ex dump), \$5D(Product code), \$01(Single Preset),\$55, XX(Data0),XX(Data1),..., \$F7(End of SysEx)

Single Pattern bulk dump

\$F0(SysEx begin), \$31(JoMoX-manufact. code), \$7F(Command Sys Ex dump), \$5D(Product code), \$02(Single Pattern),\$55, XX(Data0),XX(Data1),..., \$F7(End of SysEx)

Single Sample bulk dump

\$F0(SysEx begin), \$31(JoMoX-manufact. code), \$7F(Command Sys Ex dump), \$5D(Product code), \$03(Single Sample),\$55, \$00(14 Bit Sample No HB), \$00(14 Bit Sample No LB), \$77,XX(Data0),XX(Data1),..., \$F7(End of SysEx)

OS bulk dump

\$F0(SysEx begin), \$31(JoMoX-manufact. code), \$7F(Command Sys Ex dump), \$5D(Product code), \$10(CodeUpdate),\$55, \$00(14 Bit Block ID HB), \$00(14 Bit Block ID LB), \$77, XX(Data0),XX(Data1),..., \$F7(End of SysEx)

### ***Updating the Alpha Base OS via SD card***

**1.** Download the most recent file „AlphaBas.bin“ at <http://www.jomox.de/upload/updates/AlphaBas.bin> to your computer. You can also find the file in the product area of the website if you scroll down to the update files. Copy this file to the root directory of the SD card.

**2.** Insert the SD card to the AlphaBase. Press **(DISK)**.  
The display shows:

```
WAV found:254 Target:001
ABWV0001.raw___Load=Ent
```

**3.** Go right with the cursor until the display shows:

```
Load OS System File
AlphaBas.bin___Load=Ent
```

**4.** Now press **(Enter)**. The display shows:

```
Attention OS Update!
Are you sure? Load=Ent
```

**5.** Now press **(Enter)** again. The updating process starts and the system file gets copied to flash memory. During this process, you **MUST NOT** turn off the Alpha Base!  
After a few seconds the display reads:

```
Programing finished
Turn unit off and on
```

**6.** Now please turn the Alpha Base off and on again and see the new version number in the display.

That's it.

## Specifications

- 11 Instruments:  
Kick Drum, MBrane, Cl HiHat, Op HiHat, Clap, Rim Shot, Crash, Ride, X Sample 1, X Sample 2, FM Synth.
- Real analog Jomox kick drum.
- Real analog Jomox MBrane voice with 2 couple-able F-OSC for complex analog snare, percussion, bass and tom sounds ranging from 16Hz to 20kHz.
- 2 sample based instruments with analog VCA ADSR envelope and/or HH filter, optionally with metallic noise mixed as extra sound source. The HH filter is 2-pole, HP/LP/Res each separated parameters, peakable but not oscillating.
- 4 sample based instruments with analog VCA ADSR envelope and/or resonating multimode filter (LP, HP, BP) with ADSR envelope, optionally with metallic noise mixed as extra sound source. The multimode filter can be used as a signal generator in order to generate analog toms or sticks etc.
- 2 sample based instruments with external sampling input and pure digital playback.
- 1 FM synth with 4 operators and max. 6 voices for percussive sounds.
- Effects delay, reverb with send per instrument, also insertable into analog signal path on CH, OH, Clp, Rim, Ride.
- LFOs: per instrument one LFO (MBrane 2 LFOs) with 64 wave forms, each assignable on pitch, VCA, filter cutoff.
- 250 samples 16 Bit/48kHz in internal flash memory.
- SD card slot for loading of samples.
- USB (Midi Device).
- Midi In, Midi Out, Midi Thru.



## Version OS 1.2

- DIN sync out 2x integrated in the jacks Midi Out or Midi Thru.
- Inputs: stereo in for sampling, FX or sidechain. Both inputs are Hi-Z and suitable for guitar/bass or work up to line level +20dBu.
- Outputs: 8 individual balanced outputs, stereo mix balanced, headphones.
- Output Level: max. ca.+14dBu unbalanced, +20dBu balanced on all outputs.
- 18 encoders.
- Input Volume, Phones Volume and Mix Volume are analog potentiometers.
- LCD display 2x24 characters.
- 12V 2A DC external power supply.
- Stable metal case.
- Wood side cheeks, rubber feet.
- Size: 41cm (16.1") x 24cm (9.5") x 8cm (3.2") (back side).
- Weight: ca. 3.3kg (7.26 lbs).

Service, updates, tips and tricks

are available at:

JoMoX GmbH  
Ruhlsdorfer Str. 95 Geb. 101 Raum 304  
D-14532 Stahnsdorf  
Germany

email: [mail@jomox.de](mailto:mail@jomox.de)

[www.jomox.com](http://www.jomox.com)

We hope that you'd have lots of entertainment, joy and timeless awareness with our products.

Any feedback you might have is very welcome!

Cheers,  
Jürgen Michaelis

Berlin, 2017, 2018

Editors: Jürgen Michaelis, Carol McGuigan