

SG9040 GARDEN LIGHT



STANDARD SPECIFICATIONS

HOUSING

The sleek, modern styling is constructed entirely of die-cast aluminum.

LENS / DIFFUSER

UV stabilized polycarbonate panel covering LED array.
Premium materials won't yellow or crack.

LAMP PERFORMANCE – 5000K STANDARD

1.8W LED Array – 250Lm – 5000K – 85 CRI

L80 rating: 75,000 hrs

3000K – 6000K Color Temperature Option

Operating Ambient Temperature: -25°C – 65°C | -13°F – 149°F

32hrs Autonomous Operation – Automatic On/Off

Assured Operation When Installed In Direct Sun

POWER COLLECTION

3.5W Monocrystalline Solar Panel – 20.2% Efficiency

POWER STORAGE

6.4V LiFePO₄ Battery – 4.5Ah – 2,000 Cycle Rating

MOUNTING

Ground mount – 4-hole pattern accepts up to 3/8" bolts

FINISH

Available in various color options; polyester powder coat.

WARRANTY

Accompanied by 5 year limited warranty.

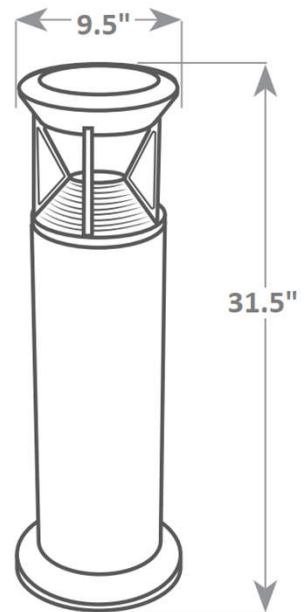

For ordering or questions please contact SELS USA at
704-495-3535 or CustomerService@SELSLED.com



SG9040 GARDEN LIGHT



OPTICAL ASSEMBLY DETAILS

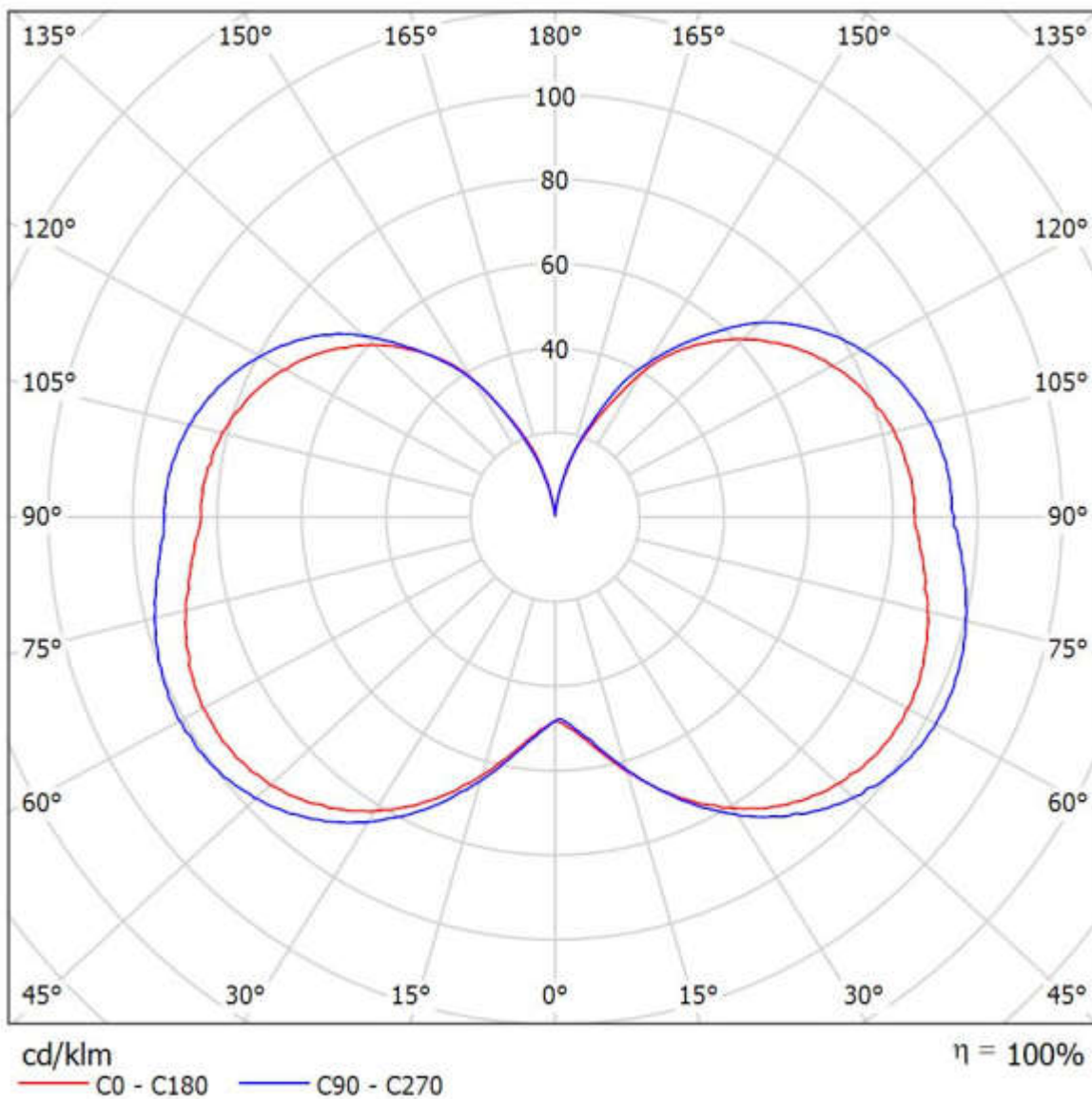

For ordering or questions please contact SELS USA at
704-495-3535 or CustomerService@SELSLED.com