

DOUBLE VISION® DUAL DISPLAY VOLTAGE INDICATING PHASER

and ACCESSORIES

Operating & Instruction Manual

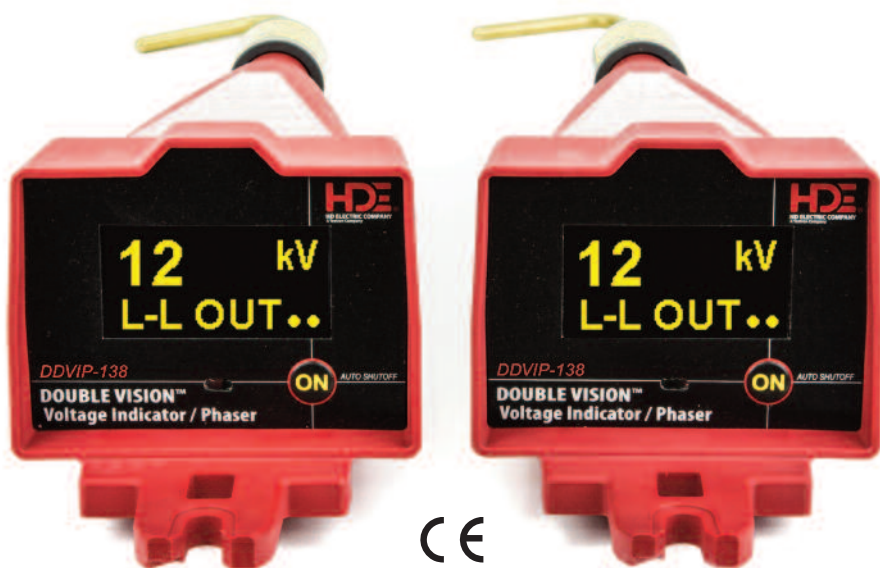

HDE HD ELECTRIC COMPANY

1475 Lakeside Drive • Waukegan, Illinois 60085 U.S.A. • 847.473.4980
fax 847.473.4981 • website: www.HDElectricCompany.com

DOUBLE VISION[®] DUAL DISPLAY VOLTAGE INDICATING PHASER *and ACCESSORIES*

- IMPORTANT SAFETY INFORMATION 4
- GENERAL DESCRIPTION 5
- TECHNICAL SPECIFICATIONS 6
- OPERATING INSTRUCTIONS 7-11
 - Pre-Use Inspection 8
 - Voltage and Phasing Measurements: Line-to-Ground 8
 - Voltage and Phasing Measurements: Line-to-Line 8-9
 - Test Point Measurements 10
 - Peak Hold 10
 - Accuracy Guidelines 11
- PROBES AND ACCESSORIES 12-13
 - Proof Tester[®] Voltage Indicating Phaser Tester 13
- CARE AND MAINTENANCE 13
- REPAIRS 13
- MAINTENANCE LOG 14
- LIMITED WARRANTY AND LIMITATION OF LIABILITY 16

IMPORTANT SAFETY INFORMATION

Read and understand these instructions prior to use. These operating instructions are not a substitute for proper training in the use of this equipment. High voltage systems present serious hazards, including the risk of death or serious injury due to arcing, thermal burns and electrocution. HD Electric Company products are intended solely for use by professionals with knowledge, training and experience in the use of the equipment and its accessories in and around high voltage systems.

All applicable federal, state, company and OSHA work practices must be followed. If you are unfamiliar with the work practices required, **DO NOT PROCEED**. Call HD Electric Company if you have any questions regarding this equipment.

THIS IMPORTANT LABEL IS AFFIXED TO THE PRODUCT. READ AND UNDERSTAND BEFORE PROCEEDING.

All tools require the use of accessory hot sticks, which may or may not be supplied with the tool. The minimum hot stick length required for safe use depends upon the particular operation; consult federal, state, company and OSHA specifications for the proper hot stick length for the intended operation.

The users of this tool should always be equipped with personal protective equipment including high voltage gloves, flame retardant clothing, eye and face protection. Some applications may require additional protective equipment.

Accessory probes are available for all tools. Always use the proper probe(s) for your application.

Failure to follow these and other warnings and safety precautions may result in severe injury or death.

OPERATIONAL IMPAIRMENT

If the DDVIP-138 is used in a manner not described in this instruction manual, the protection and effective operation of this equipment may be impaired.

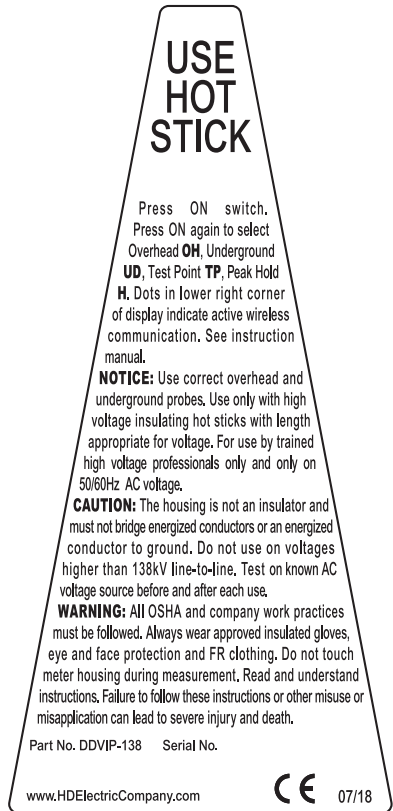

GENERAL DESCRIPTION

The HD Electric Dual Display Voltage Indicating Phaser includes a pair of single stick line-to-ground voltage indicators that communicate with each other wirelessly. Both units are constructed with high strength molded housings, epoxy encapsulated high voltage resistors and a digital LED display.



Never allow another high voltage or grounded conductor to contact the instrument during use. Keep the DDVIP-138 housing free and clear of all structures at all times. Bridging the DDVIP-138 probe or housing from line-to-ground or line-to-line may cause a fault and arc.



**Hot Stick Connection:
Shotgun or Universal Spline**

TECHNICAL SPECIFICATIONS

MODEL NUMBER: DDVIP-138

ENVIRONMENTAL CONDITIONS

- Conditions - Indoor and outdoor use
- Altitude - Up to 6,566 ft. (2000M)
- Operating Temperature -20°F to +120°F (-29°C to +49°C)
- Humidity - 95% to 49°C (non-condensing)
- Pollution Degree - PD4
- Measurement Category IV – Classification Rating (CAT IV) – Product is intended for use with test and measuring circuits connected to the circuits/wiring outside of a building installation, including transmission lines.
- Overvoltage Category IV
- Enclosure Material - Supertough Nylon UL 94-HB
- Printed Circuit Boards - FR-4 UL94V-0
- IEC Protection Rating - IP64

DIMENSIONS:

- Length 14 in. (36cm), Width 4.6 in. (12cm), Height 4.1 in. (10cm)
- Weight - (w/o probes): 1.6 lbs. (0.7kg) each unit
- Battery Life - 8 hours continuous use under normal operating conditions
- Battery - 9V alkaline 1604A, IEC 6LR61 or 9V lithium, ANSI-1604LC
- Digital Meter - Reads in kilovolts
- Voltage Range - 100V-80kV each unit line-to-ground and
100V-138kV line-to-line
- Frequency - 50/60Hz
- Auto-Ranging - No range selector switch
- Accuracy - Within 15% of reading, dependent upon geometry
- Meter Resolution: 0.10 - 0.90 range with 10 Volt resolution
1.0 - 9.9 range with 100 Volt resolution
10 - 80 range with 1,000 Volt resolution

OPERATING INSTRUCTIONS

The DDVIP-138 Dual Display Voltage Indicating Phaser measures 50Hz and 60Hz AC RMS voltage from 100V to 80kV line-to-ground and 100V to 138kV line-to-line. The frequency is determined automatically.

Press the ON button on both units to turn them on. The initial zero kV indication will be replaced shortly with the display of hollow zeros as a battery saving measure.

Pressing the ON button again will cycle through the available measurement modes: overhead direct contact (OH), underground direct contact (UD), capacitive test point (TP) and peak hold (H). Selecting Underground mode when working with pad mounted equipment allows the tool to adjust the displayed voltage for optimal accuracy.

A low battery indication in the lower right corner of the screen indicates that the battery will need to be replaced soon. If the battery dies completely, the display will shut off. The battery compartments are on the bottom of each unit. HD Electric recommends using 9V lithium batteries but alkaline batteries may also be used.

Both displays will turn off after five minutes of a zero display.

BATTERY REPLACEMENT INSTRUCTIONS

To replace the battery, open and remove the compartment on the bottom of the housings. Remove and dispose of the old battery, replacing each with a fresh, new 9-volt lithium or alkaline battery.

Note battery polarity on the battery compartment. This compartment cannot be reinserted if the battery polarity is reversed.



OPERATING INSTRUCTIONS *continued*

Pre-Use Inspection

WARNING: Before using the instrument be sure to test and inspect the equipment to ensure that it is functioning properly and is in safe, working condition. Failure to do so may cause serious injury or death and may result in erroneous test measurements.

Before making any high voltage measurements, test and inspect the tool as follows:

- 1) Make certain the instrument is clean and dry.
- 2) Be sure that you are using hot sticks of the appropriate length, and examine each hot stick to ensure that it is clean, dry and waxed to a clear shiny surface.
- 3) Attach the appropriate probes for overhead or underground applications (see page 12) and ensure that the probes are properly installed and tightened (do not overtighten).
- 4) Confirm that the tool is configured for the correct application (normal reading, Peak Hold, Test Point).
- 5) Test each indicator with an indicator tester such as the HD Electric PT-DDVIP Proof Tester® Voltage Indicator Tester (see page 13).

Voltage and Phasing Measurements – Line-to-Ground

Press the ON button to select the appropriate overhead (OH) or underground (UD) mode. Maintain contact with the probe tip only long enough to read the display. Line-to-ground voltage measurement will be shown on the display. The letters "L-G" will indicate that the tool is displaying a line-to-ground voltage. Always keep the tool housing free and clear of energized phases and conductors.

Voltage and Phasing Measurements – Line-to-Line

We recommend that two person crews perform all line-to-line voltage measurements and phasing operations. The letters "L-L" will indicate that the meter is displaying a line-to-line voltage. Since the operation is occurring near two energized conductors, the use of two person crews allows each person to operate one stick and maintain high safety standards.

In order to make line-to-line measurements, each DDVIP-138 must contact an energized line. Be sure that only those probes intended for the particular application are used (see page 12). Always keep the housing free and clear of energized phases and conductors. For phasing applications, the tools will be placed on opposite sides of an open point, typically a switch. The phasing operation will indicate if two sides of a line are in-phase before closing a switch. If the two phases are out of phase, the tool will indicate "OUT" below the voltage reading.

To check all phases, proceed as follows:

- 1) Check voltage on each phase from line-to-ground to verify all phases are live and at the same voltage.
- 2) Place one of the probes on a conductor on one side of the switch.
- 3) Place the other probe on one of the three phases on the other side of the switch.
- 4) If the conductors are out-of-phase, the tool will read line-to-line voltage. If they are in-phase, the tool will read near zero but may read up to 15% of the line-to-line voltage.
- 5) Continue this procedure with all three phases on both sides of the switch.

If an intermediate reading is found, the phasing cannot be determined by this method and the switch should not be closed until other means are used for phasing.



When the tools are first applied to voltage, they both indicate line-to-ground voltage. This is indicated in the displays by L-G.



Once one tool is applied to line to ground voltage, it begins to wirelessly search for a second meter. Any DDVIP-138 may connect with any other DDVIP-138 applied to voltage in the area. When two meters have established wireless communication, moving dots will appear in the bottom right corner of each display.

After a few seconds, both tools will show line-to-line voltage, indicated in the displays by L-L.



If they are out of phase, both tools will display the word L-L OUT beneath the voltage reading.



If the two tools are in phase, the line-to-line voltage will be near zero and both tools will show L-L IN underneath the voltage reading.



OPERATING INSTRUCTIONS *continued*

Overhead Mode Setting

This is the default mode for voltage measurements and appears when the meter is first turned on. OH mode should be used for all overhead voltage measurements or any other application where the meter is not close to any grounded surfaces.



Underground Mode Setting

Underground mode should be selected when the meter is used in or on any pad mounted transformers or switchgear or anywhere the DDVIP-138 will be used in close proximity to grounded surfaces such as equipment enclosures. Selecting UD mode improves meter accuracy in these environments.



Test Point Measurements

To activate Test Point mode simply push the ON button again. Test Point mode is indicated by TP in the display. To turn Test Point mode off, simply push the ON button again to continue cycling through functional modes. When using a DDVIP-138 to phase between test points, the important measurement is whether high voltage is present or not. The proper procedure for phasing between elbow test points is as follows:



- 1) Both elbows must be energized. Follow the proper safety practices for removing the test point protective caps and exposing the live test points. Treat all exposed electrodes as energized high voltage. Measure from both elbow test points to ground. These measurements should show that both elbows are energized and, if both elbows are of the same type and manufacture, should measure the same approximate line voltage.
- 2) Measure from one elbow test point to the other. This reading will show either a high voltage reading indicating the elbows are out-of-phase or a zero or low voltage reading indicating the elbows are connected to the same phase. The in-phase voltage measurement can be between zero and 15% of the nominal line-to-ground voltage. If both elbows are of different type and manufacture, then the reading may be higher.

Peak Hold

Press the ON button to activate this feature and once again to clear the reading. The H in the display confirms Peak Hold. The display will hold the highest reading while Peak Hold is activated. **NOTE:** The tools will not shut off while a peak reading is displayed.



OPERATING INSTRUCTIONS *continued*

Accuracy Guidelines

Best overall accuracy is with a single energized conductor (Fig. 1), midspan with no nearby grounds.

Expected accuracy is +/- 3%.

In a typical overhead three phase system with horizontal spacing, the best accuracy is on the two outside conductors (Fig. 2).

Expected measurement accuracy on the two outside conductors is +/- 5%

On the center conductor, expected accuracy is +/- 10%.

In more complex situations with transmission or other higher voltage overbuild, accessory hardware such as fuses or disconnects or for measurements made on points such as terminations or endpoints, best accuracy is with the DDVIP-138 as far away as possible from other live conductors or grounds, away from points or corners and facing the ground (Fig. 3 & 4).

Expected overall accuracy is +/- 25%.

For measurements made on grounded conductors, keep the DDVIP-138 as far away as possible from energized conductors and face the DDVIP-138 towards ground (Fig. 5).

Readings on grounded conductors with nearby energized conductors may indicate 0.1 to 0.2kV or more.

For best accuracy with readings on pad mount equipment, livefront (shown) or deadfront, keep the DDVIP-138 housing clear of adjacent grounds (Fig. 6).

Expected overall accuracy is +/- 10%.

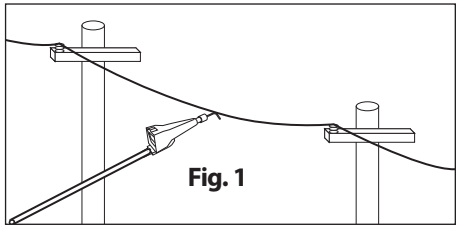

Fig. 1

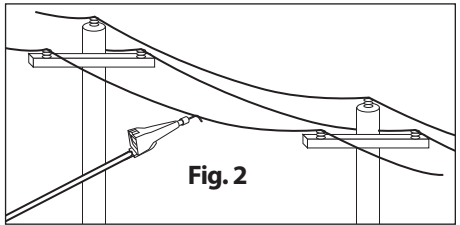

Fig. 2

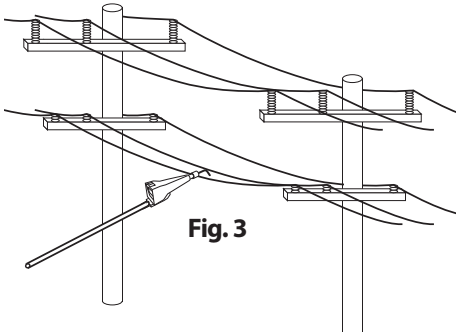

Fig. 3

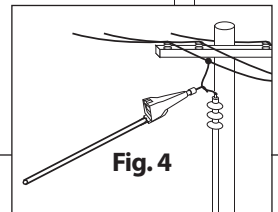

Fig. 4

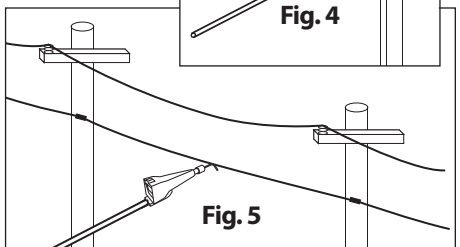

Fig. 5

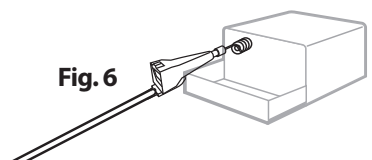

Fig. 6

PROBES AND ACCESSORIES

WARNING: ALWAYS use probes appropriate to your application. NEVER use overhead probes in underground applications. Failure to use the correct probe can result in arcing or electrical contact and may cause serious injury or death. If you are not trained in the particular operation or are not sure about the appropriate probe for your application **DO NOT PROCEED**.

Overhead Probes

- A. 025-OLPS-5 brass hook probe
- B. 025-OLPS-6 brass pigtail probe

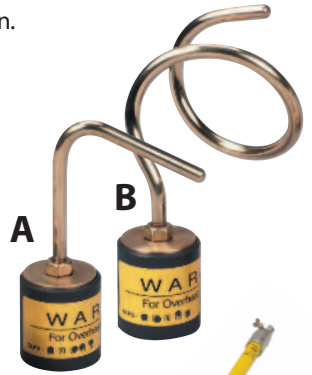

C. Hot Stick

A range of hot sticks are available in lengths starting at 4'. Contact HD Electric for more details.

D. Insulated Underground Probe

GCP-1 for general underground use on grounded terminals, exposed high voltage terminals or elbow test points.

Underground Dead Front Bushing Probes

- E. ASP-15/25 for use in 15kV and 25kV loadbreak bushings
- F. ASP-35U for use in 35kV loadbreak bushings

G. Underground Elbow Probe

EA-15/25 for insertion in loadbreak elbows.

NOTE: The elbow must be firmly supported when using this probe.



PROBES AND ACCESSORIES *continued*

PT-DDVIP Tester for DDVIP-138

The PT-DDVIP Proof Tester® Voltage Indicating Phasor Tester is for use only on the DDVIP-138. This tester generates high voltage AC for testing the DDVIP-138.

To use, apply the metal plate on the bottom of the Proof Tester to the metal probe on the end of the DDVIP-138 housing. Press and hold the TEST button on the Proof Tester. A properly operating DDVIP-138 will display voltage of approximately 1–3kV. If the Proof Tester LED does not light, replace the Proof Tester battery with a 9V lithium or alkaline type battery. Perform the same steps on both DDVIP-138 tools.



CAUTION: This device generates high voltage AC. There is no danger of electric shock when this Tester is used as directed. Discontinue use and return to HD Electric Company for service if the housing is cracked or broken, or if the battery cover is lost.

WARNING: Do not use this tester except as directed. Do not use to test equipment other than the DDVIP-138. Do not apply to energized circuits or equipment. Do not operate this tester without the battery cover and do not open the housing. Refer all servicing to the factory. Failure to follow these instructions may lead to electric shock, severe injury or death.

Proof Tester® for HD Electric DDVIP

This tester tests DDVIP Voltage Indicators/Wireless Phasers. To use, apply the tip of the DDVIP to the metal end plate on the Tester. Press and hold the Test button on the Tester. A properly operating DDVIP will indicate a voltage of about 1–3kV. If the DDVIP does not indicate, return to factory for service. See instructions. If the Tester LED does not light, replace the Tester battery with a 9V alkaline or lithium type.

CAUTION: This device generates 340VAC for testing the DDVIP voltage indicator. There is no danger of electric shock when this tester is used as directed. Discontinue use and return to HD Electric Company for service if the housing is cracked or broken or if the battery cover is lost.

WARNING: Do not use this tester except as directed. Do not use to test equipment other than the DDVIP. Do not apply to energized circuits or equipment. Do not operate this Tester without the battery cover and do not open the housing. Refer all servicing to the factory. Failure to follow these instructions may lead to electric shock, severe injury or death.

HD Electric Company
www.HDElectricCompany.com



PT-DDVIP 7/18

CARE AND MAINTENANCE

Periodic regular maintenance is required to keep the voltage indicating phasers in proper operating condition. Digital models will require periodic battery replacement. Keep the voltage indicating phasers clean and dry and always store it in its case. The sticks should be kept clean and free of dirt, contamination and marking. Although we do not specify a calibration cycle, we recommend you test and measure your instrument annually. The Maintenance Log provided can be used to record these events. Contact HD Electric Company for details.

CLEANING INSTRUCTIONS

To clean the DDVIP-138 wipe with a damp cloth with water. Do not use harsh chemicals or solvents.

REPAIRS

All repairs and calibration are performed at HD Electric Company. If any damage is found please contact HD Electric Company at 847-473-4980 to arrange for service.

MANUFACTURING LOCATION – HD Electric Company • Waukegan, IL. 60085, USA

LIMITED WARRANTY AND LIMITATION OF LIABILITY

This warranty applies to all products sold by HD Electric Company (the "Products"); provided, however, that the term Products does not include any third party products purchased through HD Electric Company, for which no warranties are made (the "Third Party Products"). Third Party Products may be subject to a separate manufacturer's warranty; [should you have any question regarding whether a separate warranty applies, please contact HD Electric Company].

NOTICE: READ THIS LIMITATION OF WARRANTY AND LIABILITY BEFORE BUYING OR USING THE PRODUCTS CONTAINED HEREIN.

It is impossible to eliminate all risks associated with the use of the Products. Risks of serious injury or death, including risks associated with electrocution, arcing and thermal burns, are inherent in work in and around energized electrical systems. Such risks arise from the wide variety of electrical systems and equipment to which Products may be applied, the manner of use or application, weather and environmental conditions or other unknown factors, all of which are beyond the control of HD Electric Company.

HD Electric Company does not agree to be an insurer of these risks, and shall have no liability for any claims arising from such risks.

WHEN YOU BUY OR USE THESE PRODUCTS, YOU AGREE TO ACCEPT THESE RISKS.

HD Electric Company warrants to the original purchaser that the Products (excluding any third party products purchased through HD Electric Company, for which no warranties are made) will be free from defects in material and workmanship, under normal use and regular service, and preventative maintenance for a period of one (1) year (ten (10) years for HDE Capacitor Controls) from the date of shipment (the "Warranty Period"). Should any failure to conform with this warranty be found during the Warranty Period, you must notify HD Electric Company of your claim within thirty (30) days of discovery, and within the Warranty Period. Your failure to give notice of claims of breach of warranty within the Warranty Period shall be deemed an absolute and unconditional waiver of claims for such defects. HD Electric Company will have no responsibility to honor claims received after the date the applicable Warranty Period expires.

Upon notice of your claim, HD Electric Company will provide a return authorization number, and further instructions on how to return the product for service. You must follow HD Electric Company's instruction. You are responsible for all Product removal, handling, re-installation, and shipping (both to and from HD Electric Company). Products returned for repair, as well as repaired or replacement Products shall be sent postage / freight prepaid. After receipt of a product which HD Electric Company determines is defective, HD Electric will, at its option, either (1) repair (or authorize the repair of) the Product or (2) replace the Product, subject to the following: The Products are made using parts sourced from a variety of manufacturers. Due to the rapidly changing technology environment, parts may become obsolete / unavailable over time (end of life). In the event that a Product cannot be repaired or replaced due to unavailability of parts, HD Electric Company will use commercially reasonable efforts to obtain substitute parts or conduct work around design, but cannot guarantee its ability to do so.

Items not found defective will be returned at your expense, or failing receipt of instruction from you on return of such items within five (5) business days of our notice to you that the product is not defective, HD Electric may dispose of the product at its discretion and with no liability to you. HD Electric Company's determination of defects is final. Products repaired or replaced during the Warranty Period shall be covered by the foregoing warranties for the remainder of the original Warranty Period or ninety (90) days from the date of delivery of the repaired or replaced Products, whichever is longer.

LIMITATIONS:

This warranty is void in the event of misuse, alteration, faulty installation, or misapplication of the product.

This warranty does not cover failure of product or components due to any ACT OF NATURE; lightning, floods, hurricanes, tornadoes or any other such catastrophic events.

HD Electric Company does not warrant any third party products or associated hardware or their performance or suitability for use and application. Such items are provided "as-is".

All repairs must be authorized by HD Electric Company. Unauthorized repairs will not be reimbursed under any circumstances.

HD Electric Company is not required to make replacement or loaner equipment available while Products are being repaired or replaced, or to compensate you for any in/out labor charges or expenses associated with removal, handling or re-installation of the Products.

TO THE MAXIMUM EXTENT PERMITTED BY LAW, THIS WARRANTY AND THE REMEDIES SET FORTH ABOVE ARE EXCLUSIVE AND IN LIEU OF ALL OTHER WARRANTIES, REMEDIES AND CONDITIONS, WHETHER ORAL OR WRITTEN, EXPRESS OR IMPLIED. HD ELECTRIC EXPRESSLY DISCLAIMS ALL OTHER WARRANTIES OF ANY KIND, EXPRESS OR IMPLIED, INCLUDING WITHOUT LIMITATION IMPLIED WARRANTIES OF FITNESS FOR A PARTICULAR PURPOSE, MERCHANTABILITY AND NON-INFRINGEMENT.

IN NO EVENT SHALL HD ELECTRIC COMPANY BE LIABLE FOR ANY INDIRECT, INCIDENTAL, CONSEQUENTIAL OR SPECIAL DAMAGES RESULTING FROM THE USE OR HANDLING OF THESE PRODUCTS. THIS SHALL INCLUDE BUT, NOT LIMITED TO, LOST PROFITS OR REVENUE, LOSS OF USE OF THE PRODUCTS, COST OF SUBSTITUTE PRODUCTS, FACILITIES OR SERVICES, OR DOWNTIME.

IN NO EVENT SHALL HD ELECTRIC COMPANY HAVE ANY LIABILITY FOR ANY THIRD PARTY PRODUCTS OR ASSOCIATED HARDWARE, OR CUSTOMER-OWNED SYSTEMS, EQUIPMENT OR SOFTWARE.

HD Electric Company must have prompt notice of any claim so that an immediate product inspection and investigation can be made. Buyer and all users shall promptly notify HD Electric Company of any claims, whether based on contract, negligence, strict liability, or other tort or otherwise be barred from any remedy.

HD Electric Company is committed to ongoing review and improvement of its product lines, and thus reserves the right to modify product design and specifications without notice.

HD Electric Company® products are available through HDE® sales representatives worldwide.