

# NEWPORT ULTRA

AIR PURIFIER

---

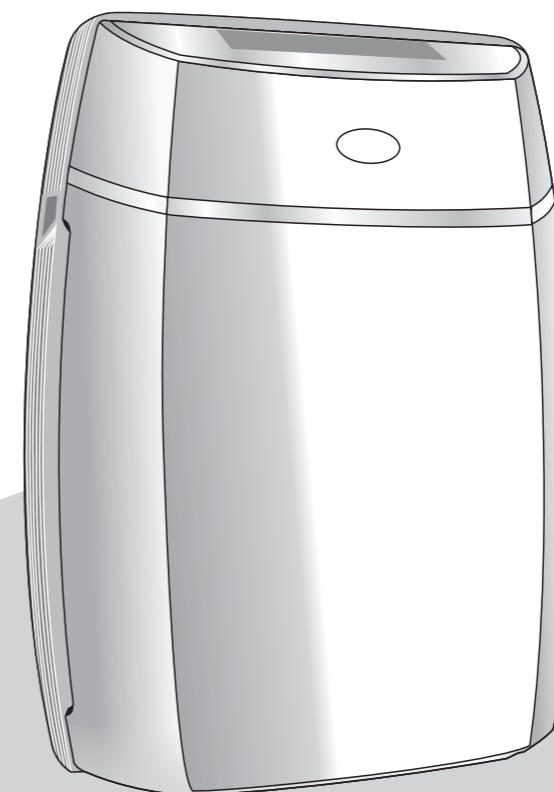

## Real Spirit USA, Inc.

320 South Rock Blvd. Ste. 210  
Reno, Nevada 89502  
Tel: 1-888-698-2080  
Website: [www.AdvancedPureAir.com](http://www.AdvancedPureAir.com)  
Info@AdvancedPureAir.com

Thank you very much for choosing this appliance.  
Please read the operating instructions carefully before using  
and retain in a safe place for later reference.

Instructions For Use

**PURE  
CONTROL**

# NEWPORT ULTRA

## AIR PURIFIER

---

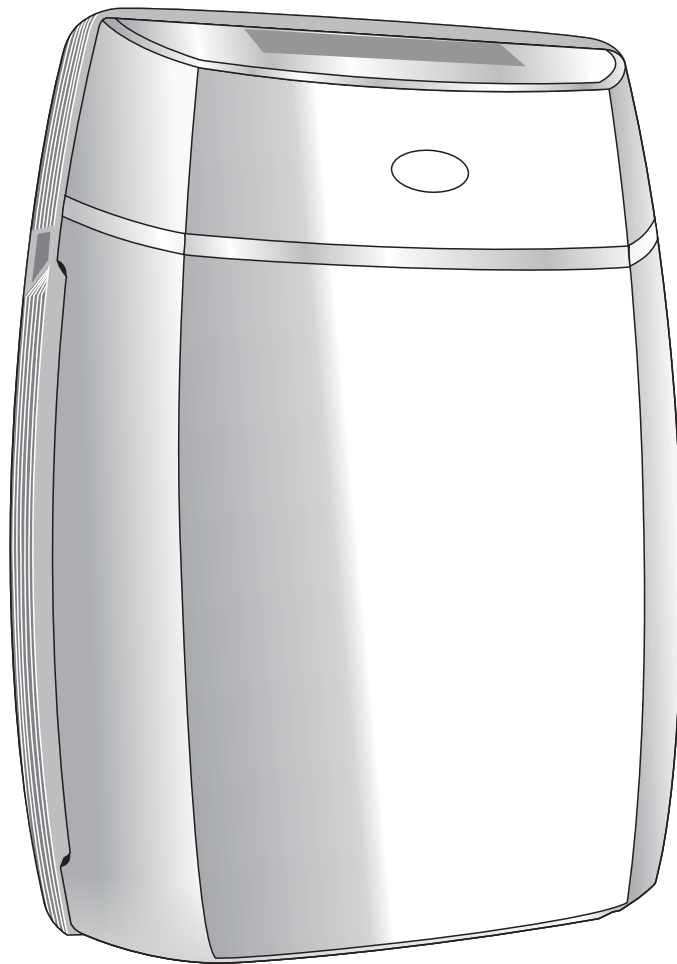

Thank you very much for choosing this appliance.  
Please read the operating instructions carefully before using  
and retain in a safe place for later reference.

Instructions For Use

**PURE  
CONTROL**



# SAFETY OPERATION

Please exercise caution when using this air purifier or any other electrical device! This manual describes the safety precautions which should be observed in relation to your air purifier. Please review carefully BEFORE using this product.

## ⚠ CAUTION



RATED VOLTAGE

The voltage rating for air purifiers sold in the USA, Japan and Canada is AC100-120V, 50/60Hz and in Europe is AC 230V, 50Hz. Using the wrong current may result in unit damage, electrical shock or fire.



KEEP AWAY FROM WATER

To prevent the possibility of electrical shock or short-circuiting your air purifier, Do NOT place the unit in or near the shower, bathtub or other places where water seep into and damage the unit.



DO NOT DISMANTLE

Do NOT attempt to dismantle, repair or modify this device on your own. Doing so could result in electrical shock or damage to the unit. In the event of malfunction, contact an authorized maintenance facility.



DO NOT COVER

Do NOT operate your air purifier while it's covered with fabric, plastic or other materials. This can obstruct air flow, damage the unit and may pose a fire hazard.



AVOID HEAT SOURCES

Do NOT operate your air purifier in places where flammable, explosive or otherwise combustible materials are stored.



DO NOT DISTORTION

To avoid distortion or interference, your air purifier should be placed at least three (3) feet from computers, televisions and radios.



AVOID DIRECT SUNLIGHT

Do NOT place the unit in direct sunlight or near lit fireplaces, furnaces, ovens or other high temperature objects. Doing so can damage the air purifier and may pose a fire hazard. Avoid operating the unit when the air temperature exceeds 104 F/40 C.



DAMAGED CORD

If the electric cord is damaged in any way, it must be replaced by the manufacturer or a qualified service center. NEVER operate a unit with a damaged electric cord. Doing so presents a serious risk of fire and/or electrical shock.



DO NOT TAMPER

Do NOT place foreign objects in air purifier which can damage the unit or result in electrical shock. To avoid machine damage, injury and accidents, Do Not allow children to touch or play with this device.



WHEN TO UNPLUG

For safety reason and to avoid the risk of electrical shock and/or fire, unplug your air purifier from the electrical outlet under each of the following conditions

- When cleaning or servicing the air purifier or replacing filters.
- When you will not be using your air purifier for an extended time period.
- When moving the unit from one location to another.

## Features

- High performance DC fan, low energy consumption, durable use
- Built-in smart gas and dust sensor, automatic sensing and adjust airflow speed
- Sleep mode, quite and comforting
- Dust collector cell, easy to clean, never needs to be replaced
- Multiple air inlets design effective in purification coverage
- Large volumes of air rapidly circulate and purify air
- Convenient remote control, six operating modes for easy control
- High performance filter effectively removes PM2.5 and extra fine particles of 0.1 – 0.3 microns
- Excellent dust removal rate up to 99.97%
- Effectively eliminate odor and smoke to freshen the air
- High-power UV LED and catalyst technology effectively sterilize and kill bacteria

# DESCRIPTION OF THE APPLIANCE

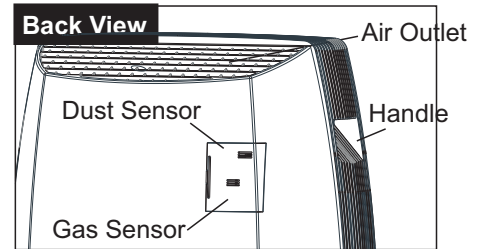
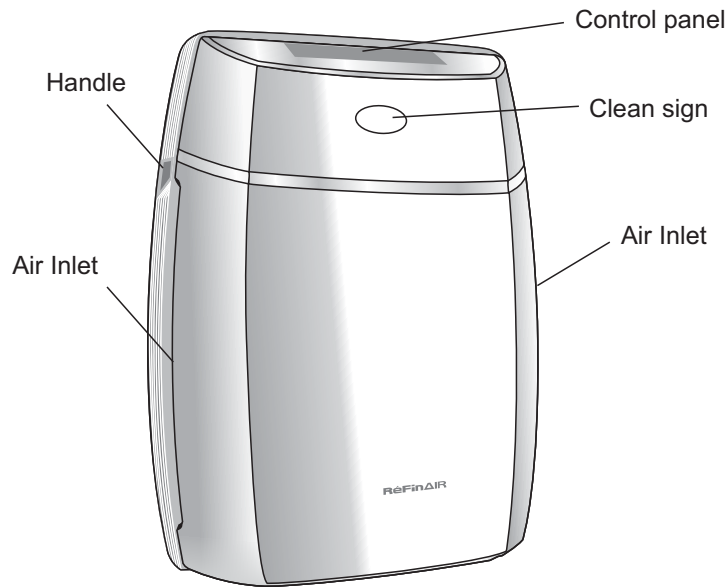

## MAJOR COMPONENTS

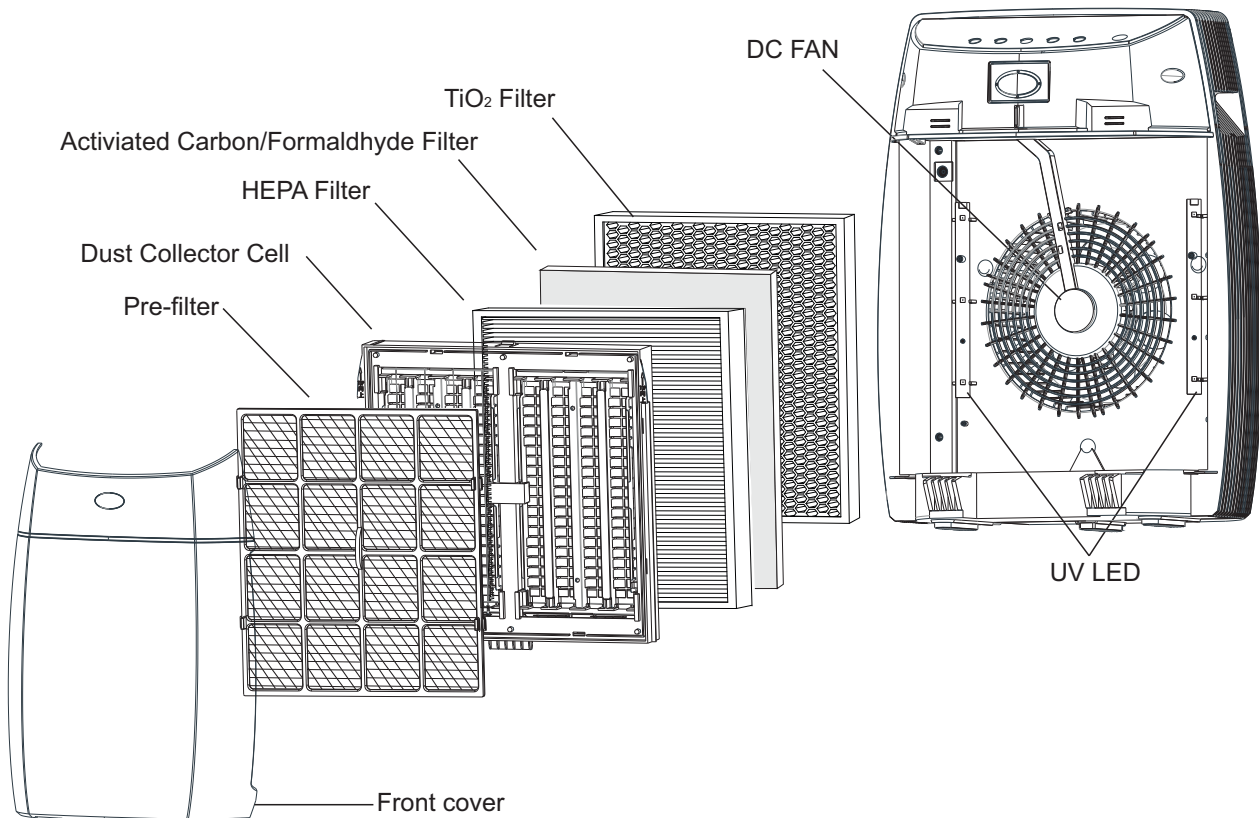

# PREPARATIONS BEFORE USE

## ACCESSORY LIST

Please check all the accessories are available before operating

Owner's Manual

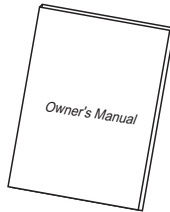

Pre-filter

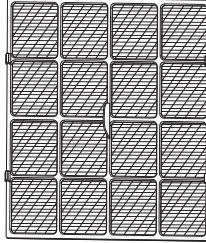

Dust Collector Cell

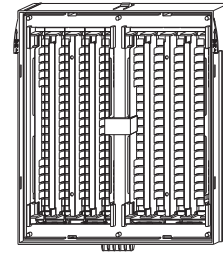

HEPA Filter

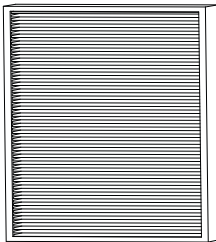

Activated Carbon/Formaldehyde Filter

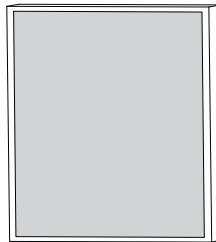

TiO<sub>2</sub> Filter

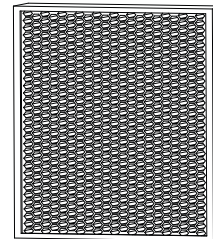

## USES OF FILTERS

For initial use or filter replacement, please remove the plastic bag of filter. If the plastic bag is not removed, the unit may operate noisily.

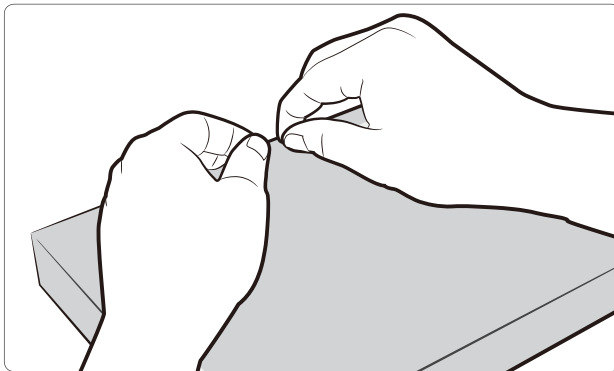

- The purifying efficiency will decrease if the air purifier operates without filters.
- For initial use, new filters may emit a little smell; the smell will dissipate naturally after operating for more than one day.
- Please close the windows or door in the area during operation. For long time use, please ventilate periodically.
- If the smell is heavy in the area (such as cooking), please ventilate the area and then remove the rest of smell by unit. Otherwise, the purifying efficiency may decrease and the life span of activated carbon filter will reduce.

# PREPARATIONS BEFORE USE

## Operation

- Locate the unit on a solid surface. Be sure the air inlet/outlet is not blocked by other objects. (At least 30cm clearance on the sides)  
It is best to locate the unit where it will be out of any children's play area.
- Before plugging in the unit, please open the windows in the area where you will be using the unit. Ventilate the area for 2-3 hours if possible. Once the area has been ventilated, close the windows and plug in the unit.(Figure 1)
- Switch on the unit and start to operate under AUTO mode.
- ❗ Once started, the color of CLEAN SIGN will change alternately for 1 minute (as it memorizes the existing fresh air condition), and then CLEAN SIGN will indicate current air quality. (Figure 2)  
After plugging in, the unit sensor will sample the air and retain a memory of the existing indoor air condition. (The existing indoor air condition will be input as "Clean Air").  
Note: Whenever the unit is unplugged, all memorized content will be erased.

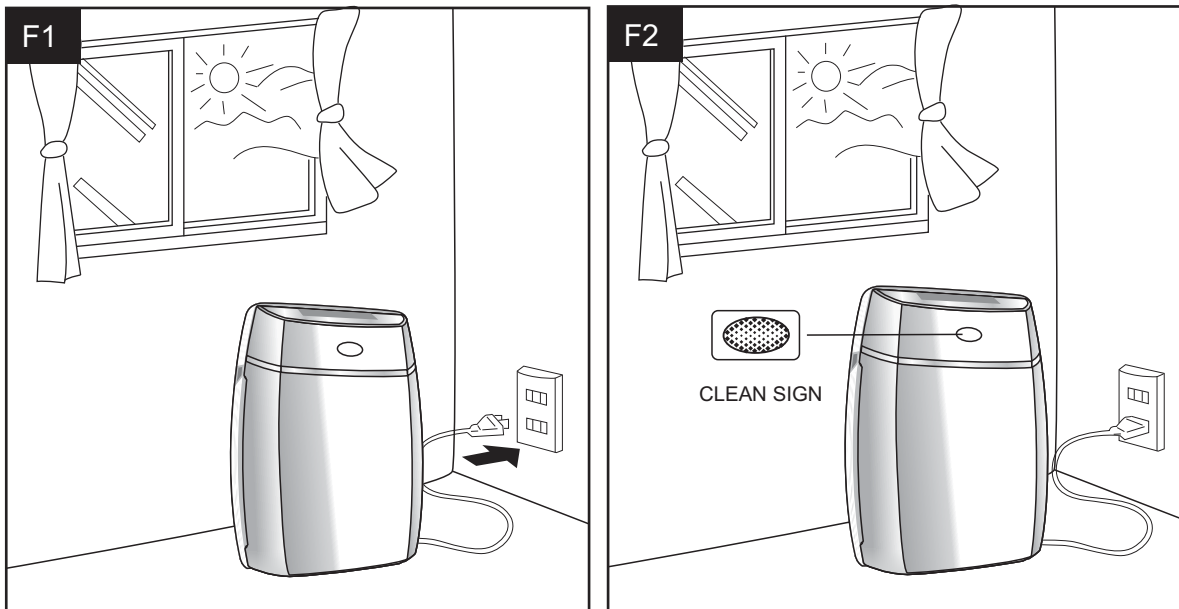

### ⚠ Caution

- For initial use or re-operate the unit after unplug, the sensor need to be pre-heated for 3-5 minutes and will not response during this period.
- Besides, if the current air quality is not good (such as smoke, cosmetics or alcohol is presented), please ventilate and freshen the air before closing windows.
- Re-operate the unit after long period unused, the sensitivity of the sensor may decrease, it will revert to normal after 1-2 days operation.

# INSTRUCTIONS FOR OPERATING

## Control Panel Instructions

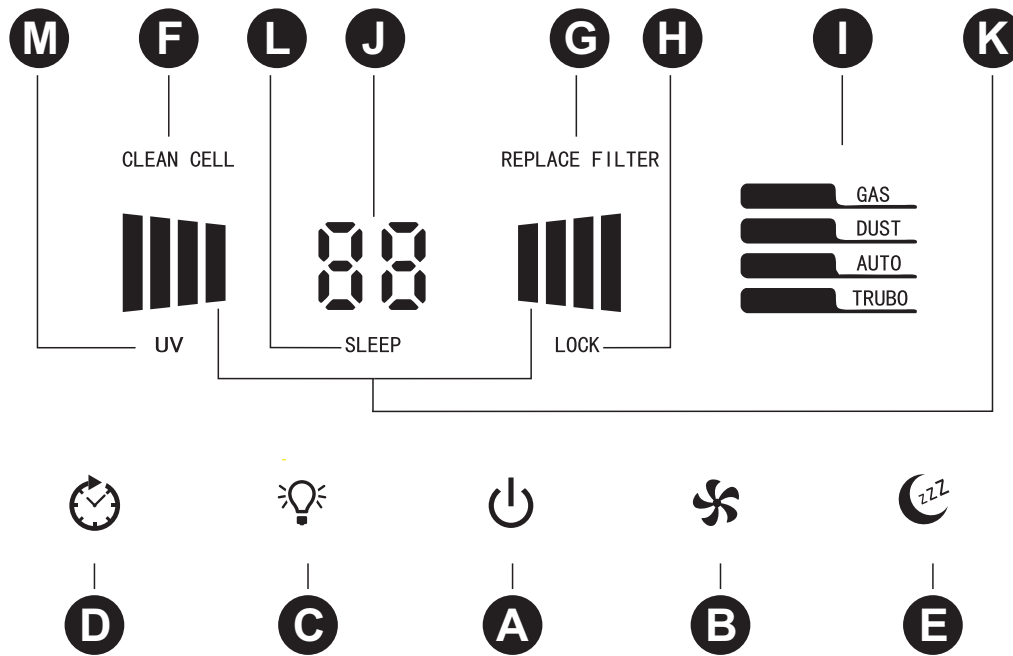

### A) On/Off Button

By pressing button A  once, you can switch the unit on, display screen will illuminate. The appliance will start to operate under AUTO mode. By pressing it twice, the unit is switched off.

### B) Fan Modes

This unit has six different fan modes to choose from. Please choose a proper level of circulation according to the indoor air quality and room size. By repeated pressing button B , the fan mode will change according to following sequence. Symbol K shows which of the six modes you have selected.



Under automatic operation, unit will automatically switches to the proper fan modes according to the level of pollution in the air as detected by the sensor. As the air is purified, the unit will automatically switch back to silent mode. Additionally 4 stages of clean sign, clearly shows your current air condition accordingly:

Green: Clean

Light Orange: Low pollution

Orange: Medium pollution

Red: High pollution





# INSTRUCTIONS FOR OPERATING



## C) Operation with photocatalyst(TiO<sub>2</sub>)

Button C  is used for switching the photocatalyst on and off (Symbol “UV” lights up). This appliance combines advanced photocatalyst technologies to reduce odors and chemical fumes from glues, solvents, and synthetic materials when air passes through the filter and is activated by the internal UV LED. If turned off, the appliance will continue to filter particles from the air that passes through the filter but its odor and VOC capability will be greatly reduced.



## D) Timer

Using button D  the operation time can be set adjustable between 1~9 hours or continuous operation (circulated ) , Symbol J shows the operating period that has been set (1h/2h/3h/4h /5h/6h/7h/8h/9h/ circulated ). The display will automatically show the current value after a few seconds.

## E) Sleep mode

By pressing the button E  once, the sleep mode is switched on which automatically dims the display brightness, appliance continue to operate with silence technology. If button E  pressed again, the appliance will no longer be in sleep mode.



## F) Cleaning indicator

If red “CLEAN CELL” indicator appears on the display, the appliance should be cleaned as recommended by the manufacturer. When the dust collector cell is re-installed after cleaning, switch on the appliance and keep pressing the button E  and D  at least 3 seconds until buzzer beeps, “CLEAN CELL” indicator goes out and “CLEAN CELL” timer is reset.

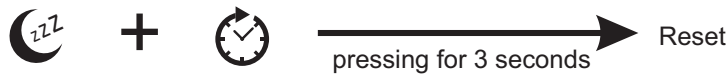
Reset buttons



## G) Replace indicator



If red “REPLACE FILTER” indicator appears on the display, the filters (HEPA/Activated carbon/Formaldehyde) should be replaced as recommended by the manufacturer. When the filters are re-installed after replacement, switch on the appliance and keep pressing the button E  and B  at least 3 seconds until buzzer beeps, “REPLACE FILTER” indicator goes out and “REPLACE FILTER” timer is reset.

Reset buttons



# INSTRUCTIONS FOR OPERATING

## H) Child lock

By pressing button E  and A  for 3 seconds until buzzer beeps, Symbol "LOCK" appears on the display, child lock function is activated to prevent incorrect operation by children, all buttons are not able to operate. Repeat above step to unlock.

### Lock/Unlock Buttons



## I) Sensor indicator

Once the sensors detect gas or dust pass through the unit, Symbol "GAS" or "DUST" illuminates on the display.

## Remote control

The operations of remote control please refer to control panel instructions.

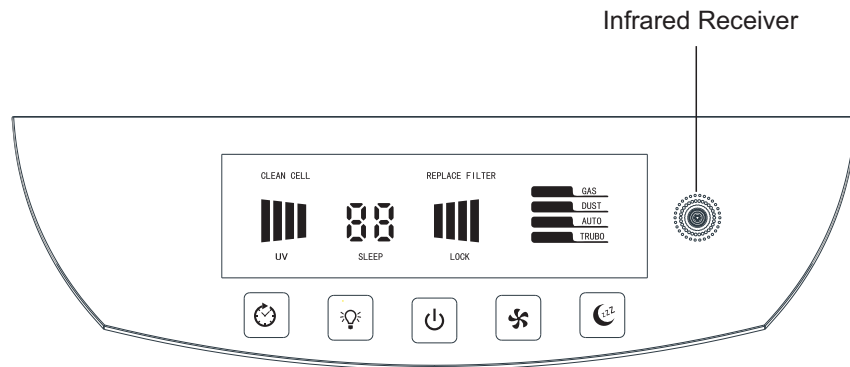
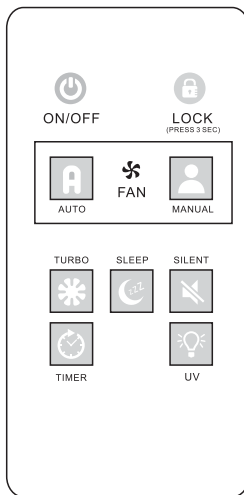

# CLEANING AND MAINTENANCE

 Cleaning the unit while it is plugged in may result in electric shock, electric spark and serious injury. Unplug the unit before cleaning or maintenance.

## Disassembling the Air Purifier

- After unplugging, disassemble the unit in sequence of 1 to 5 as shown below. (Put the unit back together in the reverse 5 to 1 sequence.)

### 1 Remove the Front Cover

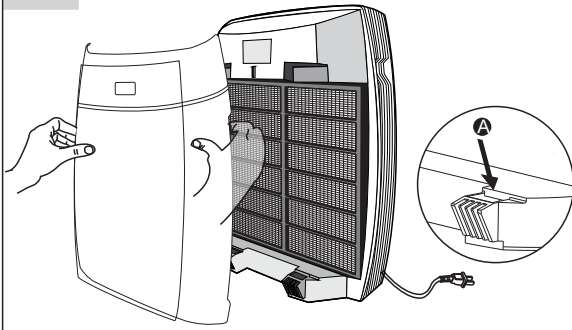

Press the front cover by thumbs and gently pull forward the front cover.

#### When assembling

1. Insert into Position A
2. Firmly reconnect the front cover back to its original position

### 2 Remove the dust collector cell

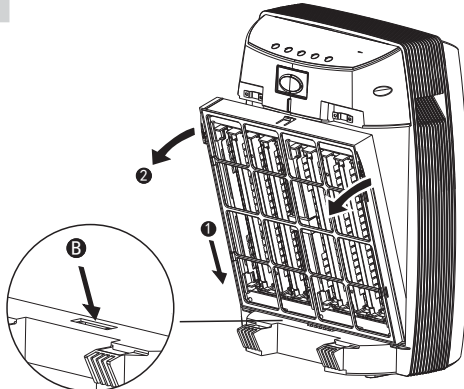

1. Push the dust collector cell towards the bottom of the device
2. Hold the two tabs and pull forward the dust collector cell

#### When assembling

1. Insert into position B
2. Firmly reconnect the dust collector cell back to its original position

### 3 Remove the Pre-filter

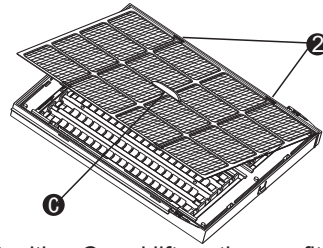

Hold the Position C and lift up the pre-filter

#### When assembling

1. Attach the filter to the connecting locations on the side
2. Fasten the filter on the front connecting locations.

### 4 Remove the HEPA/Activated carbon filter

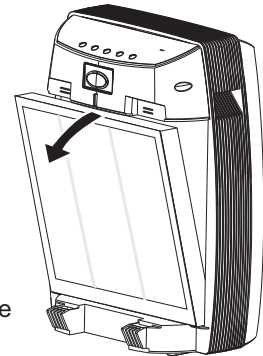

Hold the strap to help pulling out the filter.

#### When assembling

Install the filter with exact front-and-back direction as indicated on the sides of the filter. Do not reverse the front and back of the filter.

### 5 Remove the Formaldehyde/ TiO<sub>2</sub> Filter

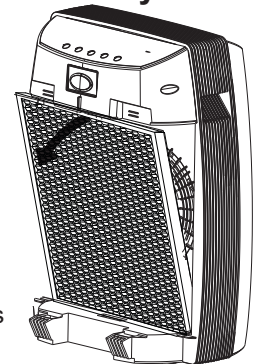

Hold the strap to help pulling out the filter

#### When assembling

Install the filter with exact front-and-back direction as indicated on the sides of the filter.

# CLEANING AND MAINTENANCE

## CLEANING AND MAINTENANCE

### 1 Clean the Front Cover

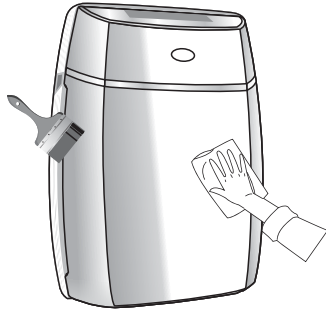

- Use a soft and wet cloth to clean, avoid scraping off the paint on the cover.
- Use provided brush to clean the air inlets and outlets

### 2 Clean the Pre-filter

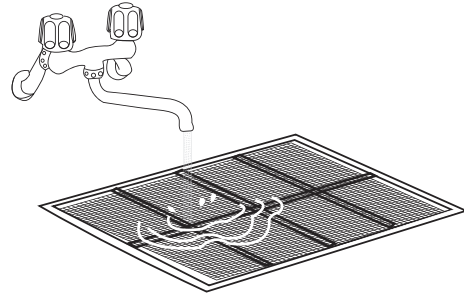

- Suggested cleaning time: 2-4 weeks
- Rinse thoroughly by flowing water and dry

### 3 Clean the Dust Collector Cell

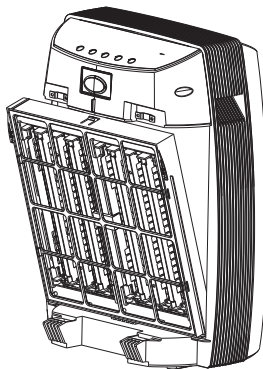

- Suggested cleaning time: 4-8 weeks
- Cleaning method please refer to instructions on page 11

### 4 Replace the filters

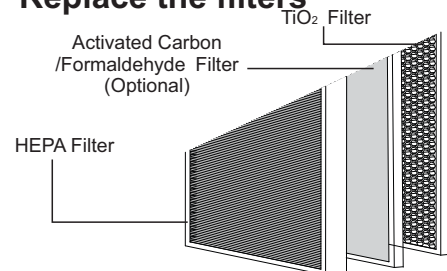

- Suggested cleaning time: 6 months
- When filters is dark grey or "REPLACE FILTER" indicator appears
- TiO<sub>2</sub> Filter: use a vacuum cleaner to eliminate dust on the filter.

### 5 Clean the Sensor

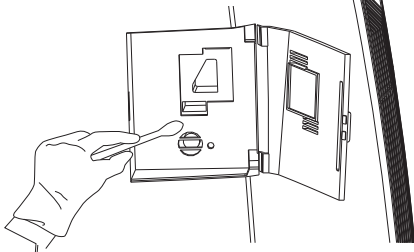

- Suggested cleaning time: 1-2 months
- When sensor gets dirty or blacked by other objects, use cotton swab to wipe dust off, otherwise the sensitivity will decrease.

### 6 Clean the Unit Body

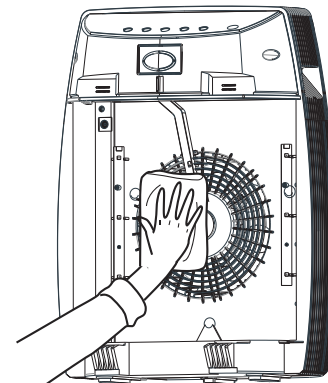

- When Cleaning, do not get the UV LED wet
- Using wring dry cloth to clean

# CLEANING AND MAINTENANCE

## Reset the "REPLACE FILTER" indicator

- Please refer to instructions on page 7 for resetting after replacement, otherwise the indicator will remain on screen.

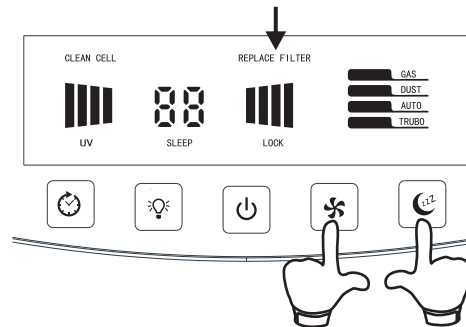

## Cleaning the Dust Collector Cell

### Caution

The dust collector cell may not require cleaning if "arcing" occurs. Arcing is a sharp snapping sound that occurs when large particles are collected in the dust collector cell or the appliance used in over damp rooms.

### The dust collector cell needs cleaning when:

- "CLEAN CELL" indicator appears or blinks on the screen
- The dust collector cell is too dirty or continuous arcing occurs

#### 1 Remove the front cover, dust collector cell and pre-filter

- Please refer to page 9 for detailed instructions on the removal of the dust collector cell and pre-filter.

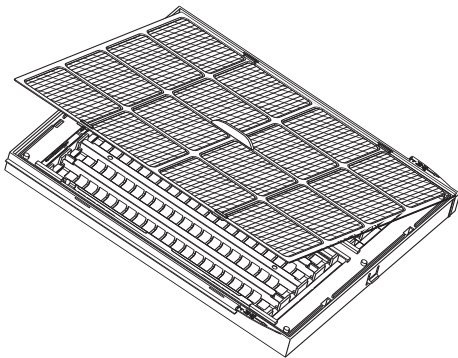

#### 2 Soak the dust collector cell before cleaning

- Place the dust collector cell in sink, bathtub or other location where cleaner can cover every surface.
- Tough residue such as tar from tobacco smoke does not wash away easily:
  - ① Use mild detergent
  - ② Use warm water (below 40°C) only!

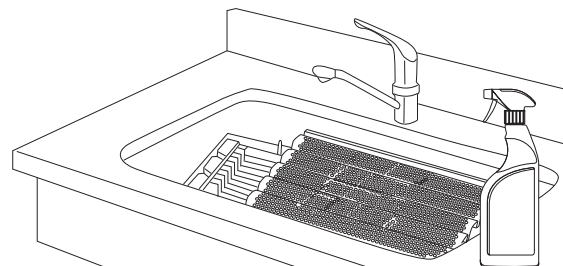

# CLEANING AND MAINTENANCE

## 3 Clean the dust collector cell

- Use provided brush or toothbrush to clean.
- Please take care not to damage any wiring while cleaning the dust collector cell, if any wire is broken, the unit will lose part or all of its dust collecting capability.
- Any broken wire should be thrown away instead of being left inside the unit. Otherwise, a dangerous short-circuit or high-voltage sparks may occur. Please contact authorized service center for maintenance or replacement.

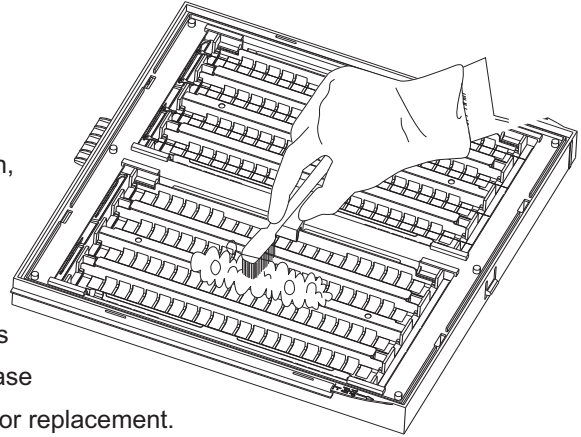

## 4 Thoroughly dry the dust collector cell

- Shake excess water from the dust collector cell to speed up drying time.
- DO NOT install a damp dust collector cell directly into the unit may cause dangerous short-circuit or malfunction.

**Note :** If the front cover or dust collector cell is not properly installed after cleaning, the unit will not operate.

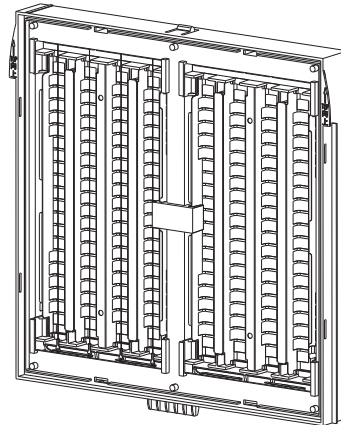

## 5 Reset the "CLEAN CELL" indicator

- Please refer to instructions on page 7 for resetting after cleaning, otherwise the indicator will remain on screen.

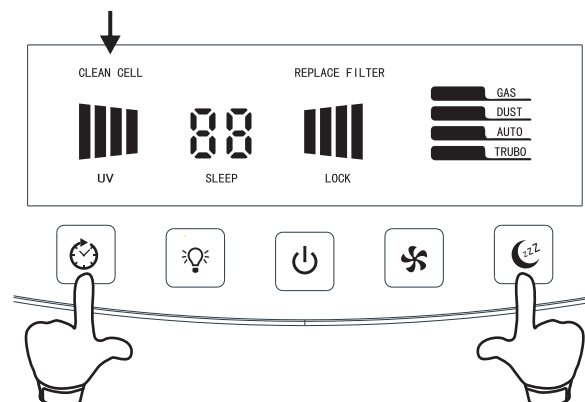

# TROUBLESHOOTING

Service problems that appear to be major can often be solved easily. You can be your own troubleshooter by reviewing this guide.

**All other servicing should be done by a local authorized service center.**

Problem	Check	Solution
Appliance does not turn ON	<ul style="list-style-type: none"> <li>● Power cord</li> <li>● Power button</li> <li>● Front cover/Dust collector cell</li> </ul>	<ul style="list-style-type: none"> <li>● Plug in power cord</li> <li>● Press the power button.</li> <li>● Make sure the front cover and dust collector cell is securely closed.</li> </ul>
Red "REPLACE FILTER" indicator has illuminated	Filters	Please replace filters and reset the timer. Refer to instructions on page 7&9.
Red "CLEAN CELL" indicator has illuminated.	Dust collector cell	Please wash collector cell and reset the timer. Refer to instructions on page 7&9&11.
Dust collector cell does not remove particles	Dust collector cell	<ul style="list-style-type: none"> <li>● Dust collector cell gets too dirty, please clean</li> <li>● Dust collector cell may be damaged</li> <li>● Dust collector is not completely dry after cleaning</li> <li>● Wiring is not assembled well or broken. Contact authorized service center.</li> </ul>
HEPA filter does not remove dust	HEPA filter	<ul style="list-style-type: none"> <li>● The front and back of the HEPA filter been mistakenly reversed</li> <li>● The HEPA filter has been saturated with a serious amount of dust.(Usually dark grey in color). Please replace filter.</li> </ul>
Appliance sparks, crackles and pops	Dust collector cell	<ul style="list-style-type: none"> <li>● Sparking or popping noise (arcing) can occur when a large particle is captured in the collector cell or appliance is used in over damp rooms. If the appliance is arcing excessively, the cell may be dirty. Try cleaning the collector cell.</li> <li>● If excessive arcing continues after proper cleaning, the collector cell may be damaged. If damaged, contact authorized service center.</li> </ul>
Unpleasant smell in the air outlet	Filter & Dust collector cell	<ul style="list-style-type: none"> <li>● If filter gets too dirty, please replace</li> <li>● If dust collector cell gets too dirty, please clean</li> </ul>

# TROUBLESHOOTING

Problem	Check	Solution
“CLEAN SIGN” is always displaying polluted	Environment	<ul style="list-style-type: none"> <li>● Open the window to improve the ventilation</li> </ul>
	Sensors	<ul style="list-style-type: none"> <li>● Dust sensor gets dirty, please clean the dust sensor, refer to instructions on page 10</li> <li>● Possibly because the room is not really a closed environment and pollution keeps coming in from the outside. Or because there has been pollution created indoors (e.g. smoking/pet boxes etc.) the whole time. It will take some time for the appliance to achieve a clean environment.</li> </ul>
“CLEAN SIGN” is always displaying green	Sensors	<ul style="list-style-type: none"> <li>● Indoor air has been clean the whole time.</li> <li>● The sensor could be too far away from any irritant for it to detect. Please move the unit closer to your major sources of pollution.</li> <li>● For testing purpose, dust either caused by a cigarette or a dusty cloth can be released near the sensor. If the clean sign color changes, then the appliance should be operating properly.</li> </ul>
Gas or Dust sensor does not work or indicator is blinking	Environment	<ul style="list-style-type: none"> <li>● Indoor air quality is very bad, open the window to improve ventilation</li> </ul>
	Dust sensor	<ul style="list-style-type: none"> <li>● Dust sensor gets too dirty, refer to instructions on page 10 for cleaning</li> </ul>
	Gas sensor	<ul style="list-style-type: none"> <li>● In the initial set-up of the appliance, the gas sensor did not get properly retained. Please refer to page 5 for retaining the sensor memory.</li> <li>● For initial use or the unit has been unplugged for more than a week, the sensor will not be as sensitive. After 1-2 days operation, the sensor will regain its sensitivity.</li> <li>● Gas/Dust sensor gets malfunction, contact authorized service center</li> </ul>
“Fan mode” indicator is blinking	Environment	<ul style="list-style-type: none"> <li>● Indoor air quality is very bad, open the window to improve ventilation</li> </ul>
	Appliance	<ul style="list-style-type: none"> <li>● Appliance gets malfunction, contact authorized service center</li> </ul>



## SPECIFICATIONS

Model	AP-HC300B
Rated Voltage	AC110~120V/50-60Hz AC220~240V/50Hz
Power	55W (Not include UV LED 10W)
Activated Oxygen Output	≤0.05ppm
Noise Level (dB)	Silent 25/Low 35/Med 45/High 55dB/Turbo 60dB
CADR Value	300M <sup>3</sup> /H
Dimensions (mm)	410×288×535mm
Room Size	20-50m <sup>2</sup>
Net Weight	6.8kg

## Real Spirit USA, Inc.

320 South Rock Blvd. Ste. 210

Reno, Nevada 89502

Tel: 1-888-601-5886

Website: [www.AdvancedPureAir.com](http://www.AdvancedPureAir.com)

[Info@AdvancedPureAir.com](mailto:Info@AdvancedPureAir.com)