

# X1-VIPER Instruction manual Dash board and Front Deck Mount

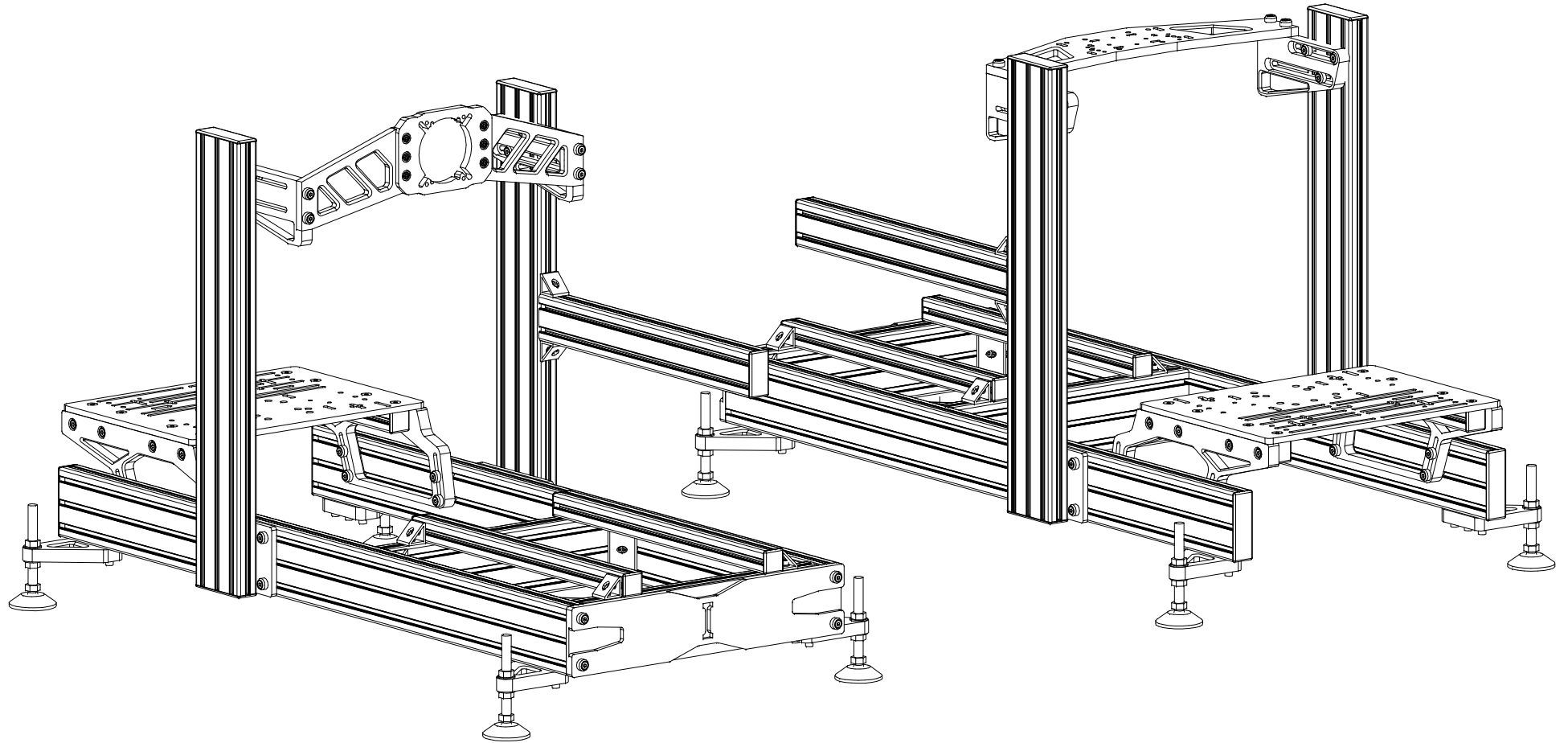

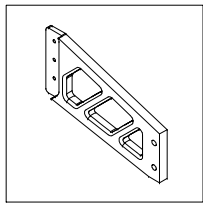

L & R x 2

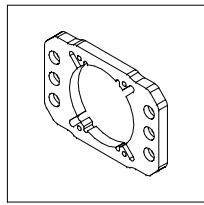

x 2

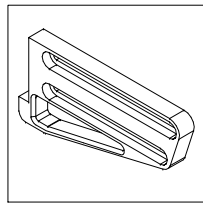

L & R x 2

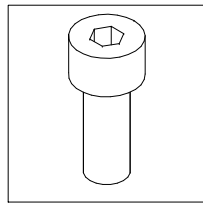

M8 x30mm x 4

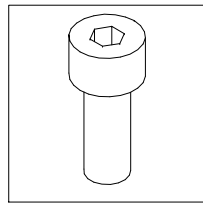

M8 x20mm x 6

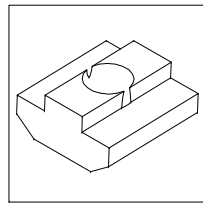

M8 x 6

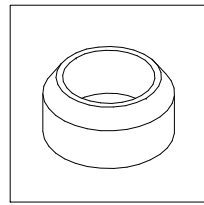

M8 x 10

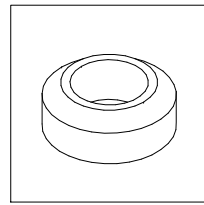

M6 x 6

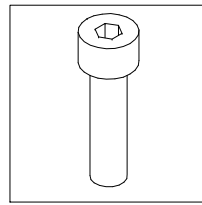

M6 x 20mm x 6

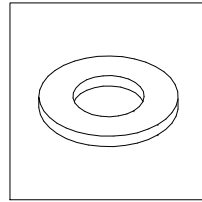

M6 x 6

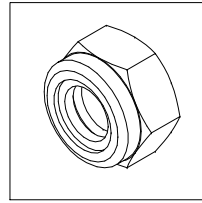

M6 x 6

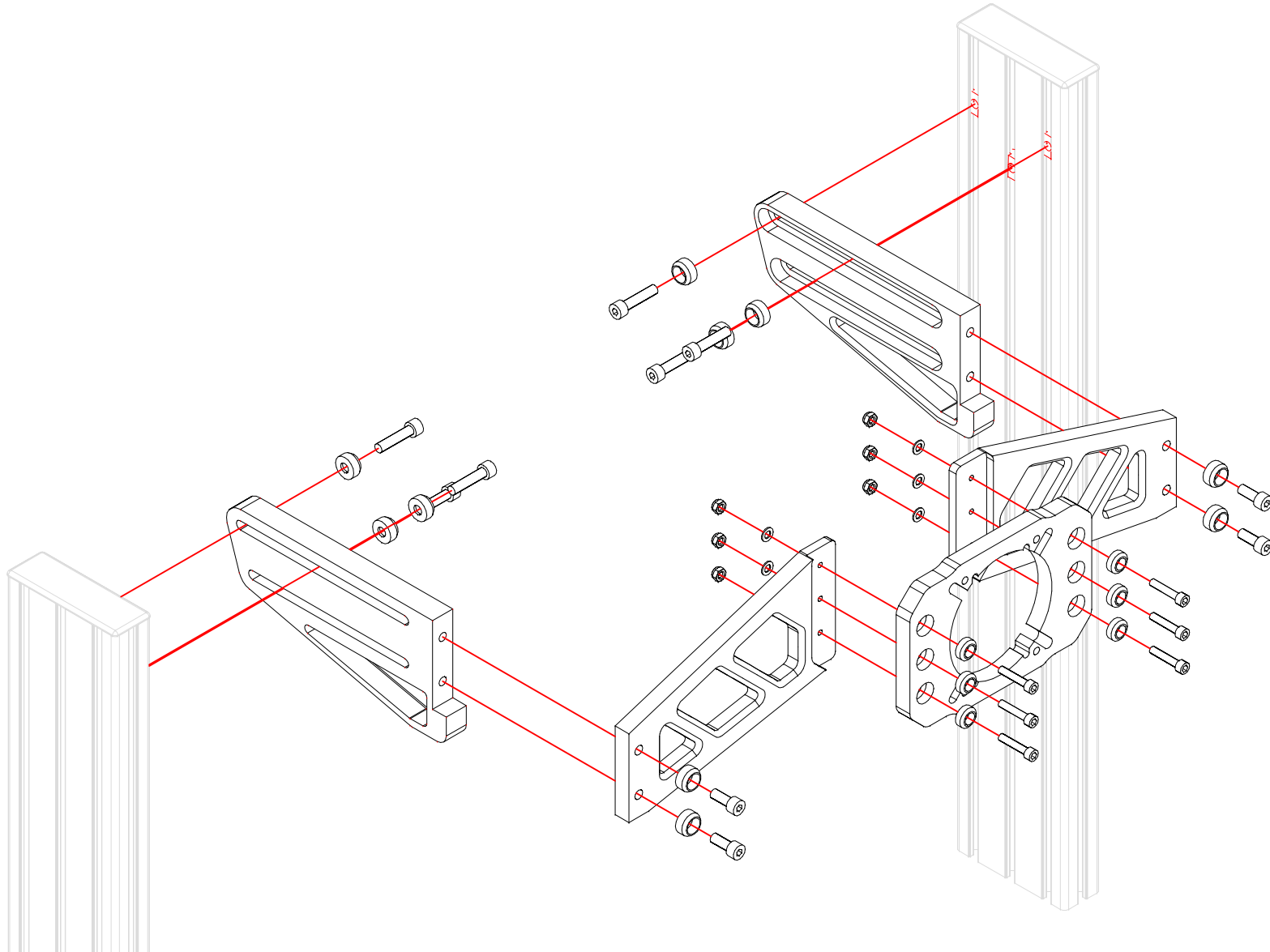

# XI-VIPER Front Deck Mount

# XI-VIPER Dash board Mount

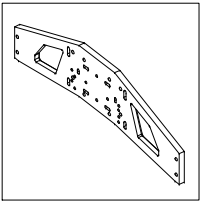

x 1

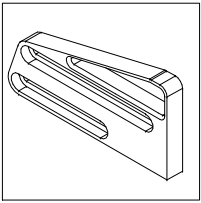

L & R x 2

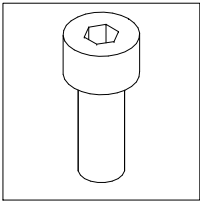

M8 x30mm x 4

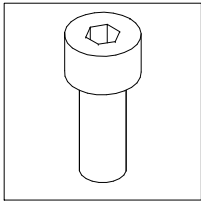

M8 x20mm x 6

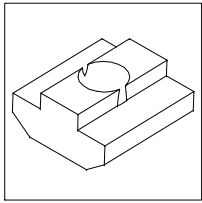

M8 x 6

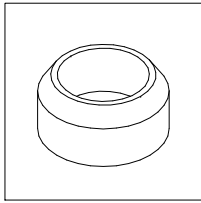

M8 x 10

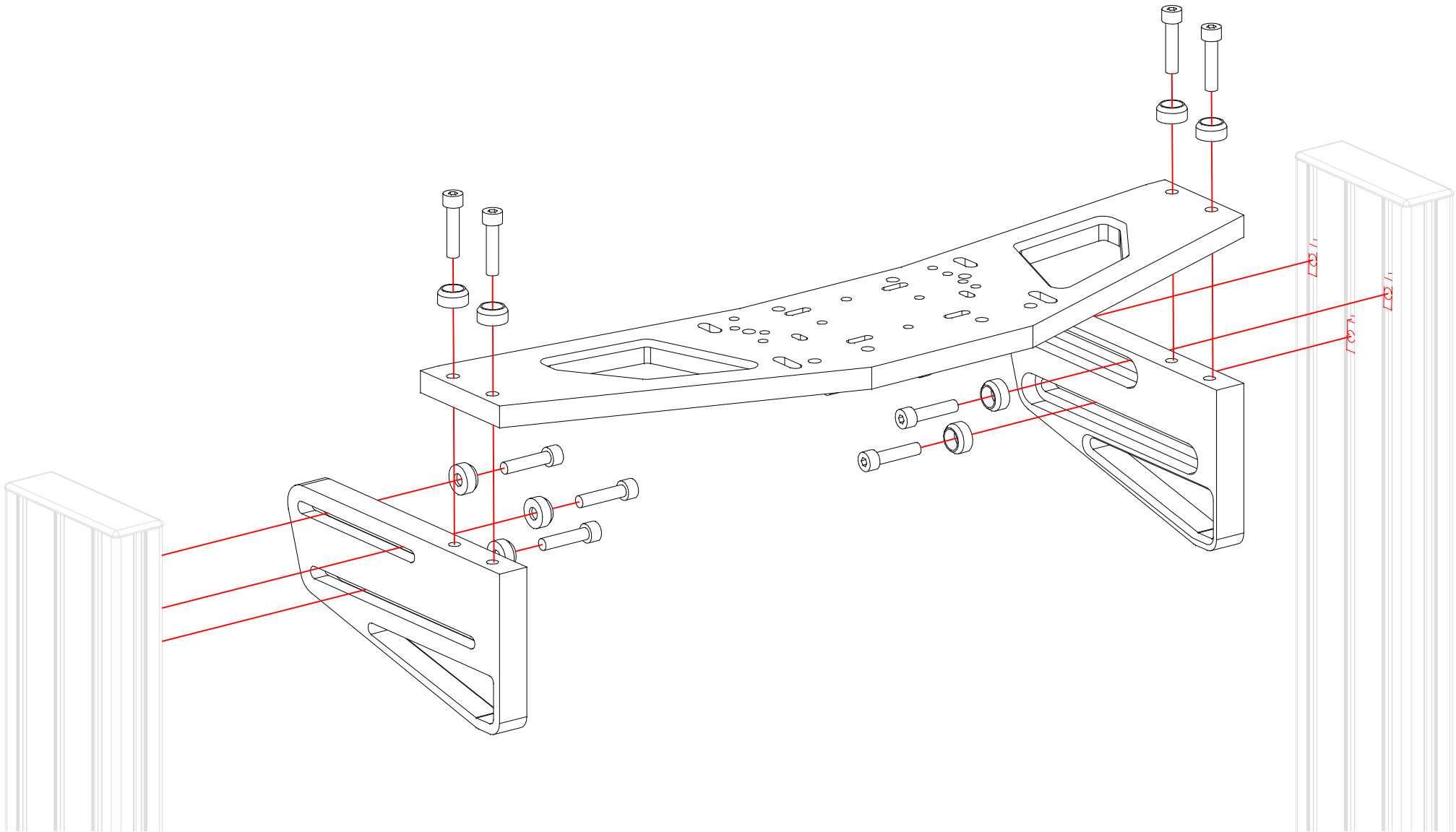

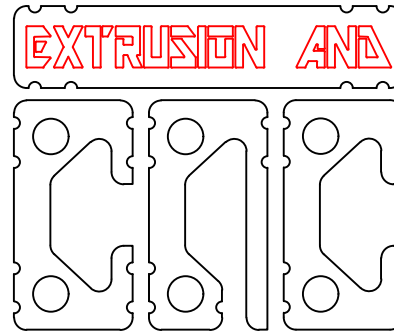

If you still have some questions regarding assembly of this product or about the manual itself, please refer to our support department. They can be reached at

[support@extrusionandcnc.com](mailto:support@extrusionandcnc.com)

whatsapp: +971506580398