

# Quad Monitor Stand Instruction manual

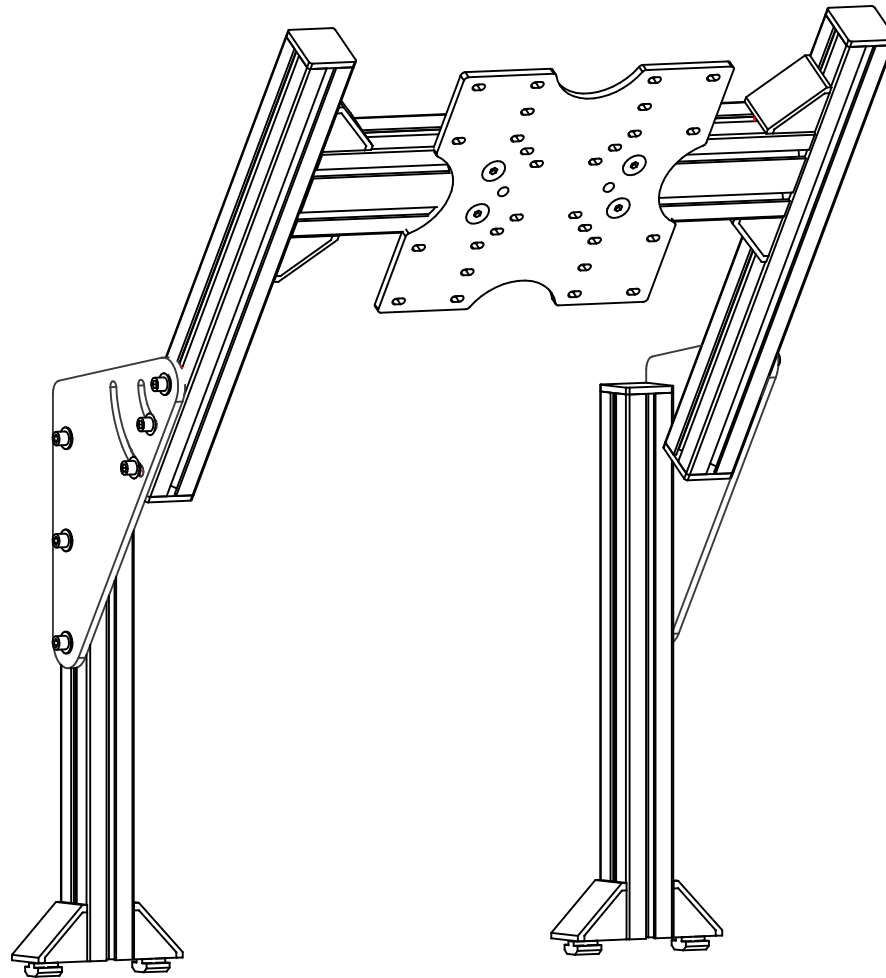

# Package Includes

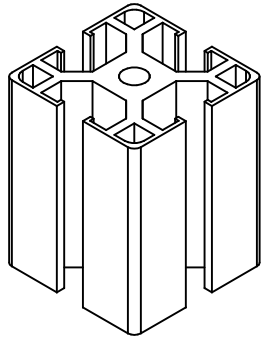

400mm x 4

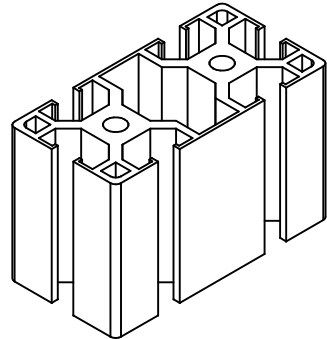

420mm x 1

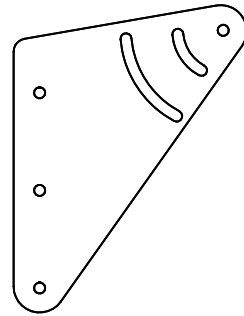

x 2

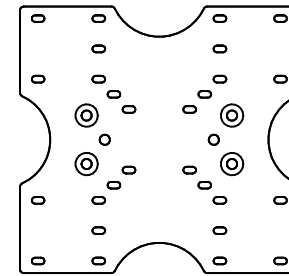

x 1

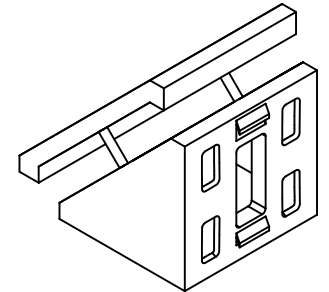

x 8

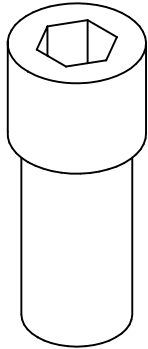

M8 x 16mm x 28

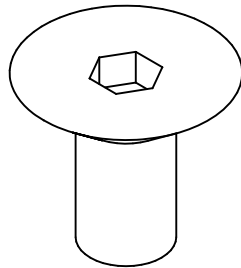

M8 x 16mm x 4

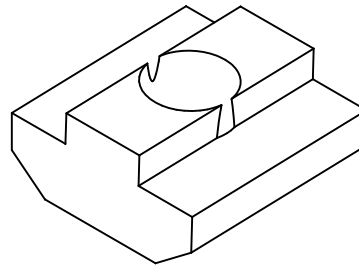

x 32

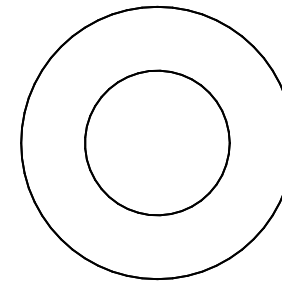

x 12

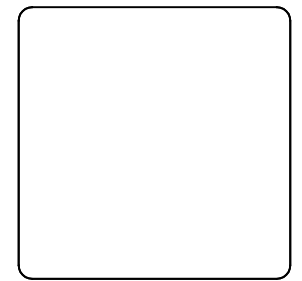

x 6

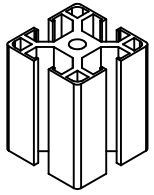

400mm x 4

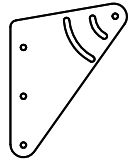

x 2

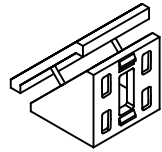

x 4

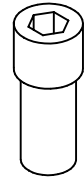

M8 x 16mm x  
20

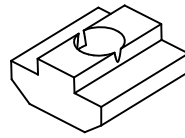

M8 x 20

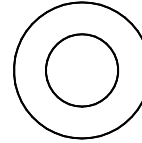

x 12

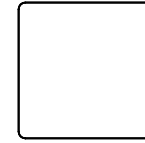

x 6

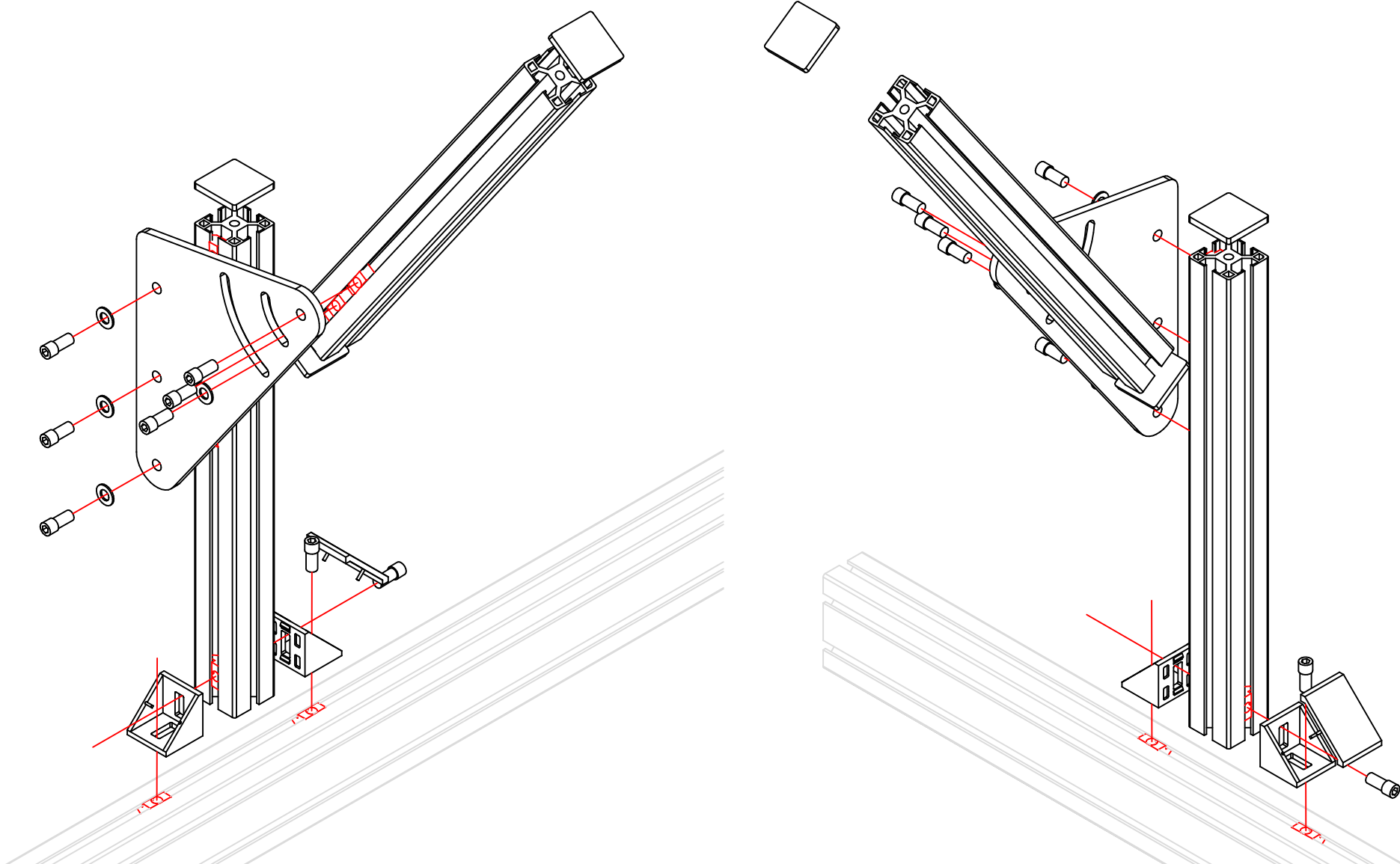

# Structure Fasteners Pack

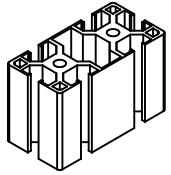

420mm x 1

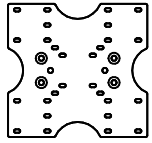

x 1

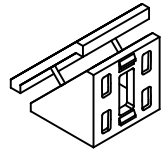

x 4

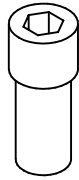

M8 x 16mm x 8

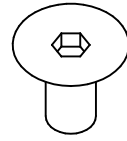

M8 x 16mm x 4

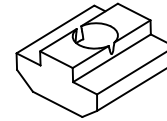

M8 x 12

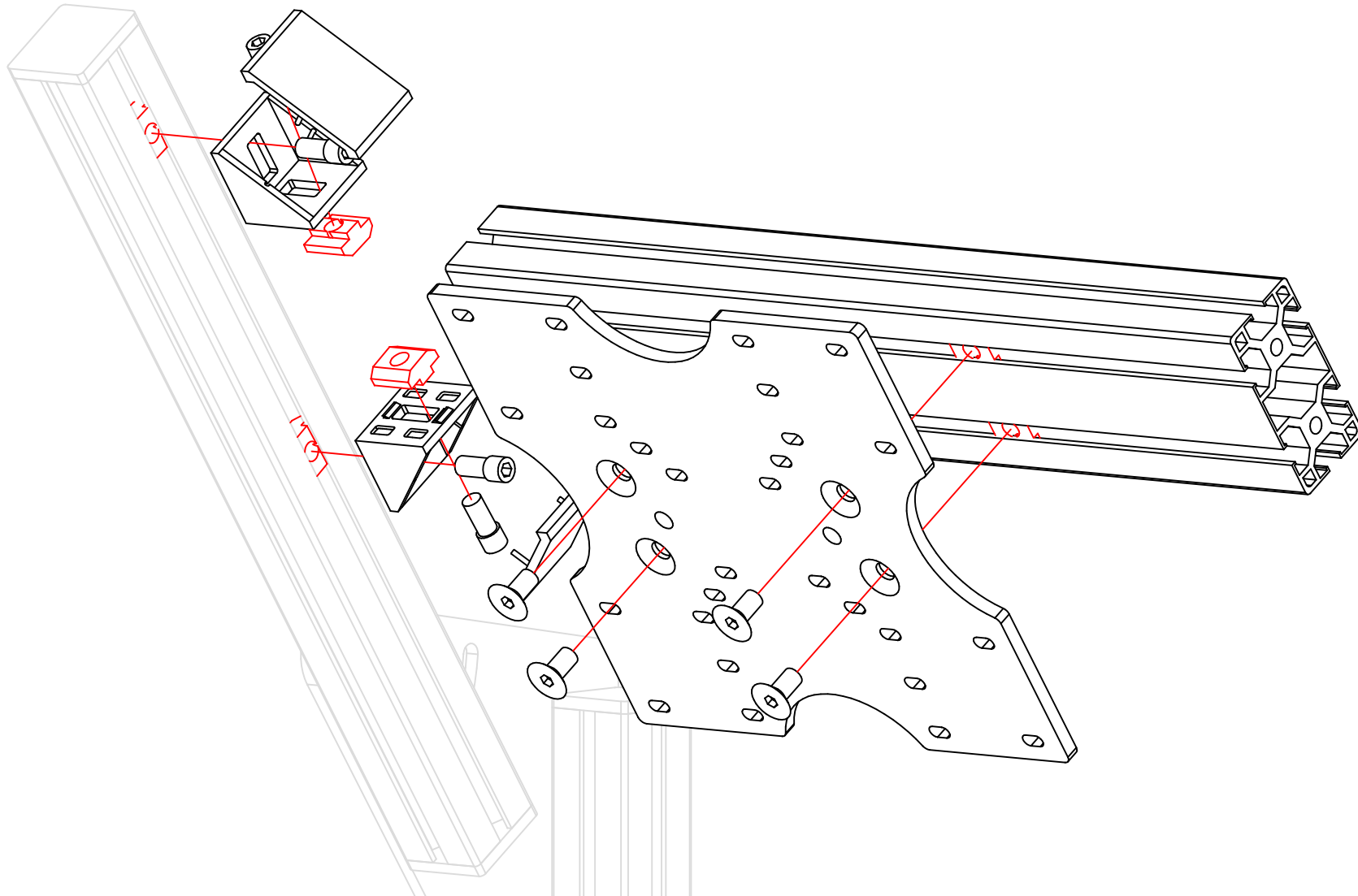

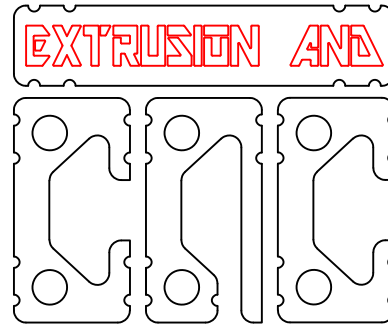

If you still have some questions regarding assembly of this product or about the manual itself, please refer to our support department. They can be reached at

[support@extrusionandcnc.com](mailto:support@extrusionandcnc.com)

whatsapp: +971506580398