

P1 - Pedal Mount Plate Instruction manual

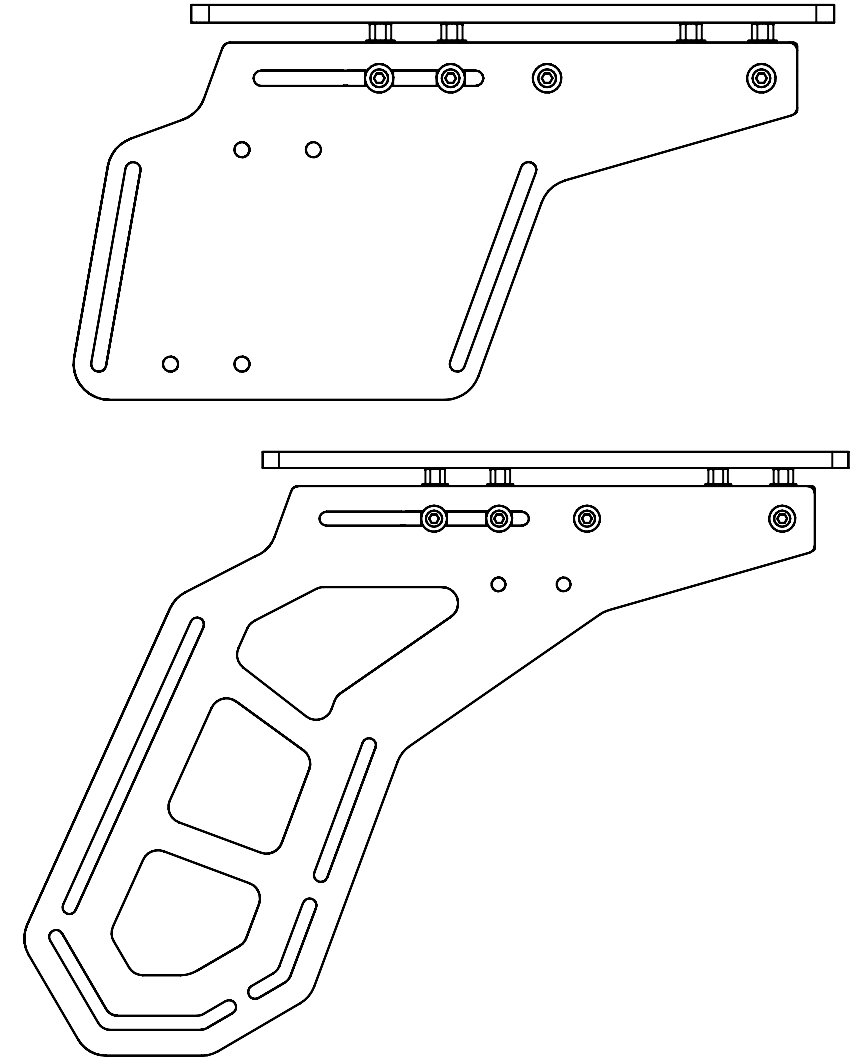

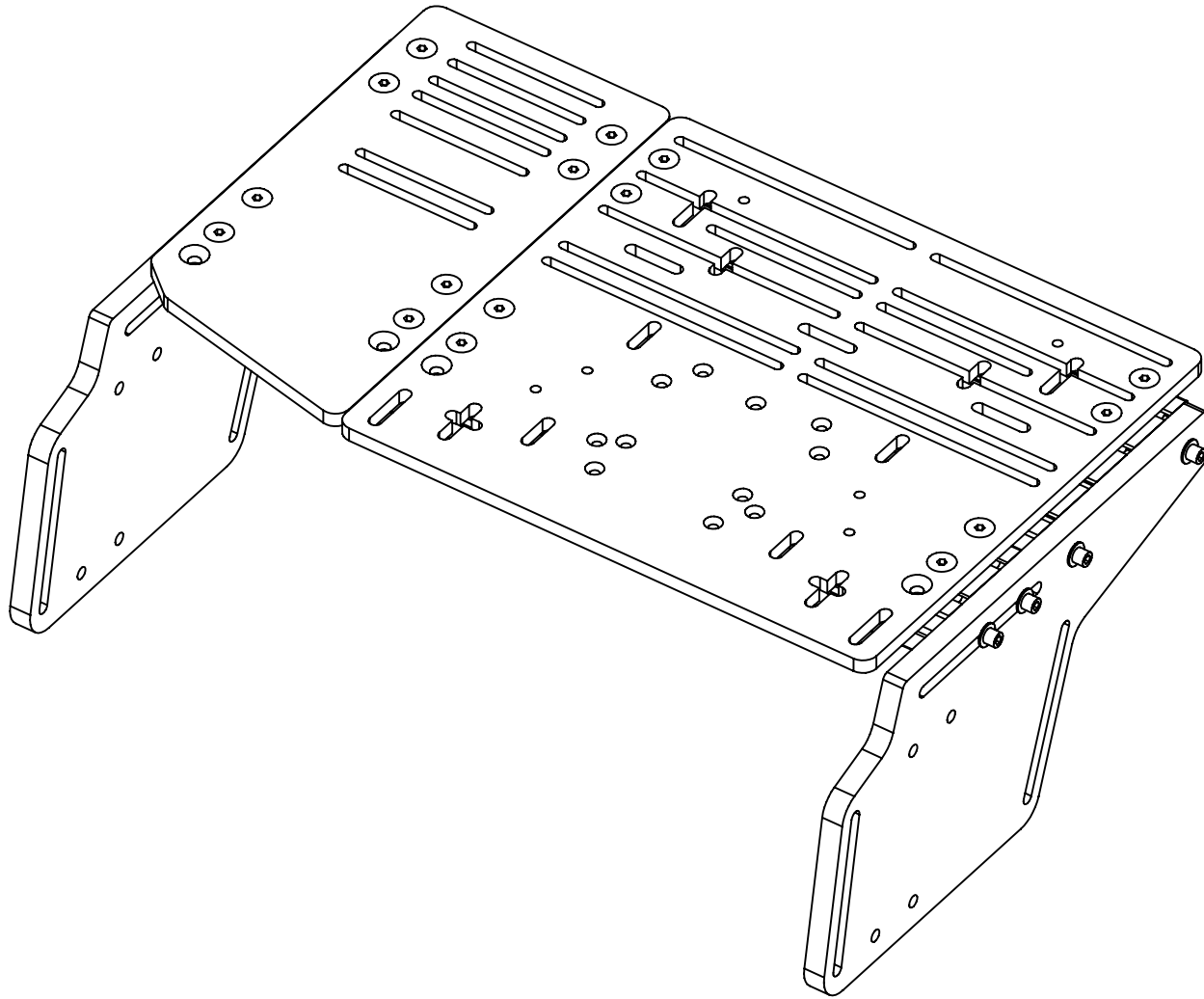

470mm x 1

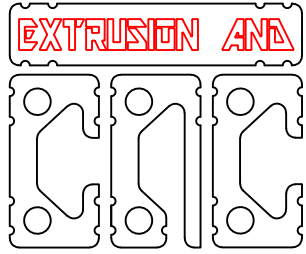
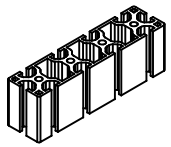
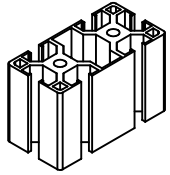

470mm x 1

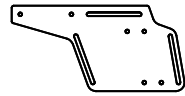

x 2



M8 x 25mm x
16

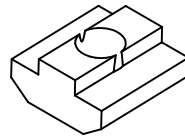

x 8

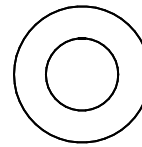

x 16

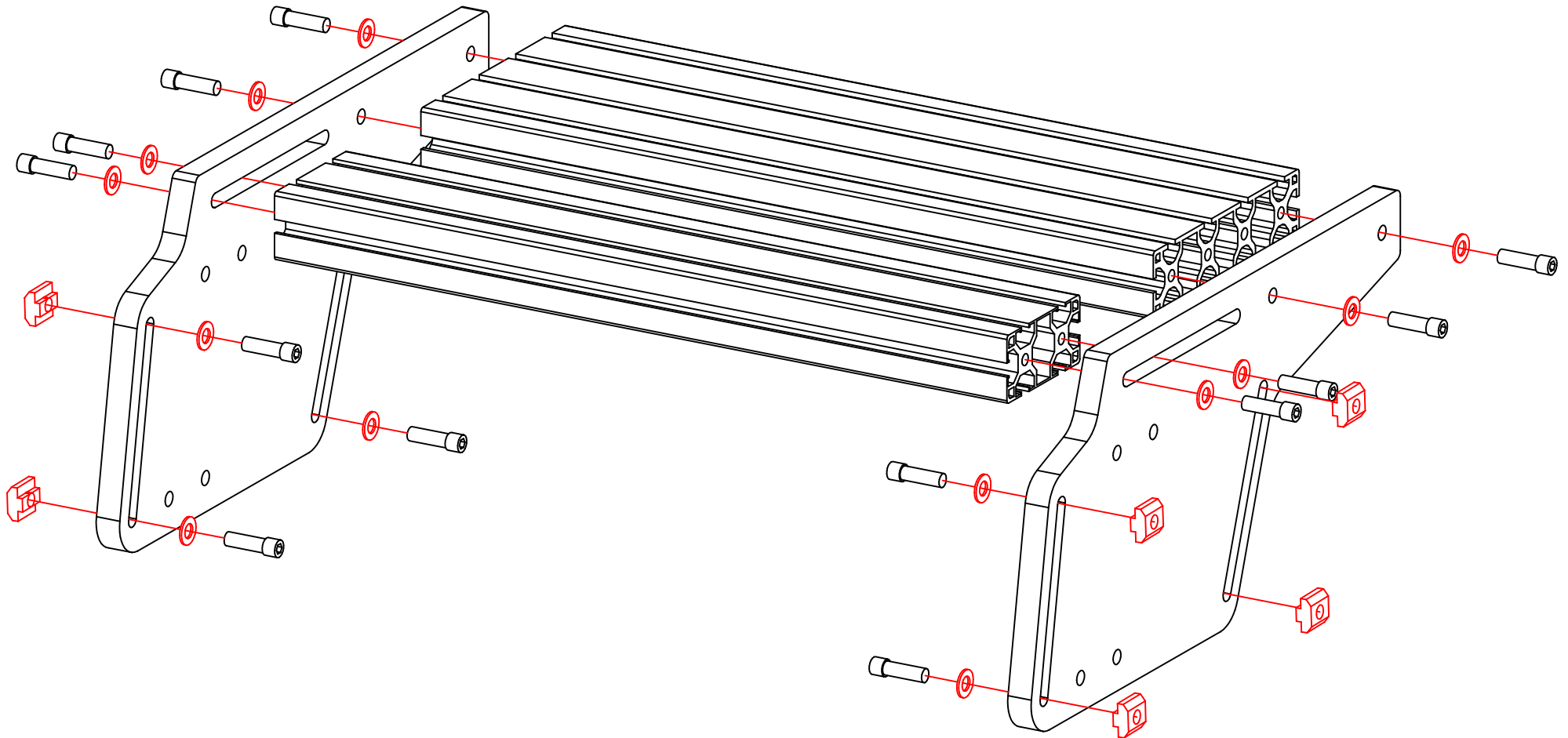

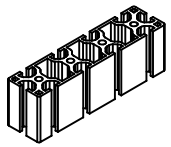

580mm x 1

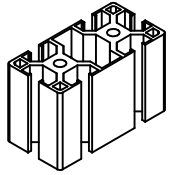

580mm x 1

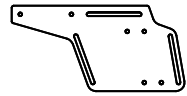

x 2



M8 x 25mm x
16

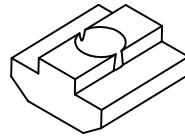

x 8

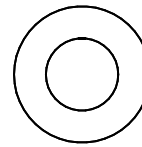

x 16

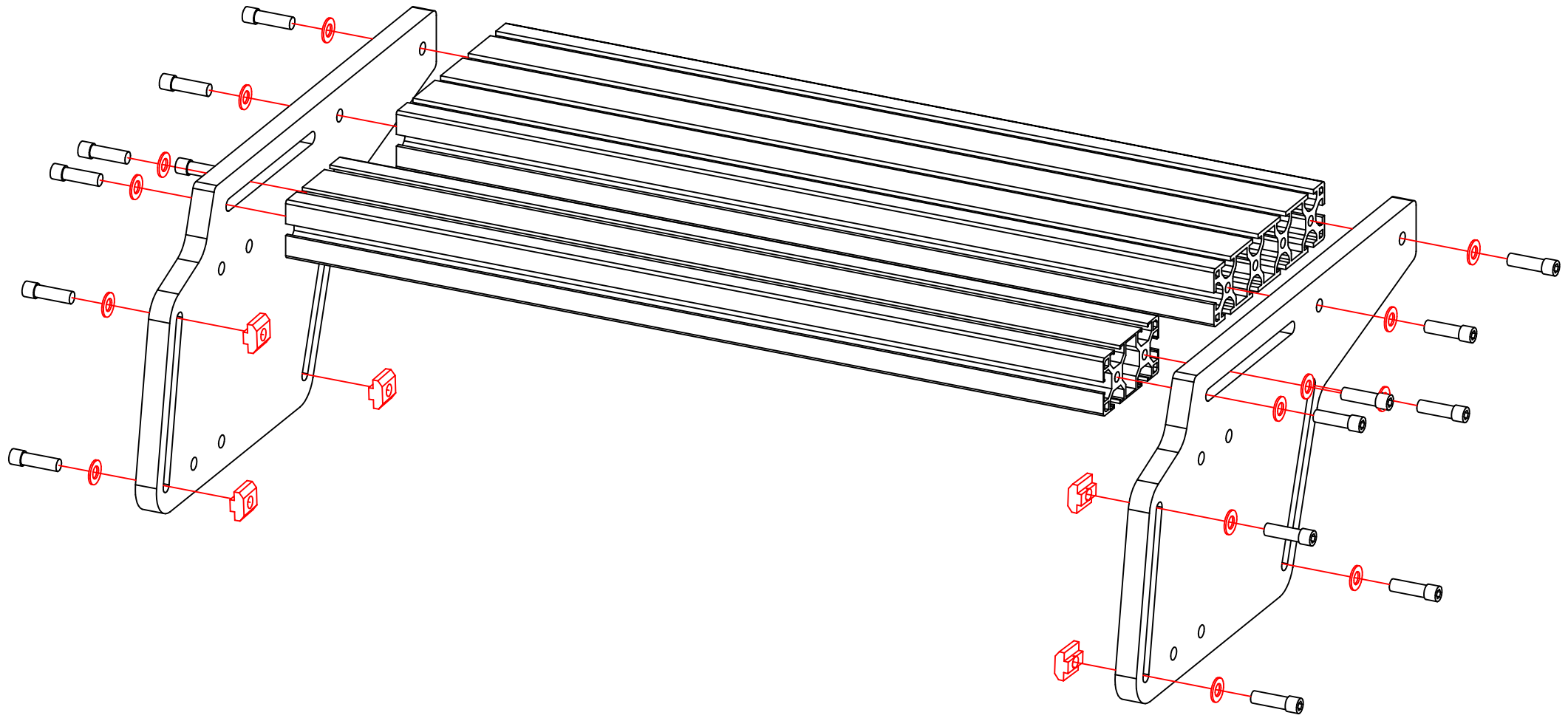

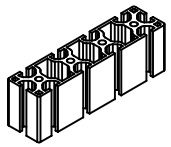

470mm x 1

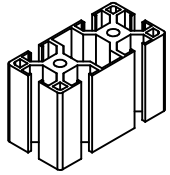

470mm x 1

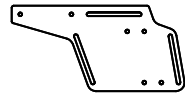

x 2



M8 x 25mm x
16

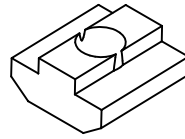

x 16

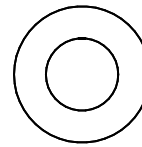

x 32

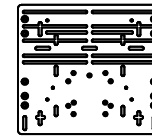

x 1

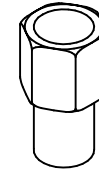

x 8

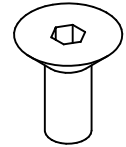

M8 x 20mm x 8

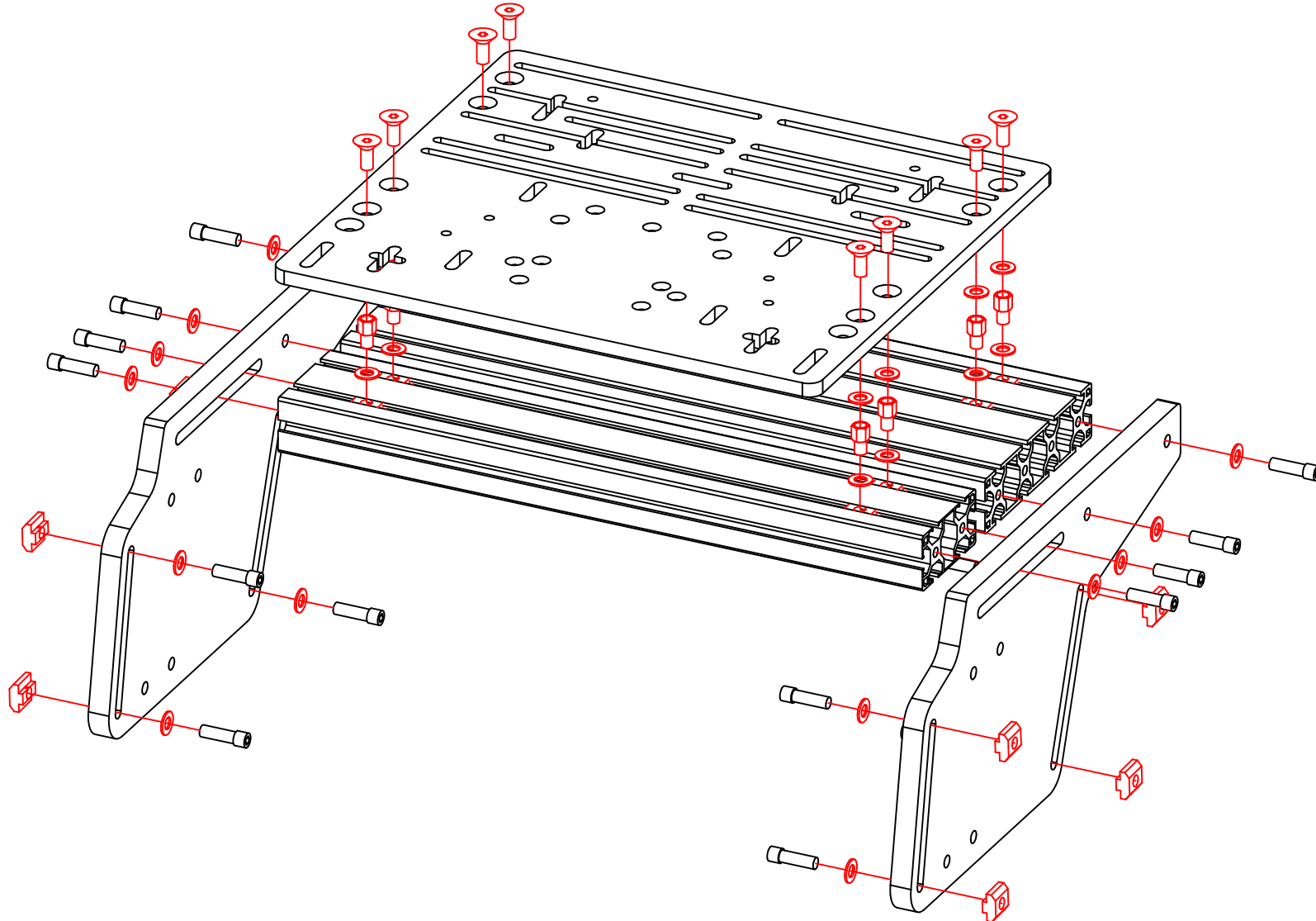

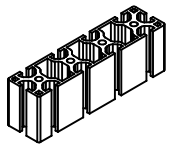

580mm x 1

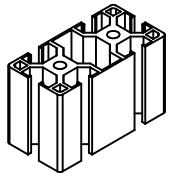

580mm x 1

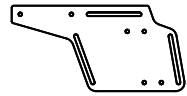

x 2

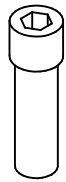

M8 x 25mm x
16

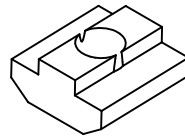

x 24

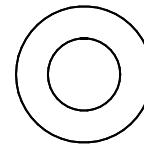

x 48

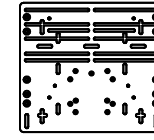

x 1



x 16

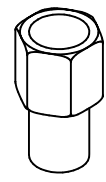

x 16

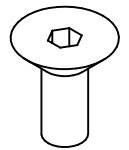

M8 x 20mm x
16

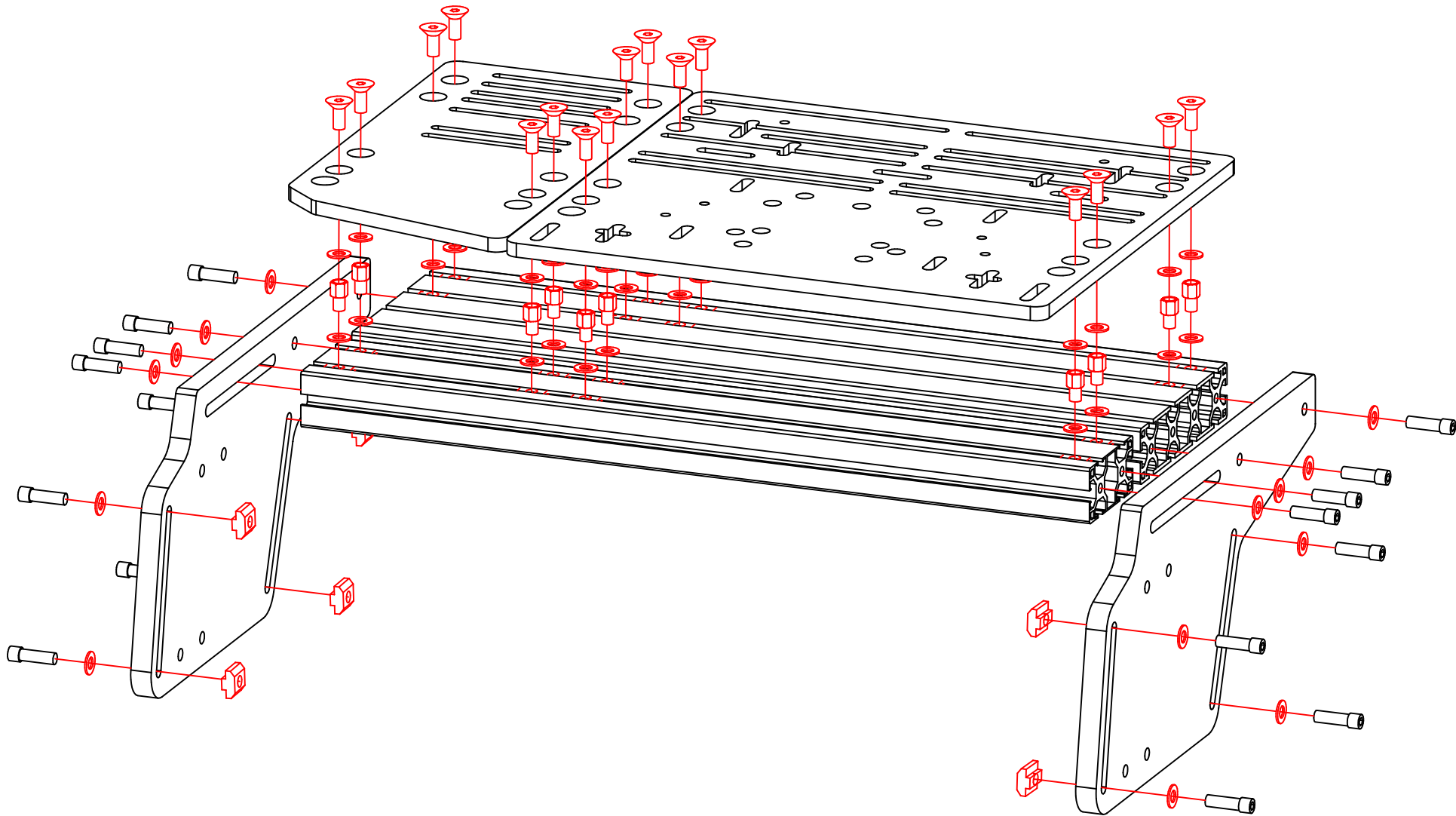

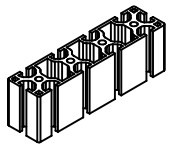

470mm x 1

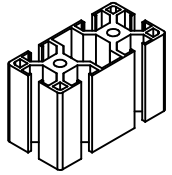

470mm x 1

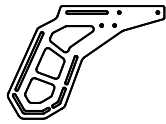

x 2



M8 x 25mm x
16

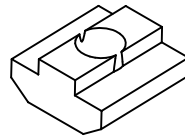

x 8

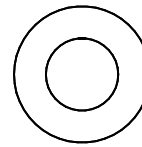

x 16

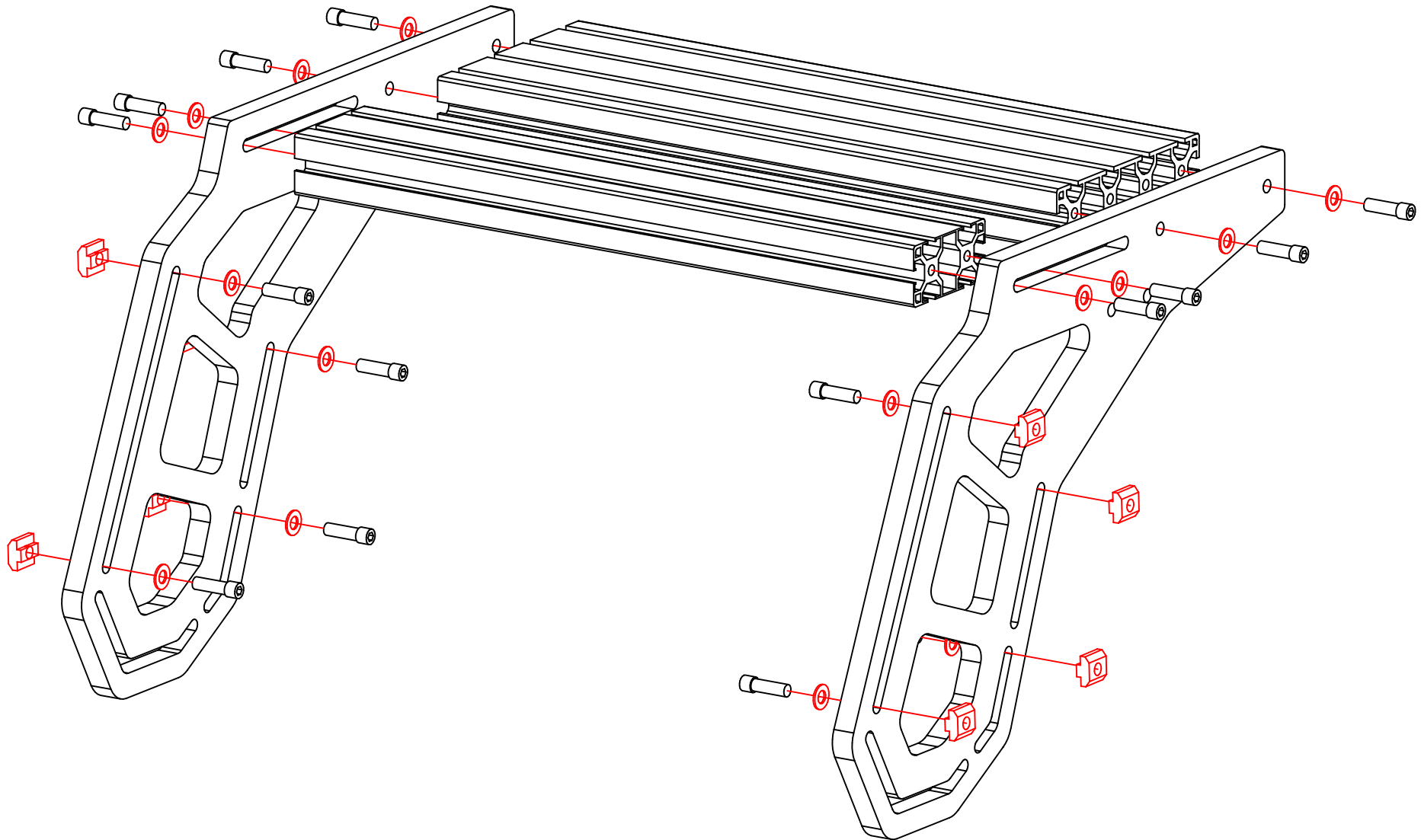

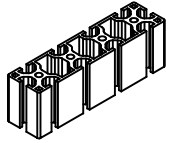

580mm x 1

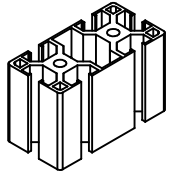

580mm x 1

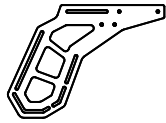

x 2



M8 x 25mm x
16

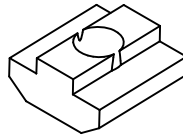

x 8

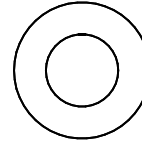

x 16

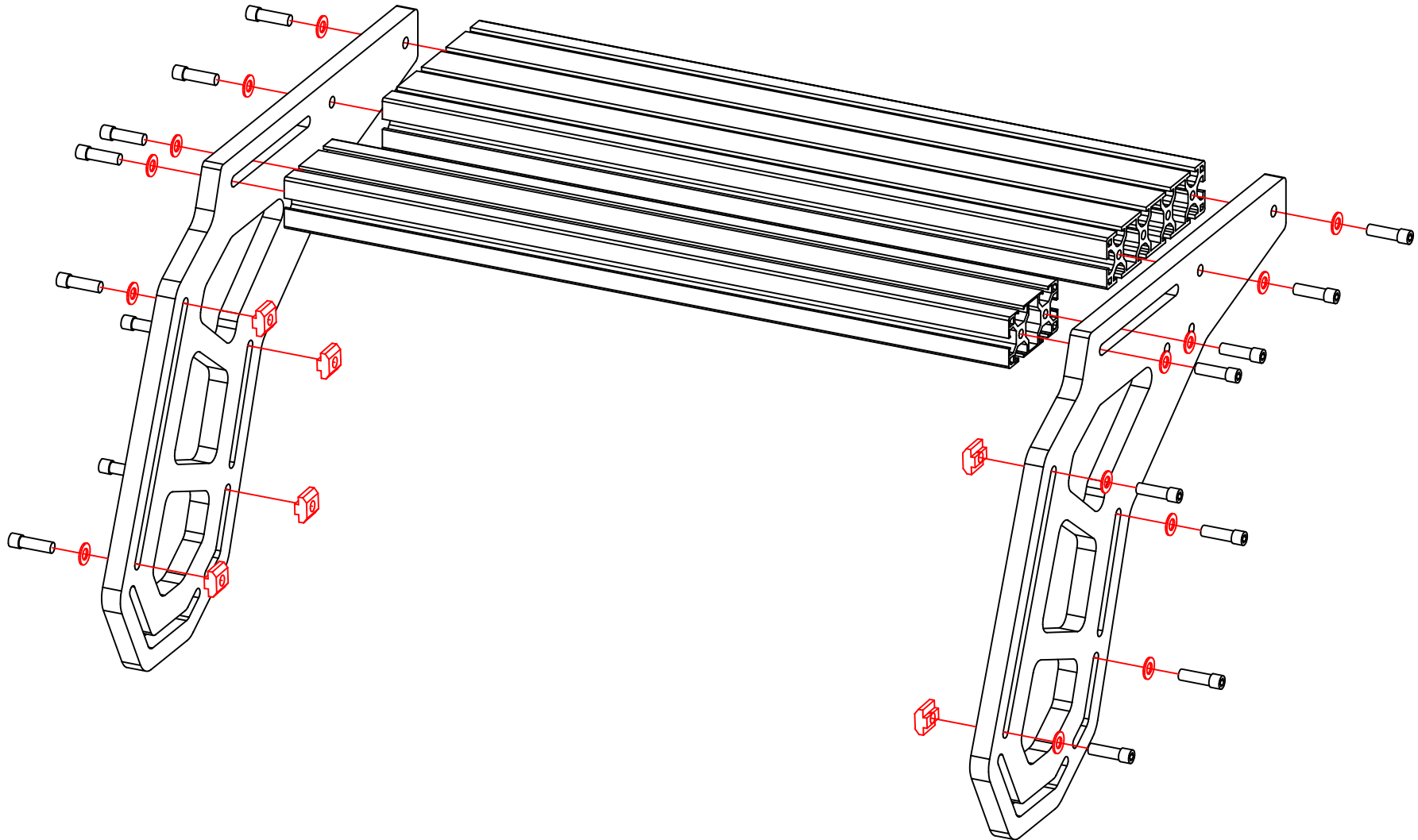

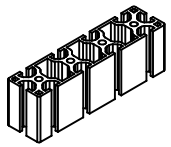

470mm x 1

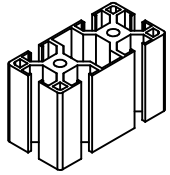

470mm x 1

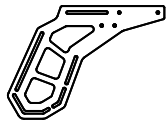

x 2



M8 x 25mm x
16

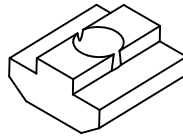

x 16

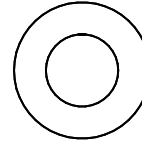

x 32

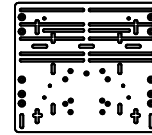

x 1

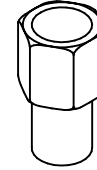

x 8

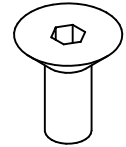

M8 x 20mm x 8

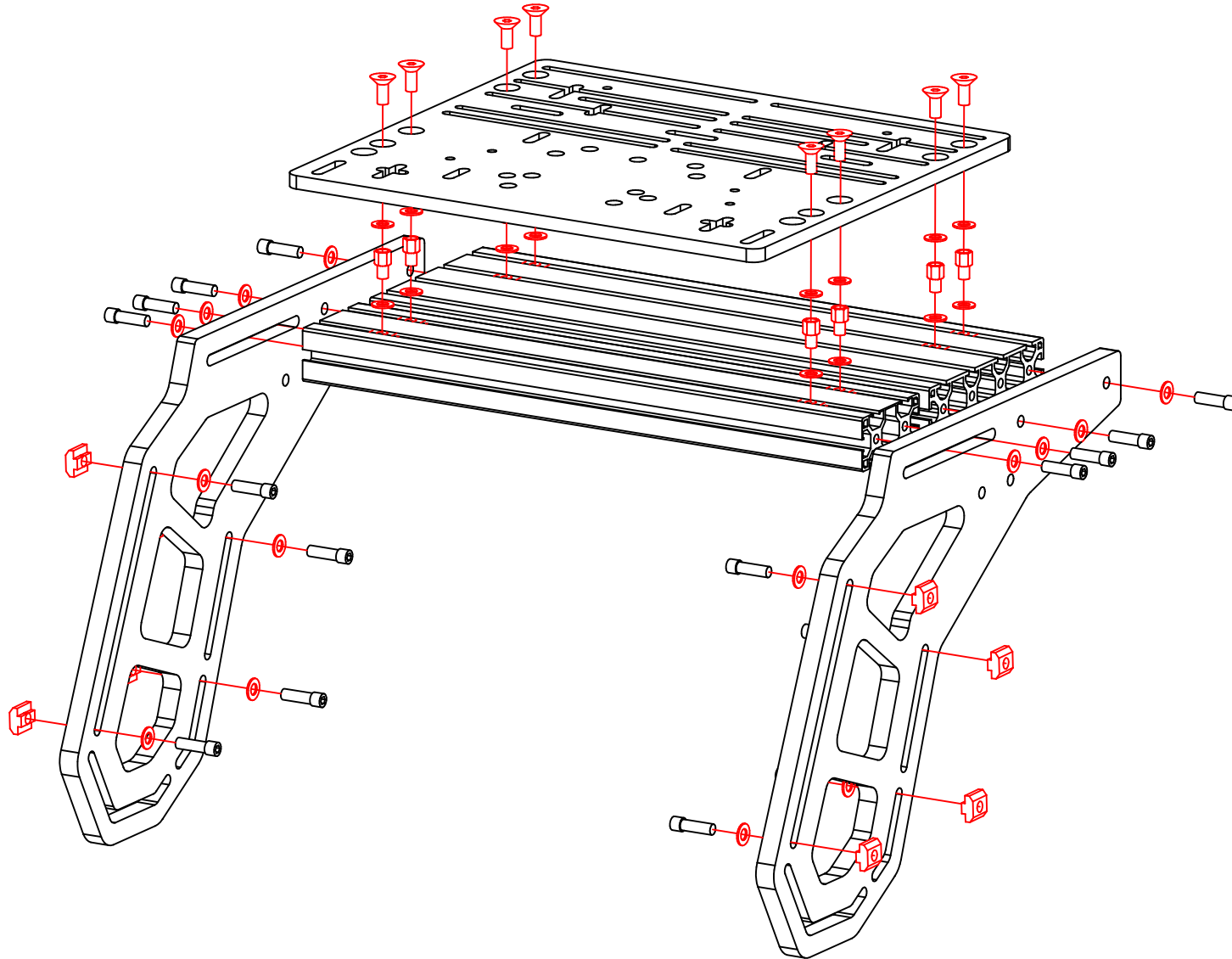

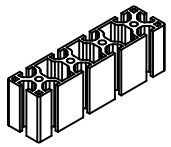

580mm x 1

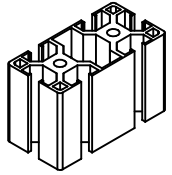

580mm x 1

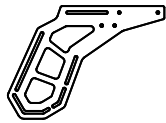

x 2



M8 x 25mm x
16

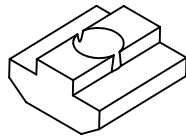

x 24

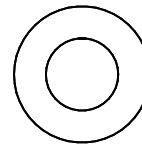

x 48

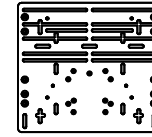

x 1

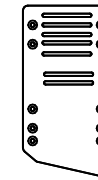

x 16

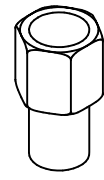

x 16

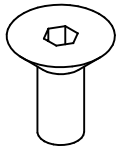

M8 x 20mm x
16

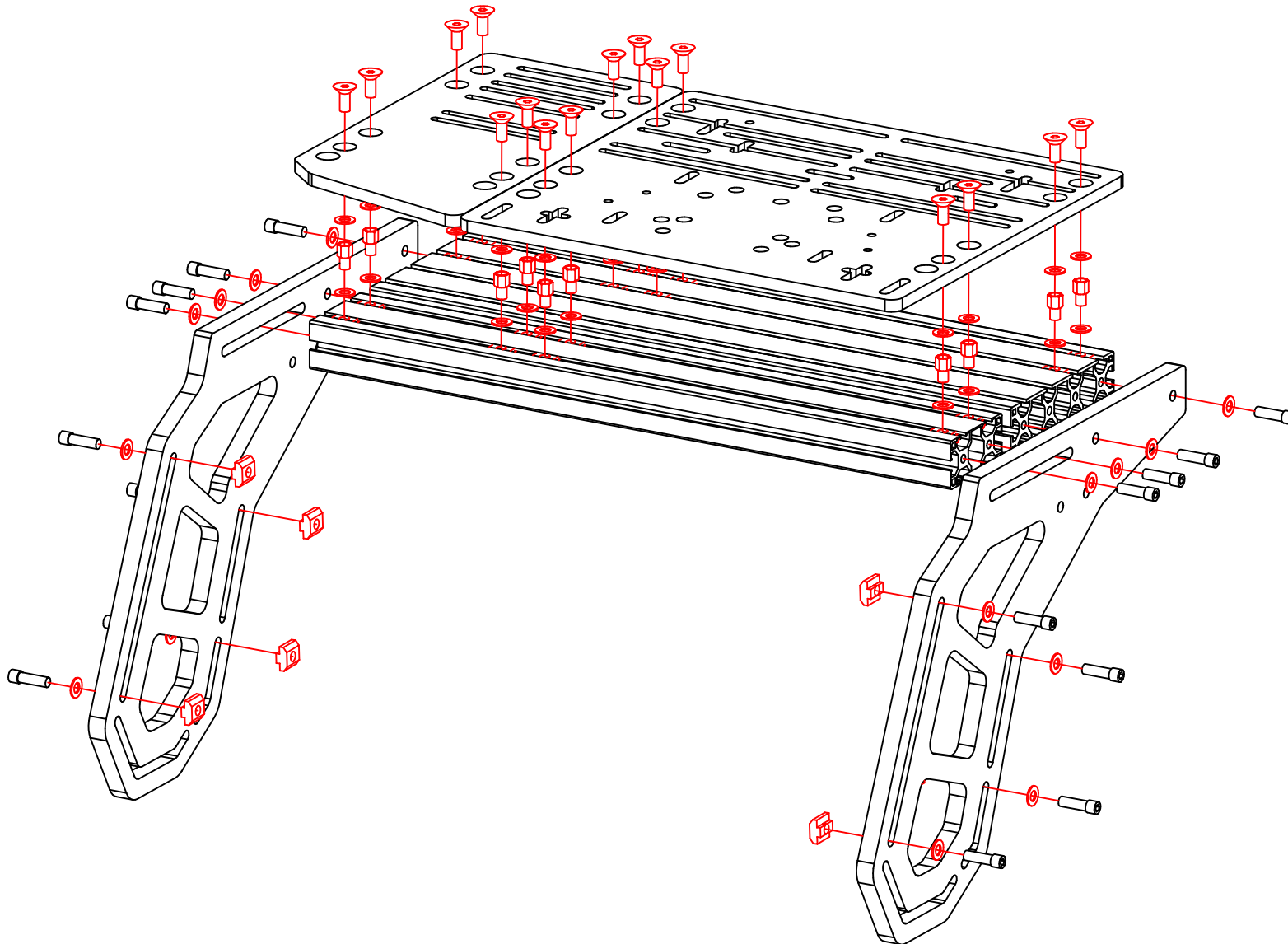

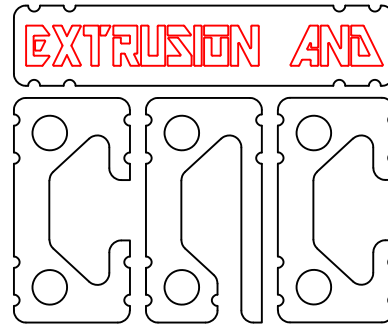

If you still have some questions regarding assembly of this product or about the manual itself, please refer to our support department. They can be reached at

support@extrusionandcnc.com

whatsapp: +971506580398