

# Package Includes

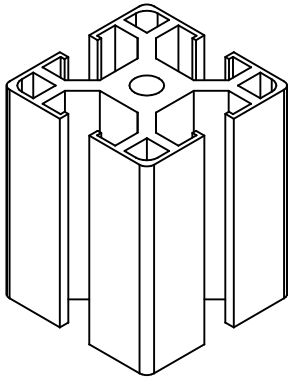

500mm x 2

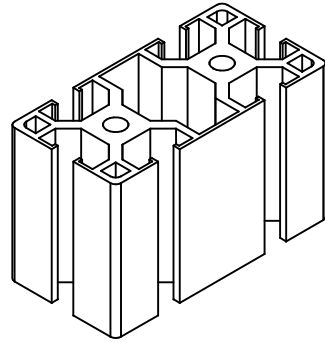

420mm x 1

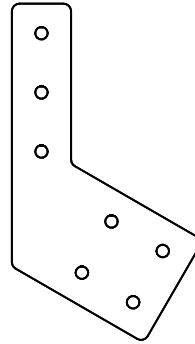

x 2

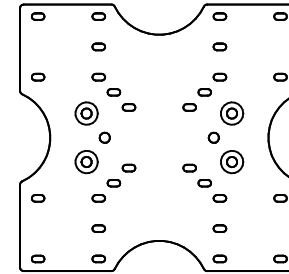

x 1

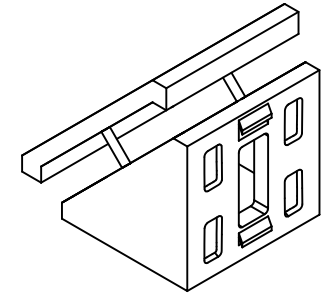

x 2

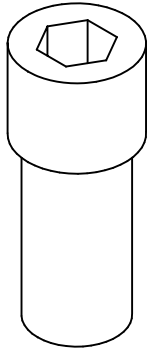

M8 x 16mm x 4

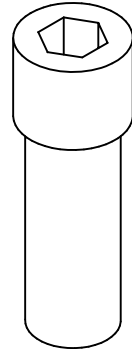

M8 x 20mm x 14

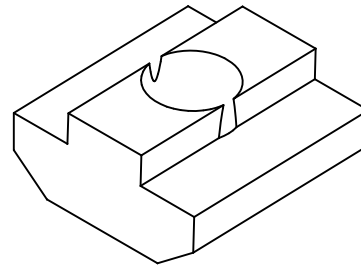

M8 x 4

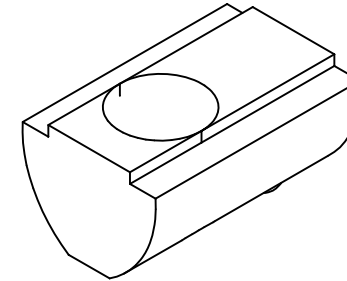

M8 x 18

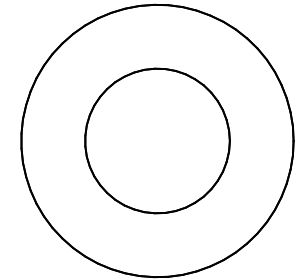

x 14

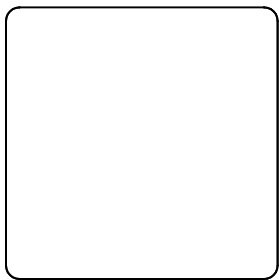

4040 x 4

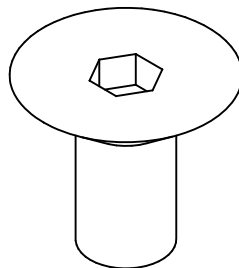

M8 x 16mm x 4

# Fasteners Pack

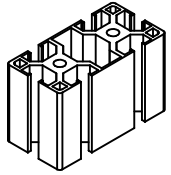

420mm x 1

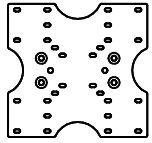

x 1

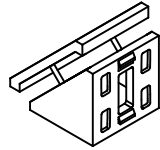

x 2



M8 x 16mm x 4

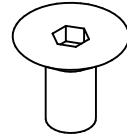

M8 x 16mm x 4

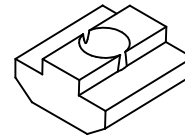

x 4

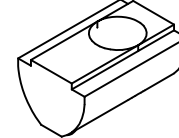

x 4

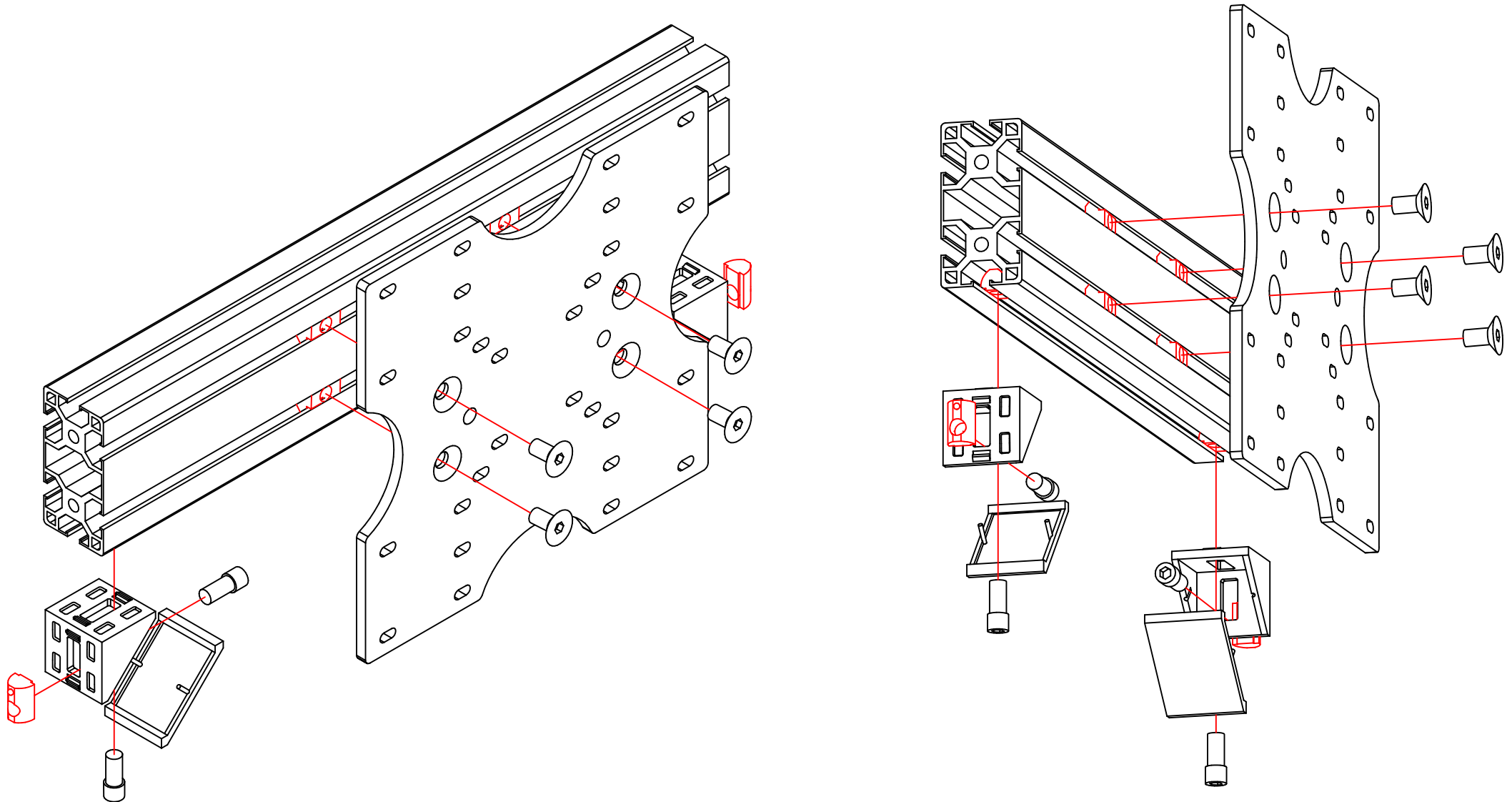

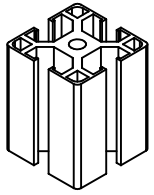

420mm x 1

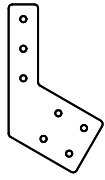

x 1

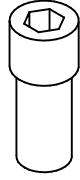

M8 x 20mm x  
14

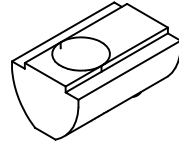

M8 x 14

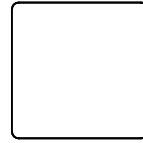

x 4

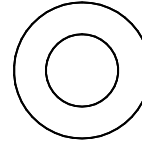

x 14

# Structure Fasteners Pack

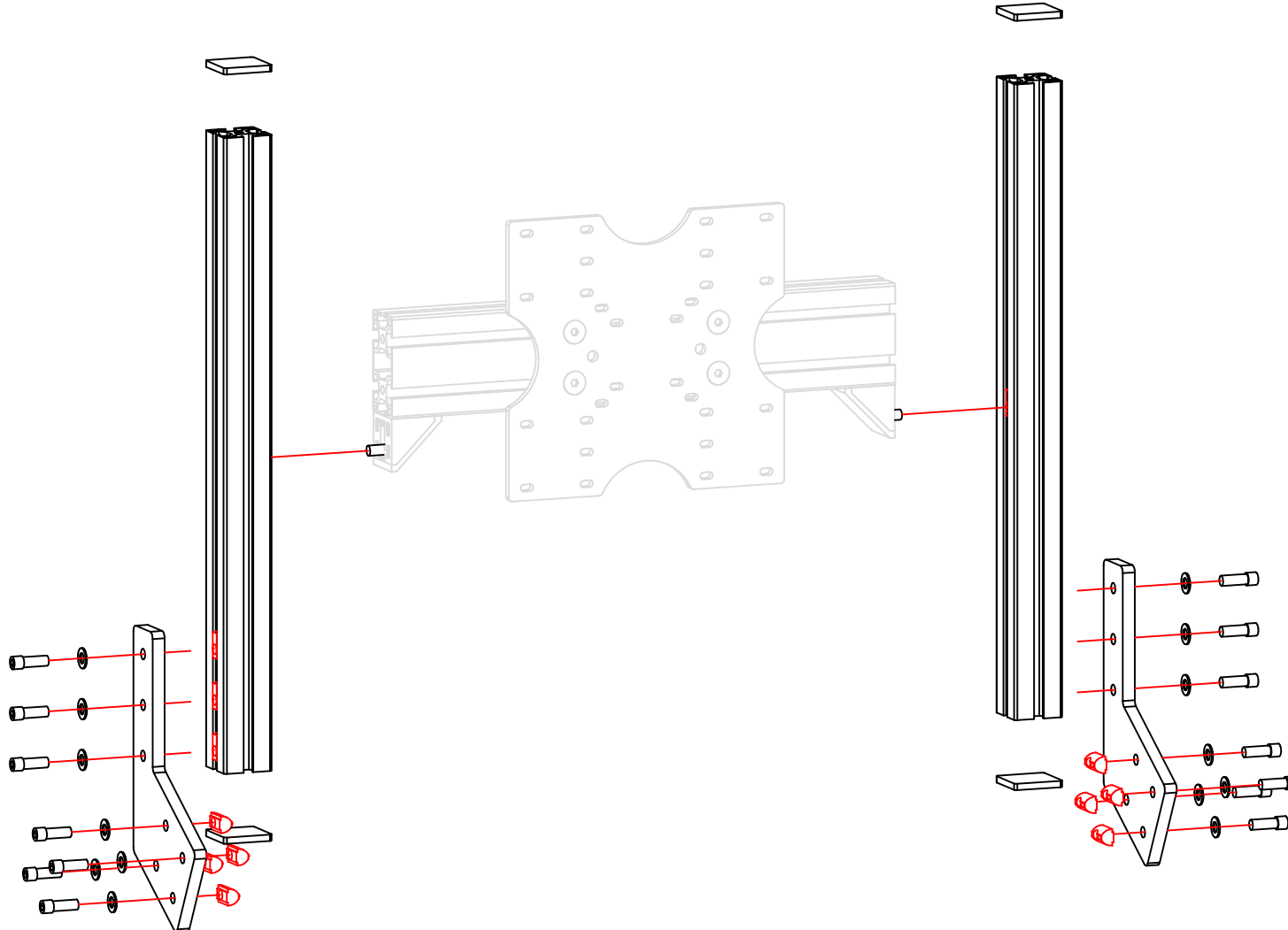

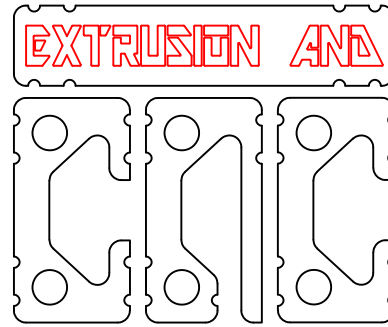

If you still have some questions regarding assembly of this product or about the manual itself, please refer to our support department. They can be reached at

[support@extrusionandcnc.com](mailto:support@extrusionandcnc.com)

whatsapp: +971506580398