

09 Monitor Stand

Instruction manual

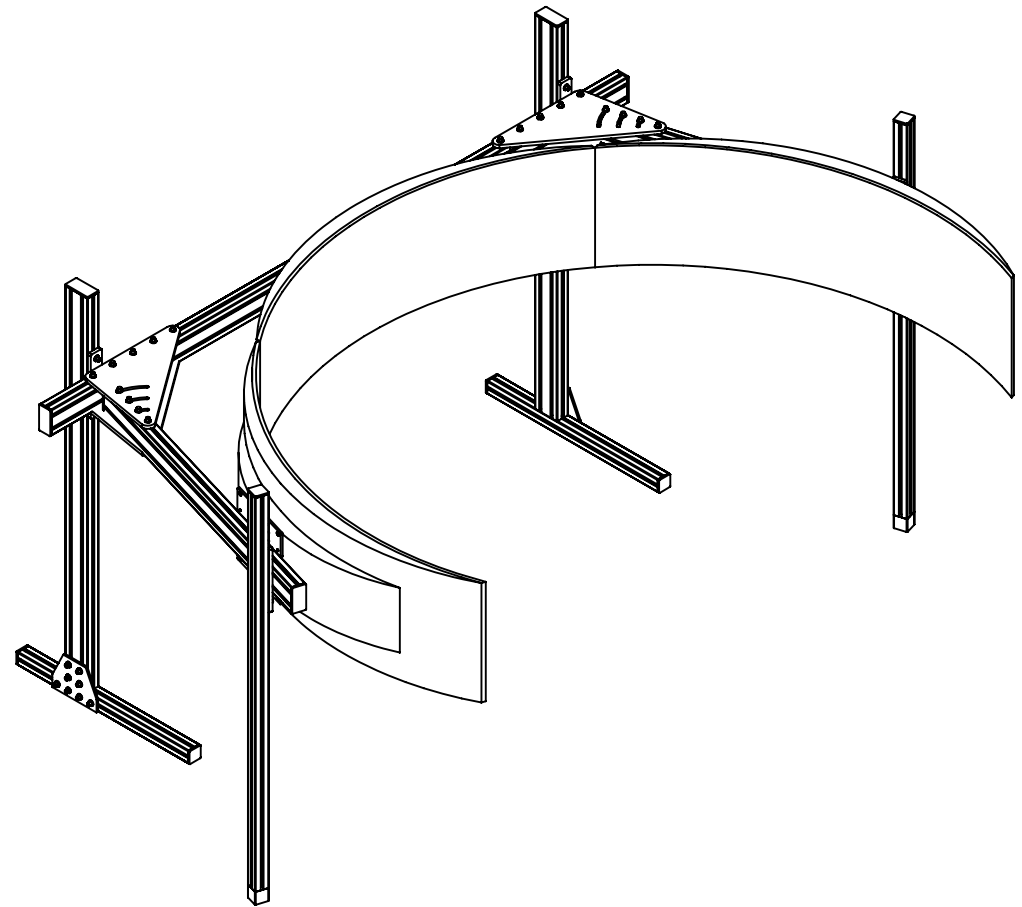

Package Includes

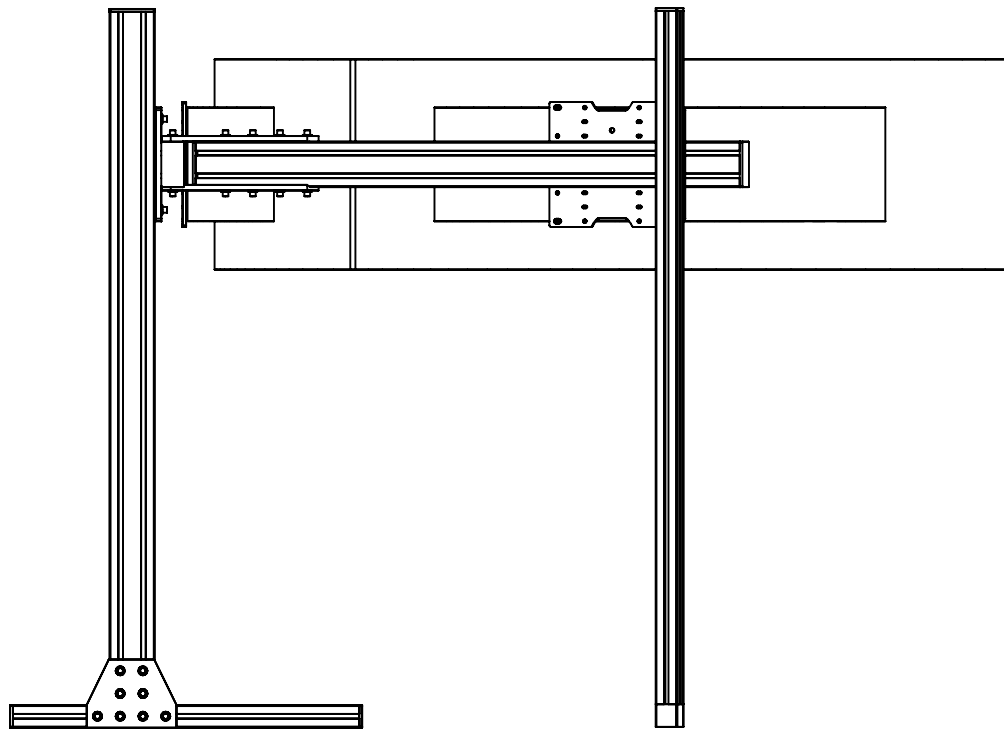
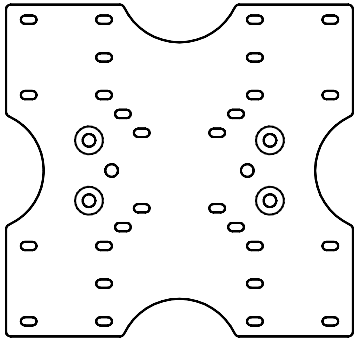

x 3

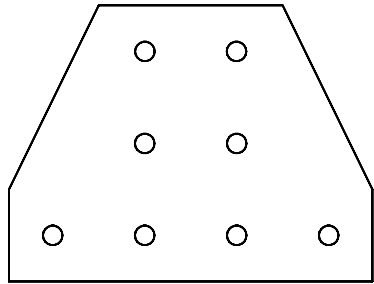

x 2

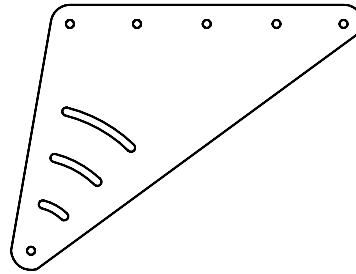

x 4

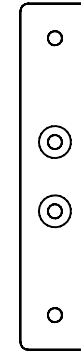

x 2

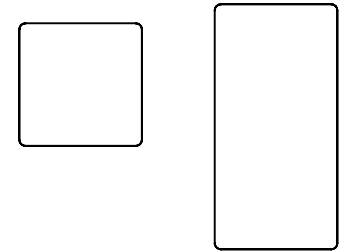

4040 x 6 / 4080 x 8

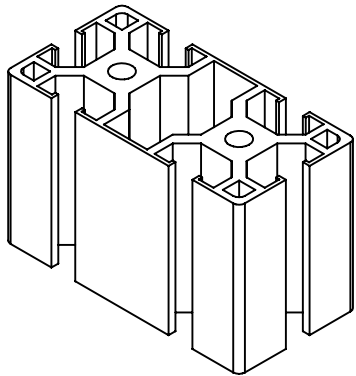

1220mm x 5

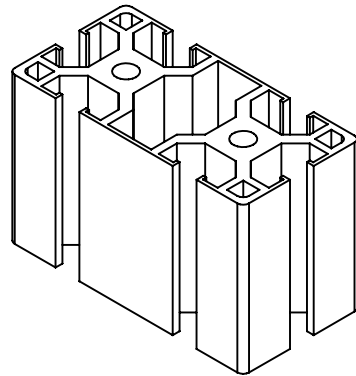

420mm x 2

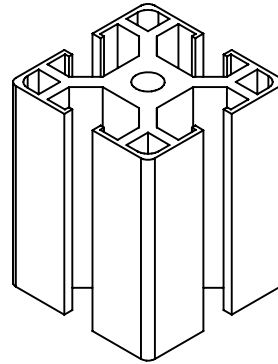

1220mm x 2

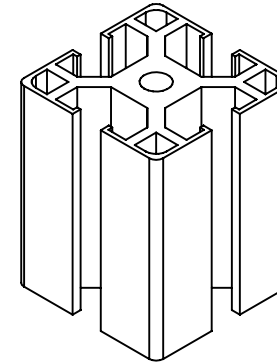

610mm x 2

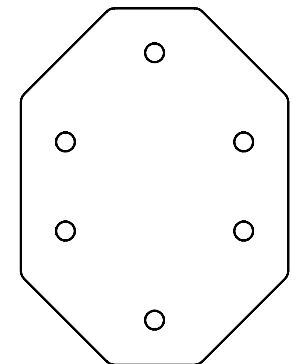

Optional x 2

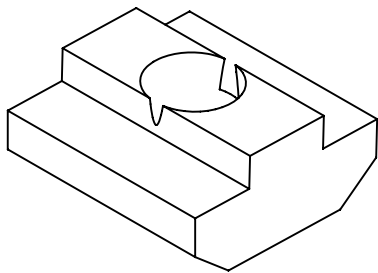

M8 x 80

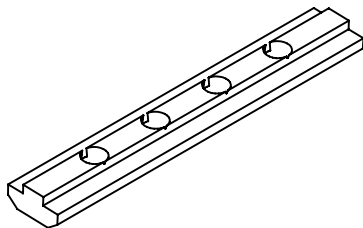

M6 x 8



M8 x 20mm x 44

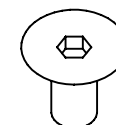

M8 x 20mm x 16

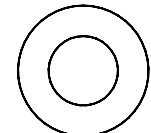

x 60



M8 x 16mm x 16

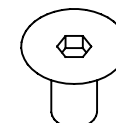

M8 x 16mm x 4

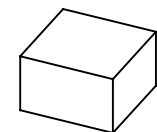

x 2

Pivot Fasteners Pack

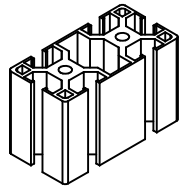

1220mm x 2

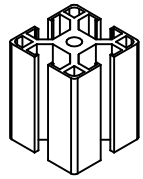

610mm x 2

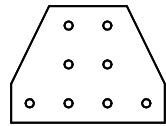

x 2

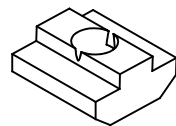

M8 x 16



M8 x 16mm x
16

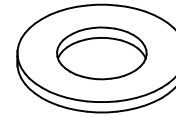

x 16

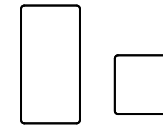

4080 x 4 / 4040
x4

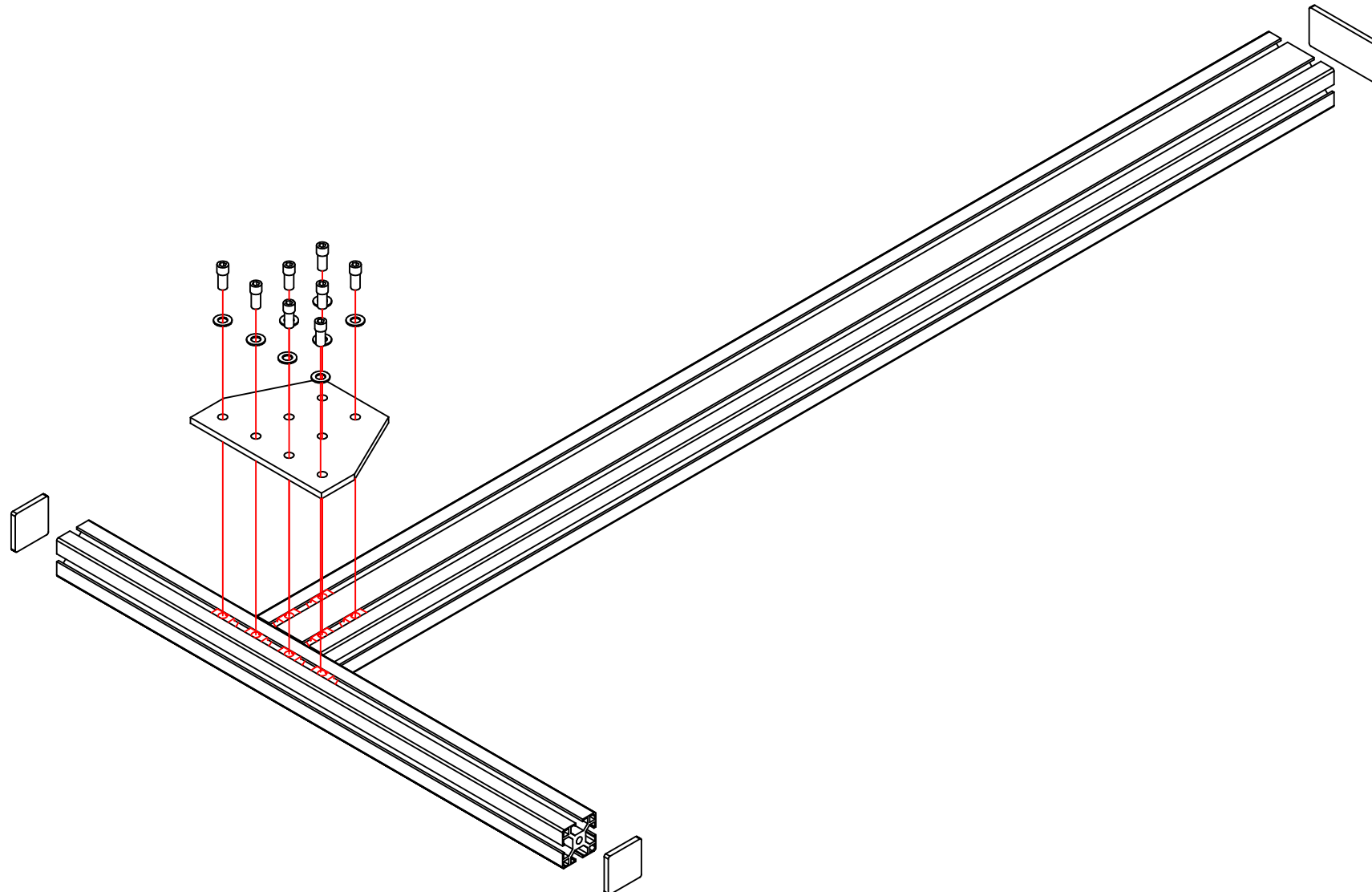

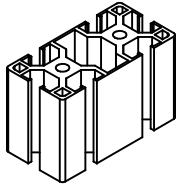

1220mm x 2

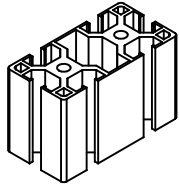

420mm x 2

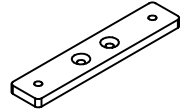

x 2

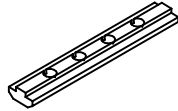

M6 x 8

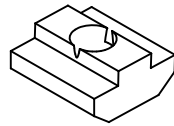

M8 x 12



M8 x 20mm x
4

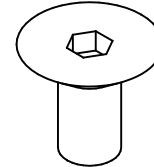

M8 X16mm x 8

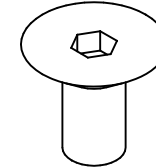

M8 x 20mm x
4

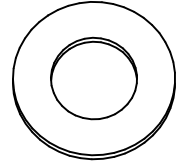

x 4



4080 x 2

Pivot Fasteners Pack and Vesa Pack

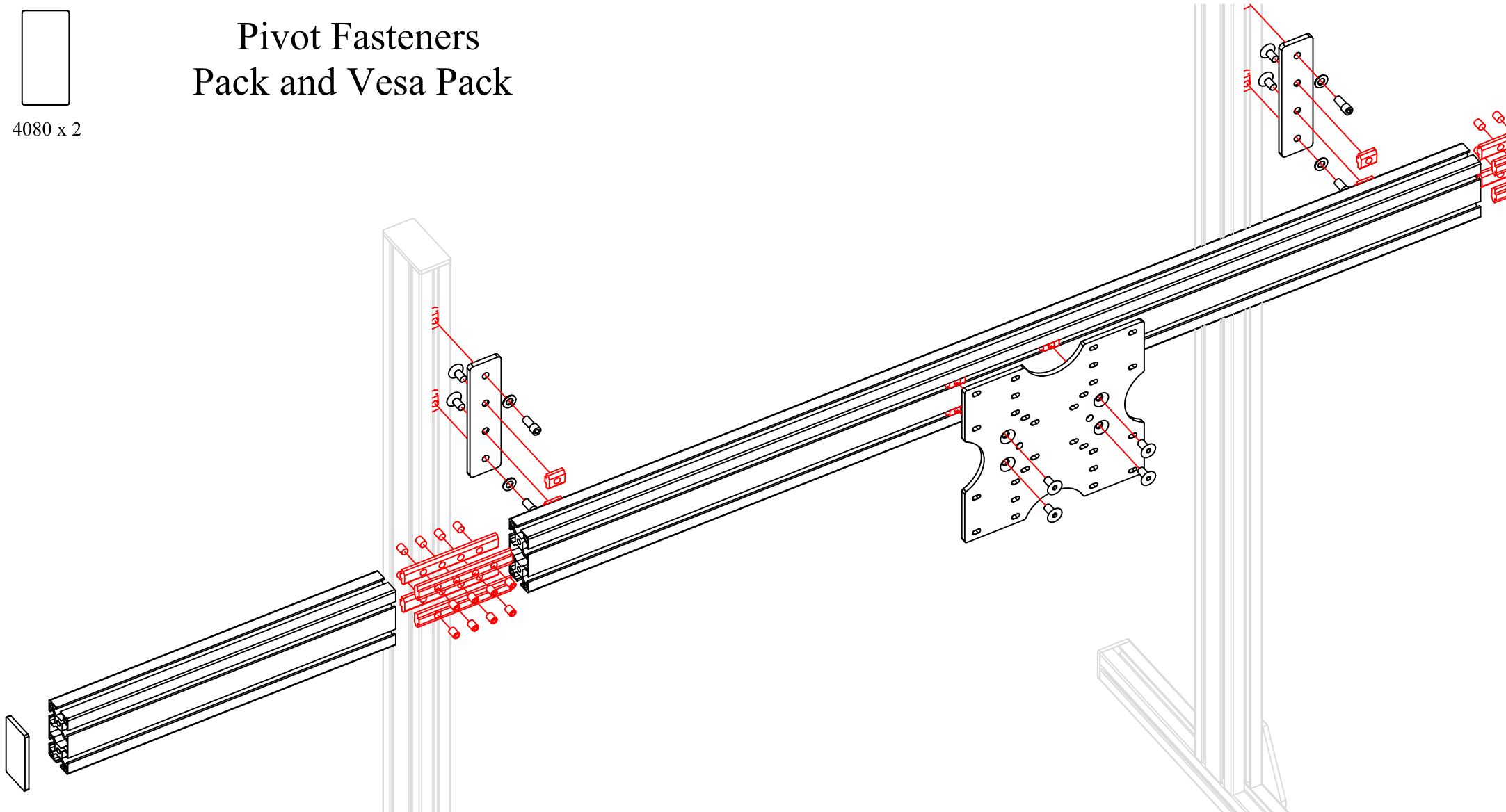

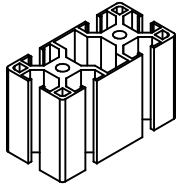

1220mm x 2

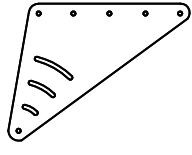

x 4



M8 x 20mm x
36

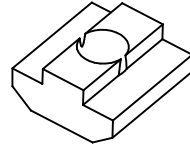

M8 x 36

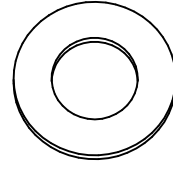

x 36

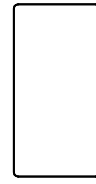

4080 x 4

Pivot Fasteners Pack

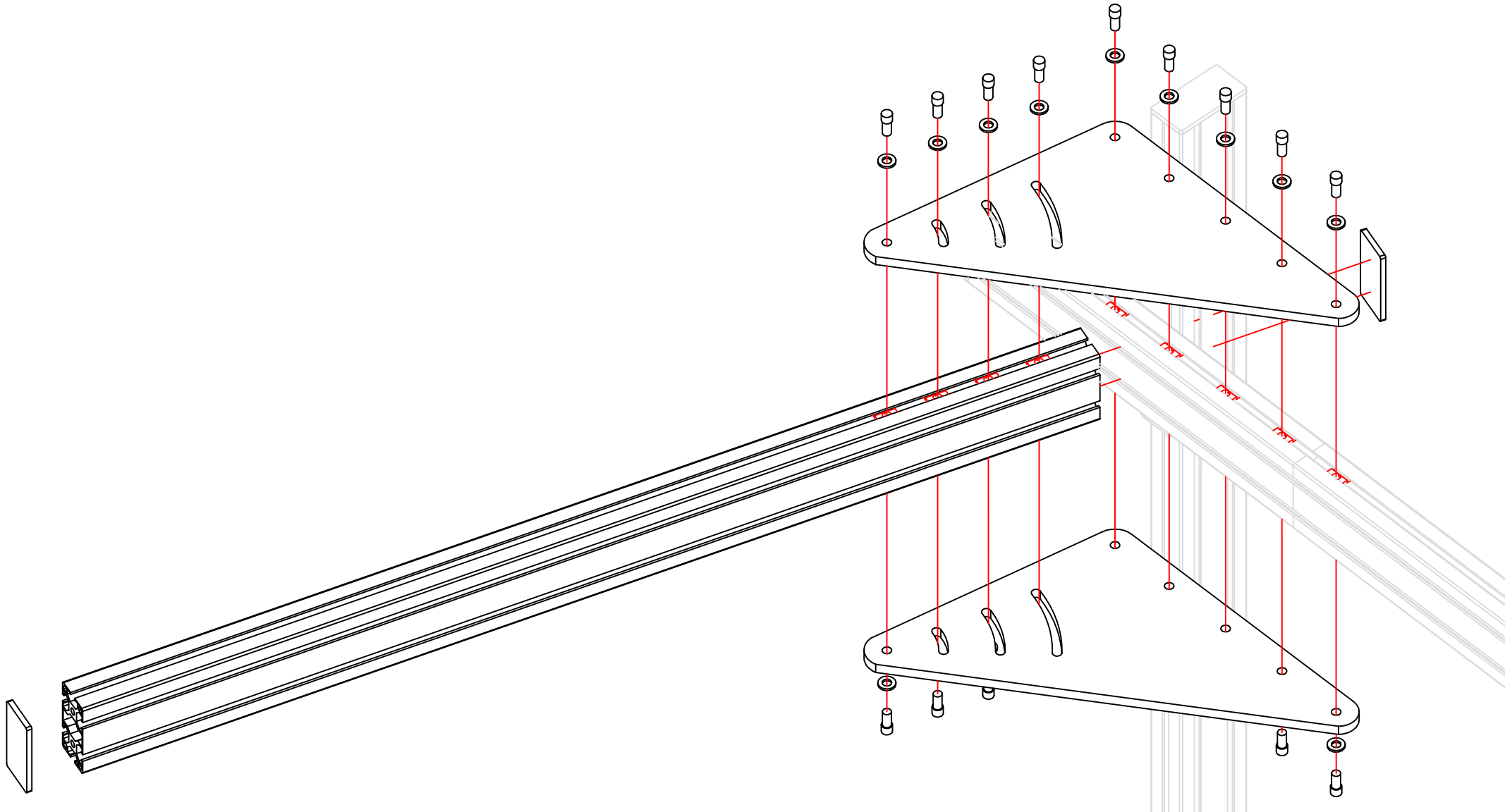

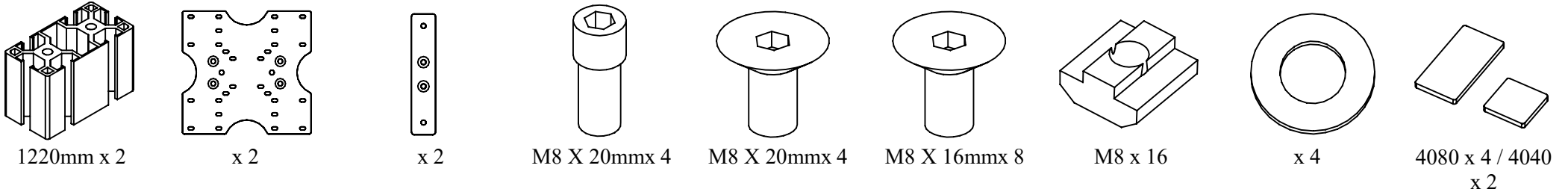

Pivot Fasteners Pack and Vesa Pack

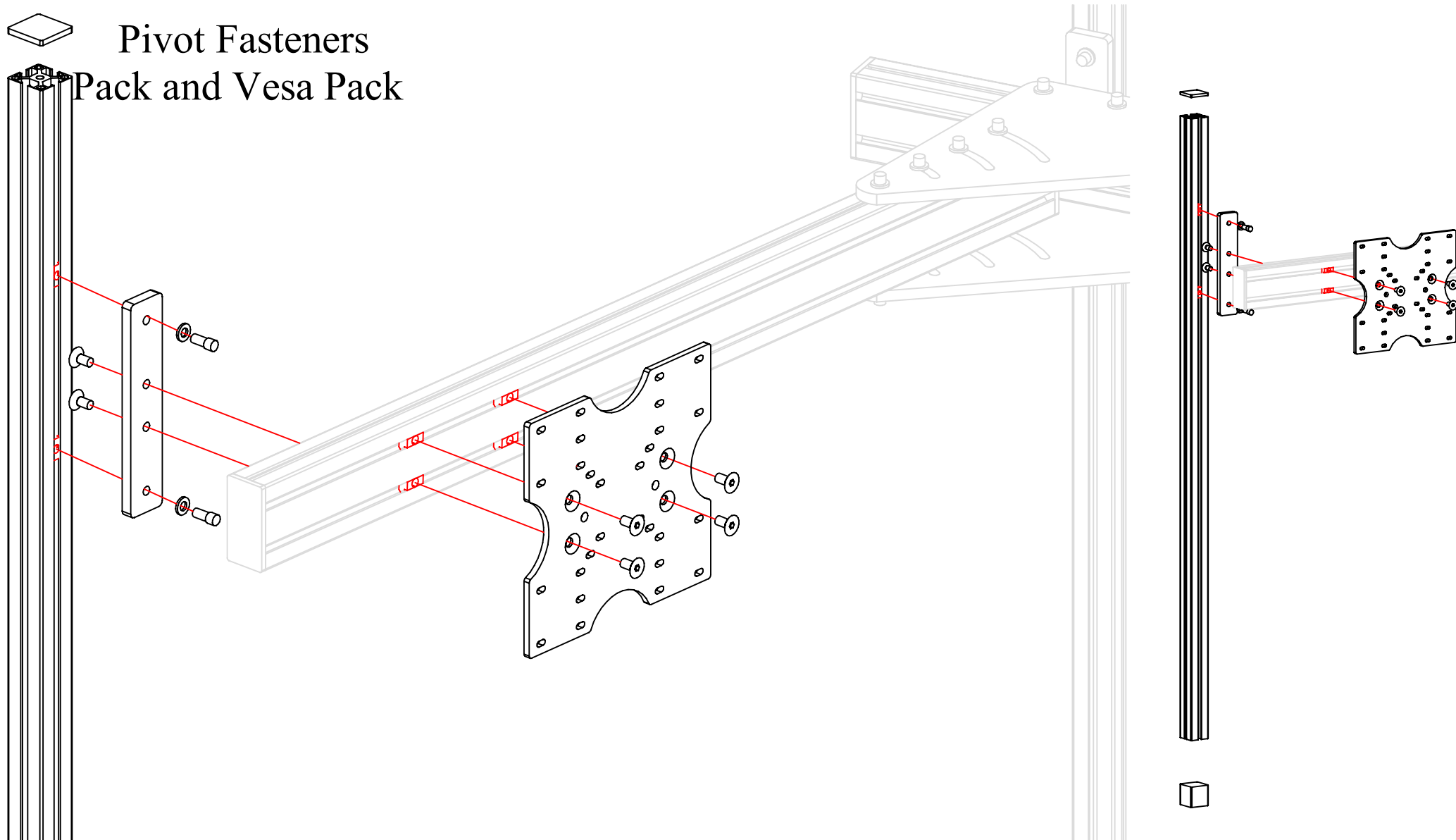

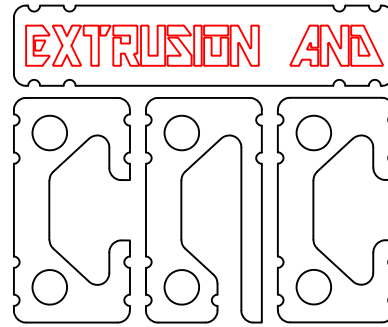

If you still have some questions regarding assembly of this product or about the manual itself, please refer to our support department. They can be reached at

support@extrusionandcnc.com

whatsapp: +971506580398