

6" LED DISK LIGHT

ULTRA THIN TRIM DESIGN

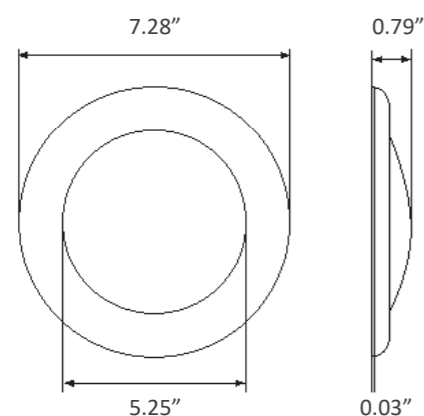

Weight 240g
Dimensions 7.28" x 7.28" x 0.79"

The Parmida LED Technologies™ 6 inch LED Disk Light is an industry shifting, truly ultra-thin fixture. The 0.03 inch thin Disk Light features as the ideal flush mount look, engineered for easy installation in any 5" or 6" downlight housing and any 3", 4" or 5" Junction Box. This product is built with Steady-Dim technology and is compatible with most modern dimmers.











DISK LIGHT



PRODUCT SPECIFICATIONS

Item Number	PLED-DISK5/615W2700K-DIM	PLED-DISK5/615W3000K-DIM	PLED-DISK5/615W4000K-DIM	PLED-DISK5/615W5000K-DIM
Wattage	15W	15W	15W	15W
Lumens	1050lm	1050lm	1050lm	1050lm
Voltage	120V AC	120V AC	120V AC	120V AC
Equivalent	120W	120W	120W	120W
Beam Angle	120°	120°	120°	120°
Dimmable	Yes	Yes	Yes	Yes
Material	Aluminium	Aluminium	Aluminium	Aluminium
CCT	2700K, Warm White	3000K, Soft White	4000K, Cool White	5000K, Day Light
CRI	>90	>90	>90	>90
LED Driver Type	DOB (Driver on Board)	DOB (Driver on Board)	DOB (Driver on Board)	DOB (Driver on Board)
Base type	E26	E26	E26	E26
Life	50,000 Hours	50,000 Hours	50,000 Hours	50,000 Hours
Effeciency	88%	88%	88%	88%
Certification	ES, ETL, FCC	ES, ETL, FCC	ES, ETL, FCC	ES, ETL, FCC
Warranty	5 Years	5 Years	5 Years	5 Years

- 
50,000 HOURS
- 
DAMP LOCATION RATED
- 
120V AC VOLTAGE
- 
1050 LUMENS
- 
120 WATT REPLACEMENT
- 
120° BEAM ANGLE
- 
INSTANT ON
- 
NO HUMMING/BUZZING