

SINGLE HEAD

LED SECURITY LIGHT SOLAR POWERED

MOTION SENSOR OPERATED | DUSK TO DAWN | ADJUSTABLE HEAD

PRODUCT DETAILS

MODEL NO.: PLED-SLP500LM-SH-SOL-BL , PLED-SLP500LM-SH-SOL-W

5WATT, 500LM, 5000K, 3.7V

POWERED BY
SOLAR PANEL

ADDITIONAL POWER OPTION
DRY BATTERY

SENSING RANGE
26FT - 40FT

LIGHT ON-TIME
10SEC - 60SEC

PRODUCT DIMENSIONS

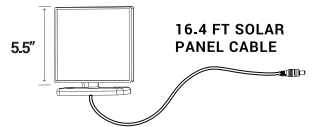
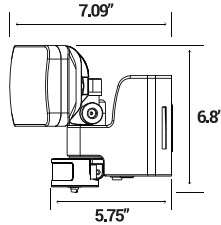
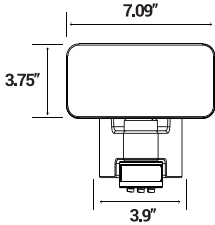

SAFETY INFORMATION

- Ensure the switch is turned on.
- Other nearby light sources can cause the light to flicker or even prevent it from operating.
- Check there are no breaks in the wiring, and that all connections are secure.
- Ensure the installed batteries are charged, and replace or charge to full capacity in a Lithium battery charger (must be purchased separately).
- Do not position the light unit near a source of heat as this can damage the battery
- Do not mount the light or solar panel to unstable surfaces.
- Do not stare directly at the light while it is illuminated.
- Do not leave the cable trailing as this could pose a trip hazard.

INSTALLATION

For best results, position the solar panel in a location where it will receive maximum sunlight. Ideally, the location should be free from cover or shade. You should avoid positioning the light near other light sources, as this may cause the lights to flicker.

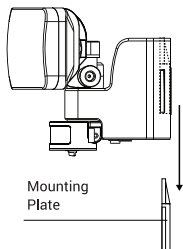

STEP 1

Slide the mounting plate off the back of the light.

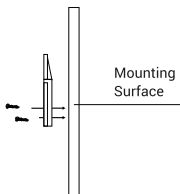

STEP 2

Mount it to the desired wall or surface using screws.

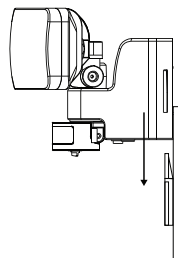

STEP 3

Slide the light back on to the mounting plate. The light is now in place.

OPERATION

Press the **ON/OFF Switch** in order to turn the light on.

The light will activate at 1000 lumens once motion is detected for the desired duration — see 'TIME' instructions below.

Press again to turn off. The light will remain off and not detect any movement.

ADJUSTING THE LIGHT

On the bottom of the motion sensor unit there are 3 dials:

SENS (sensitivity to motion) — this determines the range of the motion detector. Rotating the dial clockwise will increase the sensor range to a maximum of 40ft and a 120° angle.

TIME — the duration the light stays on after motion has been detected. This can be adjusted so the light will remain on from 10 seconds up to 60 seconds when the motion sensor is activated. Rotating the dial clockwise will extend the time the light is illuminated.

LUX (sensitivity to light) — this determines the level of ambient light reached before the light turns on. If set to the maximum, the sensor will trigger in most situations ranging from dusk to daylight. If set to the minimum, the sensor will only activate from Dusk To Dawn— this is the ideal setting for general evening and nighttime.

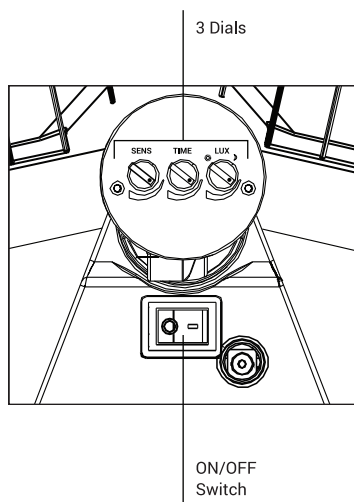

TO CHARGE

1. Screw the solar panel into the desired wall or surface.
2. Connect the panel to the light using the provided cable.

Other charging methods:

- The Lithium Ion batteries may be charged in a lithium ion battery charger (must be purchased separately).
- Alternatively, you can purchase alkaline dry batteries and install via the alkaline battery compartment.

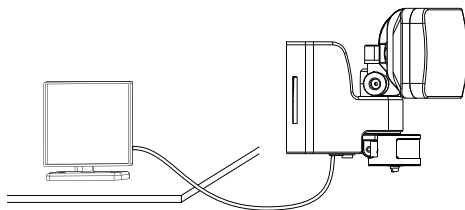

* For best results, leave the light on to charge in direct sunlight for three days. This allows the solar panel's batteries to reach full capacity.

If the solar panel gets dirty, its charging capacity will be reduced. Clean as required with a damp cloth - avoid harsh detergents or solvents as these can damage the panel.

If the rechargeable battery loses its charge, the fixture will rely on the alkaline dry battery for power (if dry batteries are in place).

*WARNING: MAKE SURE A LITHIUM BATTERY CHARGER IS USED AS OTHER CHARGERS MAY NOT BE COMPATIBLE AND COULD BE A SAFETY RISK.

TO INSERT/CHANGE BATTERIES

Replacing the Alkaline Batteries

1. Turn the two dials and push the plate down and out (from the top) to pull the cover open.
2. Replace the batteries and close the plate.
3. Turn the two dials clockwise so the battery cover is secure.

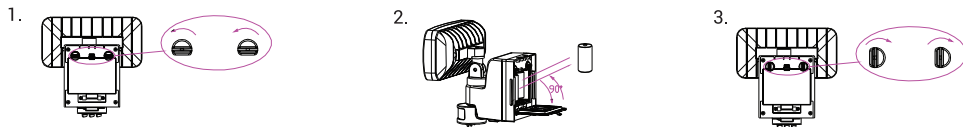

Replacing the Rechargeable Battery

1. Unscrew the screws underneath and above the hinge of the mounting plate.
2. Press the push plate above the bottom plate and remove the lamp body (The rechargeable lithium ion battery is under the space for the dry batteries)
3. Push the mounting plate back and screw the screws to their place.

