

VELA

TYPOGRAPHY

RP-E-21

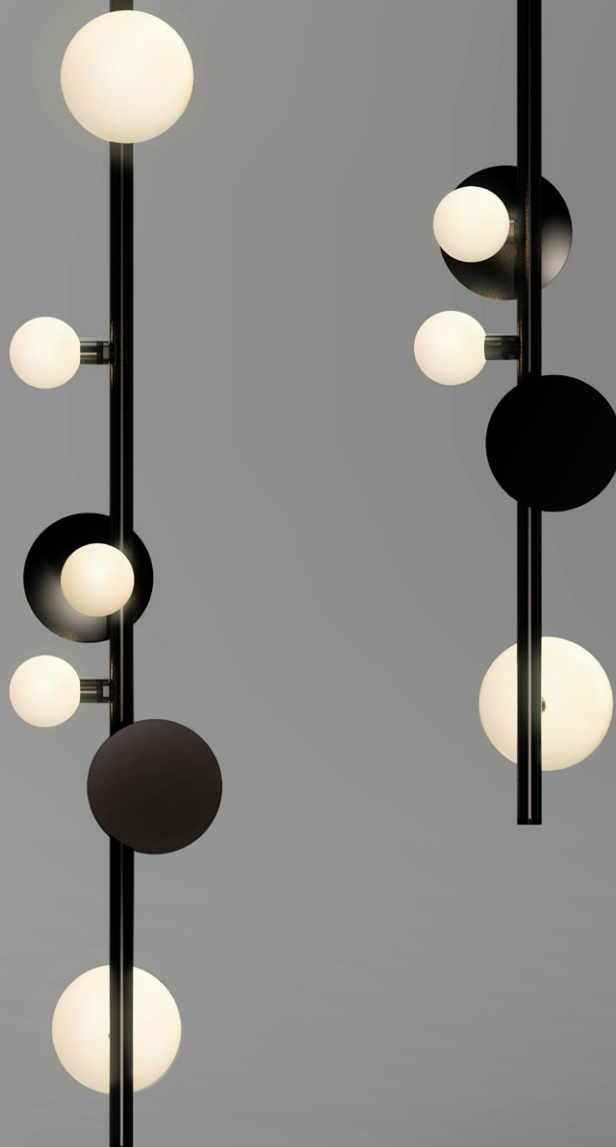

WWW.RAKUMBA.COM
SALES@RAKUMBA.COM

ALL RIGHTS RESERVED © RAKUMBA, 2021

Rakumba



TYPOGRAPHY VELA

PENDANT E



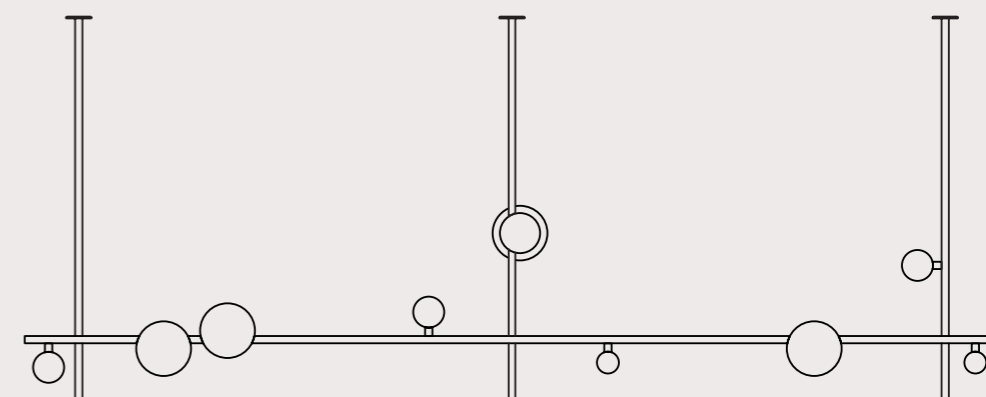

TYPOGRAPHY VELA

RP-E-21

Named for the VELA constellation, this new family of spherically formed luminaires suggesting celestial bodies interprets the TypoGRAPHY rail as the axis of an orbital space. The distinctive plate feature alludes to the occlusion and shadowing created during eclipses, changing as the viewer moves about space.

This interplay of light and shadow is a fundamental aspect of TypoGRAPHY VELA. Bringing drama through Calder-evoking sculpture - either minimalist or extravagant - VELA invites designers to exercise

creativity using the incredibly versatile TypoGRAPHY system as the backbone. A palette of black, golden, and De Stijl inspired colourways allow for every installation to stand as a unique artistic piece.

VELA: captivating constellations of light and shadow.



“In the Typography system, lights attach to the rail in all dimensions. Visually, this works similarly to the way planets orbit the sun. This translates perfectly to Vela, which evokes feelings of constellations, of orbiting planets.”

————— Studio Truly Truly







“We experiment with geometric shapes that distort the viewer’s perception, creating constellations which, although static, give the impression of movement.”

————— Studio Truly Truly



The element of 'light' itself is interesting because there's the glow, the reflection, shadows, the intensity, the warmth. Crafting with light is fascinating because it's a really playful 'ingredient' - a crucial part of the mystery.

————— Studio Truly Truly



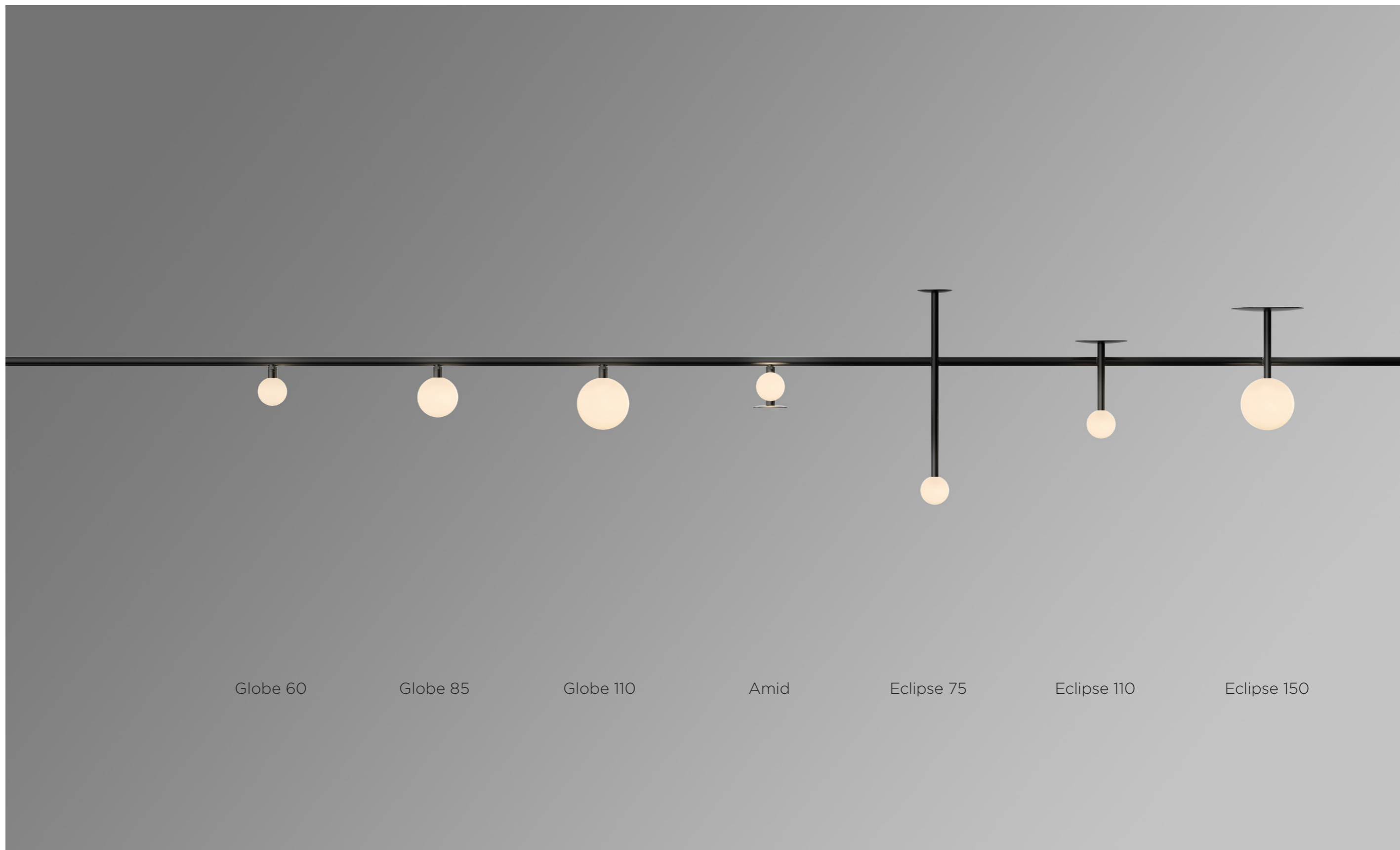

Globe 60

Globe 85

Globe 110

Amid

Eclipse 75

Eclipse 110

Eclipse 150

VELA RAIL LIGHT



Globe 60 Sconce
Globe 85 Sconce
Globe 110 Sconce

Globe 60 Plate Sconce
Globe 85 Plate Sconce
Globe 110 Plate Sconce

Eclipse 75 Sconce

Eclipse 110 Sconce
Amid Sconce

VELA WALL SCONCE



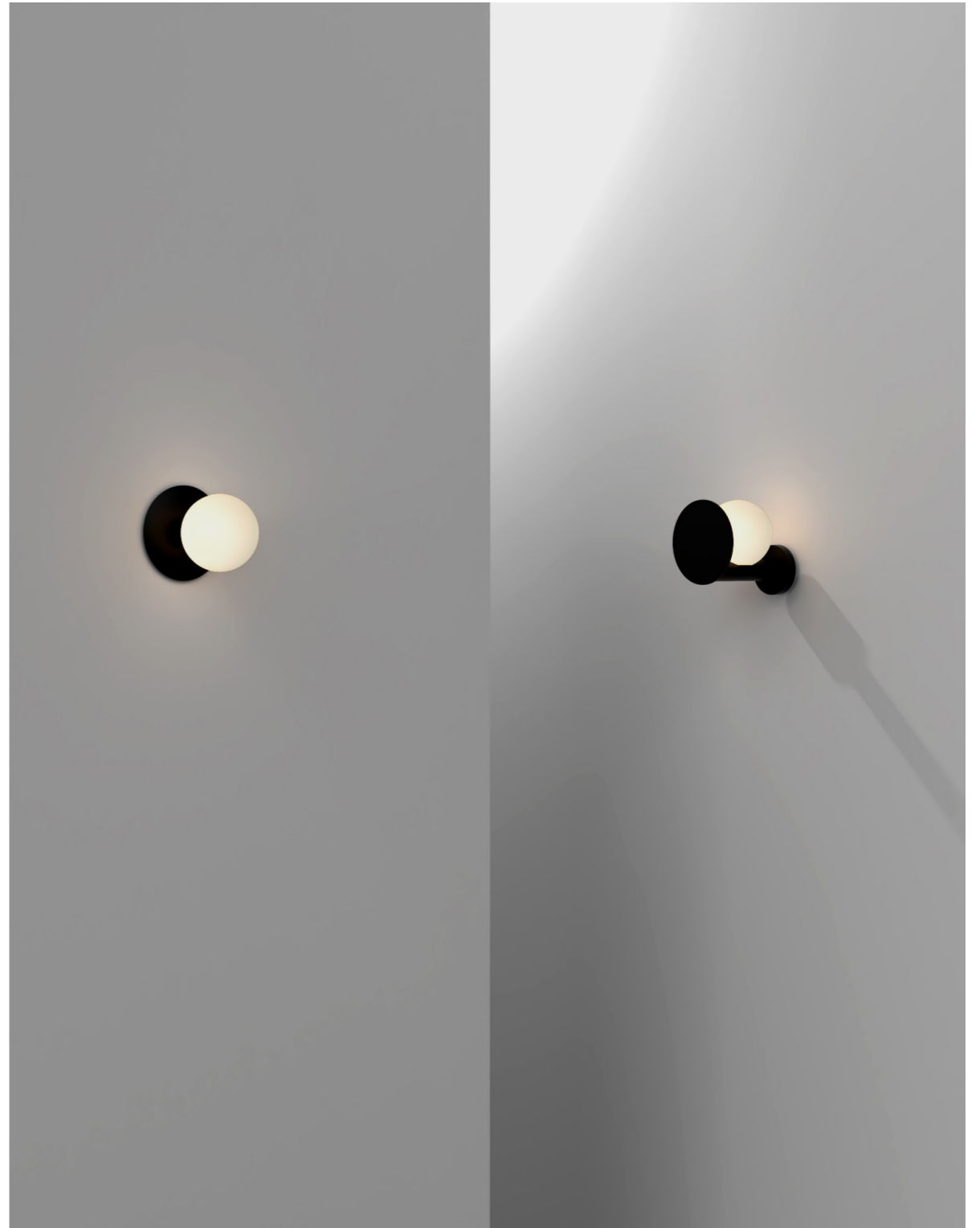



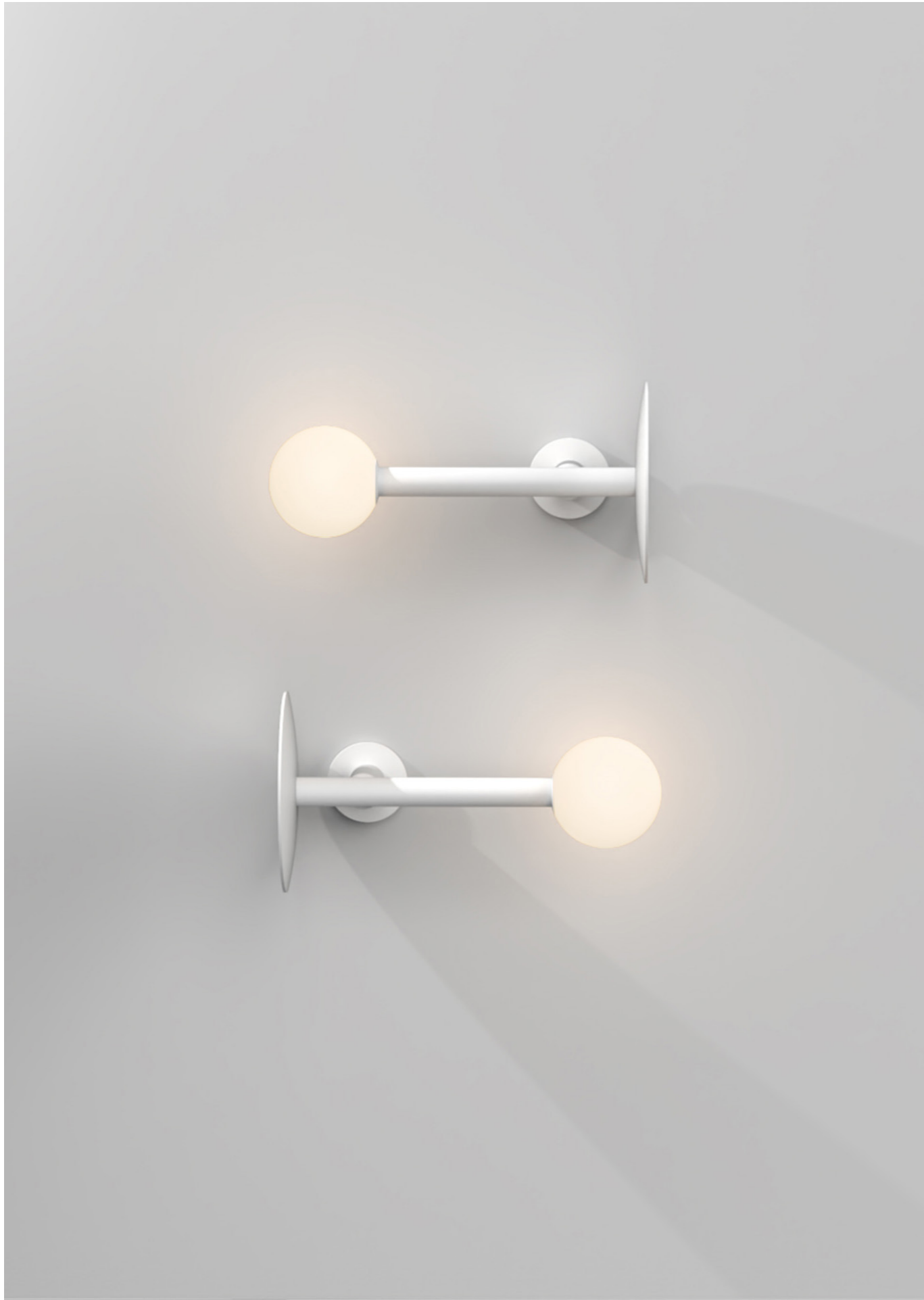

MATERIALS & FINISHES

STEM

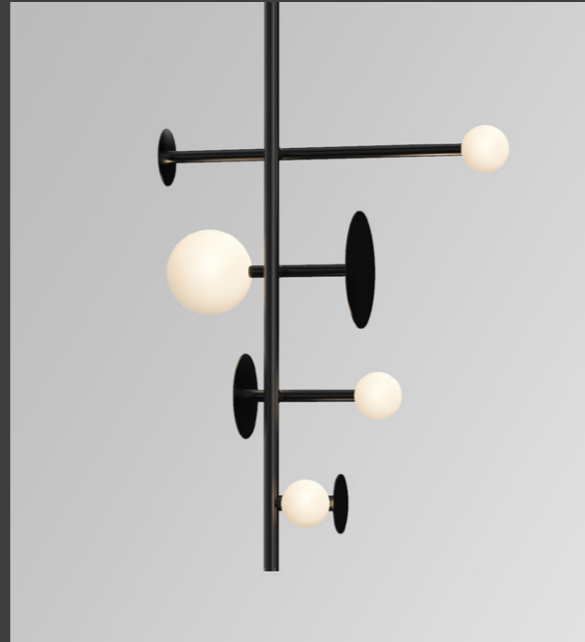

BLACK ANODISED

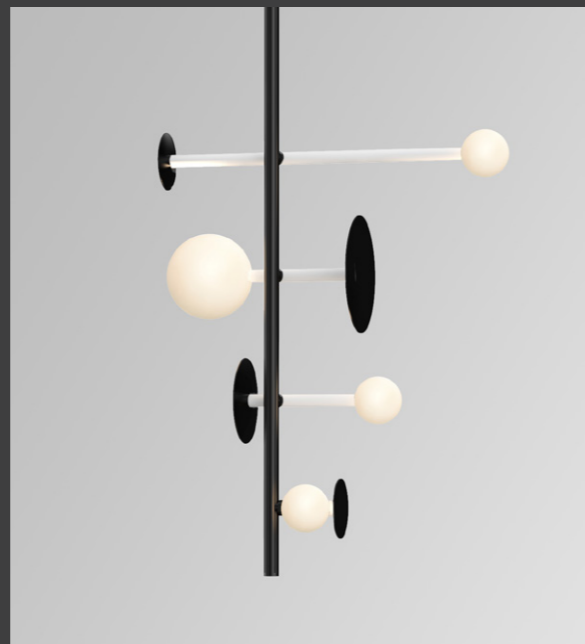

WHITE

PLATE

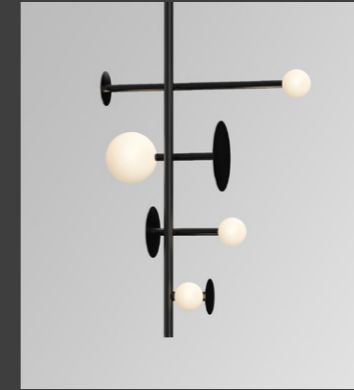

BLACK ANODISED

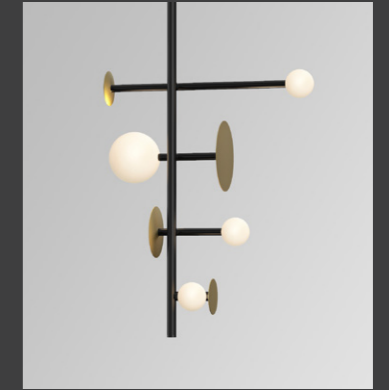

GOLDEN ANODISED

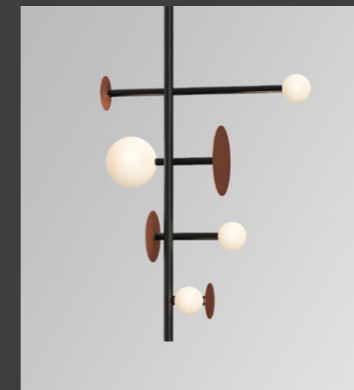

RED

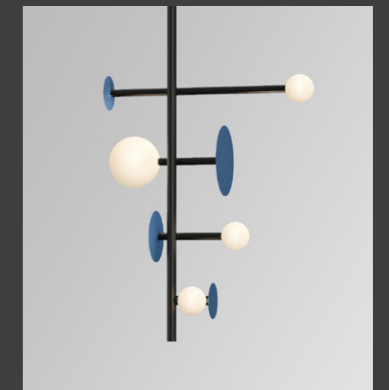

BLUE

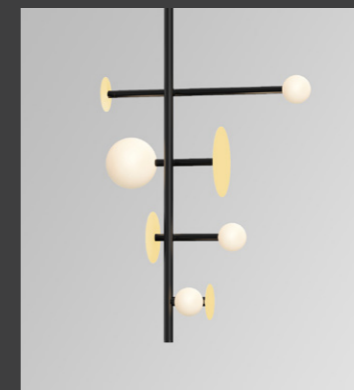

YELLOW

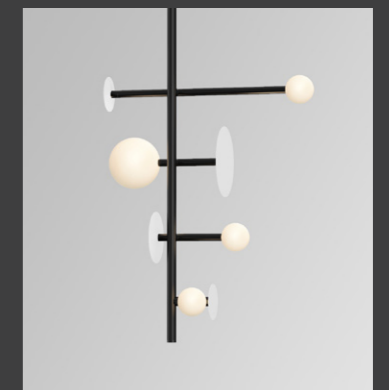

WHITE

CUSTOM COLOURS AVAILABLE

“A visual dance happens with the addition of the discs that are parallel to the light but perpendicular to the rail. Together with the illuminated spheres, they can be seen to reveal the image of all the phases of the moon - from eclipse to waning crescent.”

————— Studio Truly Truly

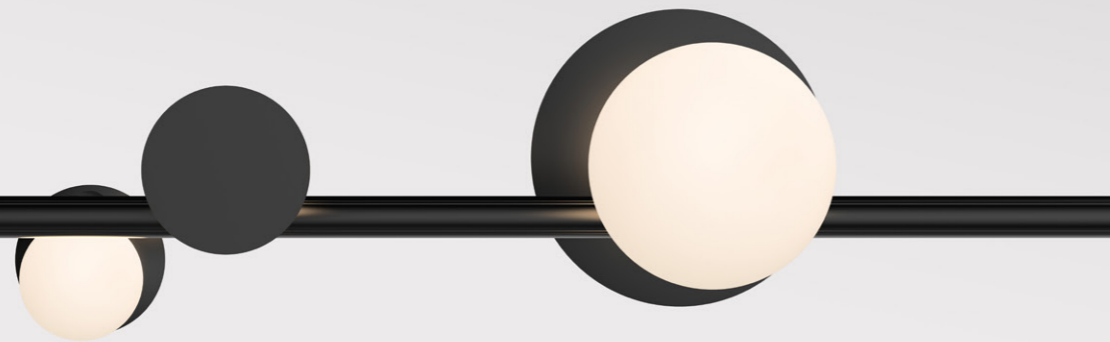

OPTIONS

RAIL SYSTEM

RAIL LENGTH	<input type="radio"/>	150MM	<input type="radio"/>	500MM
	<input type="radio"/>	750MM	<input type="radio"/>	1000MM
	<input type="radio"/>	1200MM	<input type="radio"/>	1500MM
	<input type="radio"/>	1800MM	<input type="radio"/>	2000MM
	<input type="radio"/>	2500MM	<input type="radio"/>	2800MM
	<input type="radio"/>	CUSTOM (MAX 2800MM)		

FINISH	<input type="radio"/>	BLACK
--------	-----------------------	-------

MOUNT	<input type="radio"/>	CEILING MOUNT	<input type="radio"/>	CANOPY
	<input type="radio"/>	WALL MOUNT	<input type="radio"/>	(FOR CONCRETE
	<input type="radio"/>	COUNTER TO CEILING	<input type="radio"/>	SUBSTRATE)
	<input type="radio"/>	WALL TO WALL		

DIMMING	<input type="radio"/>	NON DIMMABLE (REMOTE DRIVER)
	<input type="radio"/>	PHASE CUT/TRIAC (REMOTE DRIVER)
	<input type="radio"/>	DALI/SWITCH-DIM (REMOTE DRIVER)
	<input type="radio"/>	1-10V (REMOTE DRIVER)
	<input type="radio"/>	CASAMBI WIRELESS (REMOTE DRIVER)

LUMINAIRES

RAIL MODELS	<input type="radio"/>	GLOBE 60	<input type="radio"/>	ECLIPSE 75
	<input type="radio"/>	GLOBE 85	<input type="radio"/>	ECLIPSE 110
	<input type="radio"/>	GLOBE 110	<input type="radio"/>	ECLIPSE 150
	<input type="radio"/>	AMID		

WALL MODELS	<input type="radio"/>	GLOBE 60 SCONCE	<input type="radio"/>	GLOBE 110 PLATE SCONCE
	<input type="radio"/>	GLOBE 60 PLATE SCONCE	<input type="radio"/>	AMID SCONCE
	<input type="radio"/>	GLOBE 85 SCONCE	<input type="radio"/>	ECLIPSE 75 SCONCE
	<input type="radio"/>	GLOBE 85 PLATE SCONCE	<input type="radio"/>	ECLIPSE 110 SCONCE
	<input type="radio"/>	GLOBE 110 SCONCE		

STEM FINISH	<input type="radio"/>	BLACK ANODISED
	<input type="radio"/>	WHITE

PLATE FINISH	<input type="radio"/>	BLACK ANODISED
	<input type="radio"/>	GOLDEN ANODISED
	<input type="radio"/>	WHITE
	<input type="radio"/>	RED
	<input type="radio"/>	BLUE
	<input type="radio"/>	YELLOW
	<input type="radio"/>	CUSTOM

DIMENSIONS

ALL DIMENSIONS IN MILLIMETERS

RAIL LUMINAIRES

GLOBE 60
RP-E-2106

85

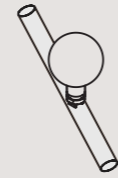
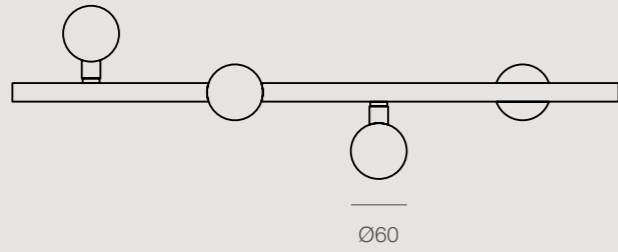

GLOBE 85
RP-E-2107

110

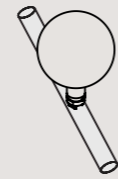
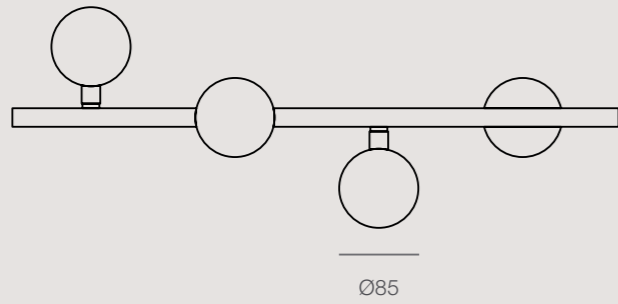

GLOBE 110
RP-E-2108

140

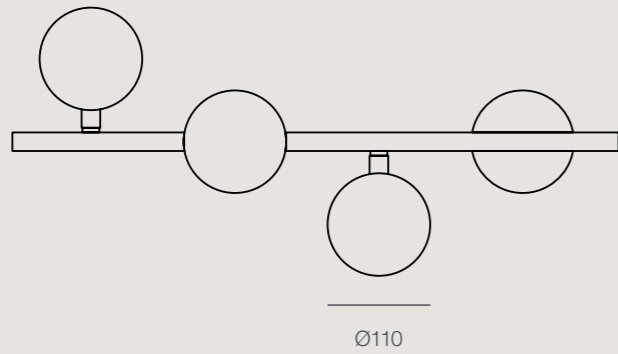

AMID
RP-E-2109

85

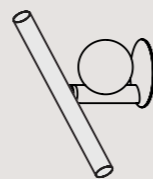
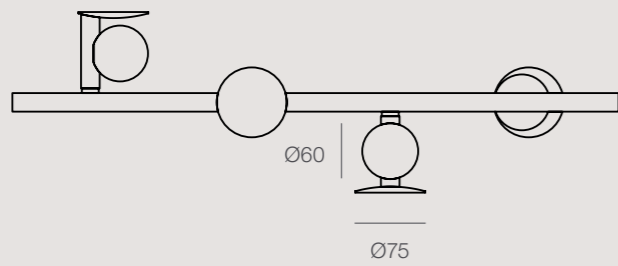

ECLIPSE 75
RP-E-2110

450

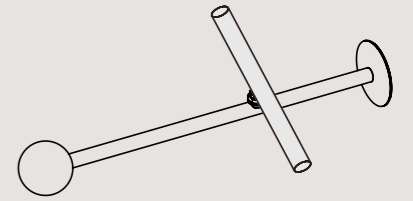
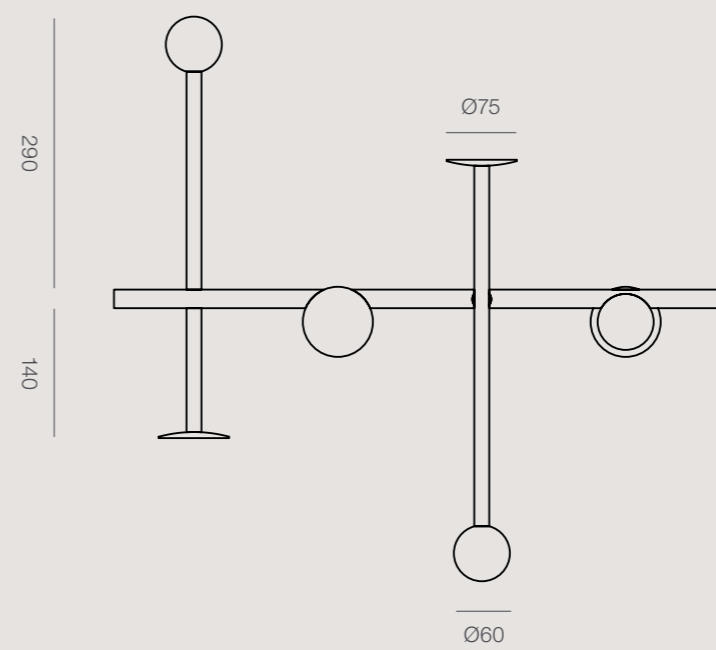

ECLIPSE 110
RP-E-2111

205

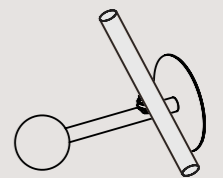
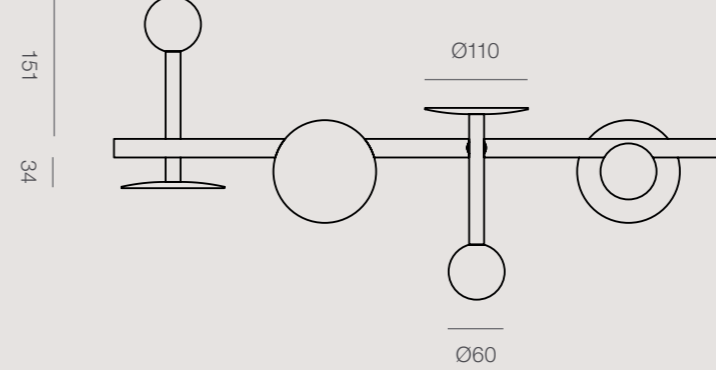

ECLIPSE 150
RP-E-2112

250

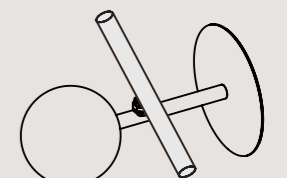
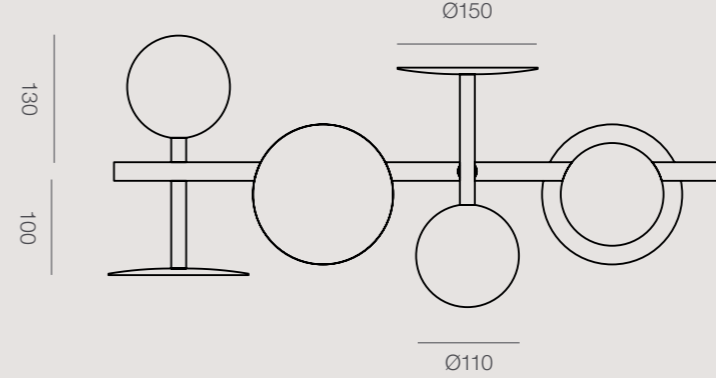

PENDANTS

CUSTOM COMPOSITIONS MAY BE CURATED
USING COMBINATION OF THE 7 VELA
LIGHTS IN ANY LOCATION

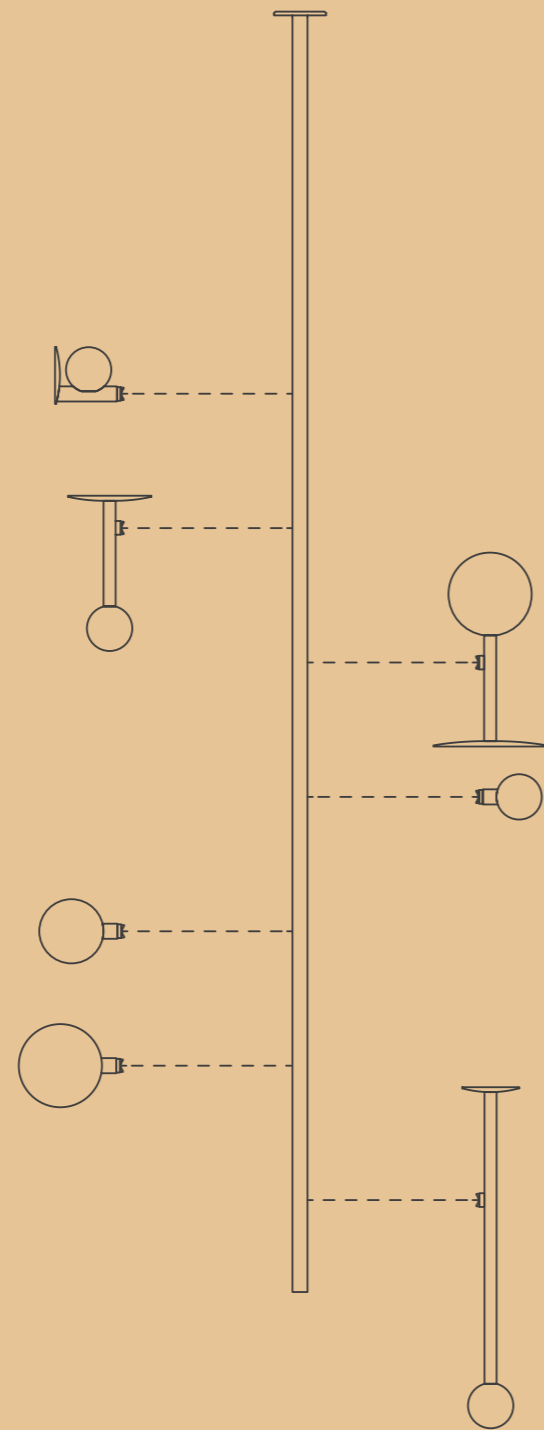

COMPOSITIONS

A



B



C

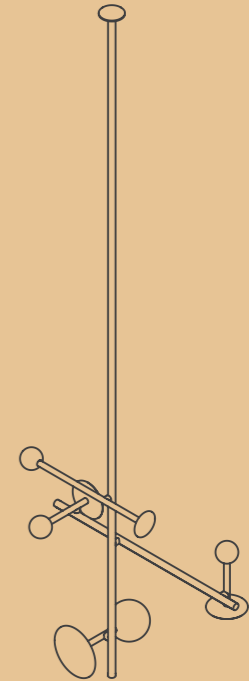

D



E

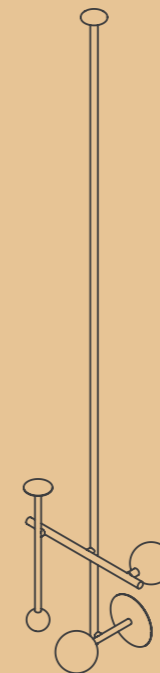

GANTRY

CUSTOM COMPOSITIONS MAY BE CURATED
USING COMBINATION OF THE 7 VELA
LIGHTS IN ANY LOCATION

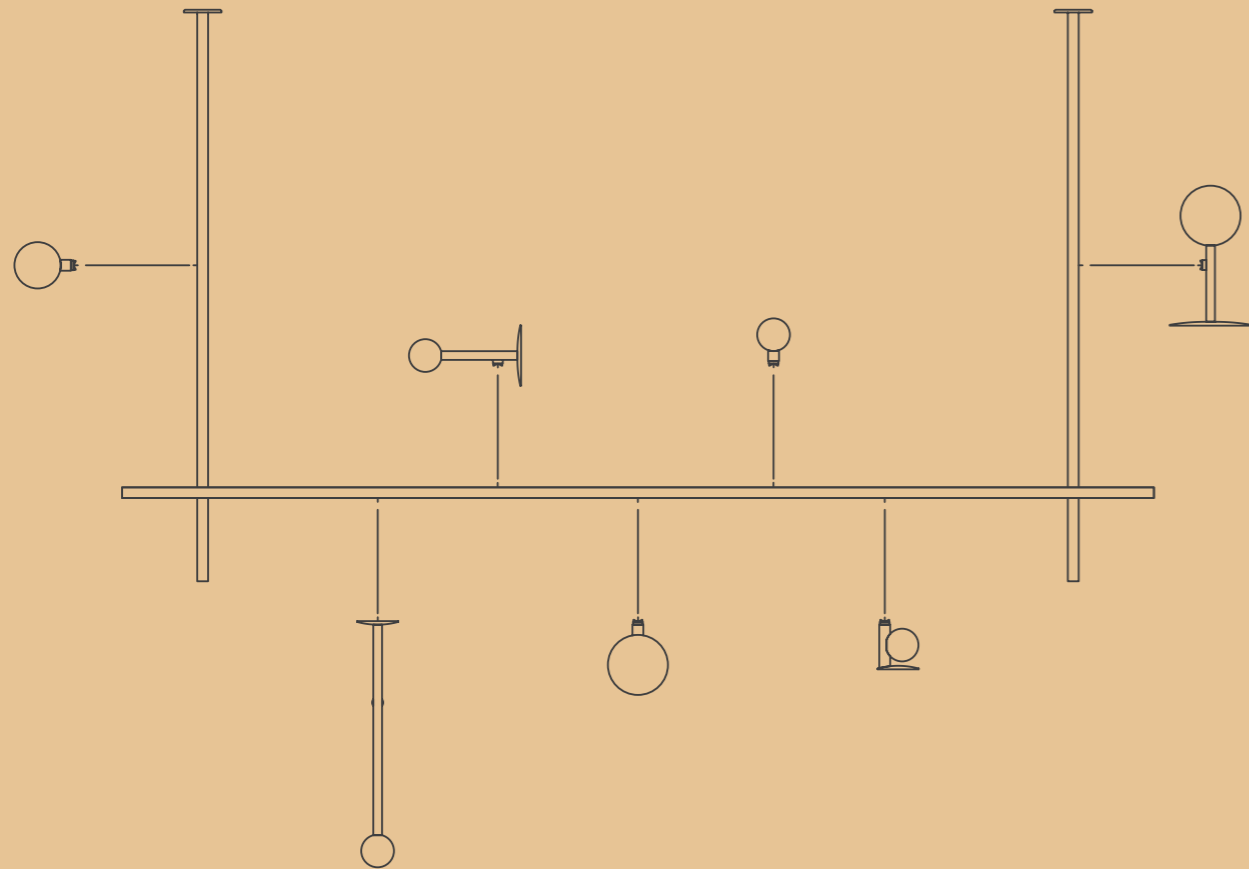

COMPOSITIONS

A

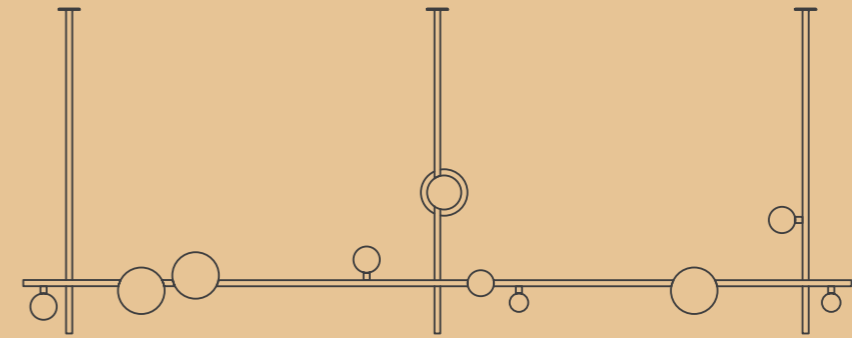

B

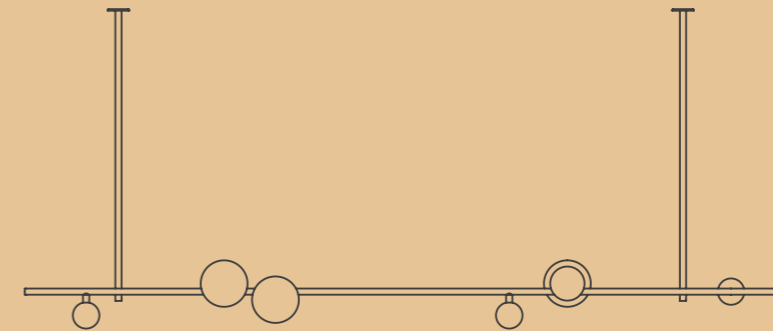

C

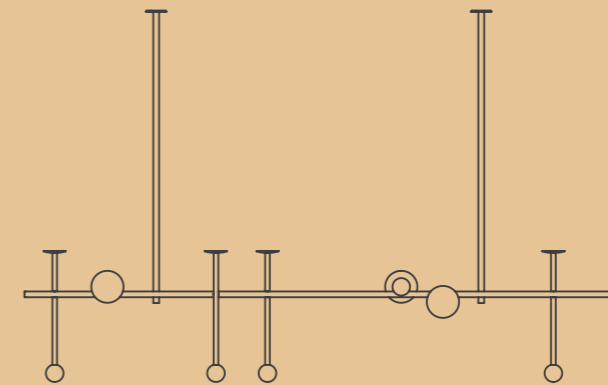

3D CHANDELIERS

CUSTOM COMPOSITIONS MAY BE CURATED
USING COMBINATION OF THE 7 VELA
LIGHTS IN ANY LOCATION

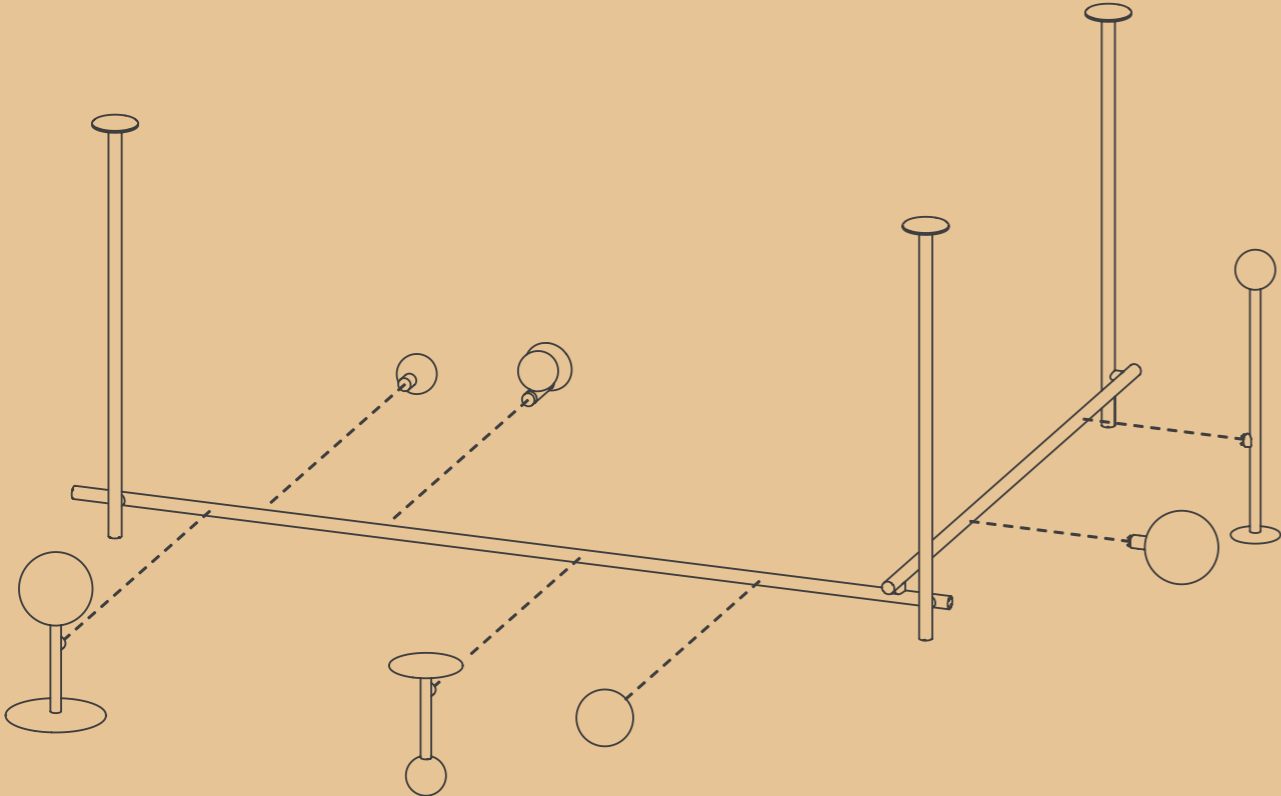

WALL RAILS

CUSTOM COMPOSITIONS MAY BE CURATED
USING COMBINATION OF THE 7 VELA
LIGHTS IN ANY LOCATION

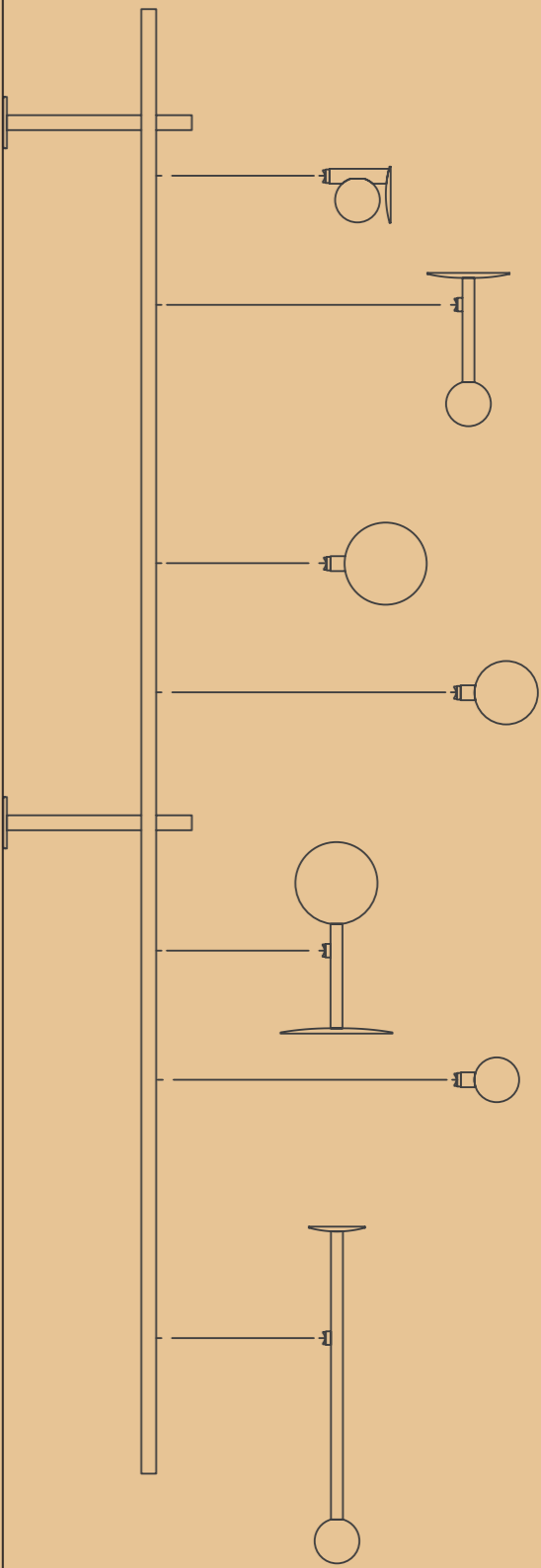

WALL SCONCE

ALL DIMENSIONS IN MILLIMETERS

GLOBE 60 SCONCE
RP-E-2106W



GLOBE 60 PLATE SCONCE
RP-E-2106WP



GLOBE 85 SCONCE
RP-E-2107W

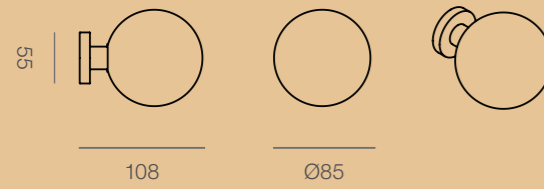

GLOBE 85 PLATE SCONCE
RP-E-2107WP

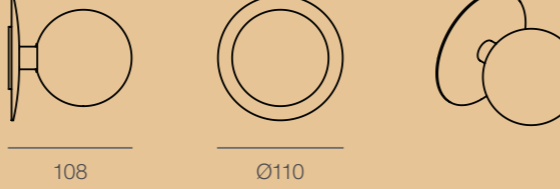

GLOBE 110 SCONCE
RP-E-2108W

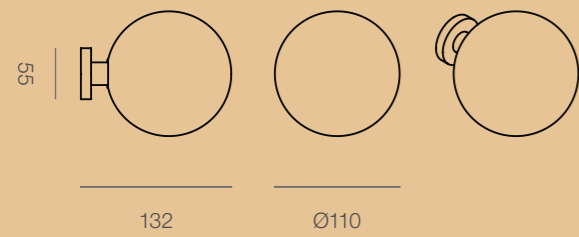

GLOBE 110 PLATE SCONCE
RP-E-2108WP

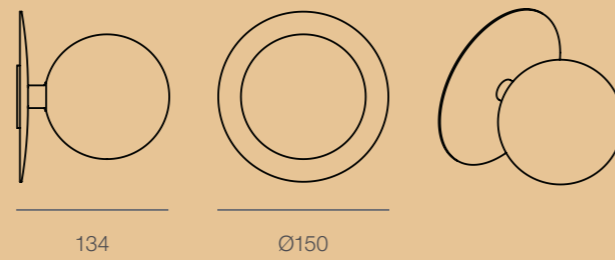

AMID SCONCE
RP-E-2109W

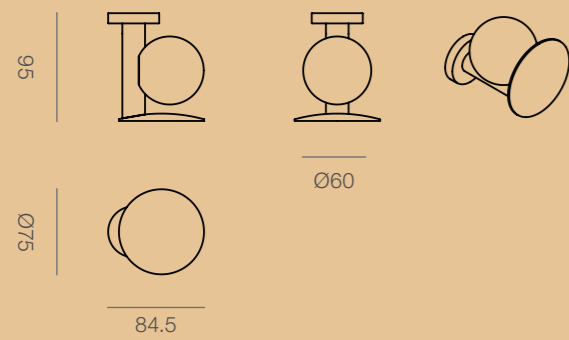

ECLIPSE 75 SCONCE
RP-E-2110W

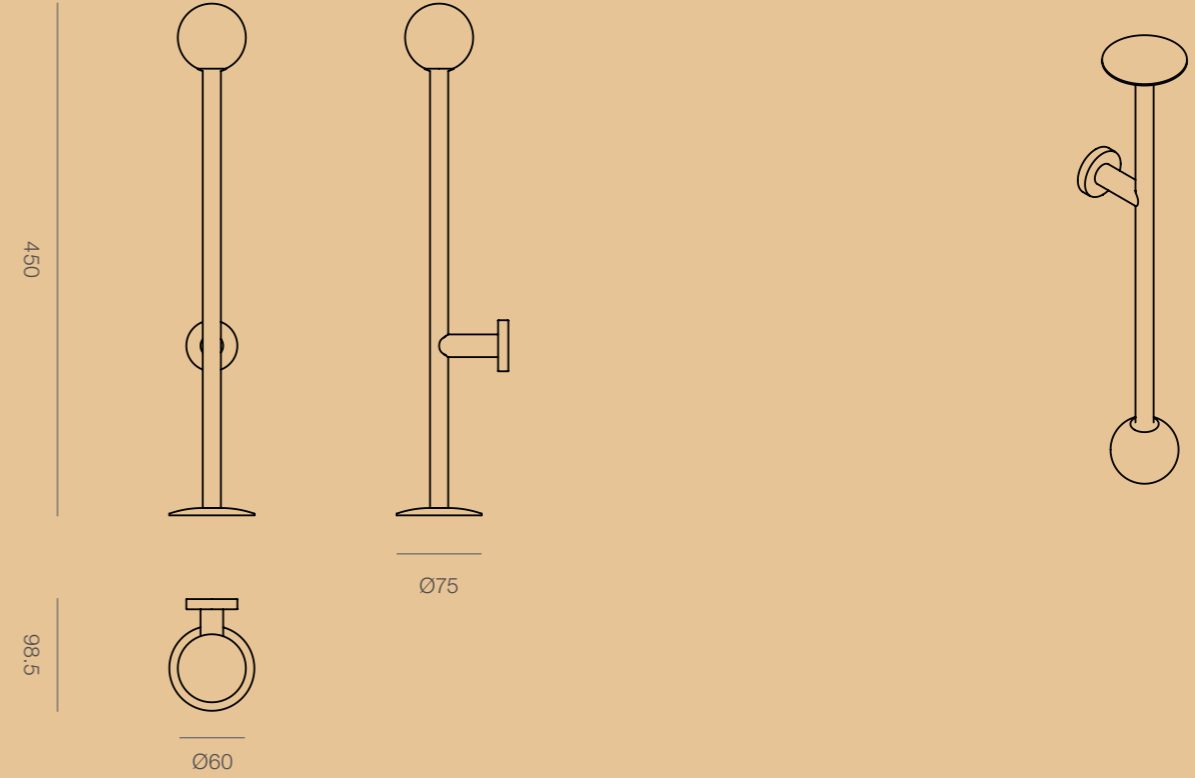

ECLIPSE 110 SCONCE
RP-E-2111W

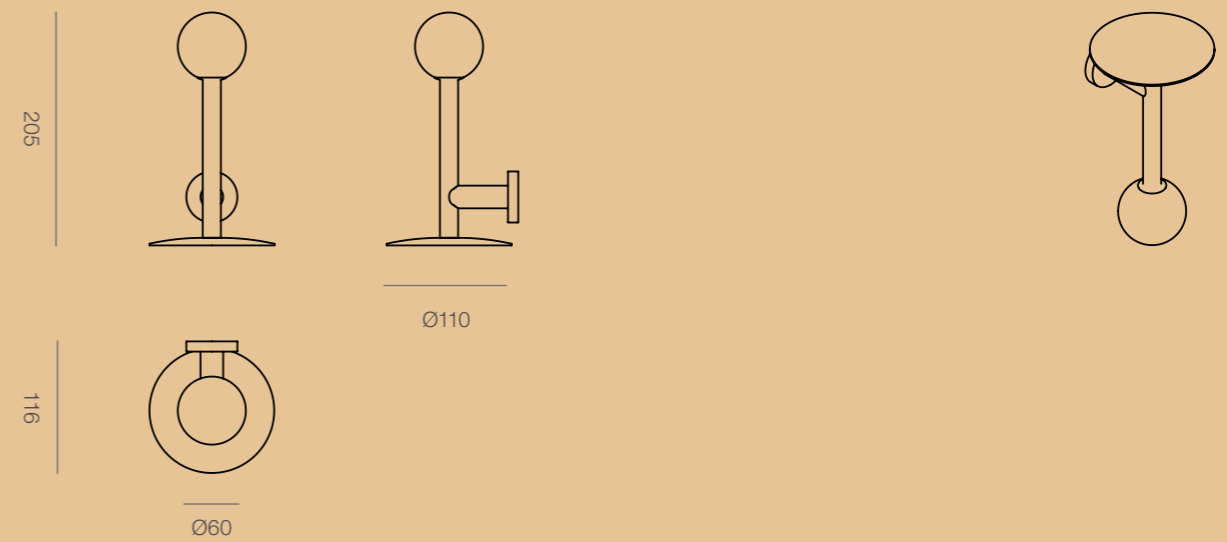

RAIL SYSTEM DETAILS

LENGTH

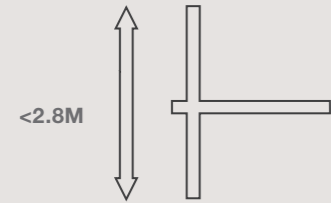

The maximum continuous length of a vertical or horizontal rail is 2.8m. Longer horizontal lengths can be created using inline joiners (see - right).

CONNECTING RAILS

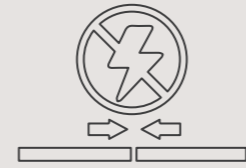

Horizontal rails may be aesthetically connected to create long spans, but power does not transfer across the joint. Each side of the joint needs to be connected to a power supply.

MOUNT - SURFACE

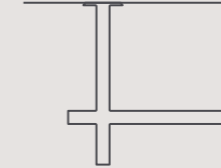

Fixed surface mount for ceiling, wall, or counter top attachment.

MOUNT - CANOPY

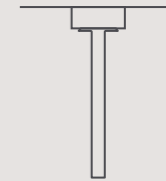

Optional canopy may be used where electrical connection outside the wall/ceiling is required.

SPAN

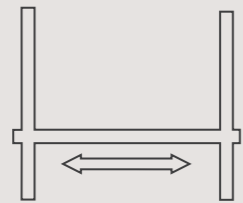

<2M

Whilst the system has no maximum horizontal length, the maximum distance between vertical supports is 2m.

CANTILEVER

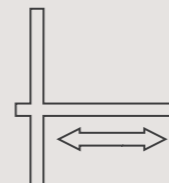

<500MM

Maximum horizontal cantilever is 0.5m and 0.5kg. Refer to product data page for luminaire weights.

MOUNT - ADJUSTABLE

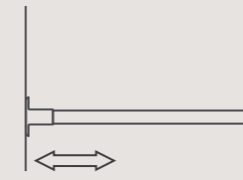

+/-20MM

Adjustable surface mount provides for up to 20mm length variation for connecting between two parallel surfaces.

DIMMING

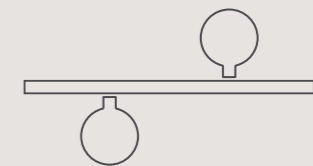

The standard driver for VELA is capable of PHASE CUT dimming - a DALI or 1-10V dimming driver can be provided on request. All VELA lights dim together.

RAIL SYSTEM DETAILS

DRIVER - REMOTE

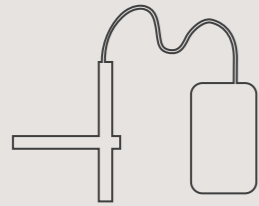

<5M

The TYPOGRAPHY driver may be located up to 5M away for the fitting to maintain correct power supply.

DRIVER - ON RAIL

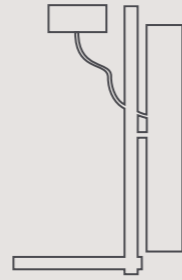

Optional on-rail driver may be used where a remote driver cannot be installed.

CASAMBI BLUETOOTH CONTROL



<10M

Optional Casambi Bluetooth control.

DIMENSIONS

RAIL CONFIGURATION

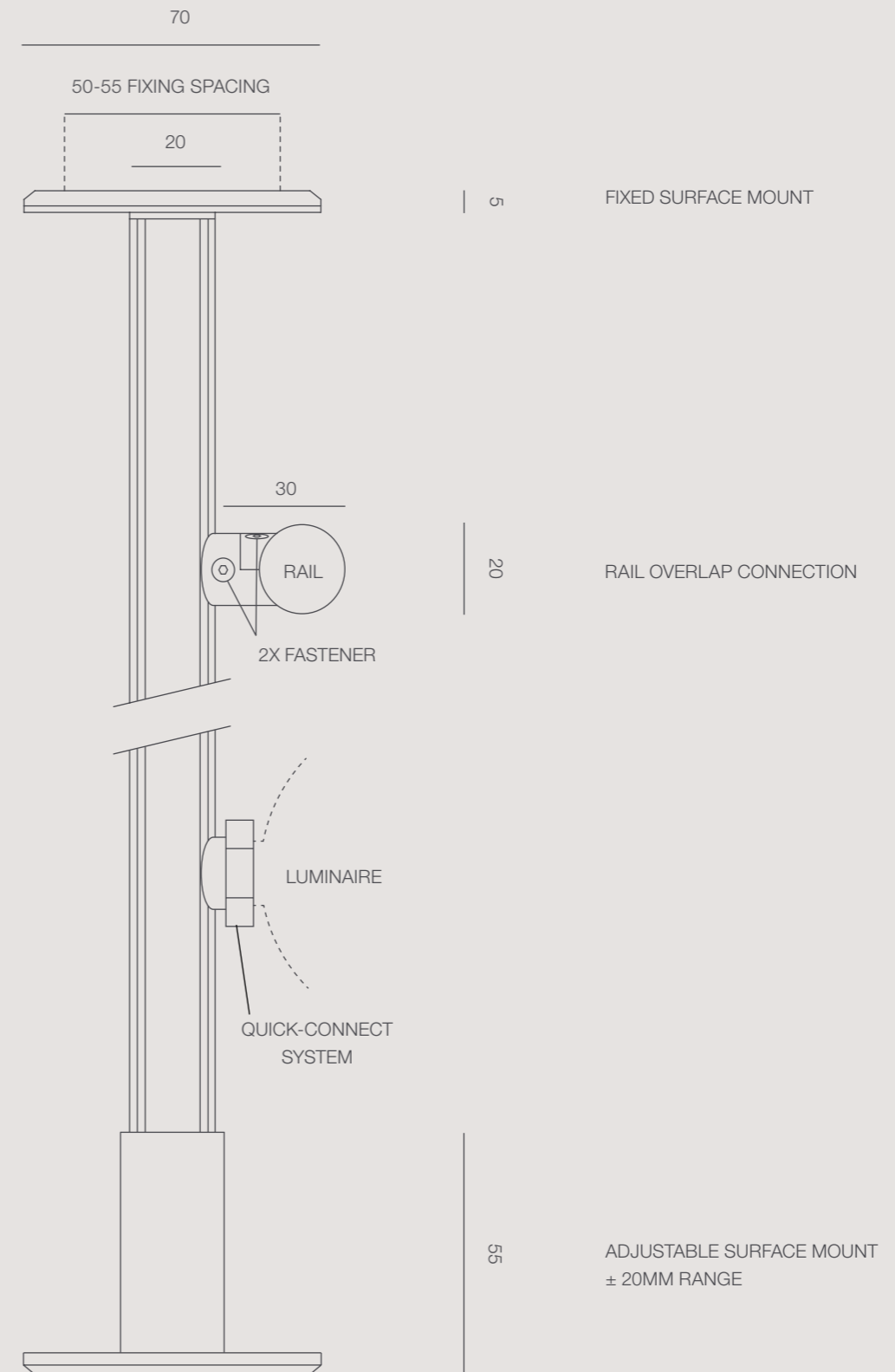

DATA

TYPOGRAPHY SYSTEM RP-E-1801	RAIL SYSTEM RP-E-1801-S1
POWER	UP TO 70W (200W AVAILABLE ON REQUEST)
PRIMARY VOLTAGE (TO DRIVER)	240VAC
SECONDARY VOLTAGE (TO FITTING)	24VDC CONSTANT VOLTAGE
PRODUCT WEIGHT	0.6KG PER 1M
PACKED WEIGHT	APPROX. 1.25KG PER 1M
PACKED DIMENSIONS	1 @ 11 X 11 X CUSTOM LENGTH CM
DRIVER LOCATION	REMOTE (ON-RAILOPTION AVAILABLE ON REQUEST)
IP RATING	IP20
APPROVALS	AUSTRALIA, NEW ZEALAND, EUROPE

* SPECIFICATIONS DEPEND ON CHOSEN LUMINAIRES, PLEASE SEE INDIVIDUAL DATA

LUMINAIRES	GLOBE 60	GLOBE 85	GLOBE 110	AMID	ECLIPSE 75	ECLIPSE 110	ECLIPSE 150
	RP-E-2106	RP-E-2107	RP-E-2108	RP-E-2109	RP-E-2110	RP-E-2111	RP-E-2112
	RP-E-2106W	RP-E-2107W	RP-E-2108W	RP-E-2109W	RP-E-2110W	RP-E-2111W	
	RP-E-2106WP	RP-E-2107WP	RP-E-2108WP				
LIGHTSOURCE	INTEGRATED LED						
POWER	3.4W	3.4W	4.1W	3.4W	3.4W	3.4W	4.1W
LUMENS (DELIVERED)	260LM	260LM	300LM	260LM	260LM	260LM	300LM
COLOUR TEMPERATURE	2700K						
CRI	CRI90						
PRODUCT WEIGHT (RAIL/SCONCE)	0.1KG	0.1KG	0.2KG	0.2KG	0.2KG	0.2KG	0.5KG
PRODUCT WEIGHT (SCONCE WITH PLATE)	0.15KG	0.2KG	0.37KG	N/A	N/A	N/A	N/A
IP RATING	IP20						
L70	70,000 HOURS						
APPROVALS	AUSTRALIA, NEW ZEALAND						



STUDIO TRULY TRULY

Truly Truly is a Rotterdam (NL) based design studio founded by Australian husband and wife design team Joel & Kate Booy. The studio operates on the interface between industry and art. Kate and Joel run a versatile practice, creating textiles, lighting, furniture and spatial installations for internationally renowned design brands.