

CILON TYPOGRAPHY

RP-E-1801



Rakumba

WWW.RAKUMBA.COM
SALES@RAKUMBA.COM

ALL RIGHTS RESERVED © RAKUMBA, 2021
PHOTOGRAPHY BY HAYDN CATTACH & PIM TOP
STYLING BY MARSHA GOLEMAC

Rakumba



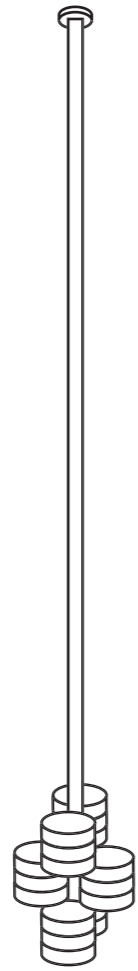

CONTENTS

INTRODUCTION	07
PENDANT	08
WALL	45
SPECIFY	54
FINISHES	54
OPTIONS	55
DIMENSIONS	56
COMPOSITIONS	58
SYSTEM DETAILS	68
DATA	74

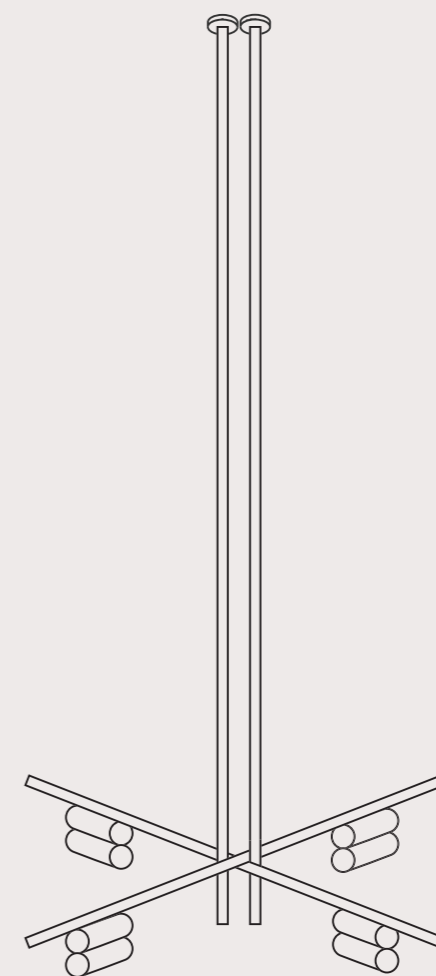

TYPOGRAPHY CILON

RP-E-1801

Studio Truly Truly and Rakumba have designed a lighting system of exceptional flexibility and purity of form.

Mix and match to create endless expressions
Rail System | 7 Luminaires
Flexibly positioned | Individually controlled
| Infinite combinations
Pendant | Chandelier | Wall

An advanced rail, almost impossibly thin, allows for the complete mobility of any light along the line. Each light can be positioned on four sides of the central axis and can be controlled independently of any other. Combining multiple rails in vertical or horizontal orientations enables TYPOGRAPHY to be formed into endless expressions; from simple pendants or wall arrangements to dramatic chandeliers - almost limitless design solutions.



“The system is inspired by the way letters form words, and how these can be arranged in relationships to form a language of expression.”

————— Studio Truly Truly



















Typography's first collection, CILON, consists of seven different lighting fixtures, or characters. Each light can be positioned on four sides of the central axis and can be controlled independently of any other.





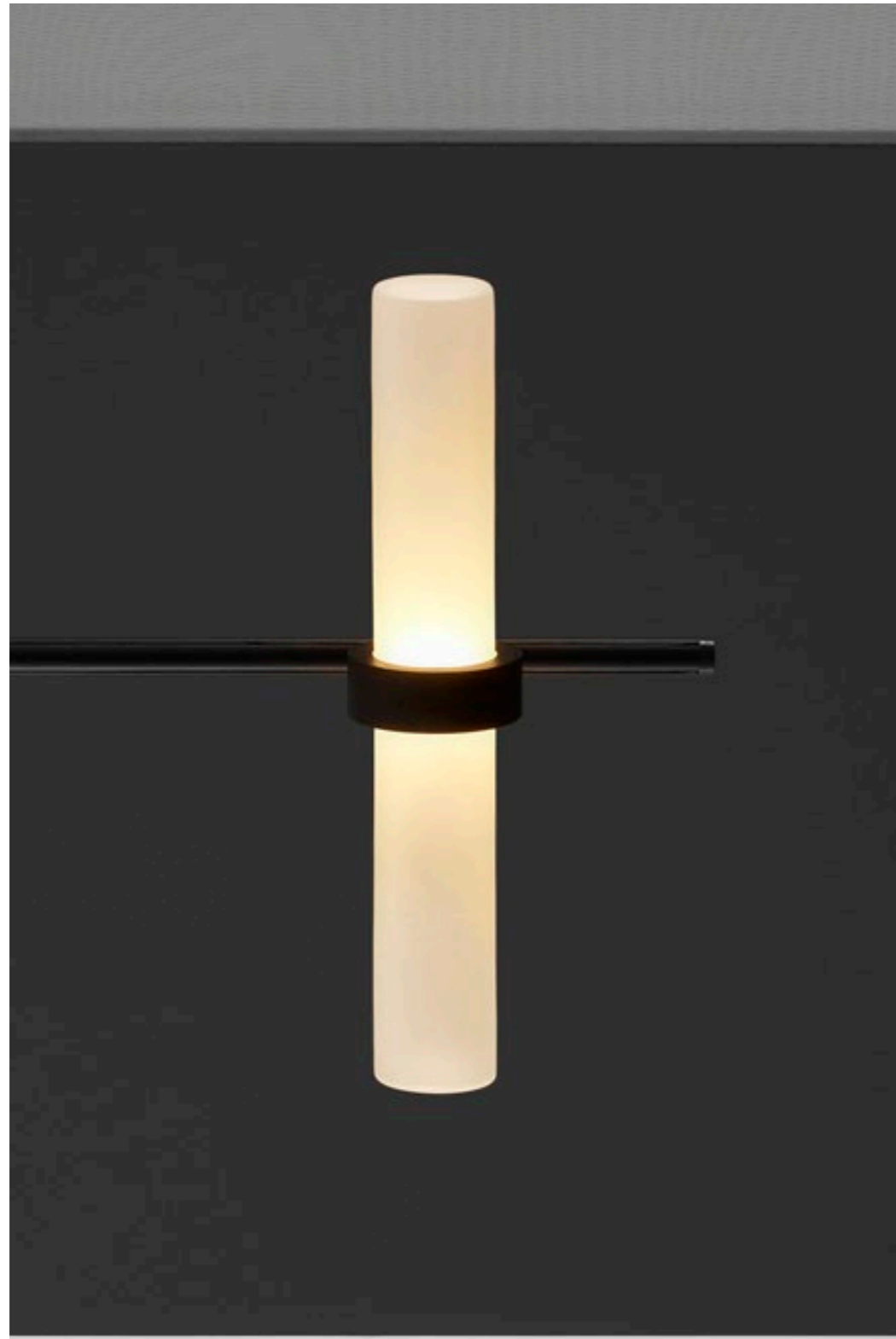





"We are constantly trying to appeal to our own desire to be surprised, captivated or moved. Our work is often sculptural or poetic, with tactility, sensuality and functionality playing an important role."

_____ Studio Truly Truly





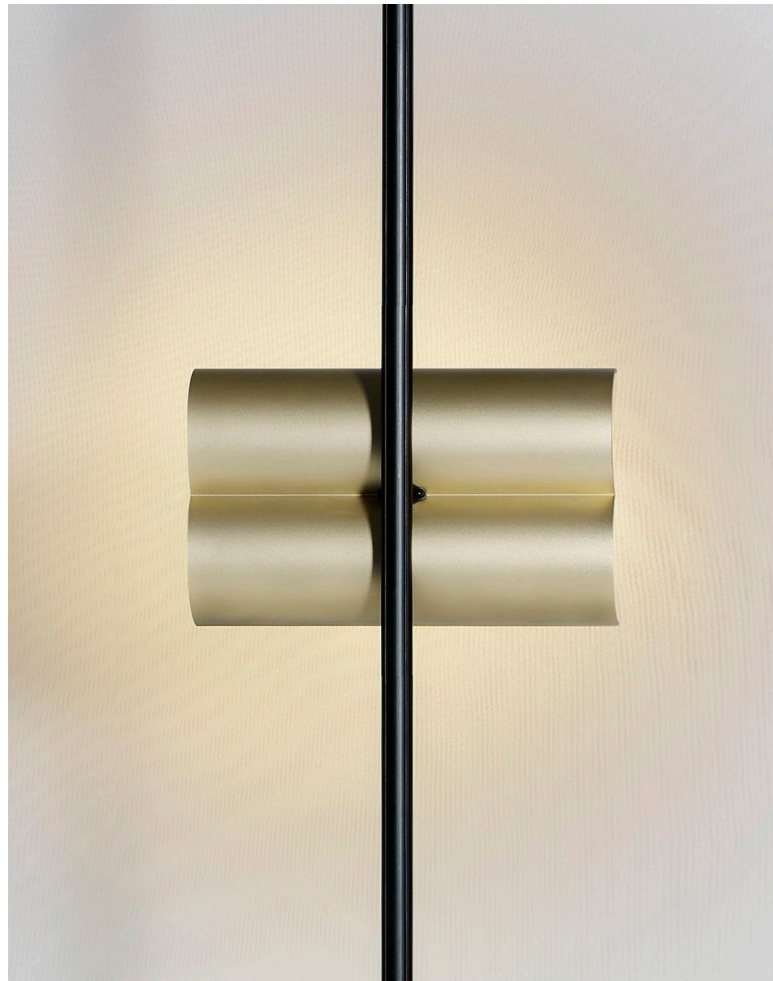







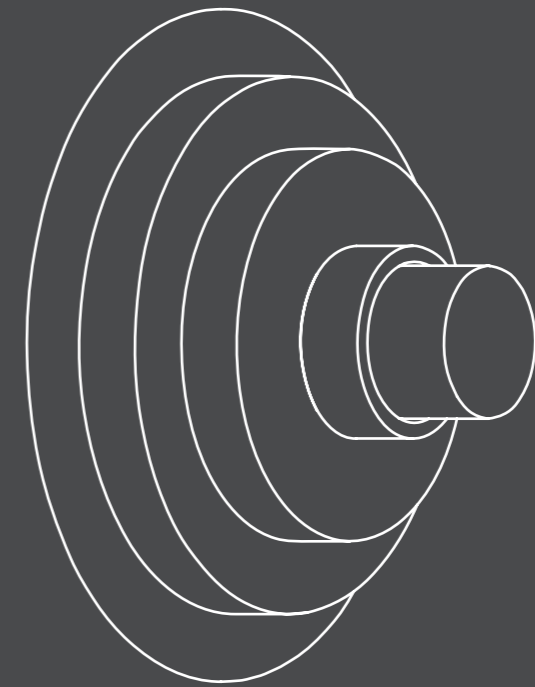

WALL

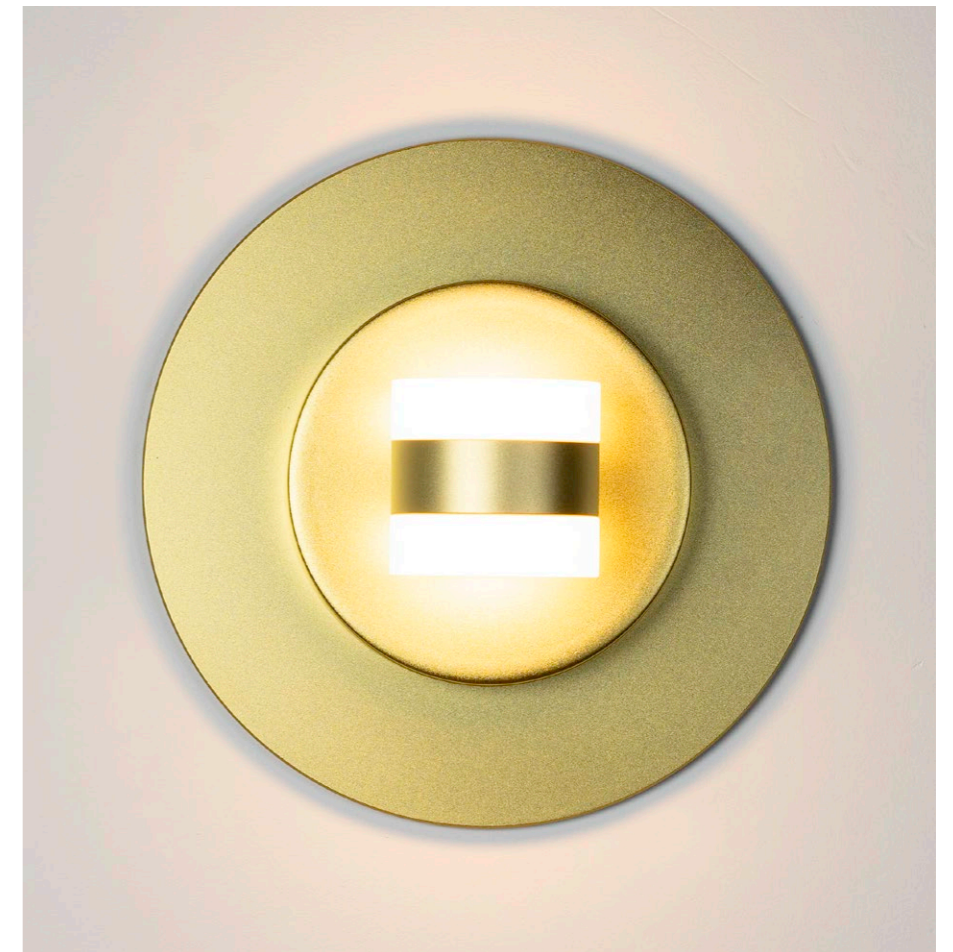



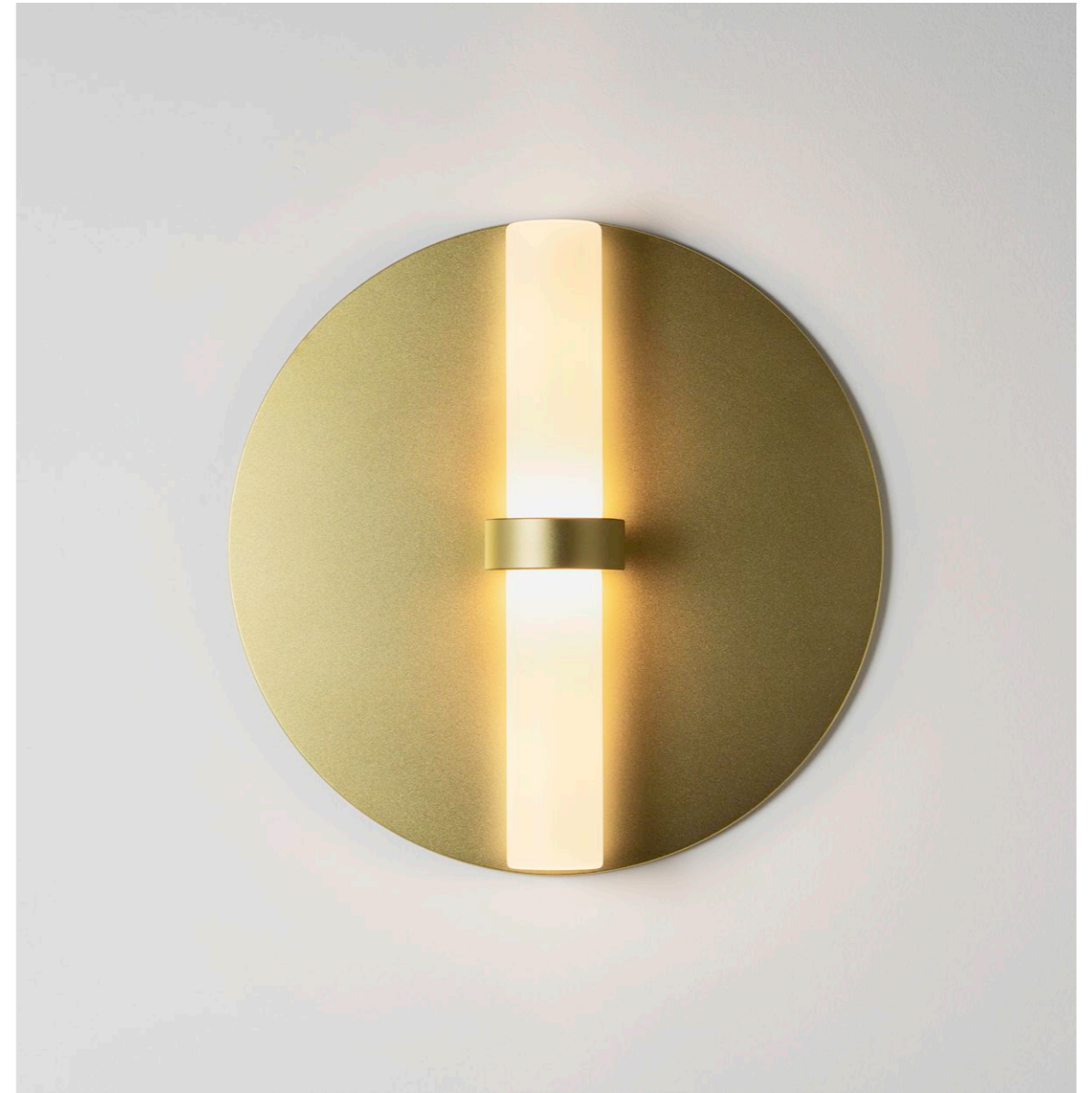

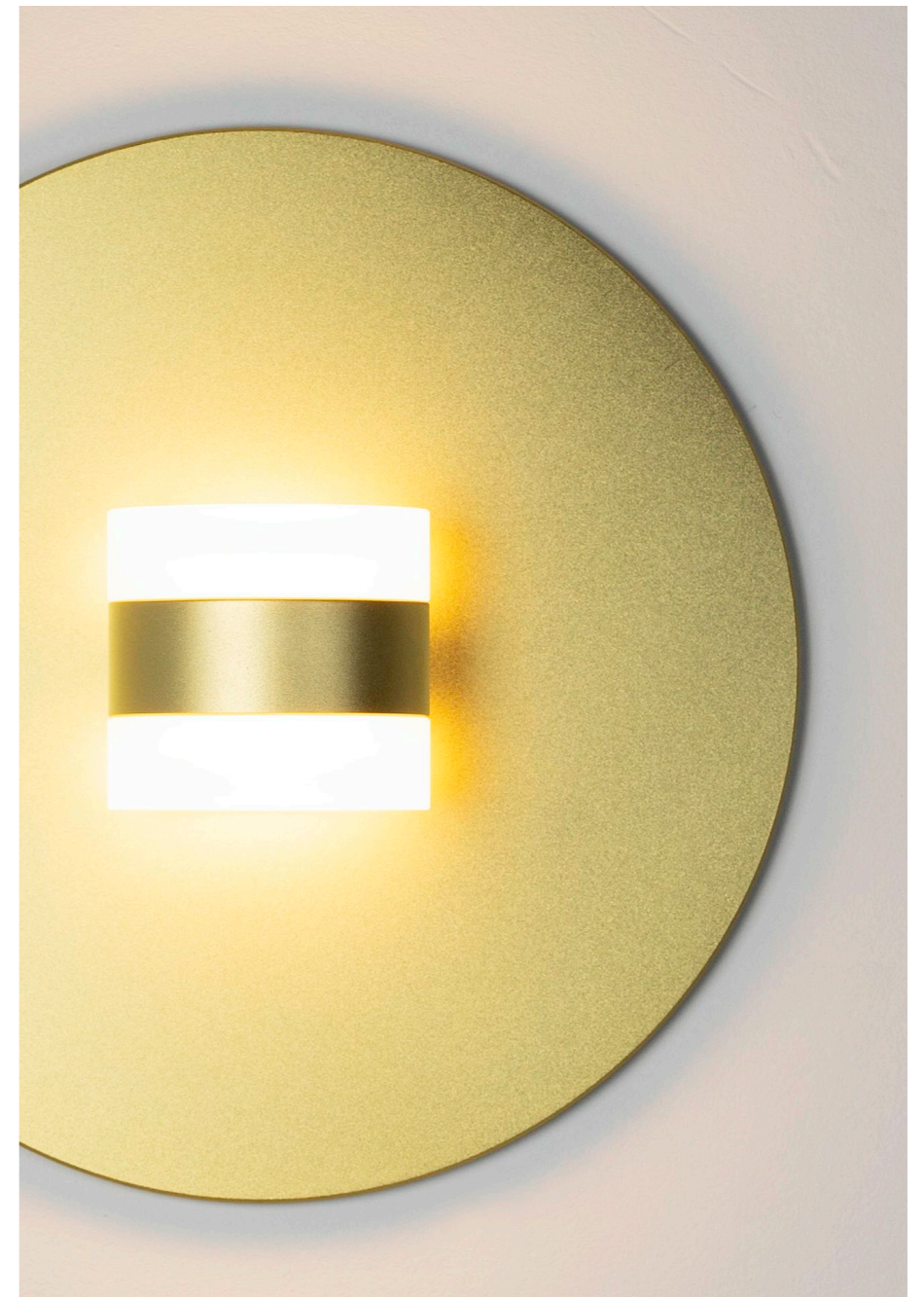

MATERIALS & FINISHES

ANODISED ALUMINIUM // STAINLESS STEEL //
PMMA OR FROSTED GLASS

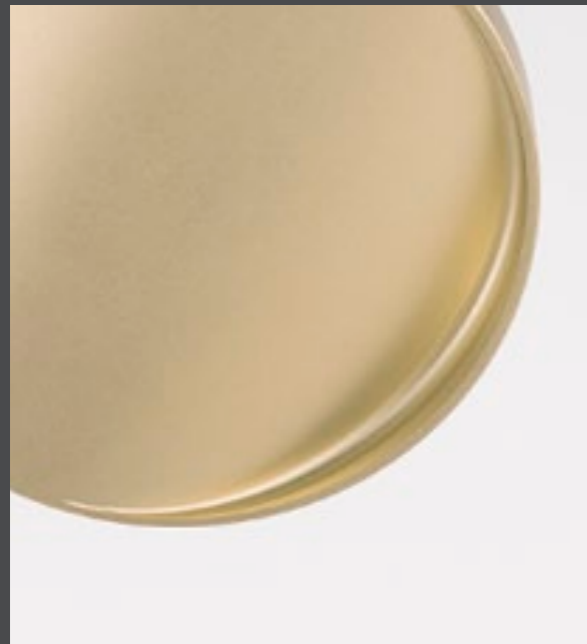

GOLDEN ANODISED

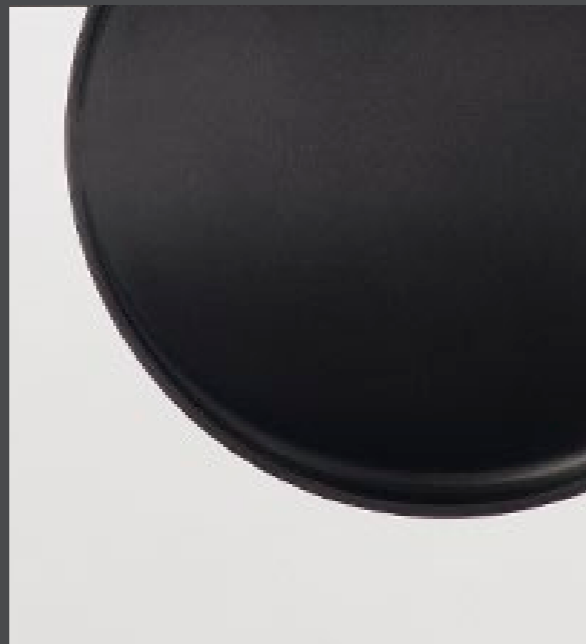

BLACK ANODISED



RED
PMS 195 C



BLUE
PMS 7545 C



GREEN
PMS 5635 C

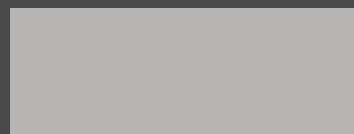

GREY
PMS 420 U

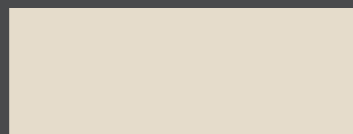

BEIGE
PMS 482C

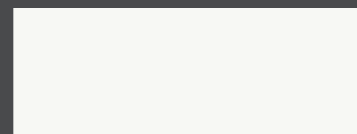

SATIN WHITE
PMS 11-0601 TCX

OPTIONS

RAIL CONFIGURATION

- | | | | | |
|--------------|-----------------------|---------------------|-----------------------|--------|
| RAIL LENGTH: | <input type="radio"/> | 150MM | <input type="radio"/> | 500MM |
| | <input type="radio"/> | 750MM | <input type="radio"/> | 1000MM |
| | <input type="radio"/> | 1200MM | <input type="radio"/> | 1500MM |
| | <input type="radio"/> | 1800MM | <input type="radio"/> | 2000MM |
| | <input type="radio"/> | 2500MM | <input type="radio"/> | 2800MM |
| | <input type="radio"/> | CUSTOM (MAX 2800MM) | | |

- | | | |
|---------|-----------------------|-----------------|
| FINISH: | <input type="radio"/> | BLACK ANODISED |
| | <input type="radio"/> | GOLDEN ANODISED |

- | | | | | |
|---------|-----------------------|--------------------|-----------------------|---------------|
| MOUNTS: | <input type="radio"/> | CEILING MOUNT | <input type="radio"/> | CANOPY |
| | <input type="radio"/> | WALL MOUNT | <input type="radio"/> | (FOR CONCRETE |
| | <input type="radio"/> | COUNTER TO CEILING | <input type="radio"/> | SUBSTRATE) |
| | <input type="radio"/> | WALL TO WALL | | |

- | | | | | |
|-------------|-----------------------|-------|-----------------------|------|
| LUMINAIRES: | <input type="radio"/> | SPOT | <input type="radio"/> | MINI |
| | <input type="radio"/> | ROLL | <input type="radio"/> | RIB |
| | <input type="radio"/> | STAFF | <input type="radio"/> | DISC |
| | <input type="radio"/> | LAYER | | |

RAIL LUMINAIRES AVAILABLE IN ANODISED FINISHES

WALL

- | | | | | |
|---------|-----------------------|-----------------|-----------------------|-------------|
| FINISH: | <input type="radio"/> | BLACK ANODISED | <input type="radio"/> | GREEN |
| | <input type="radio"/> | GOLDEN ANODISED | <input type="radio"/> | BEIGE |
| | <input type="radio"/> | RED | <input type="radio"/> | GREY |
| | <input type="radio"/> | BLUE | <input type="radio"/> | SATIN WHITE |

- | | | | | |
|---------|-----------------------|----------------------|-----------------------|-------------------------------|
| MODELS: | <input type="radio"/> | STAFF SCONCE | <input type="radio"/> | LAYER WALL MEDIUM STACK |
| | <input type="radio"/> | STAFF WALL XXL | <input type="radio"/> | MINI SCONCE |
| | <input type="radio"/> | STAFF WALL XXL STACK | <input type="radio"/> | MINI WALL MEDIUM |
| | <input type="radio"/> | LAYER SCONCE | <input type="radio"/> | MINI WALL MEDIUM DOUBLE STACK |
| | <input type="radio"/> | LAYER WALL MEDIUM | <input type="radio"/> | RIB SCONCE |

- | | | |
|----------|-----------------------|-----------------|
| DIMMING: | <input type="radio"/> | NONE |
| | <input type="radio"/> | PHASE-CUT |
| | <input type="radio"/> | DALI/SWITCH DIM |

DIMENSIONS

ALL DIMENSIONS IN MILLIMETERS

LUMINAIRES

CILON SPOT
RP-E-1802

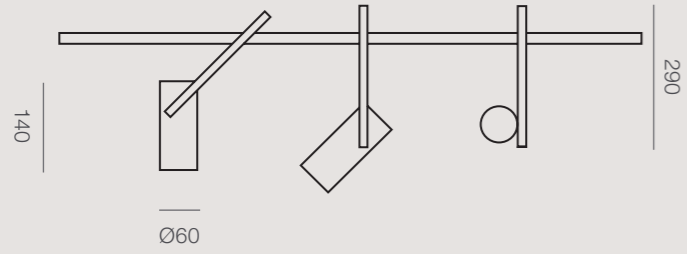

CILON ROLL
RP-E-1803

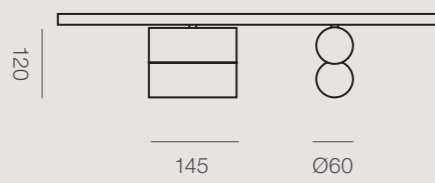

CILON STAFF
RP-E-1804

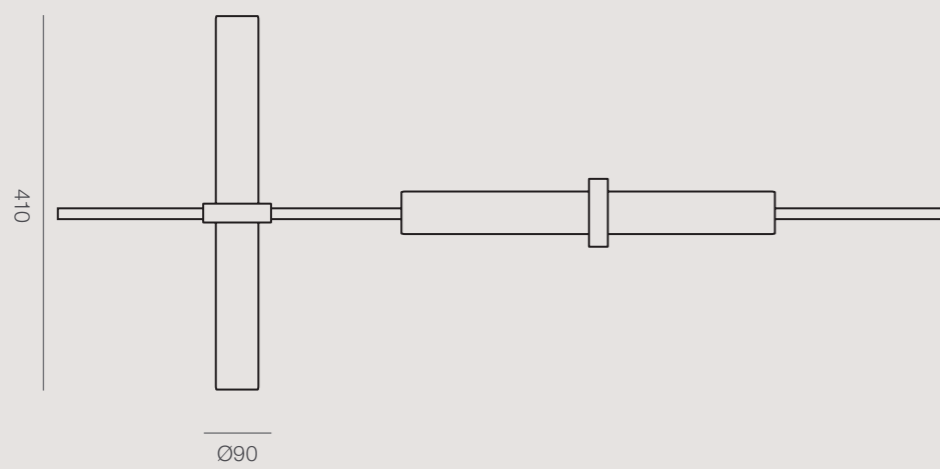

CILON LAYER
RP-E-1805

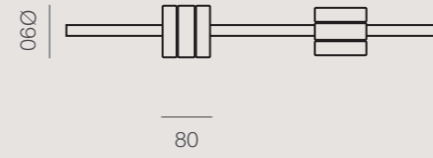

CILON MINI
RP-E-1806

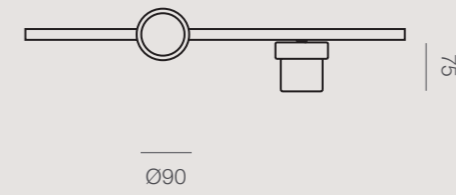

CILON RIB
RP-E-1807

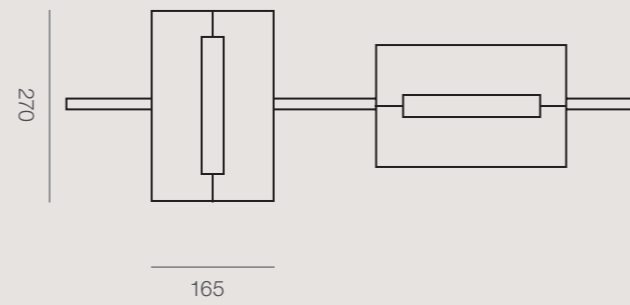

CILON DISC
RP-E-1808

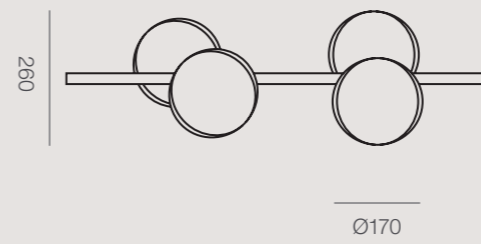

PENDANTS

CUSTOM COMPOSITIONS MAY BE CURATED
USING COMBINATION OF THE 7 CILON
LIGHTS IN ANY LOCATION

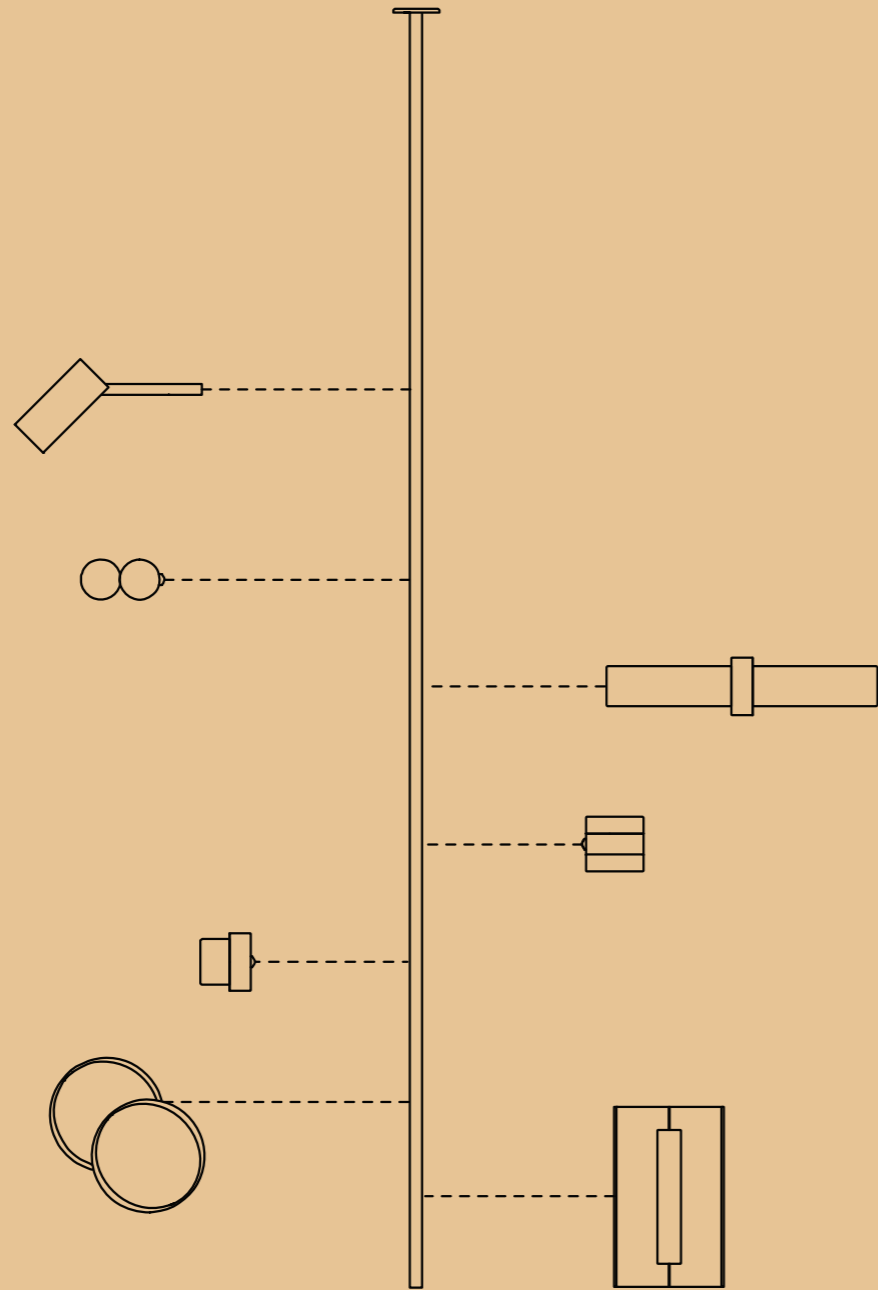

COMPOSITIONS

A

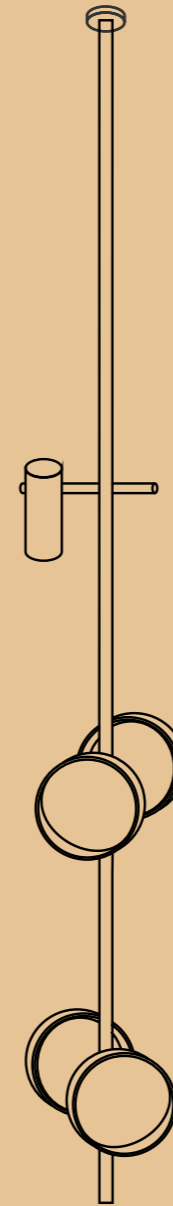

B



C



GANTRY

CUSTOM COMPOSITIONS MAY BE CURATED
USING COMBINATION OF THE 7 CILON
LIGHTS IN ANY LOCATION

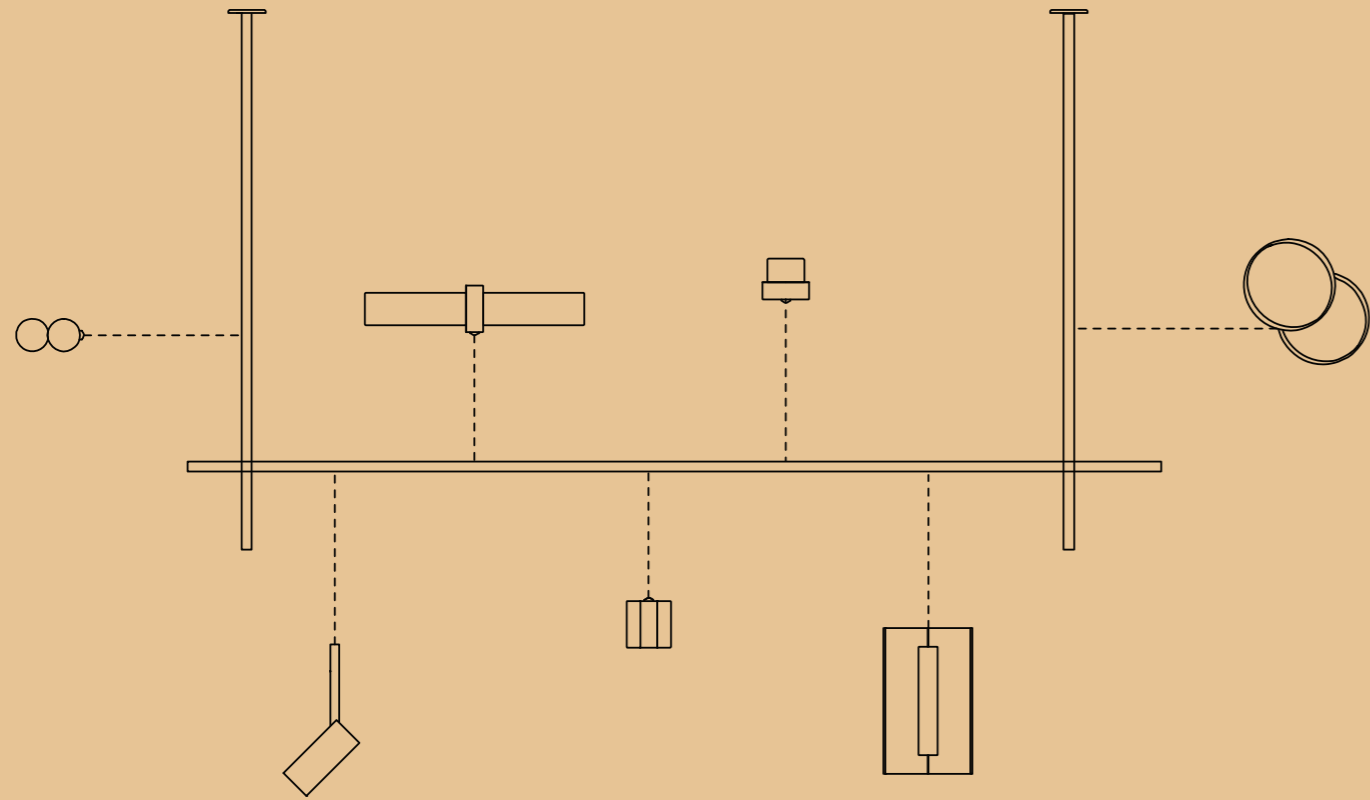

COMPOSITIONS

A

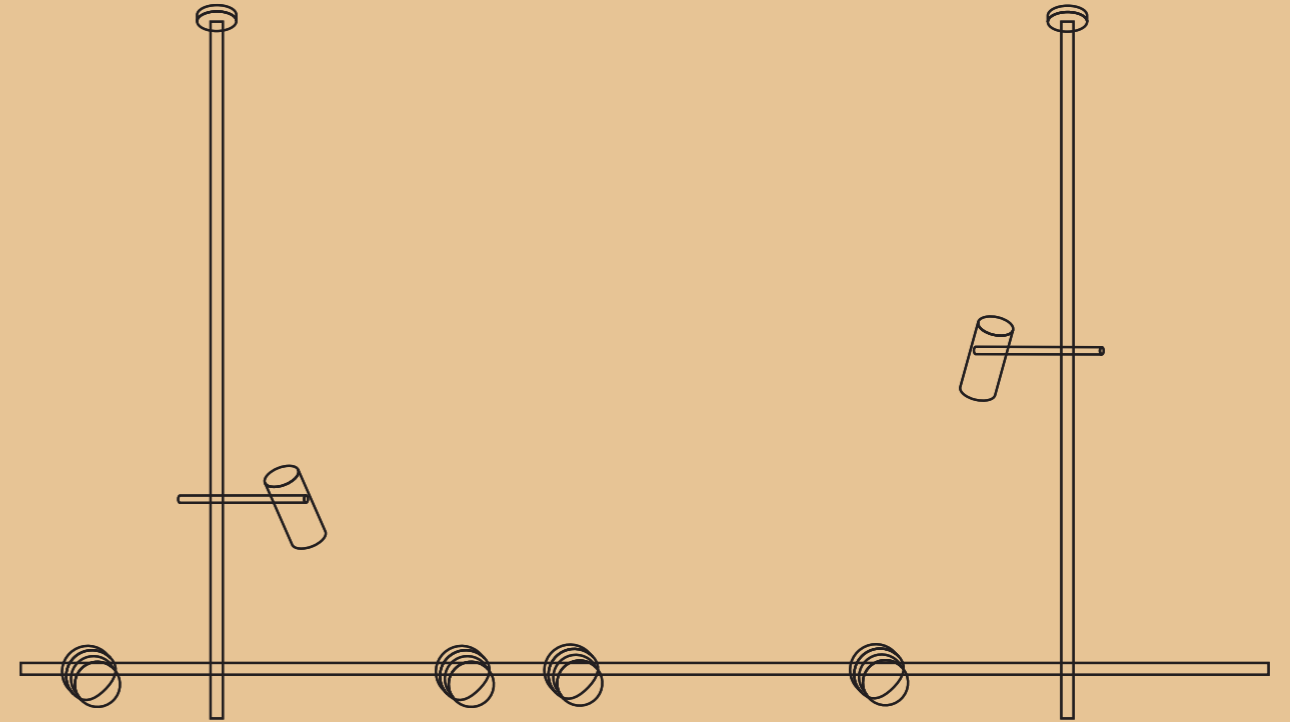

B

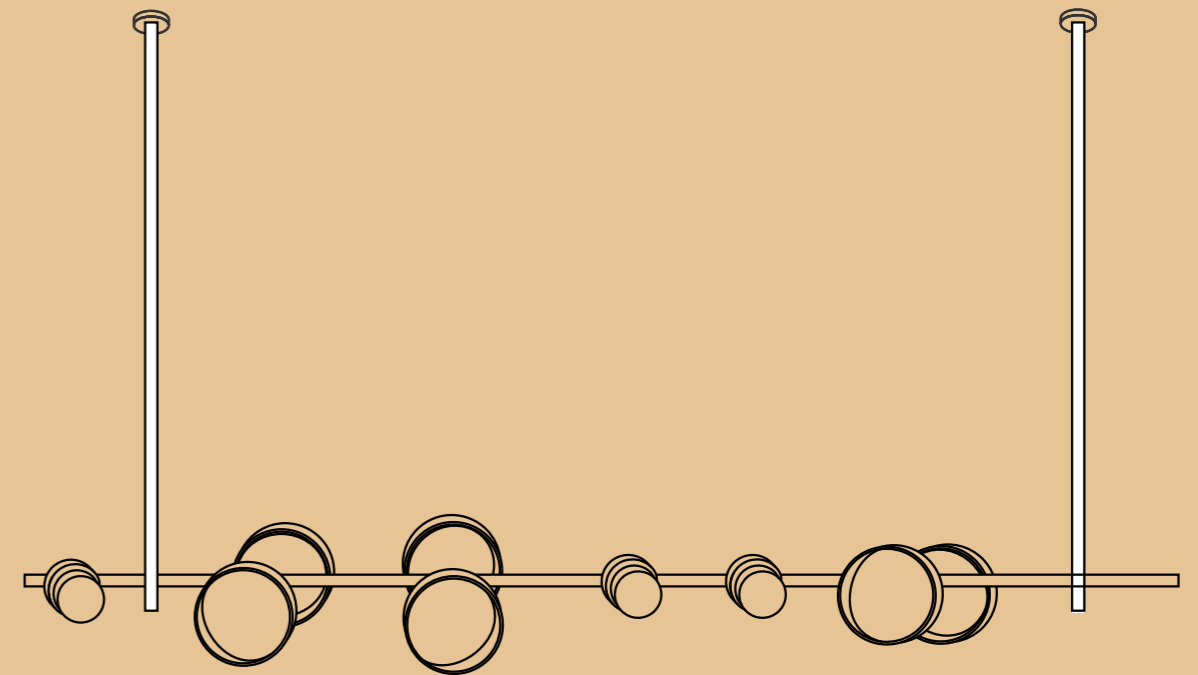

3D CHANDELIERS

CUSTOM COMPOSITIONS MAY BE CURATED
USING COMBINATION OF THE 7 CILON
LIGHTS IN ANY LOCATION

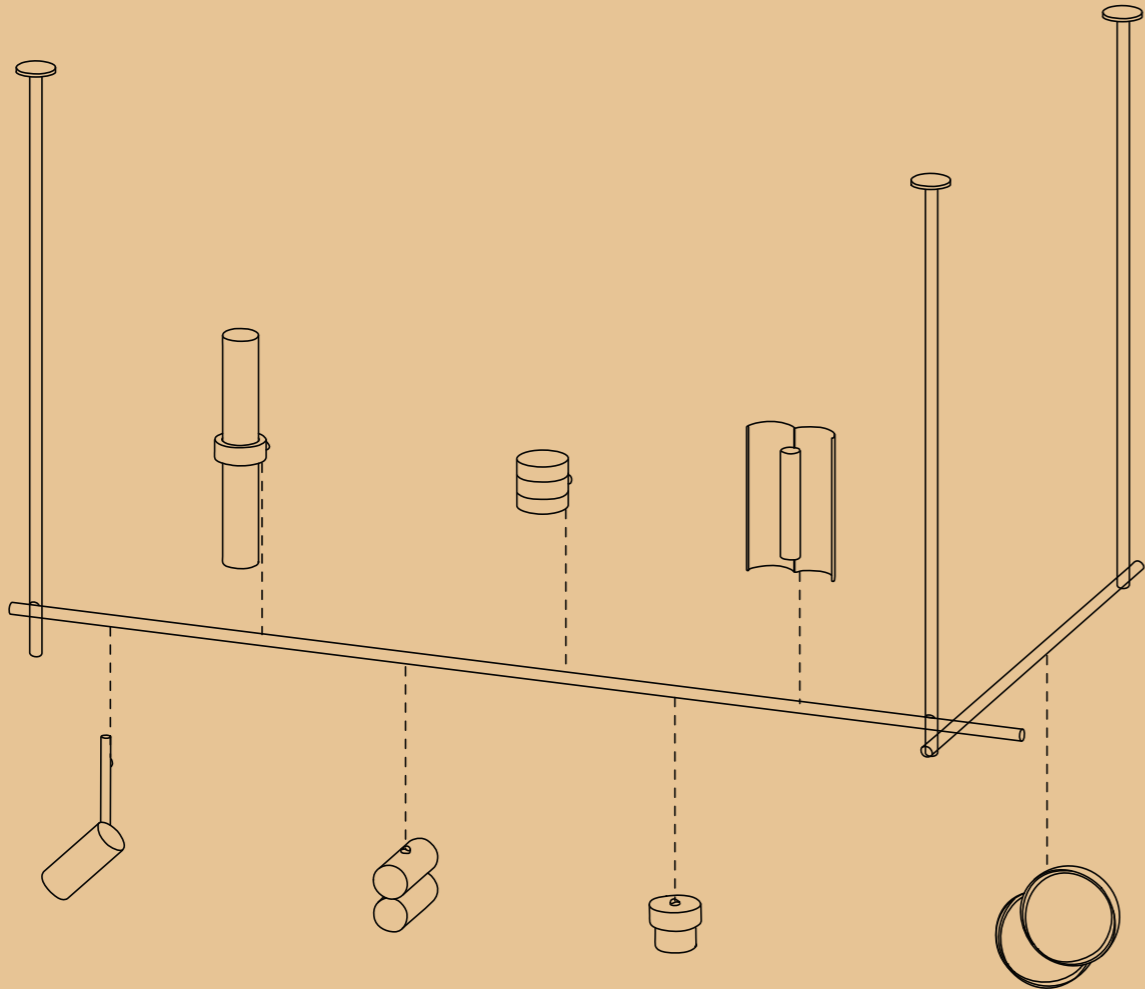

COMPOSITIONS

A

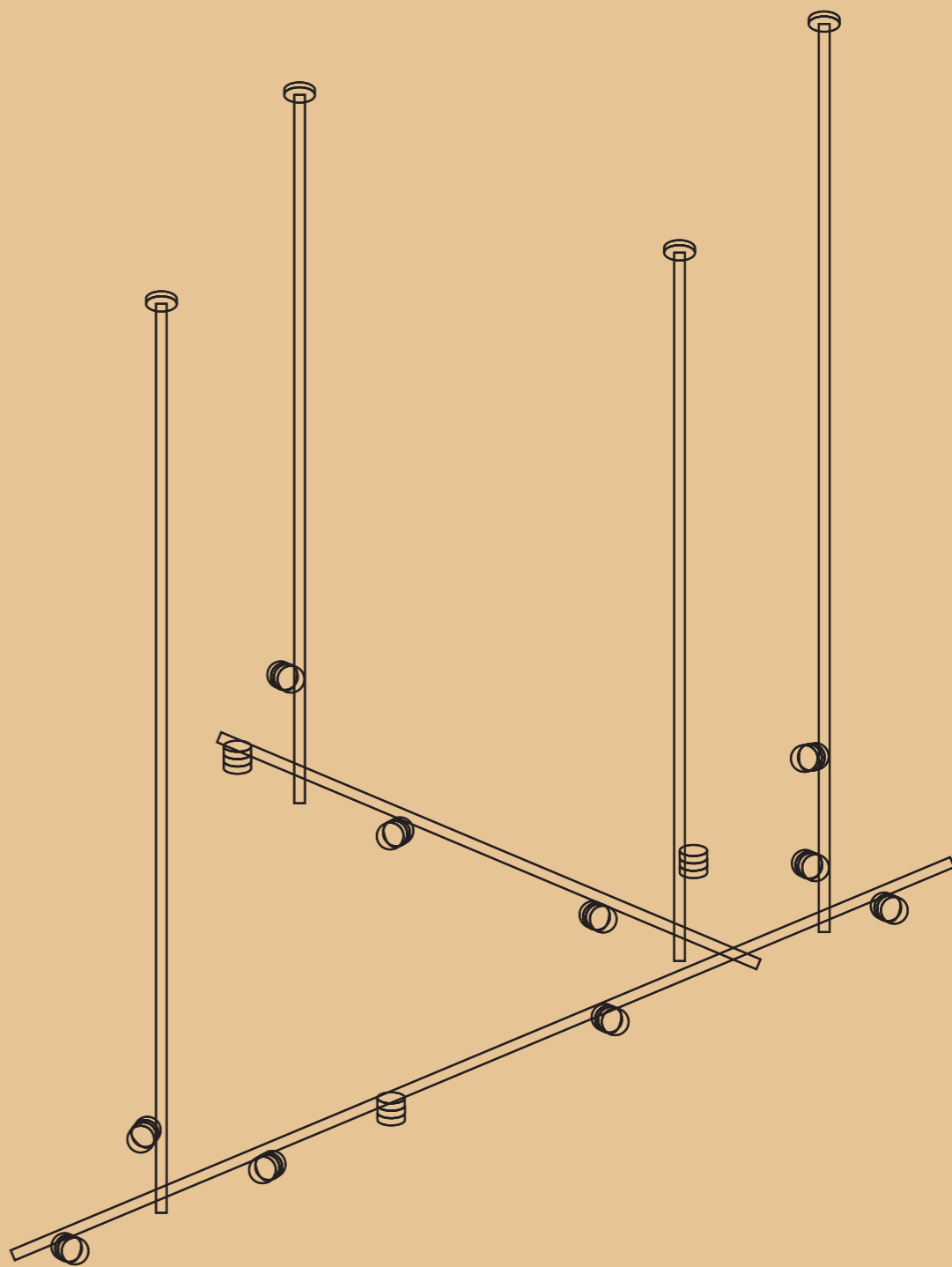

WALL RAILS

CUSTOM COMPOSITIONS MAY BE CURATED
USING COMBINATION OF THE 7 CILON
LIGHTS IN ANY LOCATION

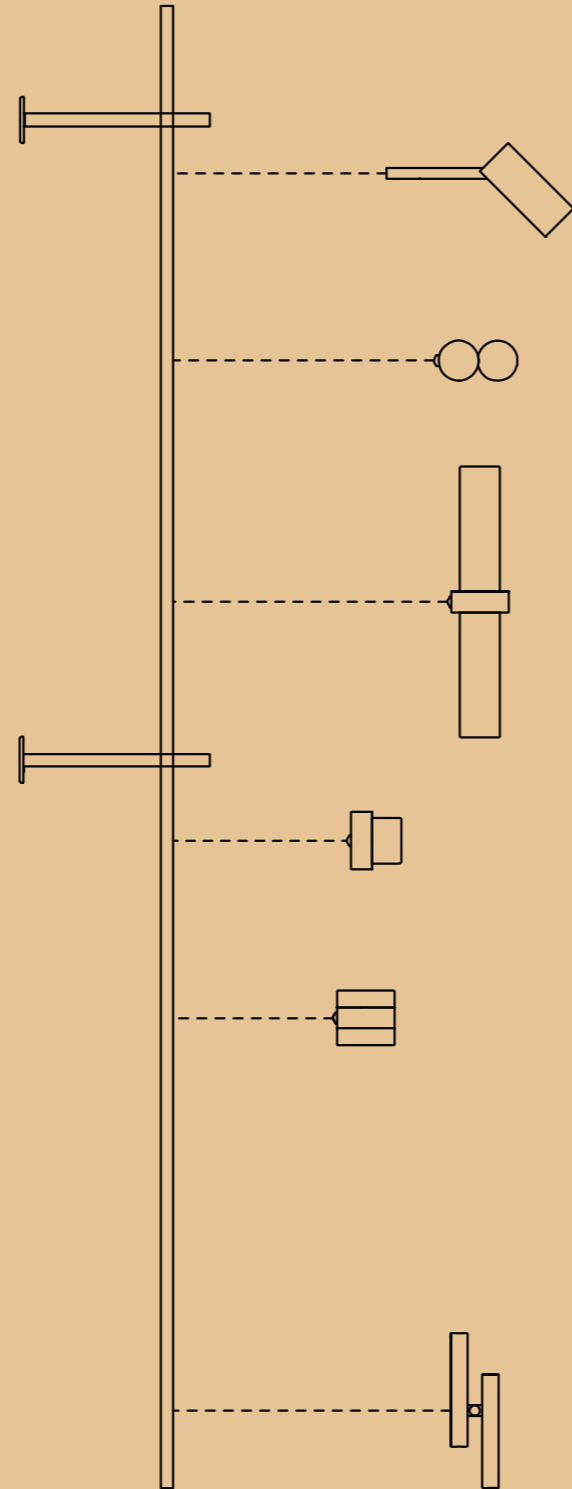

COMPOSITIONS

A

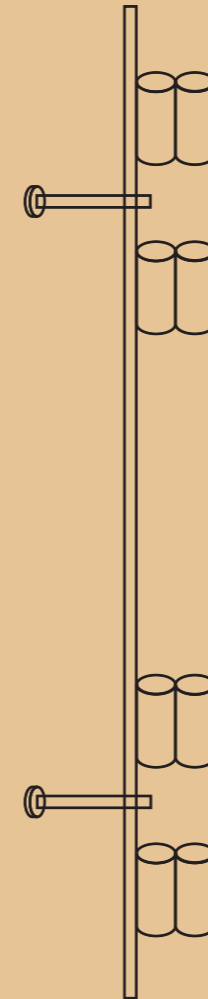

B

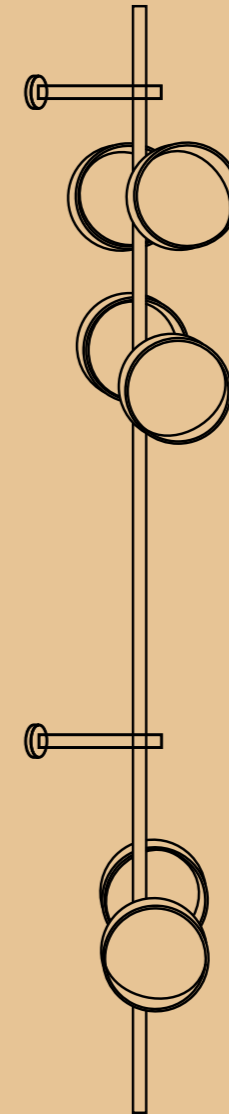

WALL

CILON STAFF
RP-E-1804W

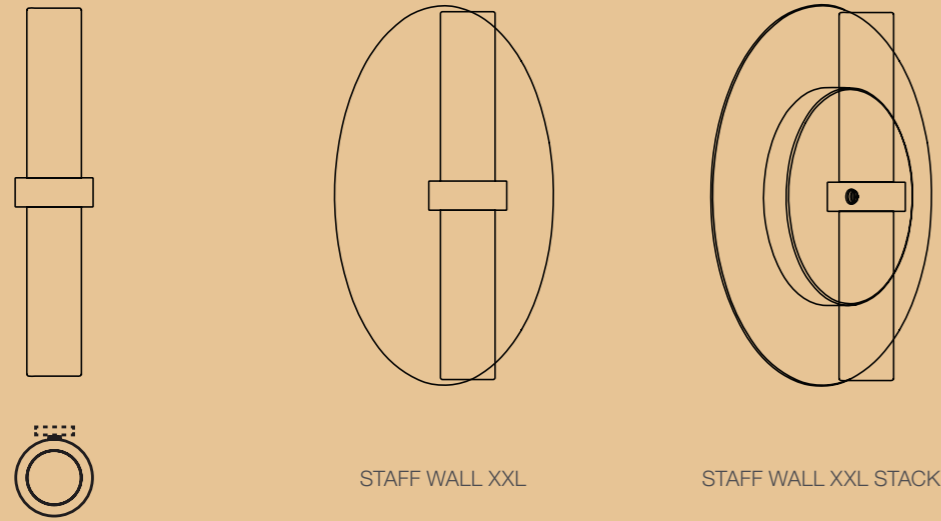

STAFF SCONCE

CILON LAYER
RP-E-1805W

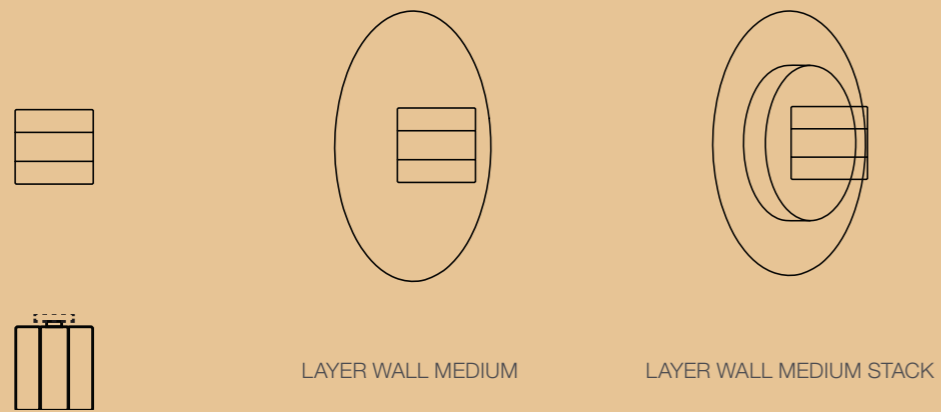

LAYER SCONCE

COMPOSITIONS

CILON MINI
RP-E-1806W

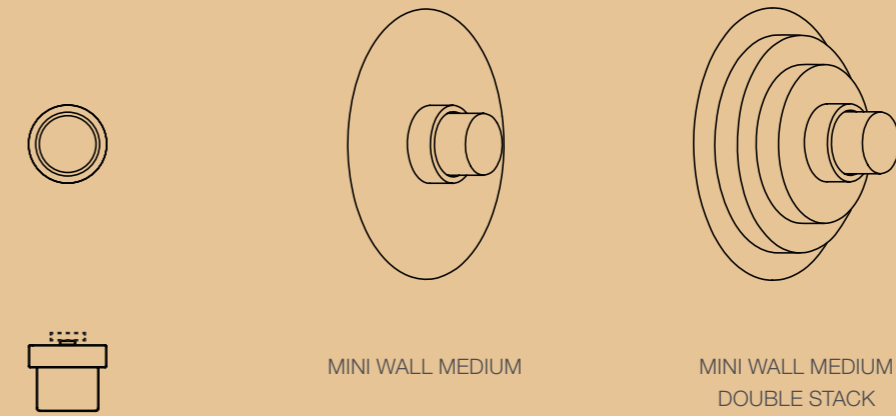

MINI SCONCE

CILON RIB
RP-E-1807W

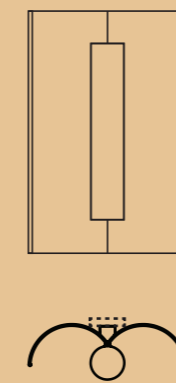

RIB SCONCE

RAIL SYSTEM DETAILS

LENGTH

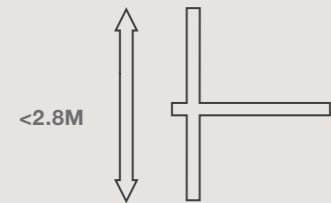

The maximum continuous length of a vertical or horizontal rail is 2.8m. Longer horizontal lengths can be created using inline joiners (see below).

CONNECTING RAILS

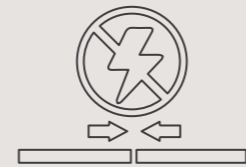

Horizontal rails may be aesthetically connected to create long spans, but power does not transfer across the joint. Each side of the joint needs to be connected to a power supply.

MOUNT - SURFACE

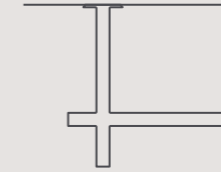

Fixed surface mount for ceiling, floor, or wall attachment.

MOUNT - CANOPY

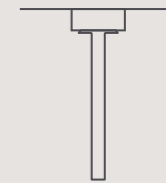

Optional canopy may be used where electrical connection outside the wall/ceiling is required.

SPAN

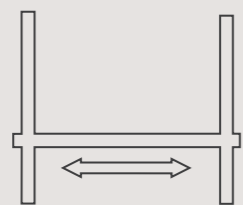

<2M

Whilst the system has no maximum horizontal length, the maximum distance between vertical drops is 2m.

CANTILEVER

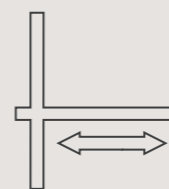

<500MM

Maximum horizontal cantilever is 0.5m and 0.5kg. Refer to product data page for luminaire weights.

MOUNT - ADJUSTABLE

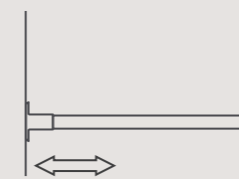

+/-40MM

Adjustable surface mount provides for up to 40mm length variation.

DIMMING

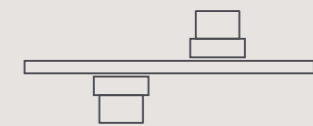

The standard driver is capable of DALI/switch-dim dimming - a 1-10V converter can be provided on request.

RAIL SYSTEM DETAILS

DRIVER - REMOTE

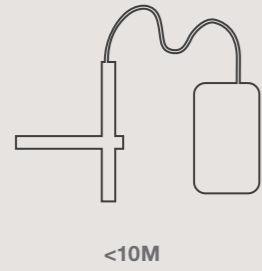

The TYPOGRAPHY driver may be located up to 10M away for the fitting to maintain correct power supply.

DRIVER - ON RAIL

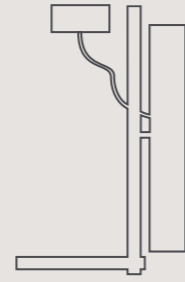

Optional on-rail driver may be used where a remote driver cannot be installed.

CASAMBI BLUETOOTH CONTROL



Optional Casambi Bluetooth control.

WALL SYSTEM DETAILS

REMOTE DRIVER

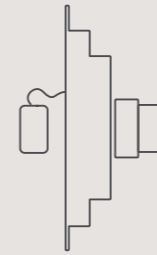

Driver is remotely located.

INTEGRATED DRIVER

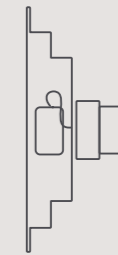

Driver may be integrated for Wall Stack configurations.

DIMMING

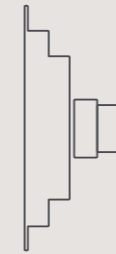

Phase Cut/TRIAC/1-10V - Remote or Integrated
DALI/Switch - Remote only

DIMENSIONS

ALL DIMENSIONS IN MILLIMETERS

RAIL CONFIGURATION

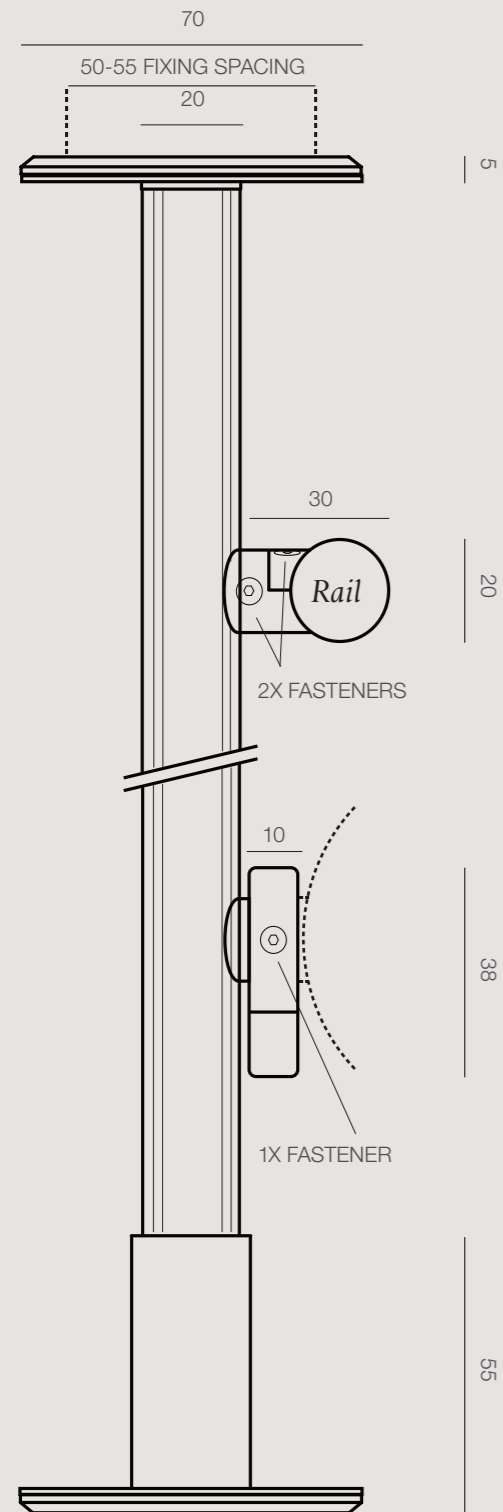

FIXED SURFACE MOUNT

RAIL OVERLAP CONNECTION

LUMINAIRE CONNECTION

ADJUSTABLE SURFACE MOUNT

WALL CONFIGURATIONS



WALL SCONCE



MEDIUM



XXL

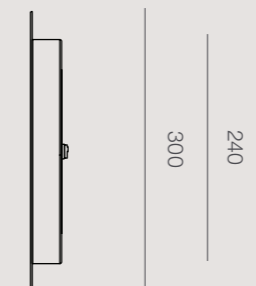

MEDIUM STACK

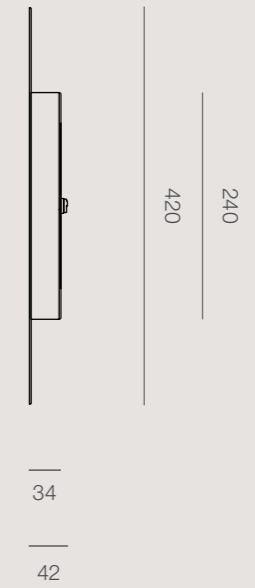

XXL STACK

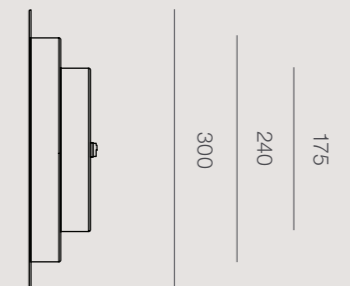

MEDIUM DOUBLE STACK

DATA

TYPOGRAPHY SYSTEM RP-E-1801	RAIL SYSTEM RP-E-1801-S1
DESIGN	STUDIO TRULY TRULY
POWER	UP TO 130W PER CIRCUIT
PRIMARY VOLTAGE (TO DRIVER)	240VAC
SECONDARY VOLTAGE (TO FITTING)	48VDC CONSTANT VOLTAGE
PRODUCT WEIGHT	0.6KG PER 1M
PACKED WEIGHT	APPROX. 1.25KG PER 1M
PACKED DIMENSIONS	1 @ 11 X 11 X CUSTOM LENGTH CM
DRIVER LOCATION	REMOTE OR ON-RAIL
IP RATING	IP20
NOMINAL LIFETIME	50,000 HOURS
APPROVALS	AUSTRALIA, EUROPE

* SPECIFICATIONS DEPEND ON CHOSEN LUMINAIRES, PLEASE SEE INDIVIDUAL DATA TABLES

LUMINAIRES	SPOT RP-E-1802	ROLL RP-E-1803	STAFF RP-E-1804 RP-E-1804W	LAYER RP-E-1805 RP-E-1805W	MINI RP-E-1806 RP-E-1806W	RIB RP-E-1807 RP-E-1807W	DISC RP-E-1808
DESIGN	STUDIO TRULY TRULY						
LIGHTSOURCE	INTEGRATED LED						
POWER	12W	5W	8W	8W	9W	9.5W	13W
LUMENS (DELIVERED)	900lm	450lm	800lm	680lm	710lm	500lm	230lm
COLOUR TEMPERATURE	2700K						
CRI	CRI98	CRI80	CRI90	CRI90	CRI90	CRI80	CRI90
PRODUCT WEIGHT	0.4KG	0.8KG	0.7KG	0.5KG	0.3KG	0.6KG	0.7KG
PACKED WEIGHT	0.6KG	1KG	1KG	0.7KG	0.5KG	0.8KG	1KG
PACKED DIMENSIONS	1 @ 27 X 11 X 9CM	1 @ 16 X 19 X 9CM	1 @ 47 X 12 X 12CM	1 @ 15 X 12 X 12CM	1 @ 15 X 12 X 12CM	1 @ 32 X 20 X 9CM	1 @ 31 X 21 X 10CM
DRIVER LOCATION - WALL	-		REMOTE				-
IP RATING	IP20						
L70	50,000 HOURS						
APPROVALS	AUSTRALIA, EUROPE, AMERICA						



STUDIO TRULY TRULY

Truly Truly is a Rotterdam (NL) based design studio founded by Australian husband and wife design team Joel & Kate Booy. The studio operates on the interface between industry and art. Kate and Joel run a versatile practice, creating textiles, lighting, furniture and spatial installations for internationally renowned design brands.