

INDRE

RP-E-2002



Rakumba

WWW.RAKUMBA.COM
SALES@RAKUMBA.COM

ALL RIGHTS RESERVED © RAKUMBA, 2020
SURREAL VSUALIZATIONS: ALEXIS CHRISTODOULOU

Rakumba







"Indre in Danish means internal. The name stretches back to a time when Copenhagen was a walled city, with an internal and external element. The name seemed to fit perfectly - Two glass elements lightly pressed together encapsulating a beautiful internal glow."

———— Nikolai Kotlarczyk



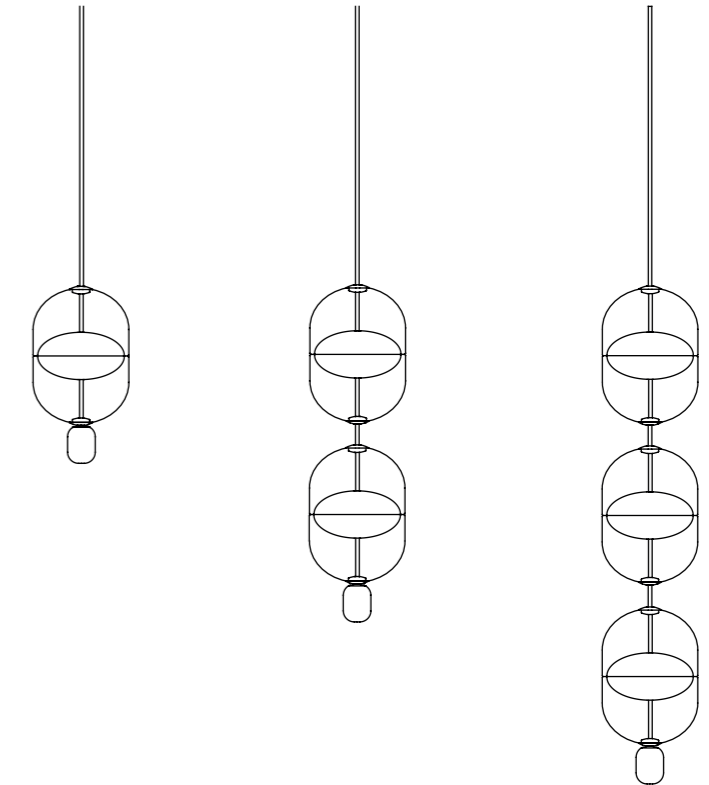

INDRE

RP-E-2002

An ode to the architecture of Copenhagen. Taking its cues from the suspended catenary streetlights and cobbled stone streets of designer Nikolai Kotlarczyk's home city, Indre departs from the purely pared-back and minimal. Drawing on nostalgia and decoration, the collection delivers beauty through its delicately rendered double-wall glass capsules that gently cradle floating internal light. Individual capsules are connected by the graceful lines of a catenary-inspired interlinking rod system anchored with stone or timber detailing.

Indre's extensive modularity allows the series to adapt to all scenarios – refined singular pendants and table lamps, elegant linear compositions for reception, dining or bar settings, and grand multi-tiered chandeliers bringing drama and prestige to large voids.

Aligned with Kotlarczyk's love of tailored decoration, Indre's signature anchors are available in Nero Marquina, Forest Green & Carrara Marble, Travertine or natural Oak, complemented with slimline metalwork in gunmetal, golden, white or custom coloured to suit the project

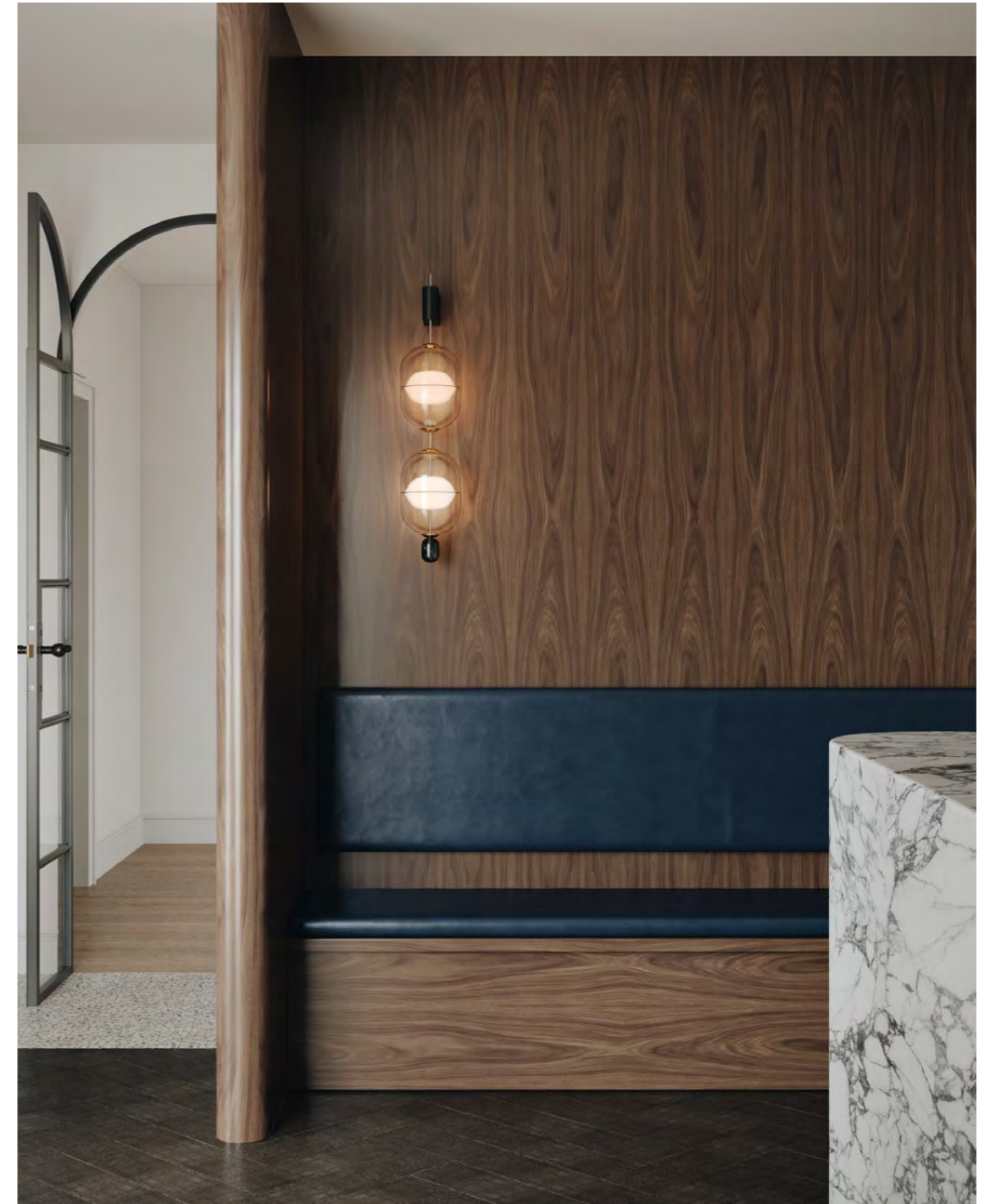

"The key to Indre is elegant versatility. It scales vertically and horizontally in two and three dimensions, producing grand chandeliers, more intimate feature pieces - and everything in between."

————— Nikolai Kotlarczyk

"Perhaps most captivating is the internal light that appears to float, gently cradled within each capsule"

————— Nikolai Kotlarczyk



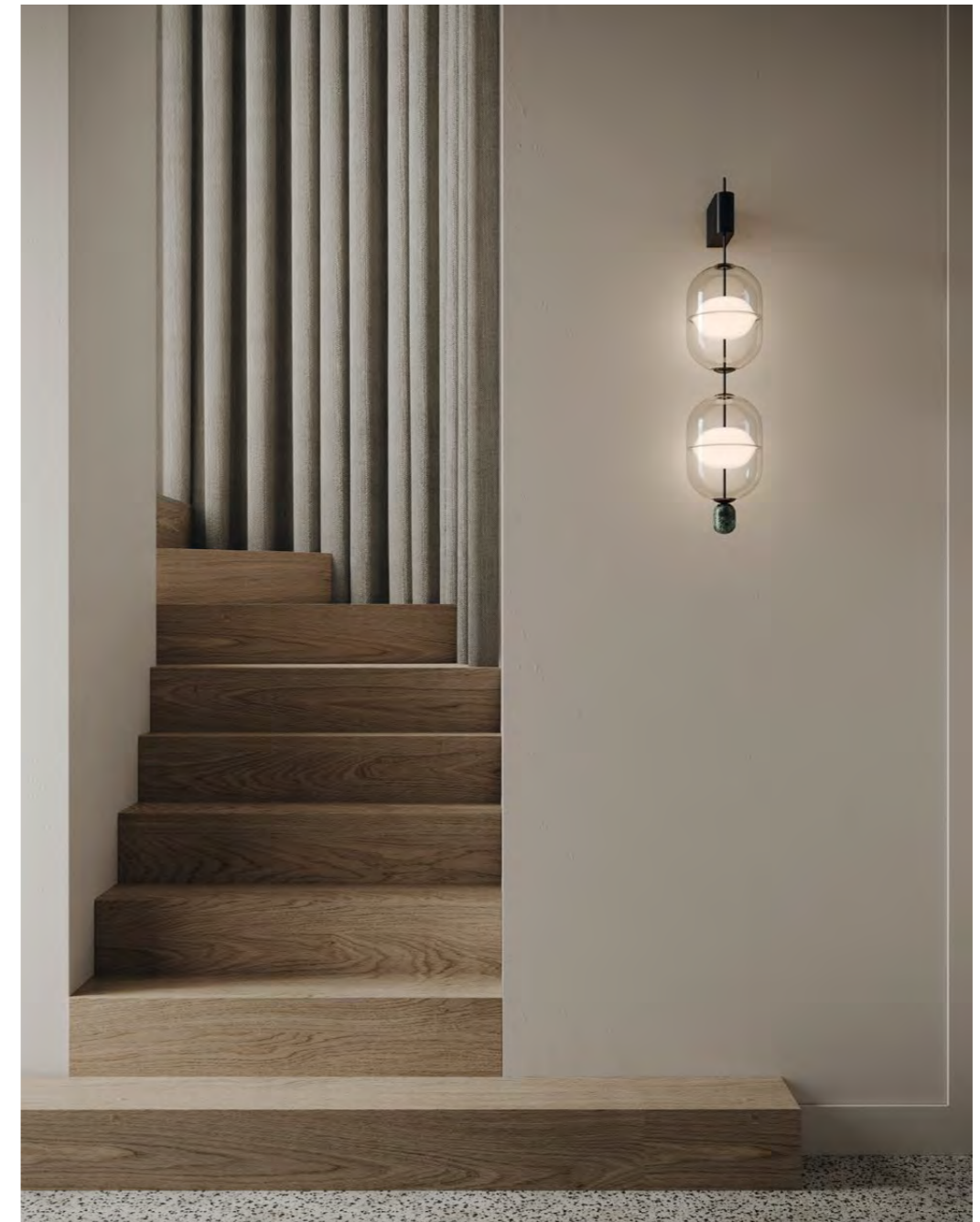



MATERIALS & FINISHES



GUNMETAL



GOLDEN

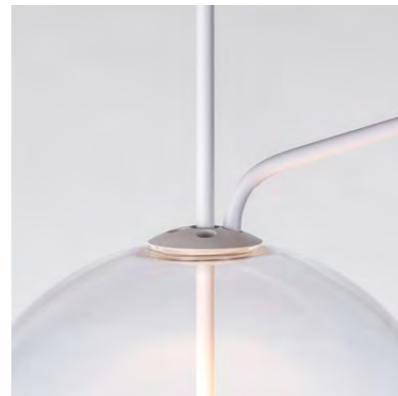

WHITE



CUSTOM

“Colour and material was important for me to further connect the series with interior environments. I wanted to link lighting and architecture to create a system that enhances the spatial environment.”

———— Nikolai Kotlarczyk

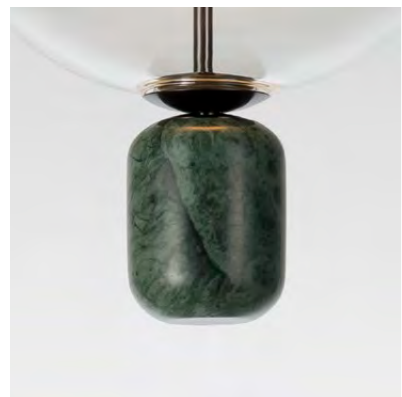

FOREST GREEN MARBLE | SATIN



CLASSIC LIGHT TRAVERTINE (UNFILLED) | HONED



NERO MARQUINA | POLISHED



CARRARA | HONED



OAK | SATIN

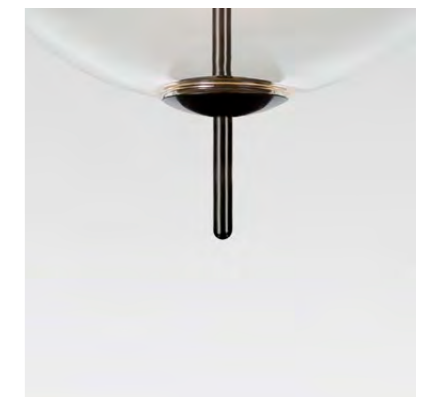

FINIAL-STEM

MATERIALS & FINISHES



MODULAR PENDANT/WALL SYSTEM

CONFIGURATION:	<input type="radio"/>	A - W	
METALWORK:	<input type="radio"/>	GUNMETAL	
	<input type="radio"/>	GOLDEN	
	<input type="radio"/>	WHITE	
	<input type="radio"/>	CUSTOM	
ANCHOR:	<input type="radio"/>	FOREST GREEN MARBLE	
	<input type="radio"/>	CLASSIC LIGHT TRAVERTINE	
	<input type="radio"/>	NERO MARQUINA	
	<input type="radio"/>	CARRARA	
	<input type="radio"/>	OAK	
	<input type="radio"/>	FINIAL-STEM	
DIMMING:	<input type="radio"/>	NON DIMMABLE (REMOTE DRIVER)	
	<input type="radio"/>	PHASE CUT/TRIAC (REMOTE DRIVER)	
	<input type="radio"/>	DALI/SWITCH-DIM (REMOTE DRIVER)	
	<input type="radio"/>	1-10V (REMOTE DRIVER)	
	<input type="radio"/>	CASAMBI WIRELESS	
STANDARD SUSPENSION LENGTH VARIATIONS: (TO TOP OF MODULE)	<input type="radio"/>	160MM	<input type="radio"/>
	<input type="radio"/>	240MM	<input type="radio"/>
	<input type="radio"/>	375MM	<input type="radio"/>
	<input type="radio"/>	455MM	<input type="radio"/>
	<input type="radio"/>	590MM	<input type="radio"/>
	<input type="radio"/>	660MM	<input type="radio"/>
	<input type="radio"/>	670MM	<input type="radio"/>
	<input type="radio"/>	740MM	<input type="radio"/>
	<input type="radio"/>	875MM	<input type="radio"/>
			<input type="radio"/>
			955MM
			1090MM
			1160MM
			1170MM
			1240MM
			1375MM
			1455MM
			1590MM
			1670MM
			CUSTOM
SEAMLESS CANOPY:	<input type="radio"/>	BLACK	
	<input type="radio"/>	WHITE	
	<input type="radio"/>	SILVER	
	<input type="radio"/>	BRASS	

TABLE LAMP

METALWORK:	<input type="radio"/>	GUNMETAL
	<input type="radio"/>	GOLDEN
	<input type="radio"/>	WHITE
	<input type="radio"/>	CUSTOM
ANCHOR/BASE:	<input type="radio"/>	FOREST GREEN MARBLE
	<input type="radio"/>	CLASSIC LIGHT TRAVERTINE
	<input type="radio"/>	NERO MARQUINA
	<input type="radio"/>	CARRARA
	<input type="radio"/>	OAK
DIMMING:	<input type="radio"/>	INLINE SWITCH DIMMING/CORD AND PLUG

CONFIGURATIONS

PENDANT

A

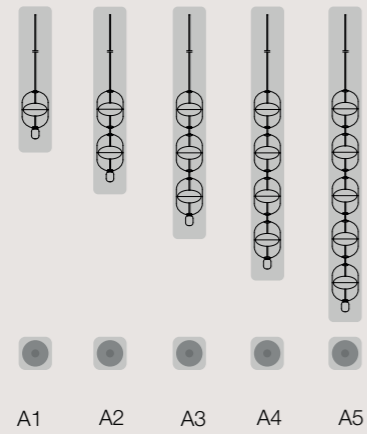

LINEAR CHANDELIERS

B

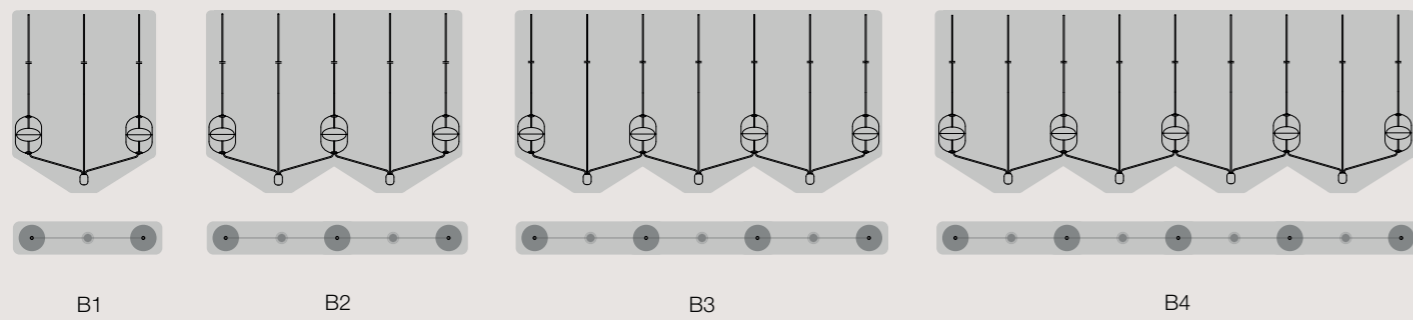

C

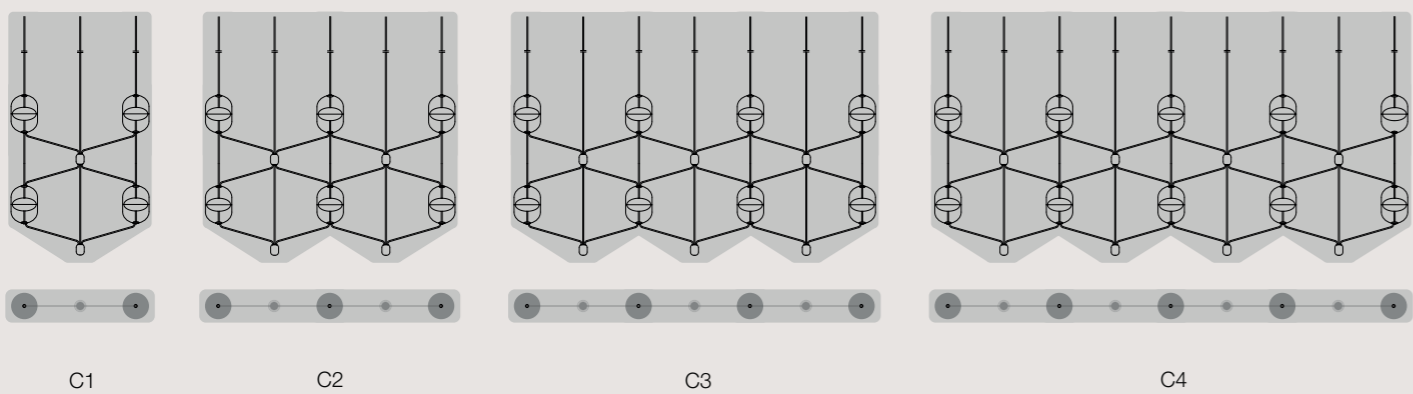

D

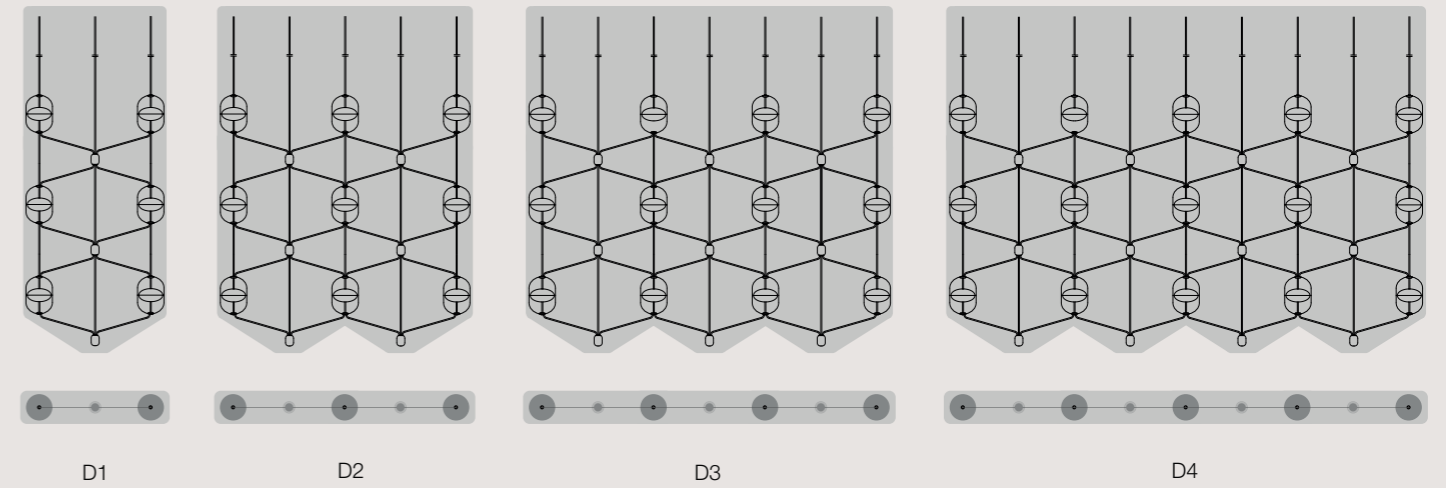

E

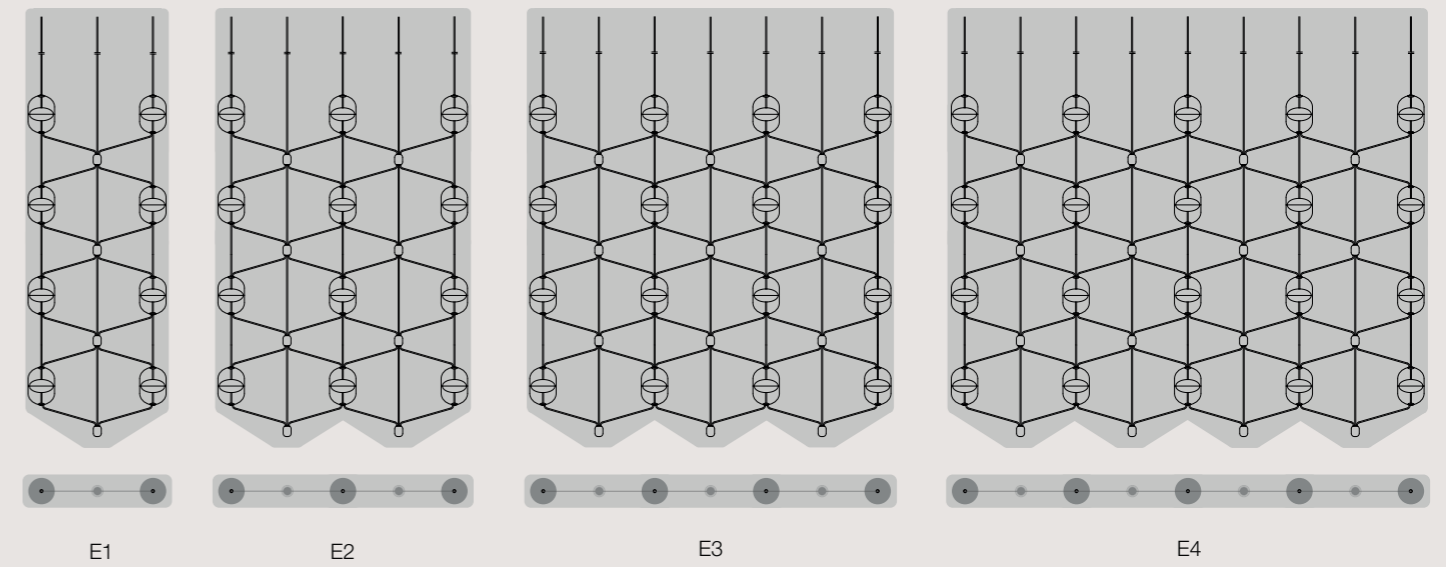

CONFIGURATIONS

LINEAR CHANDELIERS

F

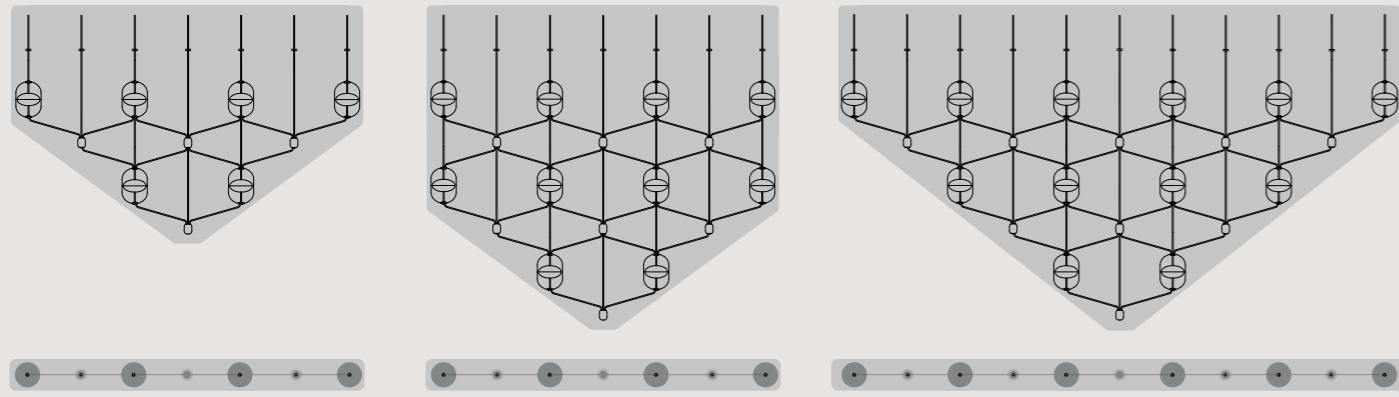

F1

F2

F3

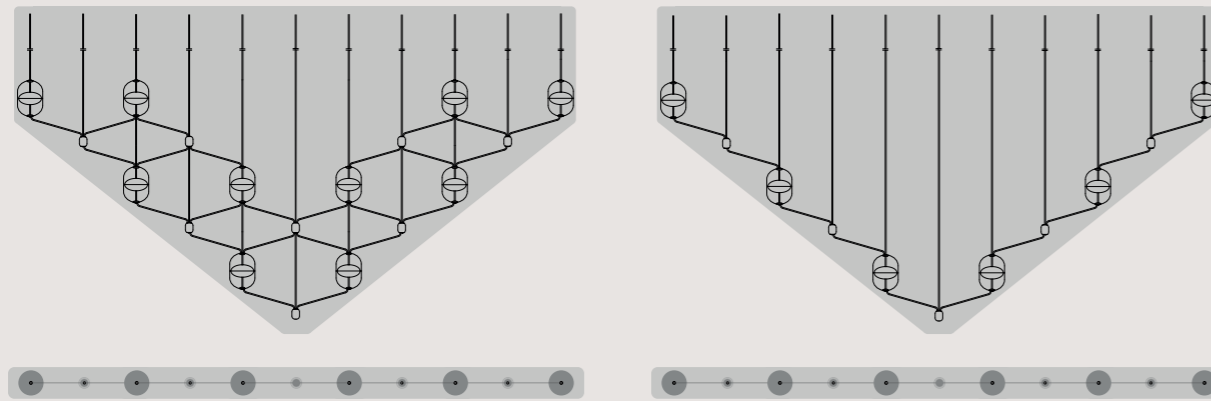

F4

F5

G

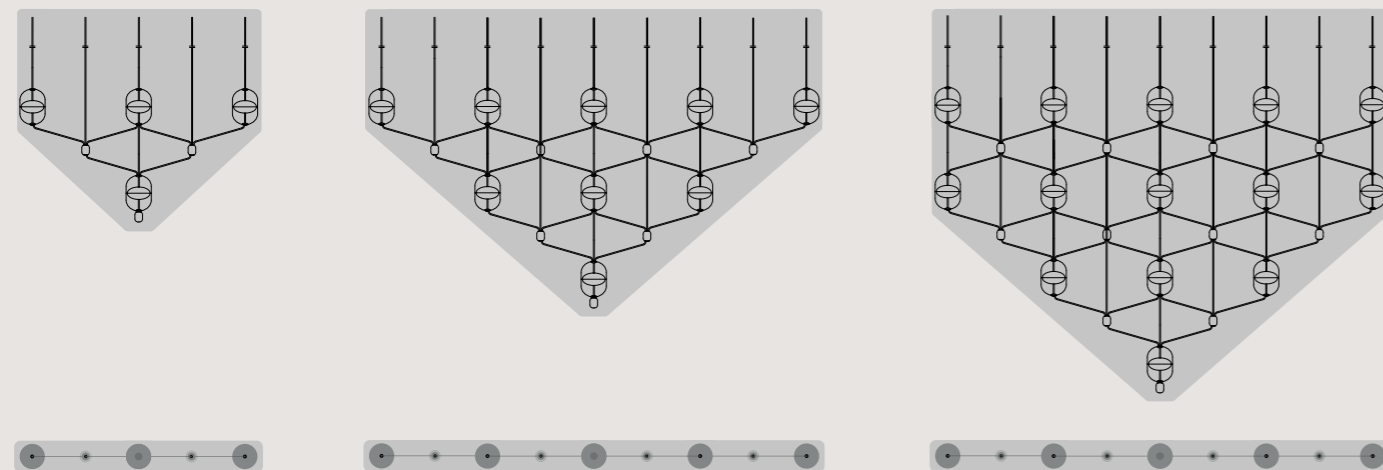

G1

G2

G3

H

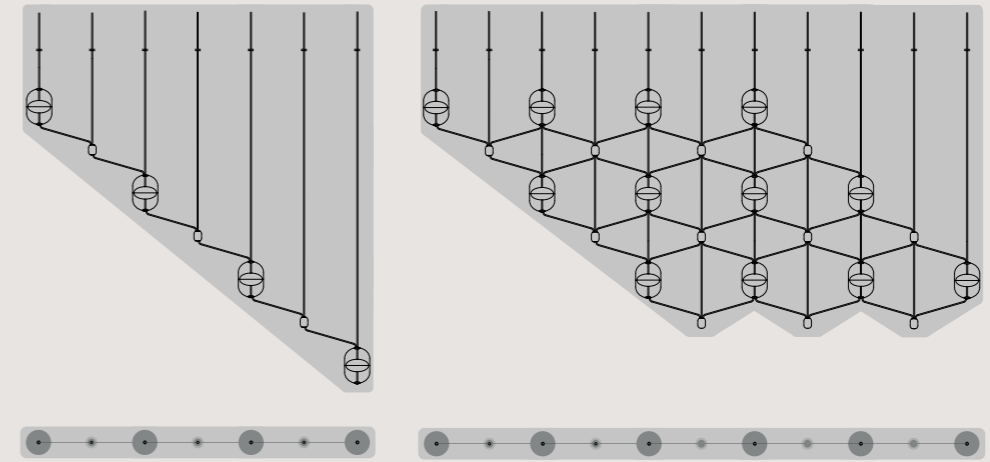

H1

H2

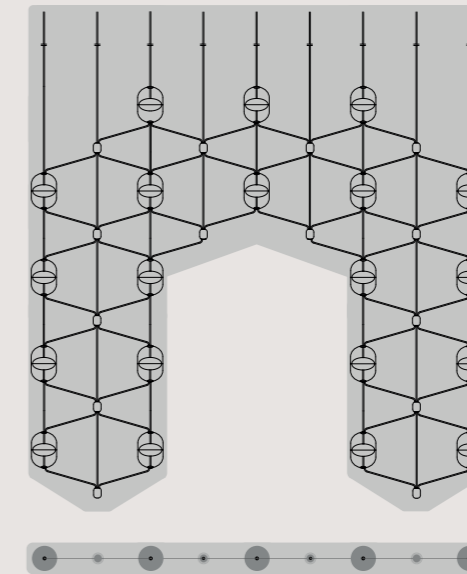

H3

CONFIGURATIONS

CHANDELIERS

I

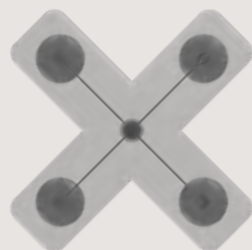
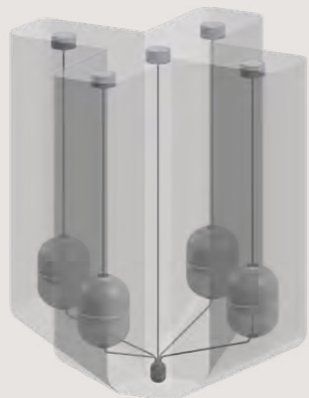

J

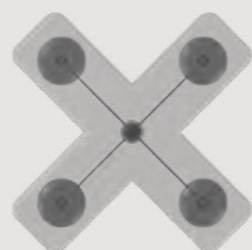
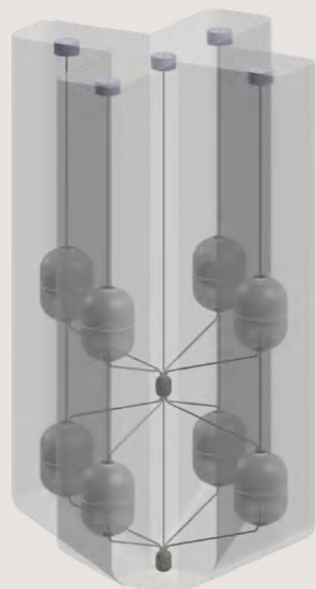

K

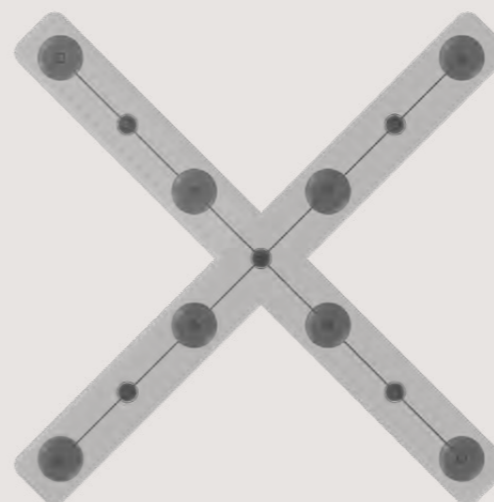
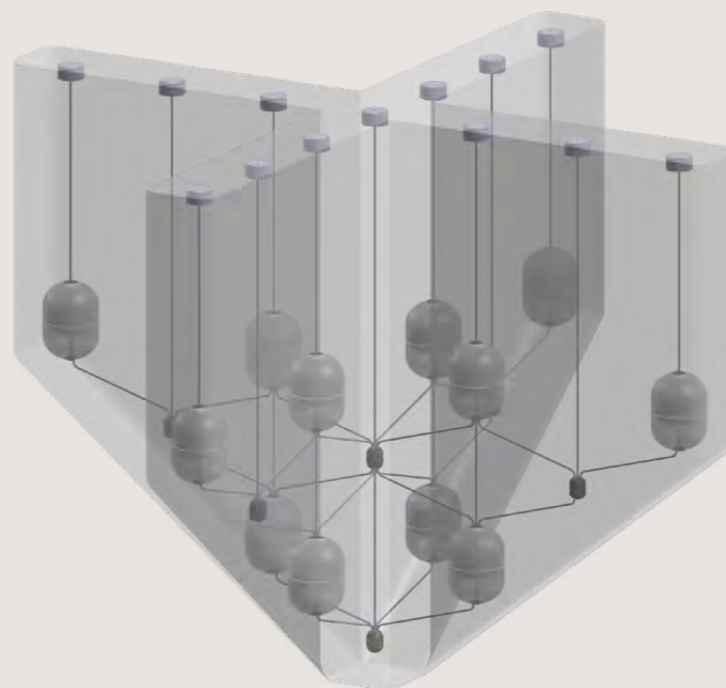

L

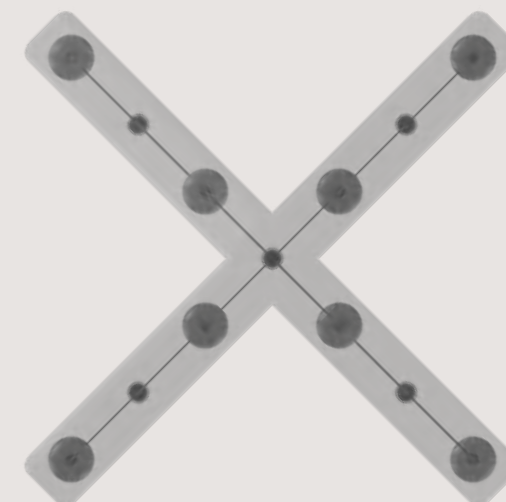
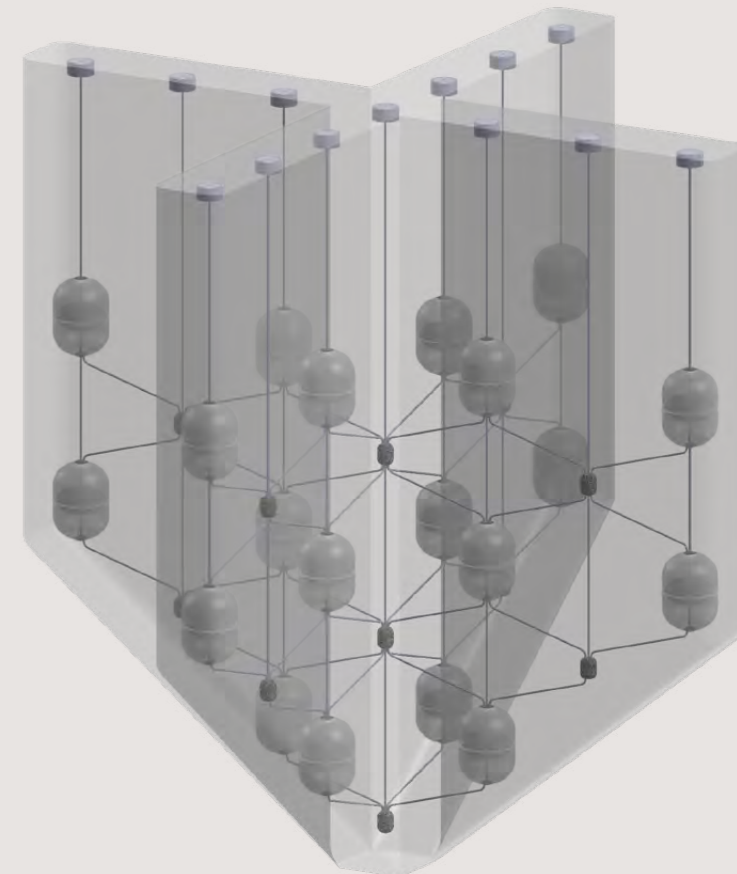

CONFIGURATIONS

CHANDELIERS

M

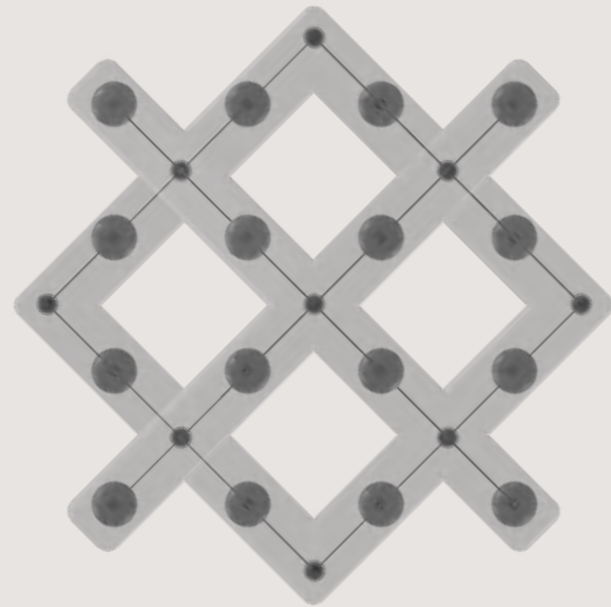
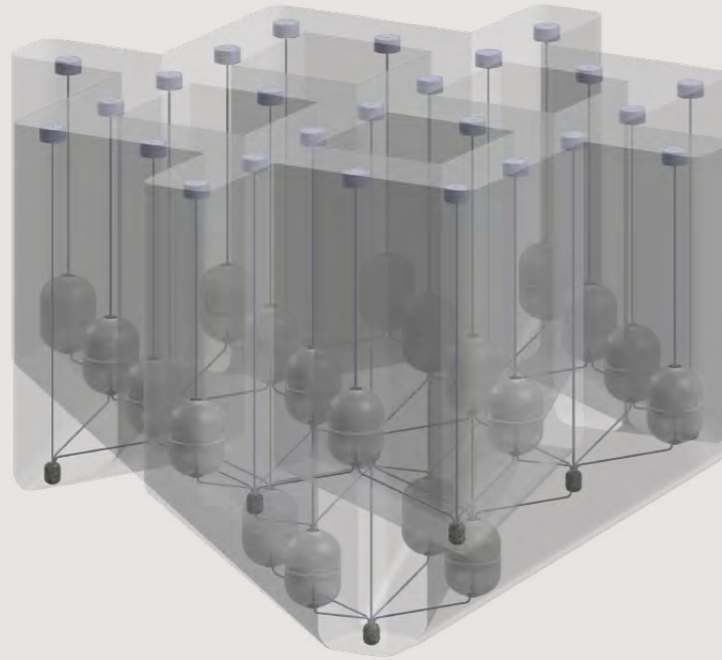

N

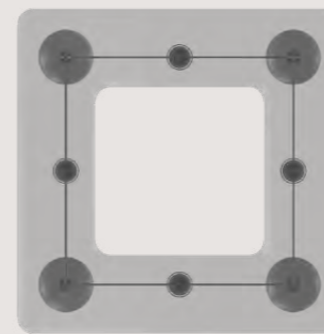
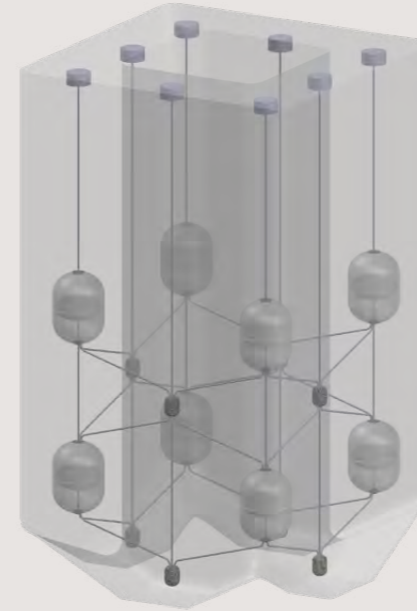

O

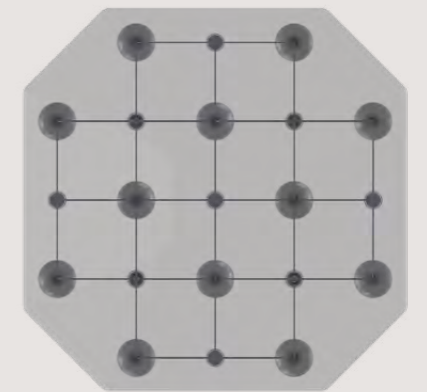
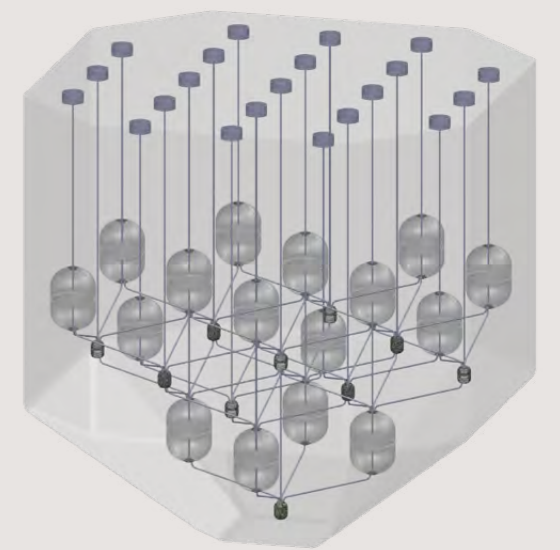

CONFIGURATIONS

CHANDELIERS

P

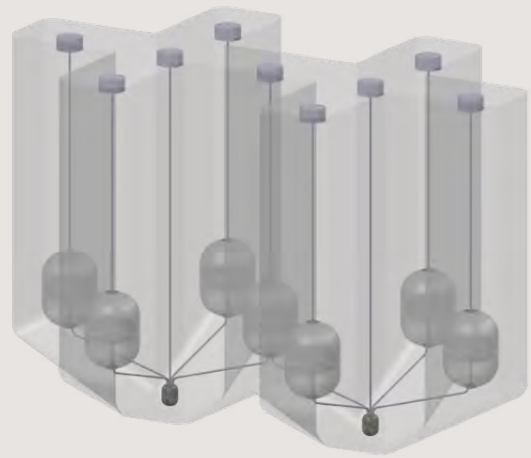

Q

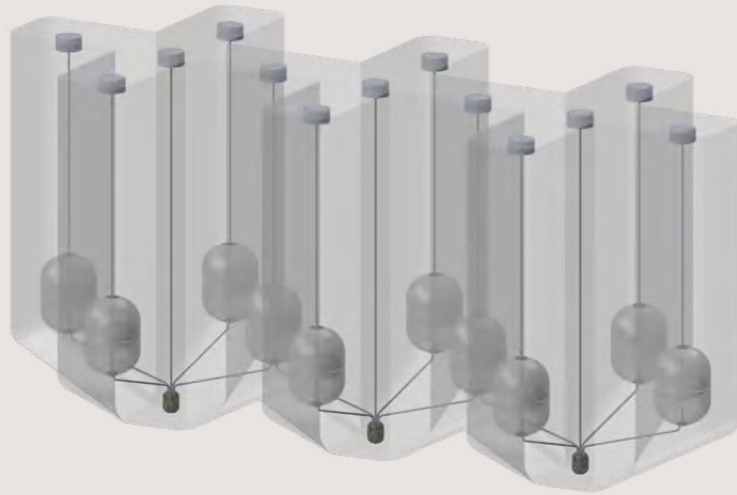

R

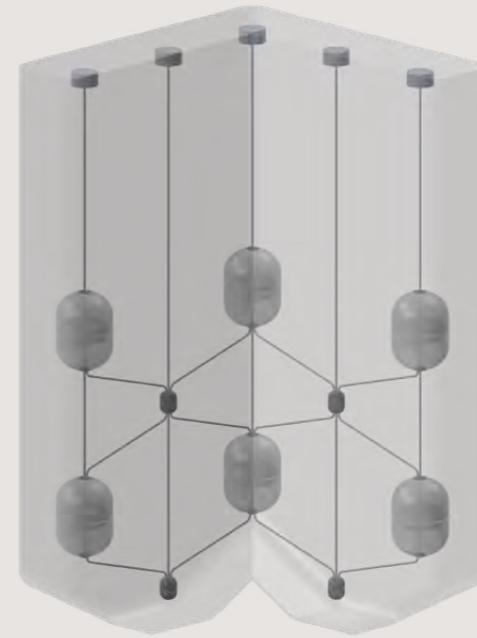

S

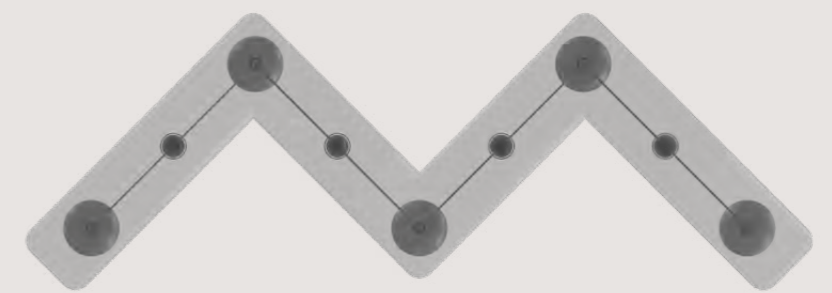
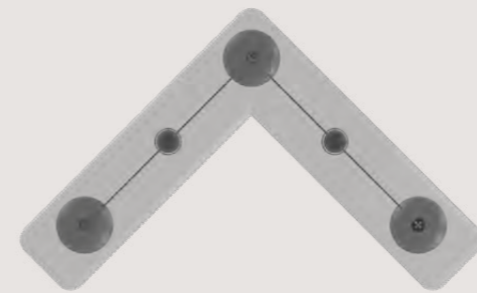
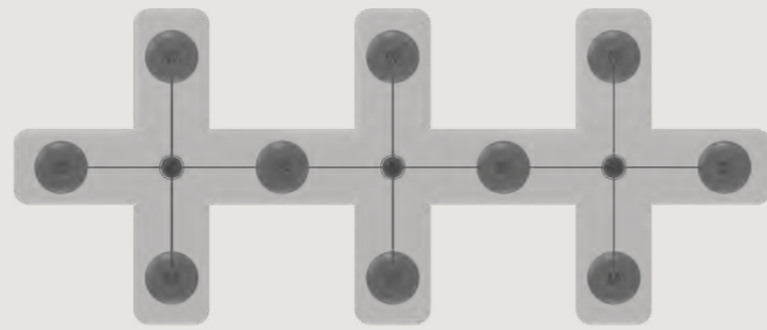
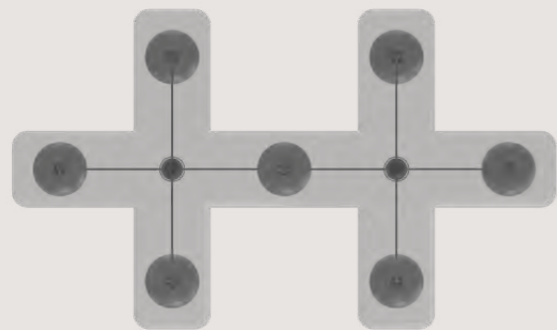
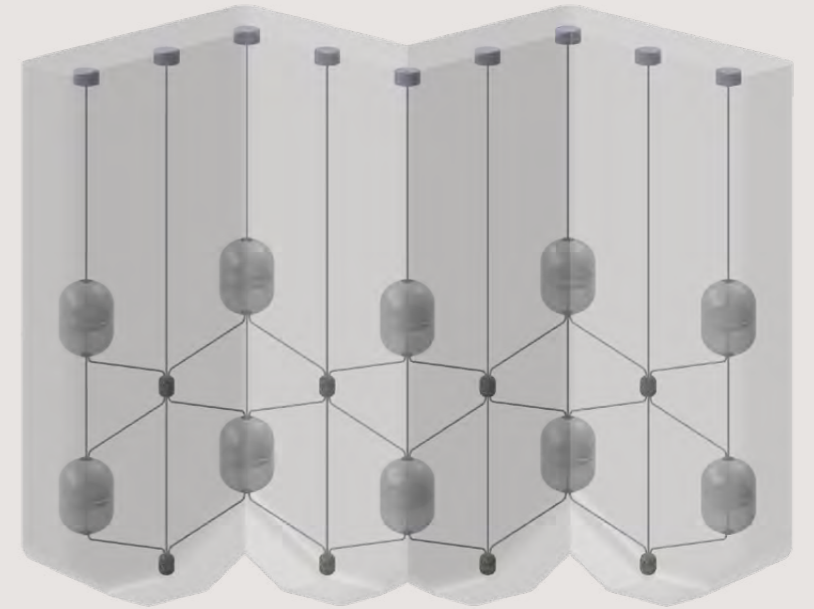

CONFIGURATIONS

CHANDELIERS

T

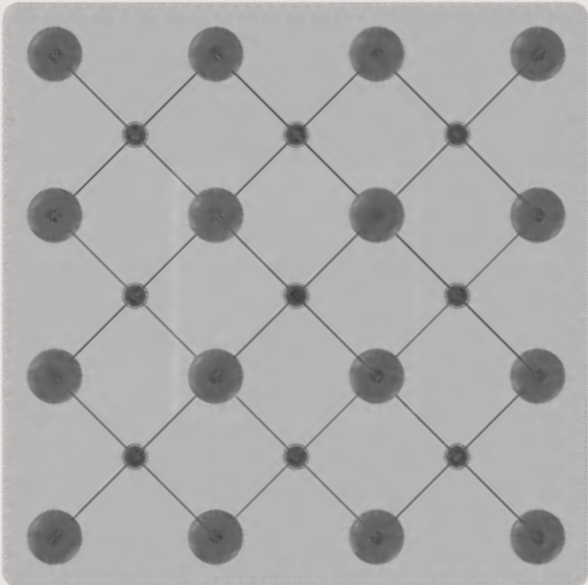
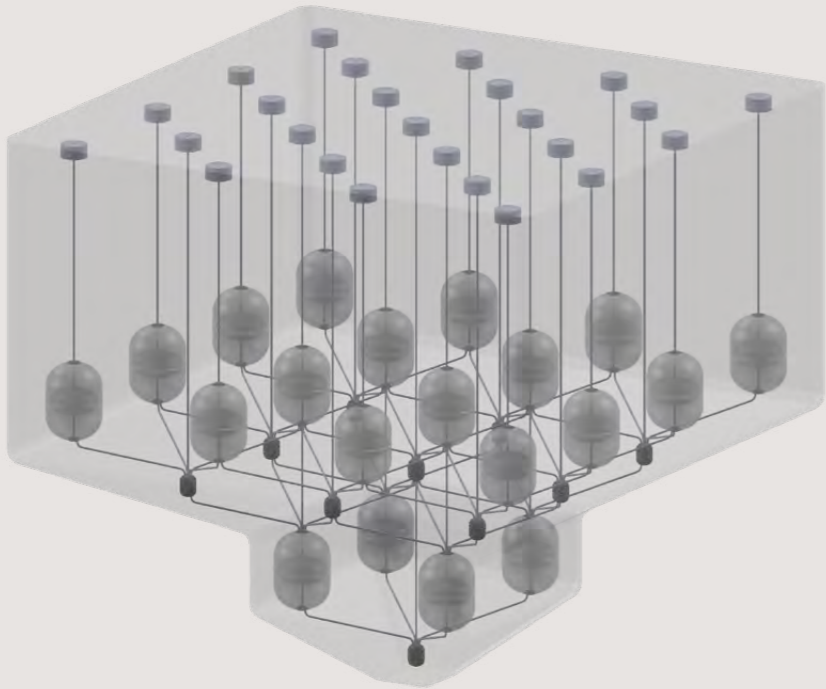

U

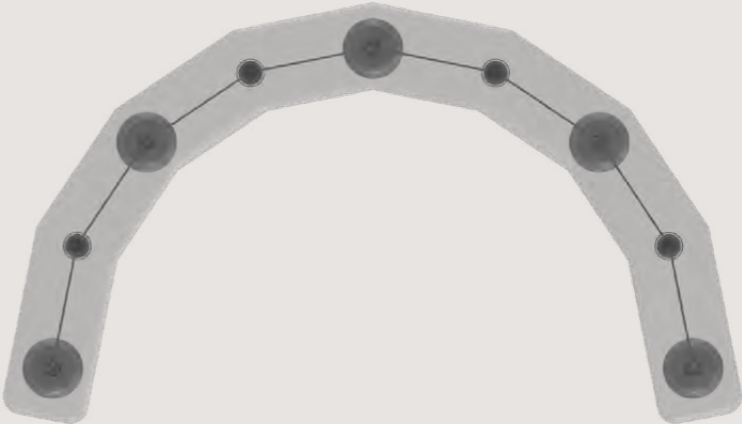
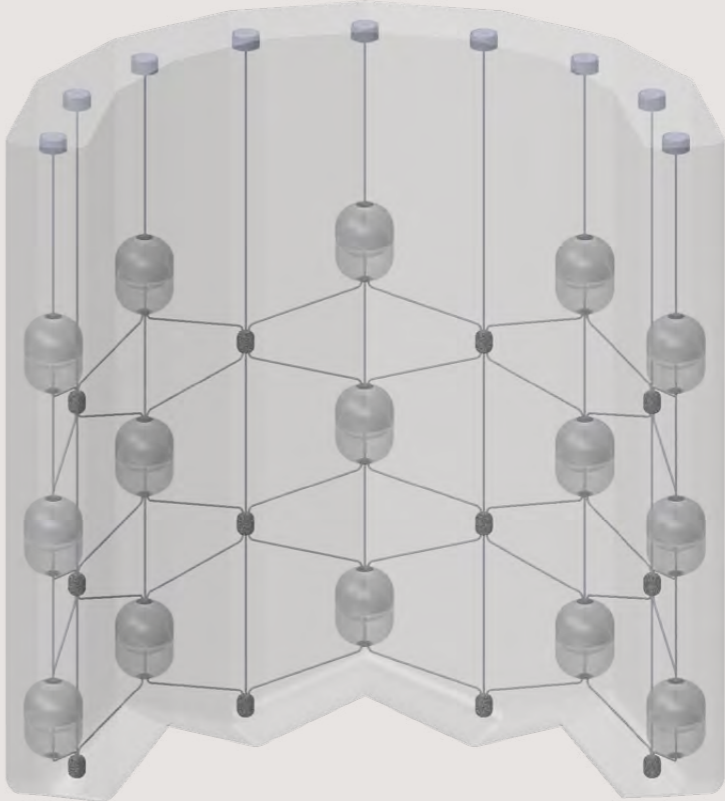

CONFIGURATIONS

CHANDELIERS

V

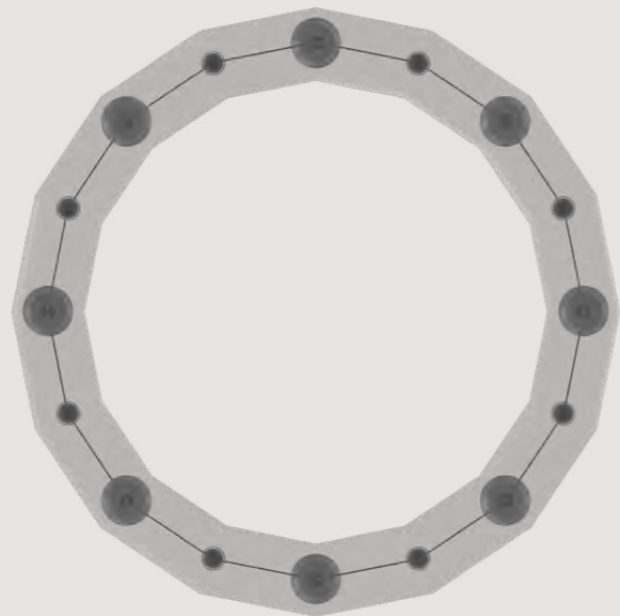
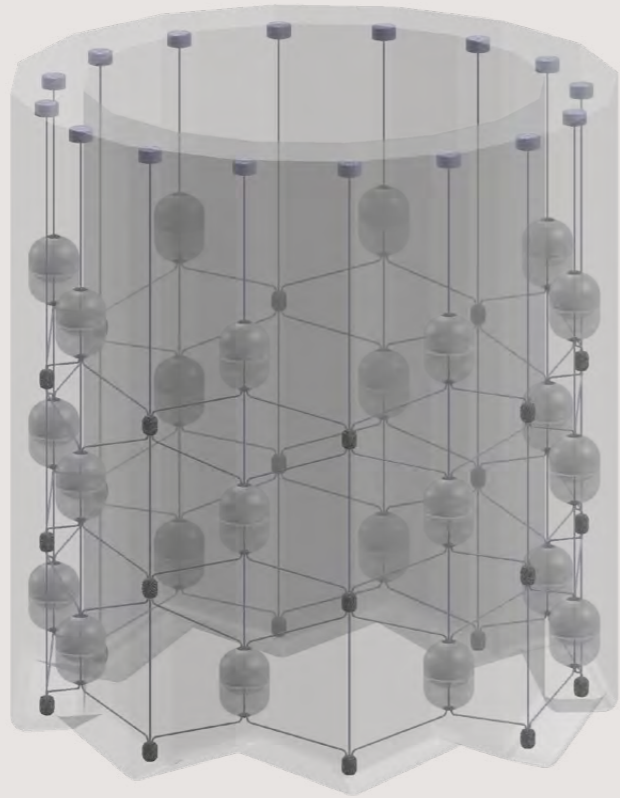

WALL

W

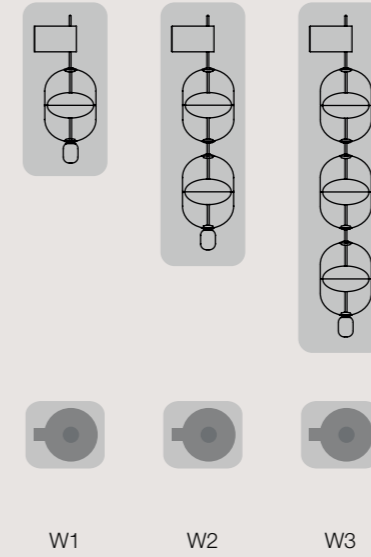

DIMENSIONS

MODULE

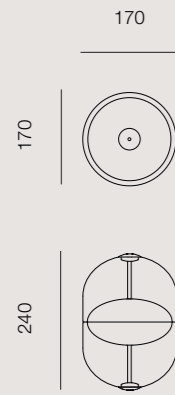
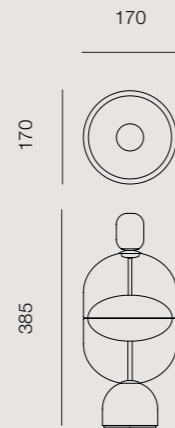
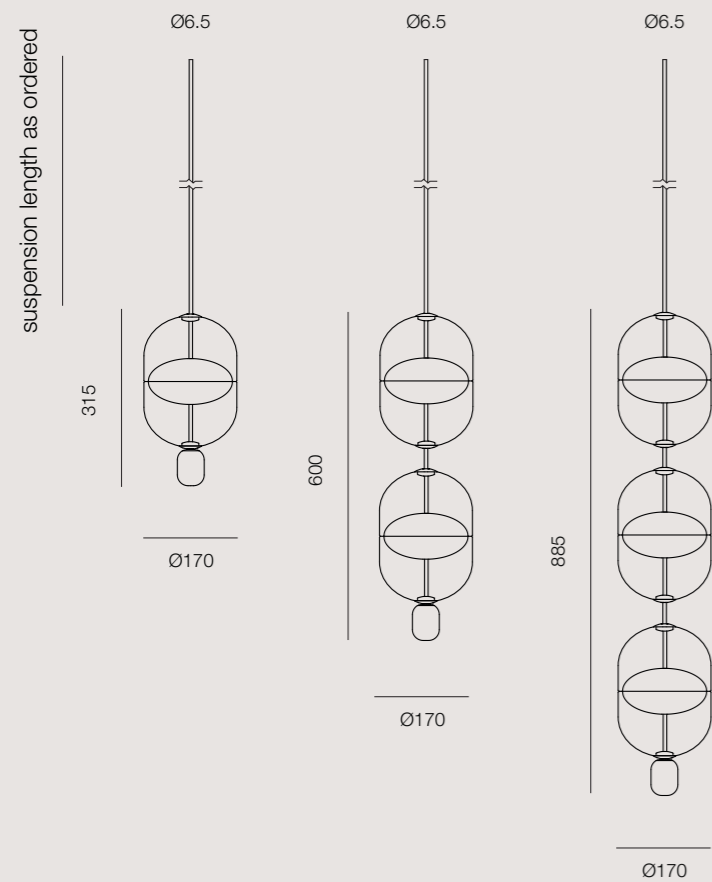

TABLE LAMP



PENDANT

MAXIMUM OF 8 LIGHT MODULES PER VERTICAL DROP
MAXIMUM CONFIGURATION HEIGHT 6.5M



WALL

MAXIMUM OF 7 LIGHT MODULES PER VERTICAL DROP

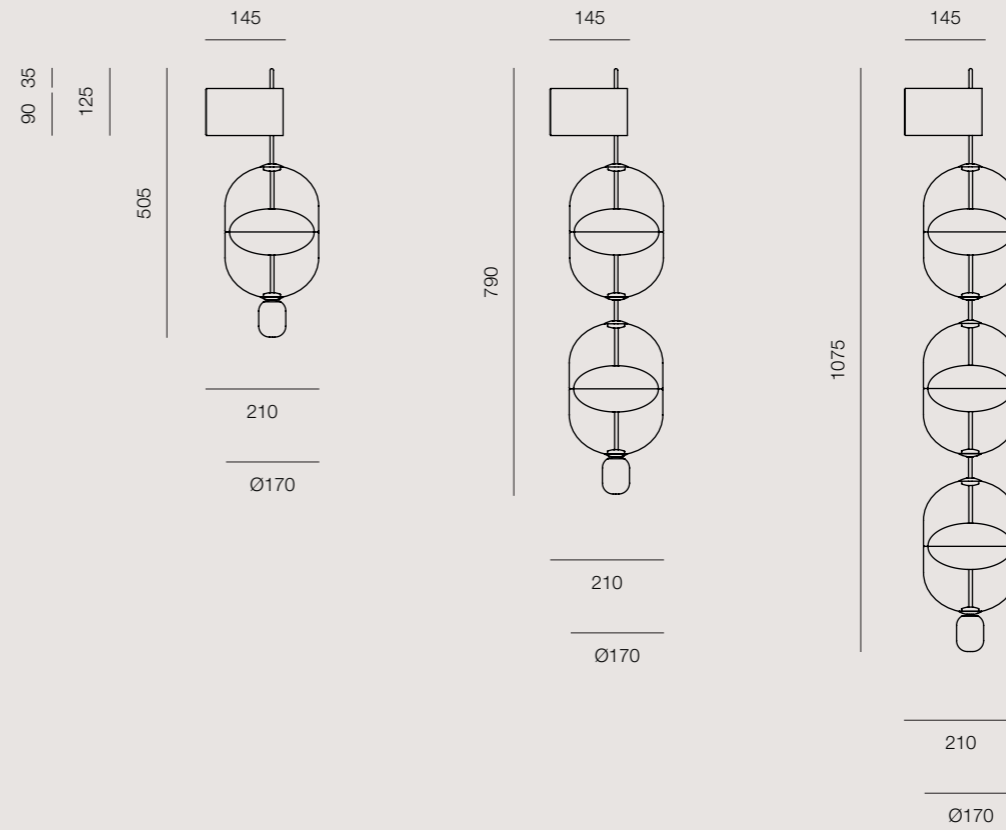

SYSTEM

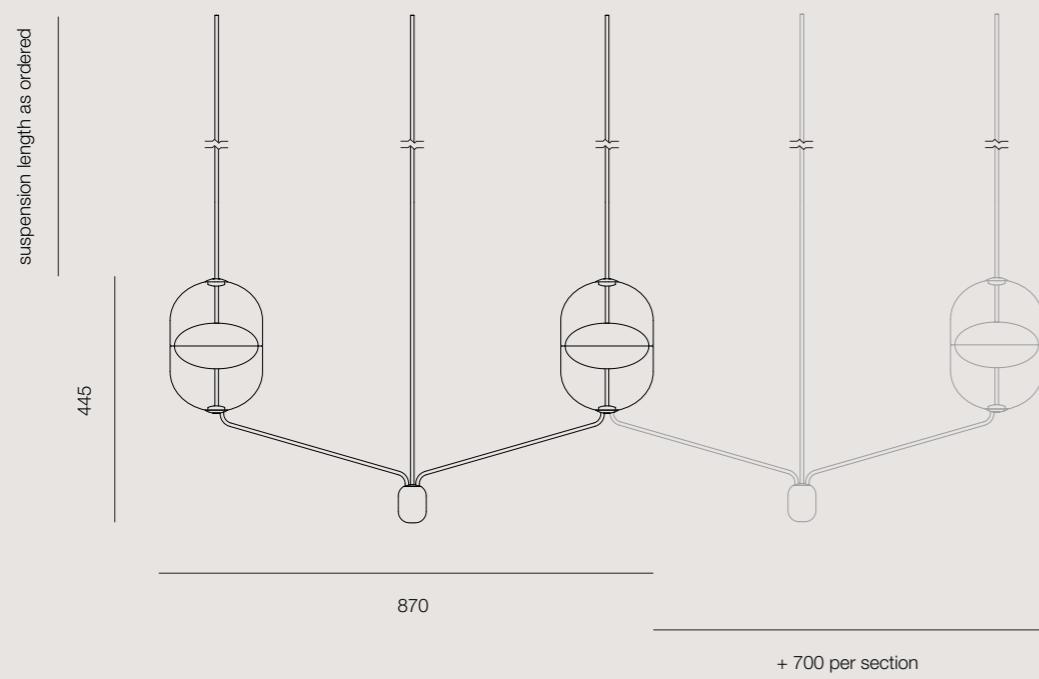
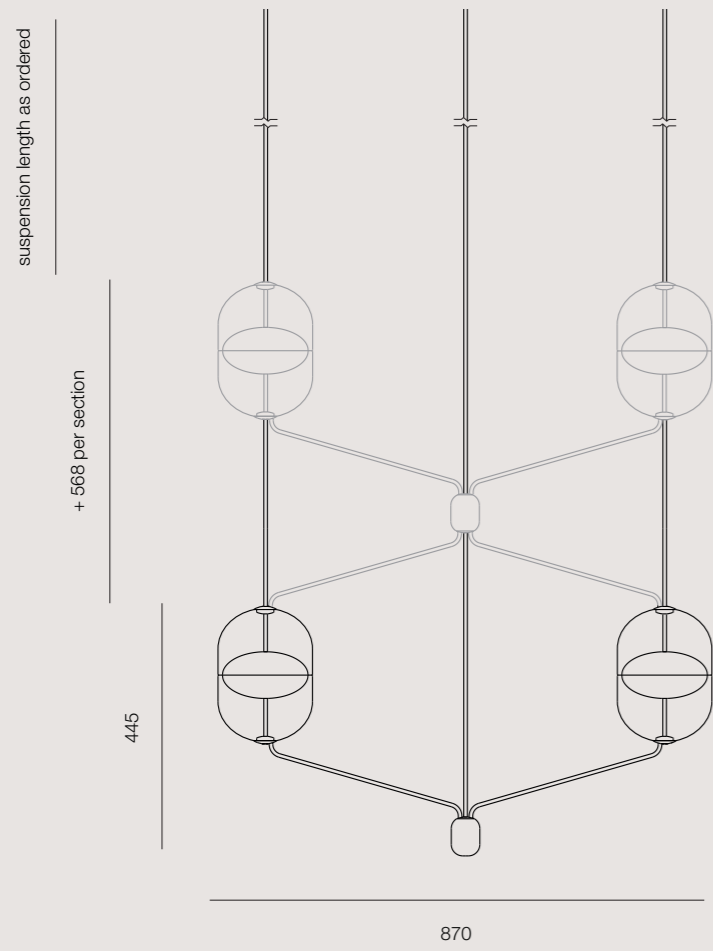

DETAIL

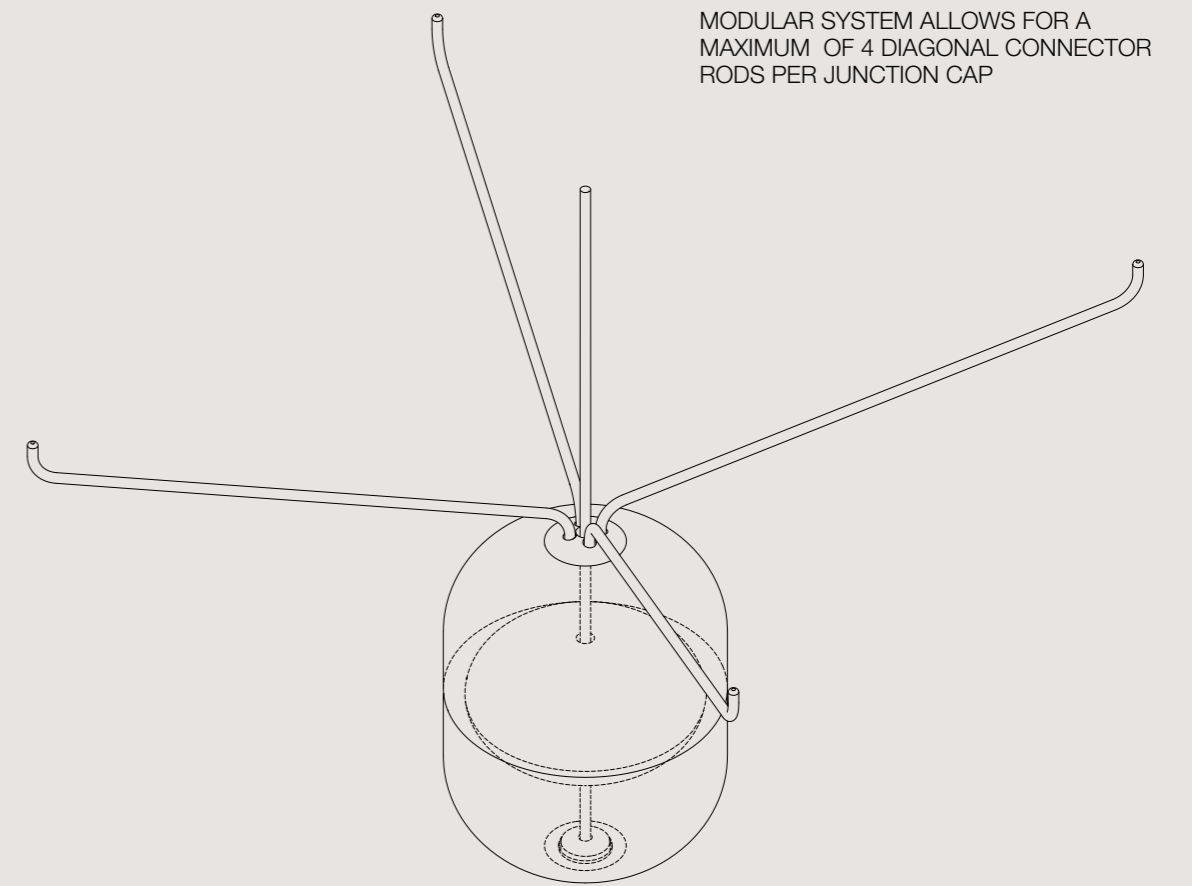

DIAGONAL CONNECTOR RODS CAN PIVOT
FREELY - ALLOWS FOR CURVED AND
CIRCULAR CONFIGURATIONS

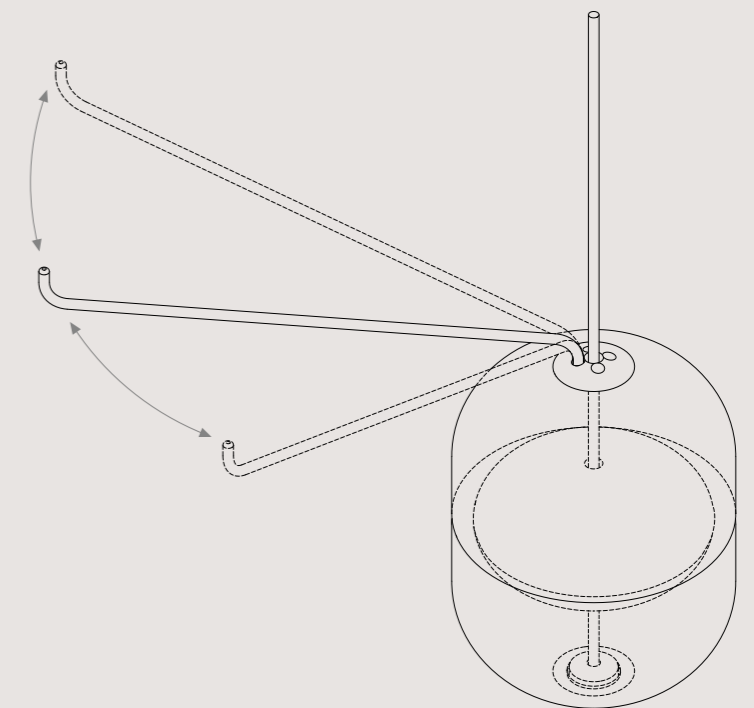

DATA

RP-E-2002	SINGLE MODULE	TABLE LAMP
LIGHTSOURCE	INTEGRATED LED	
POWER	6.5W	6.5W
LUMENS (SOURCE)	870lm	870lm
LUMENS (DELIVERED)	-	-
COLOUR TEMPERATURE	2700K	
CRI	CRI90	
PRIMARY VOLTAGE (TO DRIVER)	220-240VAC	
SECONDARY VOLTAGE (TO FITTING)	24VDC CONSTANT VOLTAGE	
PRODUCT WEIGHT	0.9kg	2.3kg
PACKED WEIGHT (FITTING)	-	-
PACKED DIMENSIONS	-	-
DRIVER LOCATION	REMOTE	CORDSET DRIVER
IP RATING	IP20	
L70	50,000 HOURS	
APPROVALS	AUSTRALIA, EUROPE	

SINGLE DRIVER POWERS UP TO 4 LIGHT MODULES

LARGER DRIVERS (5-10 MODULES) AVAILABLE ON REQUEST

CONFIGURATION	NUMBER OF MODULES	PRODUCT DIMENSIONS	PRODUCT WEIGHT	PACKED DIMENSIONS	PACKED WEIGHT
A	1	315 x 170 x 170mm	2kg	-	-
	2	600 x 170 x 170mm	3kg	-	-
	3	885 x 170 x 170mm	4kg	-	-
	4	1170 x 170 x 170mm	5kg	-	-
	5	1455 x 170 x 170mm	6kg	-	-
B	1	445 x 870 x 170mm	4kg	-	-
	2	445 x 1570 x 170mm	5kg	-	-
	3	445 x 2270 x 170mm	7kg	-	-
	4	445 x 2970 x 170mm	9kg	-	-
C	1	1013 x 870 x 170mm	6kg	-	-
	2	1013 x 1570 x 170mm	9kg	-	-
	3	1013 x 2270 x 170mm	12kg	-	-
	4	1013 x 2970 x 170mm	16kg	-	-
D	1	1581 x 870 x 170mm	8kg	-	-
	2	1581 x 1570 x 170mm	13kg	-	-
	3	1581 x 2270 x 170mm	18kg	-	-
	4	1581 x 2970 x 170mm	23kg	-	-
E	1	2149 x 870 x 170mm	11kg	-	-
	2	2149 x 1570 x 170mm	17kg	-	-
	3	2149 x 2270 x 170mm	23kg	-	-
	4	2149 x 2970 x 170mm	29kg	-	-
F	1	1013 x 2270 x 170mm	10kg	-	-
	2	1581 x 2270 x 170mm	15kg	-	-
	3	1581 x 3670 x 170mm	19kg	-	-
	4	1581 x 3670 x 170mm	16kg	-	-
	5	1581 x 3670 x 170mm	11kg	-	-
G	1	890 x 1570 x 170mm	7kg	-	-
	2	1458 x 2970 x 170mm	14kg	-	-
	3	2026 x 2970 x 170mm	21kg	-	-
H	1	1956 x 2270 x 170mm	7kg	-	-
	2	1581 x 3670 x 170mm	20kg	-	-
	3	2717 x 2970 x 170mm	28kg	-	-

DATA

CONFIGURATION	NUMBER OF MODULES	PRODUCT DIMENSIONS	PRODUCT WEIGHT	PACKED DIMENSIONS	PACKED WEIGHT
I	4	445 x 870 x 870mm	6kg	-	-
J	8	1013 x 870 x 870mm	10kg	-	-
K	12	1013 x 2270 x 2270mm	18kg	-	-
L	20	1581 x 2270 x 2270mm	28kg	-	-
M	20	1013 x 2270 x 2270mm	30kg	-	-
N	8	1013 x 870 x 870mm	14kg	-	-
O	16	1013 x 1570 x 1570mm	26kg	-	-
P	7	445 x 1570 x 870mm	10kg	-	-
Q	10	445 x 2270 x 870mm	14kg	-	-
R	6	1013 x 1160 x 665mm	9kg	-	-
S	10	1013 x 2150 x 665mm	16kg	-	-
T	20	1013 x 2270 x 2270mm	31kg	-	-
U	15	1581 x 1057 x 1960mm	23kg	-	-
V	24	1581 x 1960 x 1960mm	39kg	-	-
W	1	505 x 170 x 210mm	3.5kg	-	-
	2	790 x 170 x 210mm	4.5kg	-	-
	3	1075 x 170 x 210mm	5.5kg	-	-



NIKOLAI KOTLARCZYK

The studio of Nikolai Kotlarczyk extends across interior product design - from decorative pieces to more industrial focused work. What unites his work is a geometric sensibility based around the design elements of symmetry and balance, along with references to historical and geographical ingredients - most predominately architectural. Aiming to simplify and present these references in a contemporary way, his work often contains a sense of nostalgia within a style that is refined yet decorative.

Nikolai approaches the importance of sustainability in contemporary design through a combination of quality craftsmanship, durable natural materials, and a unique design language to create work that does not contribute to a throw-away culture.

