

RP-E-1503

**Bella Series**



# Bella Series

## ORDERING OPTION 1 - DIMENSIONS

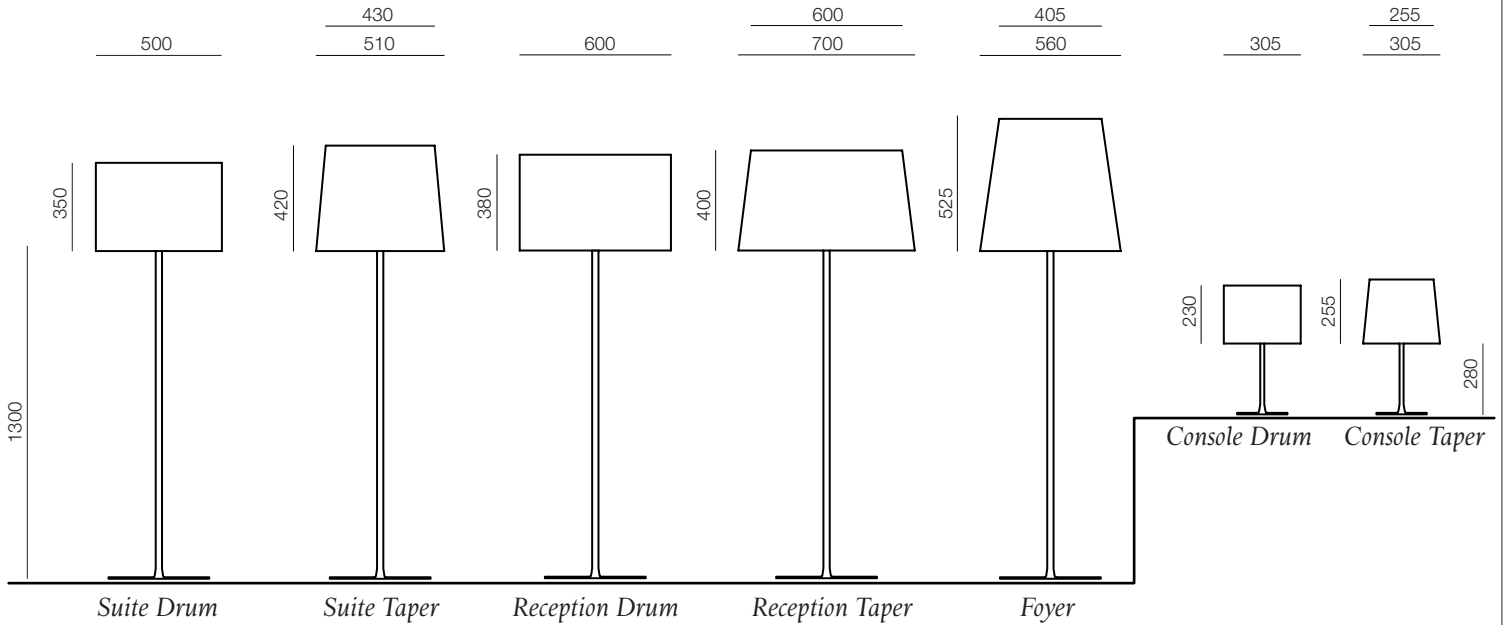

CUSTOM SIZES AVAILABLE ON REQUEST  
DIMENSIONS IN MILLIMETRES

## ORDERING OPTION 2 - FINISH



## ORDERING OPTION 3 - STAND COLOUR (CUSTOM COLOURS ALSO AVAILABLE)

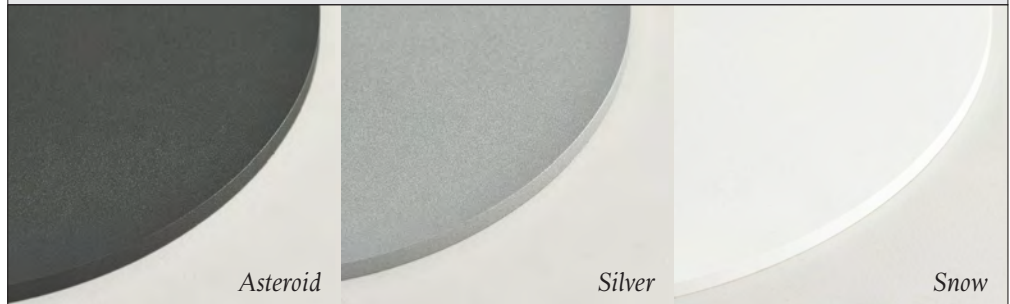

## ORDERING OPTION 4 - FLEX COLOUR



## ORDERING OPTION 5- SWITCH OR DIMMER



## PRODUCT TECHNICAL SPECIFICATION

NAME: BELLA  
 DESIGN: RAKUMBA  
 STYLE: TABLE AND FLOOR LAMP  
 MATERIALS & FINISH: STAND - POWDERCOATED STEEL AND ALUMINIUM // POLISHED BRASS DETAIL (OPTIONAL)  
 SHADE - CUSTOMISABLE FABRIC (CONTACT RAKUMBA FOR EXTENSIVE RANGE OF OPTIONS)  
 LIGHT SOURCE: 1 X E27 LAMPHOLDER // 240V // CFL BULB RECOMMENDED MAX. 14W  
 CORDSET: STANDARD: 2m CLEAR PLASTIC FLEX WITH INLINE OR FOOT SWITCH  
 OPTIONAL: 2m TEXTILE SLEEVED FLEX WITH INLINE OR FOOT RELCO DIMMER

Rakumba has been producing custom-made feature lighting for the Australian design industry since 1968. Collaborating with designers across a wide range of sectors from commercial to residential, we take pride in our bespoke service, attention to design detailing and ability to deliver on any scale of project.

RP-E-1418P

## Canterbury Pendant



# Canterbury Pendant

## DIMENSIONS

CANTERBURY600

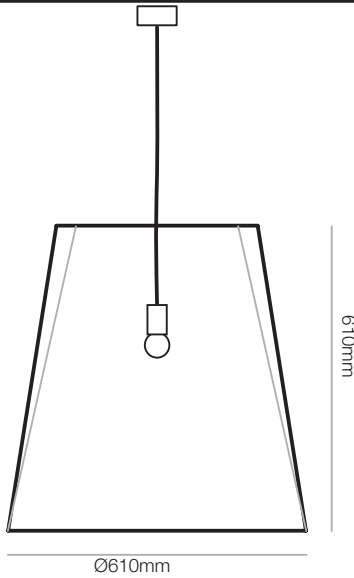

CANTERBURY800

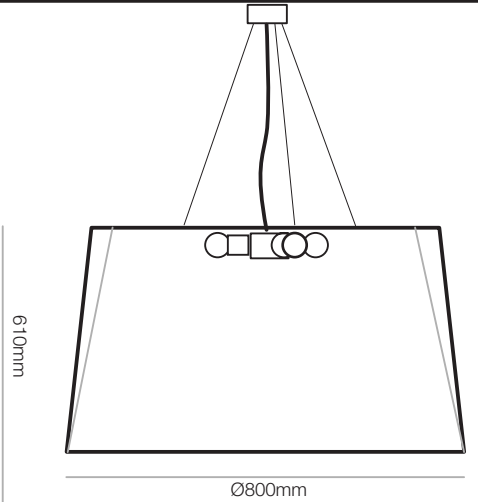

CANTERBURY1000

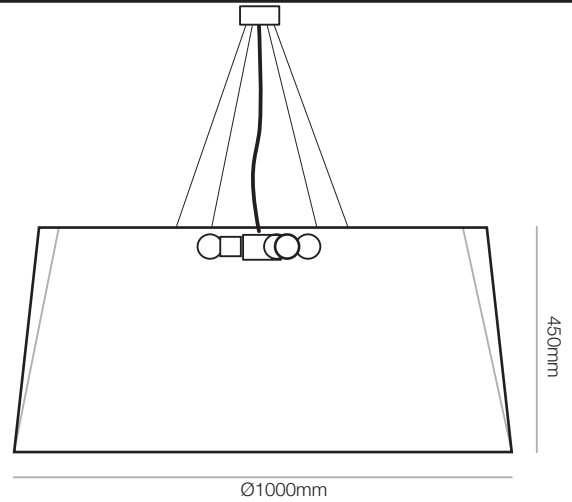

DIMENSIONS ARE FULLY CUSTOMISABLE

## PRODUCT TECHNICAL SPECIFICATION

NAME: CANTERBURY  
STYLE: PENDANT

MATERIALS & FINISH: EXTERIOR - MATERIAL FROM RAKUMBA SELECTION OR CUSTOM BONDED FABRIC  
INTERIOR - CUSTOMER SPECIFIED SILK, HAND MADE RUFFLE PLEAT  
DIFFUSER - OPTIONAL FLOATING DIFFUSER

LIGHT SOURCE: CANTERBURY600 - 1 X E27 // 240v // LED OR CFL GLOBES RECOMMENDED MAX. 24W  
CANTERBURY800 - 3 X E27 HUB // 240v // LED OR CFL GLOBES RECOMMENDED MAX. 24W  
CANTERBURY1000 - 3 X E27 HUB // 240v // LED OR CFL GLOBES RECOMMENDED MAX. 24W  
OPTIONAL - 2 x TRIDONIC LED DISKS (UP+DOWN CONFIG.) //240V DRIVER // 29.2W PER DISK // 3800lm PER DISK // 3000K

SUSPENSION: CANTERBURY600 - BRAIDED TEXTILE FLEX // SEAMLESS CANOPY  
CANTERBURY800 & 1000 - STEEL CABLES // BRAIDED TEXTILE FLEX // SEAMLESS CANOPY

Rakumba has been producing custom-made feature lighting for the Australian design industry since 1968. Collaborating with designers across a wide range of sectors from commercial to residential, we take pride in our bespoke service, attention to design detailing and ability to deliver on any scale of project.

RP-E-1402P

**Cirque Pendant Series**



# Cirque Pendant Series

ALL DIMENSIONS IN MILLIMETRES

CIRQUE 5-3: Ø500 x 300H  
 CIRQUE 5-4: Ø500 x 400H

STANDARD SPECIFICATION

EXTERIOR MATERIAL: RAKUMBA RANGE  
 INTERIOR MATERIAL: WHITE STYRENE OR CLEAR PVC BACKING  
 DIFFUSER MATERIAL: WHITE PARCHMENT  
 DIFFUSER STYLE: FULL-FIT  
 LIGHT SOURCE: 1 x E27 // CFL OR LED GLOBES ARE RECOMMENDED MAX. 24W  
 SUSPENSION: SEAMLESS CANOPY // 1.5m CLEAR FLEX

CIRQUE 6-3: Ø600 x 300H  
 CIRQUE 6-4: Ø600 x 400H

STANDARD SPECIFICATION

EXTERIOR MATERIAL: RAKUMBA RANGE  
 INTERIOR MATERIAL: WHITE STYRENE OR CLEAR PVC BACKING  
 DIFFUSER MATERIAL: WHITE PARCHMENT  
 DIFFUSER STYLE: FULL-FIT  
 LIGHT SOURCE: 1 x E27 // CFL OR LED GLOBES ARE RECOMMENDED MAX. 24W  
 SUSPENSION: SEAMLESS CANOPY // 1.5m CLEAR FLEX

CIRQUE 7-1.5: Ø700 x 150H  
 CIRQUE 7-3: Ø700 x 300H  
 CIRQUE 7-4: Ø700 x 400H

STANDARD SPECIFICATION

EXTERIOR MATERIAL: RAKUMBA RANGE  
 INTERIOR MATERIAL: WHITE STYRENE OR CLEAR PVC BACKING  
 DIFFUSER MATERIAL: WHITE PARCHMENT  
 DIFFUSER STYLE: FULL-FIT  
 LIGHT SOURCE: 3 x E27 HUB // CFL OR LED GLOBES ARE RECOMMENDED MAX. 24W  
 SUSPENSION: SEAMLESS CANOPY // CLEAR FLEX 1.5m // 3 x STEEL CABLES TO CANOPY

CIRQUE 8-1.5: Ø800 x 150H  
 CIRQUE 8-3: Ø800 x 300H  
 CIRQUE 8-4: Ø800 x 400H

STANDARD SPECIFICATION

EXTERIOR MATERIAL: RAKUMBA RANGE  
 INTERIOR MATERIAL: WHITE STYRENE OR CLEAR PVC BACKING  
 DIFFUSER MATERIAL: WHITE PARCHMENT  
 DIFFUSER STYLE: FULL-FIT  
 LIGHT SOURCE: 3 x E27 HUB // CFL OR LED GLOBES ARE RECOMMENDED MAX. 24W  
 SUSPENSION: SEAMLESS CANOPY // CLEAR FLEX 1.5m // 3 x STEEL CABLES TO CANOPY

CIRQUE 9-1.5: Ø900 x 150H  
 CIRQUE 9-3: Ø900 x 300H  
 CIRQUE 9-4: Ø900 x 400H

STANDARD SPECIFICATION

EXTERIOR MATERIAL: RAKUMBA RANGE  
 INTERIOR MATERIAL: WHITE STYRENE OR CLEAR PVC BACKING  
 DIFFUSER MATERIAL: WHITE PARCHMENT  
 DIFFUSER STYLE: FULL-FIT  
 LIGHT SOURCE: 3 x E-27 HUB // CFL OR LED GLOBES ARE RECOMMENDED MAX. 24W  
 SUSPENSION: SEAMLESS CANOPY // CLEAR FLEX 1.5m // 4 x STEEL CABLES TO CANOPY

STANDARD PRODUCTS - ALL DIMENSIONS CAN BE CUSTOMISED

Cirque 5-3 Cirque 5-4

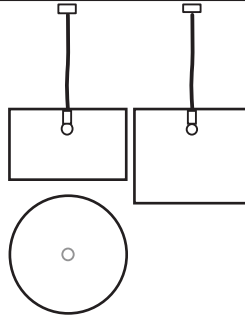

Cirque 6-3 Cirque 6-4

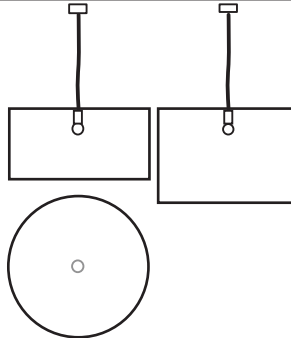

Cirque 7-1.5 Cirque 7-3 Cirque 7-4

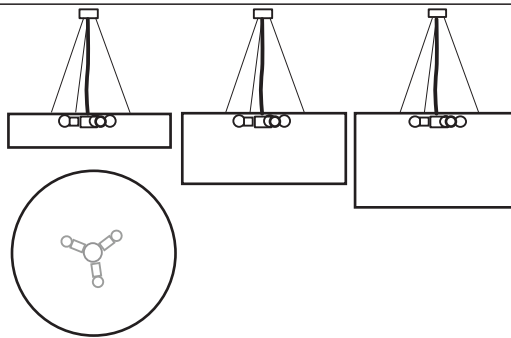

Cirque 8-1.5 Cirque 8-3 Cirque 8-4

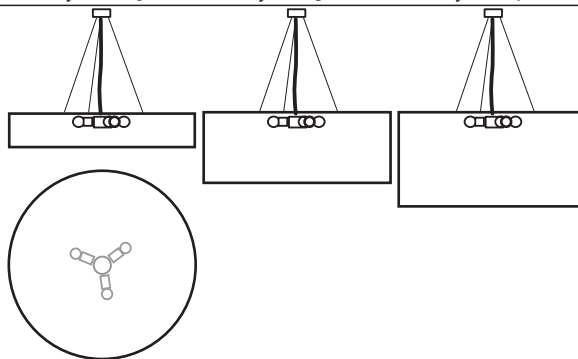

Cirque 9-1.5 Cirque 9-3 Cirque 9-4

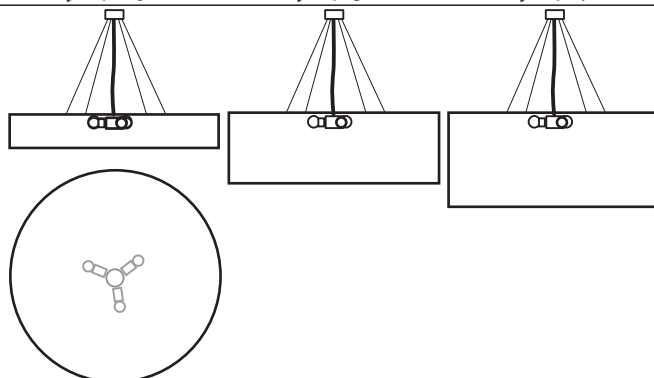

# Cirque Pendant Series

CIRQUE 10-1.5: Ø1000 x 150H  
 CIRQUE 10-3: Ø1000 x 300H  
 CIRQUE 10-4: Ø1000 x 400H

STANDARD SPECIFICATION

EXTERIOR MATERIAL: RAKUMBA RANGE  
 INTERIOR MATERIAL: WHITE STYRENE OR CLEAR PVC BACKING  
 DIFFUSER MATERIAL: WHITE PARCHMENT  
 DIFFUSER STYLE: FULL-FIT  
 LIGHT SOURCE: 3 x E27 HUB // CFL GLOBES ARE RECOMMENDED MAX. 24W  
 SUSPENSION: SEAMLESS CANOPY // CLEAR FLEX 1.5m // 4 x STEEL CABLES TO CANOPY

CIRQUE 11-1.5: Ø1100 x 150H  
 CIRQUE 11-4: Ø1100 x 400H

STANDARD SPECIFICATION

EXTERIOR MATERIAL: RAKUMBA RANGE  
 INTERIOR MATERIAL: WHITE STYRENE OR CLEAR PVC BACKING  
 DIFFUSER MATERIAL: WHITE PARCHMENT  
 DIFFUSER STYLE: FULL-FIT  
 LIGHT SOURCE: 4 x E27 HUB // CFL GLOBES ARE RECOMMENDED MAX. 24W  
 SUSPENSION: SEAMLESS CANOPY // CLEAR FLEX 1.5m // 4 x STEEL CABLES TO CANOPY

CIRQUE 12-1.5: Ø1200 x 150H  
 CIRQUE 12-4: Ø1200 x 400H

STANDARD SPECIFICATION

EXTERIOR MATERIAL: RAKUMBA RANGE  
 INTERIOR MATERIAL: WHITE STYRENE OR CLEAR PVC BACKING  
 DIFFUSER MATERIAL: WHITE PARCHMENT  
 DIFFUSER STYLE: FULL-FIT  
 LIGHT SOURCE: 4 x E27 HUB // CFL GLOBES ARE RECOMMENDED MAX. 24W  
 SUSPENSION: SEAMLESS CANOPY // CLEAR FLEX 1.5m // 4 x STEEL CABLES TO CANOPY

CIRQUE 15-1.5: Ø1500 x 150H  
 CIRQUE 15-4: Ø1500 x 400H

STANDARD SPECIFICATION

EXTERIOR MATERIAL: RAKUMBA RANGE  
 INTERIOR MATERIAL: WHITE STYRENE OR CLEAR PVC BACKING  
 DIFFUSER MATERIAL: WHITE PARCHMENT  
 DIFFUSER STYLE: FULL-FIT  
 LIGHT SOURCE: 4 x E27 EXTENDED HUB // CFL GLOBES ARE RECOMMENDED MAX. 24W  
 SUSPENSION: SEAMLESS CANOPY // CLEAR FLEX 1.5m // 4 x STEEL CABLES TO PUCKS

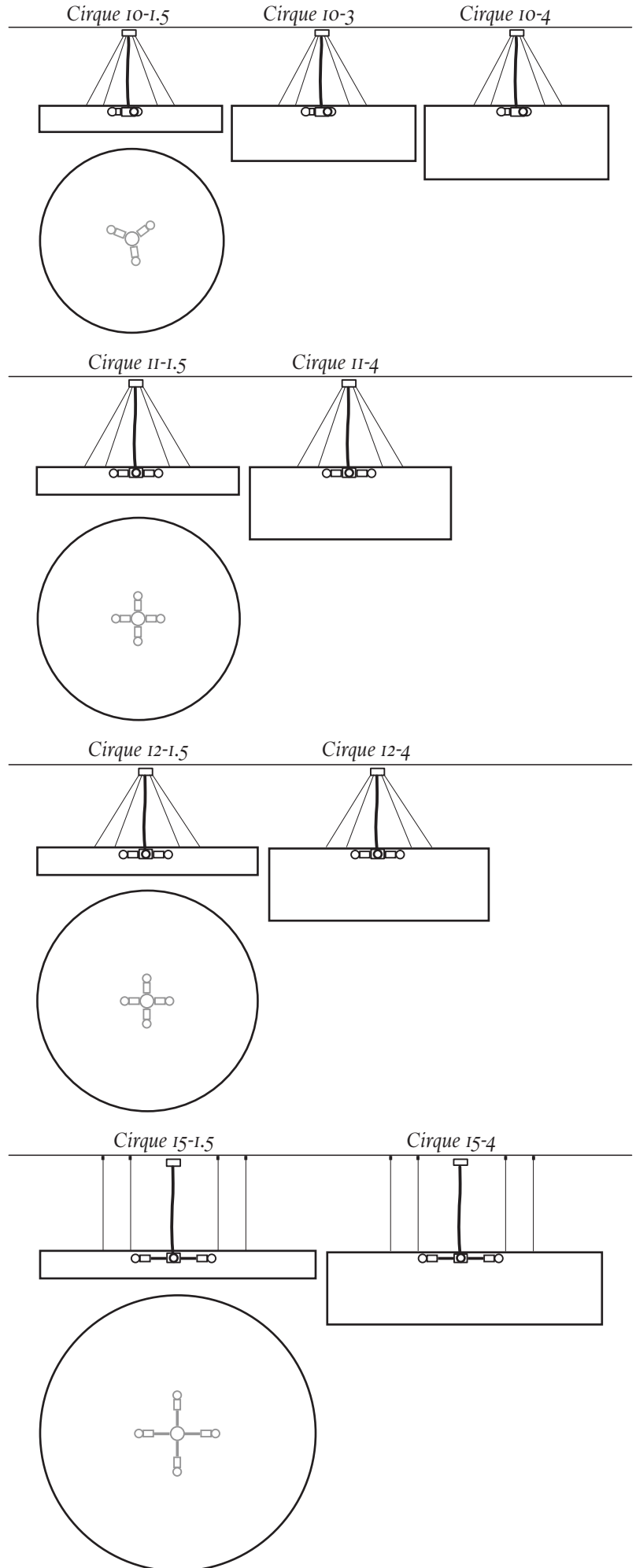

# Cirque Pendant Series

ALL PRODUCT DETAILS ARE HIGHLY CUSTOMISABLE ON REQUEST - THE ILLUSTRATIONS BELOW HIGHLIGHT JUST SOME OF THE AVAILABLE METHODS.

## CUSTOM INSPIRATION - MATERIALS\*

SELECT FROM AUSTRALIA'S MOST COMPREHENSIVE RANGE OF SHADE MATERIALS, SUPPLY YOUR OWN, OR DESIGN CUSTOM PRINTS AND CUT PATTERNS FOR A

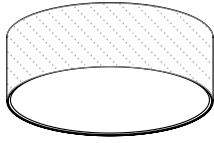

EXTERNAL MATERIAL

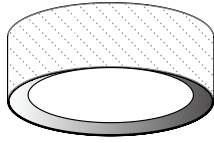

EXTERNAL & INTERNAL MATERIAL



CUSTOM DIGITAL PRINT

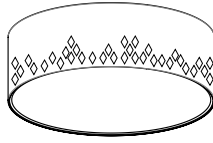

CUSTOM CNC CUT PATTERN  
(ALSO SEE RP-E-1306P 'MOTIF')

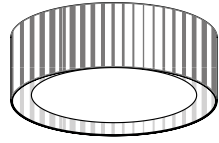

HAND PLEAT  
(VARIOUS STYLES AVAILABLE)

\*EDGE FINISH IS TAPED OR HAND-ROLLED (OPTIONAL)

## CUSTOM INSPIRATION - DIFFUSERS

DIFFUSERS ARE AVAILABLE IN A WIDE RANGE OF PARCHMENTS, BONDED FABRICS, AND ACRYLICS (PMMA) IN VARYING SURFACE TEXTURES AND LIGHT TRANSMISSION

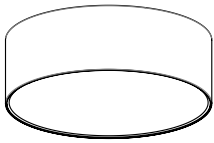

FULL FIT DIFFUSER

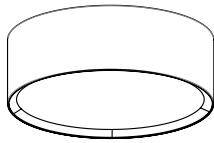

INSET DIFFUSER

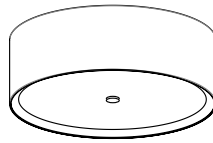

SUSPENDED DIFFUSER

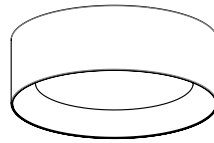

FLOATING DIFFUSER  
(ADJUSTABLE HEIGHT)

## CUSTOM INSPIRATION - SUSPENSIONS

CHOOSE FROM AN EXTENSIVE RANGE OF SUSPENSION TYPES, ALL WITH EMPHASIS ON HIGH QUALITY COMPONENTRY REFER TO OUR COMPONENT BROCHURES FOR DETAILS ON STANDARD FLEX, BRAIDED FLEX, PRINTED DECORATIVE FLEX, AND OUR PROPRIETARY SEAMLESS CANOPY

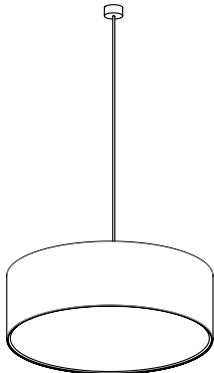

FLEX

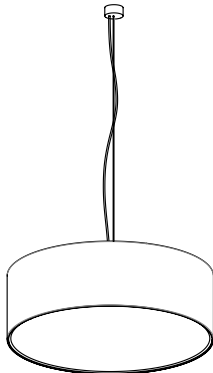

SINGLE CABLE / OFFSET FLEX

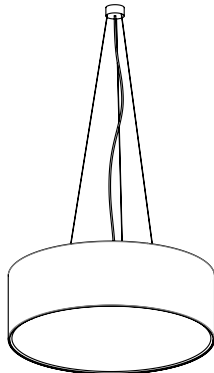

CABLES TO CANOPY

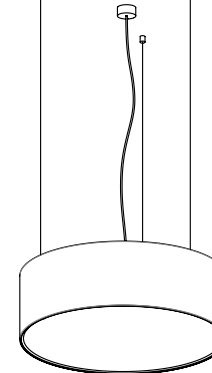

CABLES TO CEILING PUCKS

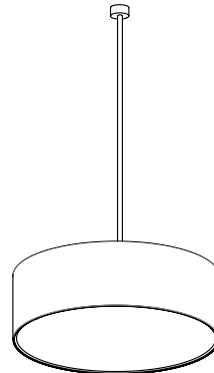

ROD SUSPENSION  
(OPTIONAL SWIVEL FOR RAKED CEILINGS)

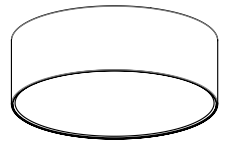

SURFACE MOUNT

## CUSTOM INSPIRATION - LIGHT SOURCES

OPTIMISE THE LIGHTING EFFECT FOR YOUR LUMINAIRE WITH ONE OF OUR STANDARD LIGHT SOURCES, OR CONTACT US TO DISCUSS BESPOKE ALTERNATIVES

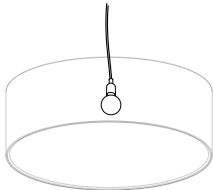

SINGLE E27

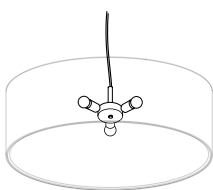

HUB (3 x E27 OR 4 x E27)

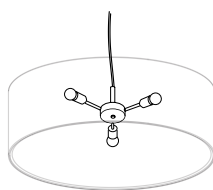

HUB (3 x E27 OR 4 x E27)  
WITH CUSTOM LENGTH  
EXTENSION ARMS

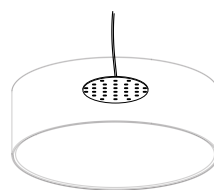

INTEGRATED LED

Rakumba has been producing custom-made feature lighting for the Australian design industry since 1968. Collaborating with designers across a wide range of sectors from commercial to residential, we take pride in our bespoke service, attention to design detailing and ability to deliver on any scale of project.



RP-E-1404P

**Cirque Taper Pendant Series**



# Cirque Taper Pendant Series

ALL DIMENSIONS IN MILLIMETRES

CIRQUE TAPER 3: Ø200T x Ø300B x 400H  
 CIRQUE TAPER 4: Ø300T x Ø400B x 500H  
 CIRQUE TAPER 6: Ø500T x Ø600B x 400H

STANDARD SPECIFICATION

EXTERIOR MATERIAL: RAKUMBA RANGE  
 INTERIOR MATERIAL: WHITE STYRENE OR CLEAR PVC BACKING  
 DIFFUSER MATERIAL: WHITE PARCHMENT  
 DIFFUSER STYLE: FLOATING  
 LIGHT SOURCE: 1 x E27 // CFL OR LED GLOBES ARE RECOMMENDED MAX. 24W  
 SUSPENSION: SEAMLESS CANOPY // 1.5m CLEAR FLEX

CIRQUE TAPER 8: Ø700T x Ø800B x 300H  
 CIRQUE TAPER 10: Ø900T x Ø1000B x 400H

STANDARD SPECIFICATION

EXTERIOR MATERIAL: RAKUMBA RANGE  
 INTERIOR MATERIAL: WHITE STYRENE OR CLEAR PVC BACKING  
 DIFFUSER MATERIAL: WHITE PARCHMENT  
 DIFFUSER STYLE: FLOATING  
 LIGHT SOURCE: 3 x E27 HUB // CFL OR LED GLOBES ARE RECOMMENDED MAX. 24W  
 SUSPENSION: SEAMLESS CANOPY // CLEAR FLEX 1.5m // 3 x STEEL CABLES TO CANOPY

STANDARD PRODUCTS - ALL DIMENSIONS CAN BE CUSTOMISED

Cirque Taper 3

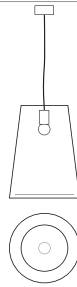

Cirque Taper 4

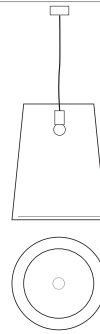

Cirque Taper 6

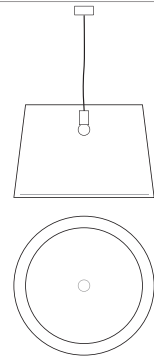

Cirque Taper 8

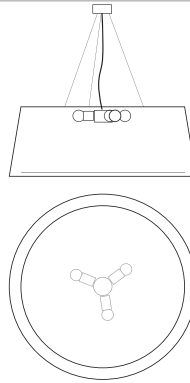

Cirque Taper 10

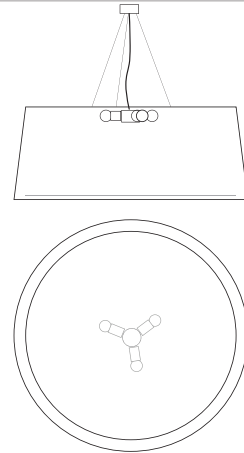

Custom Cirque Taper for Commonwealth Golf Club (MIM Design)

# Cirque Taper Pendant Series

ALL PRODUCT DETAILS ARE HIGHLY CUSTOMISABLE ON REQUEST - THE ILLUSTRATIONS BELOW HIGHLIGHT JUST SOME OF THE AVAILABLE METHODS.

## CUSTOM INSPIRATION - MATERIALS\*

SELECT FROM AUSTRALIA'S MOST COMPREHENSIVE RANGE OF SHADE MATERIALS, SUPPLY YOUR OWN, OR DESIGN CUSTOM PRINTS AND CUT PATTERNS FOR A UNIQUE FINISH

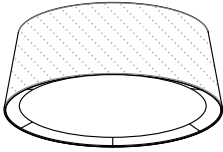

EXTERNAL MATERIAL

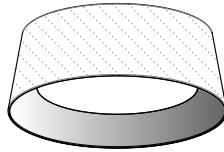

EXTERNAL & INTERNAL MATERIAL  
(RECOMMENDED WHEN DIFFUSER IS NOT FULL FIT)



CUSTOM DIGITAL PRINT

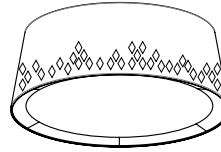

CUSTOM CNC CUT PATTERN  
(ALSO SEERP-E-1306P 'MOTIF')

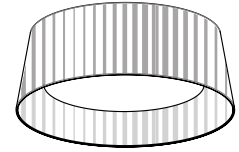

HAND PLEAT  
(VARIOUS STYLES AVAILABLE)

\*EDGE FINISH IS TAPED OR HAND-ROLLED (OPTIONAL)

## CUSTOM INSPIRATION - DIFFUSERS

DIFFUSERS ARE AVAILABLE IN A WIDE RANGE OF PARCHMENTS, BONDED FABRICS, AND ACRYLICS (PMMA) IN VARYING SURFACE TEXTURES AND LIGHT TRANSMISSION LEVELS

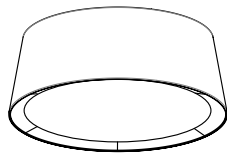

INSET DIFFUSER

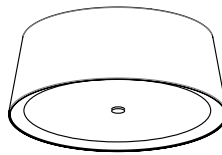

SUSPENDED DIFFUSER

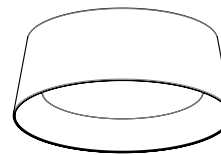

FLOATING DIFFUSER  
(ADJUSTABLE HEIGHT)

## CUSTOM INSPIRATION - SUSPENSIONS

CHOOSE FROM AN EXTENSIVE RANGE OF SUSPENSION TYPES, ALL WITH EMPHASIS ON HIGH QUALITY COMPONENTRY REFER TO OUR COMPONENT BROCHURES FOR DETAILS ON STANDARD FLEX, BRAIDED FLEX, PRINTED DECORATIVE FLEX, AND OUR PROPRIETARY SEAMLESS CANOPY

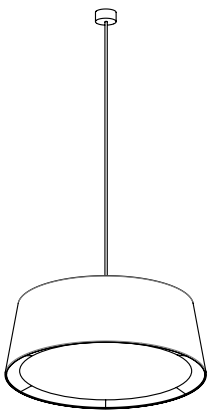

FLEX

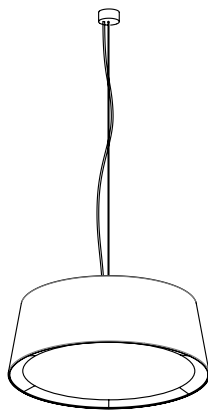

SINGLE CABLE / OFFSET FLEX

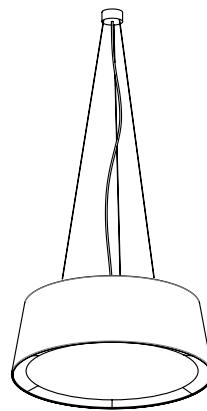

CABLES TO CANOPY

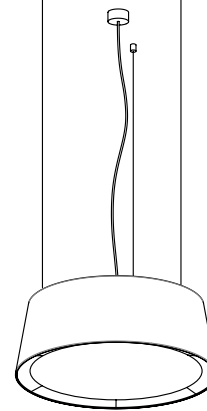

CABLES TO CEILING PUCKS

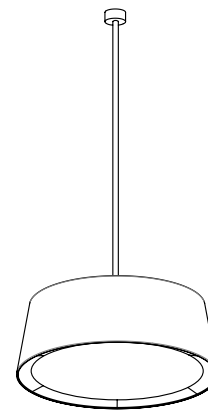

ROD SUSPENSION  
(OPTIONAL SWIVEL FOR RAKED CEILINGS)

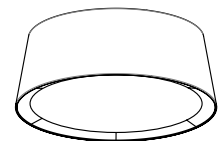

SURFACE MOUNT

## CUSTOM INSPIRATION - LIGHT SOURCES

OPTIMISE THE LIGHTING EFFECT FOR YOUR LUMINAIRE WITH ONE OF OUR STANDARD LIGHT SOURCES, OR CONTACT US TO DISCUSS BESPOKE ALTERNATIVES

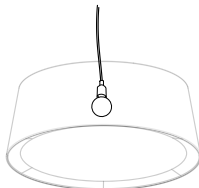

SINGLE E27

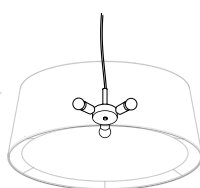

HUB (3 x E27 OR 4 x E27)

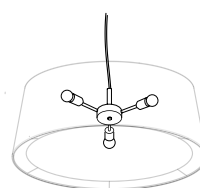

HUB (3 x E27 OR 4 x E27)  
WITH CUSTOM LENGTH  
EXTENSION ARMS

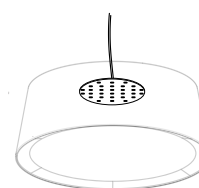

INTEGRATED LED

Rakumba has been producing custom-made feature lighting for the Australian design industry since 1968. Collaborating with designers across a wide range of sectors from commercial to residential, we take pride in our bespoke service, attention to design detailing and ability to deliver on any scale of project.

RP-E-1304P

**City Hall Pendant Series**



# City Hall Pendant Series

## TYPICAL APPLICATIONS



## DIMENSIONS

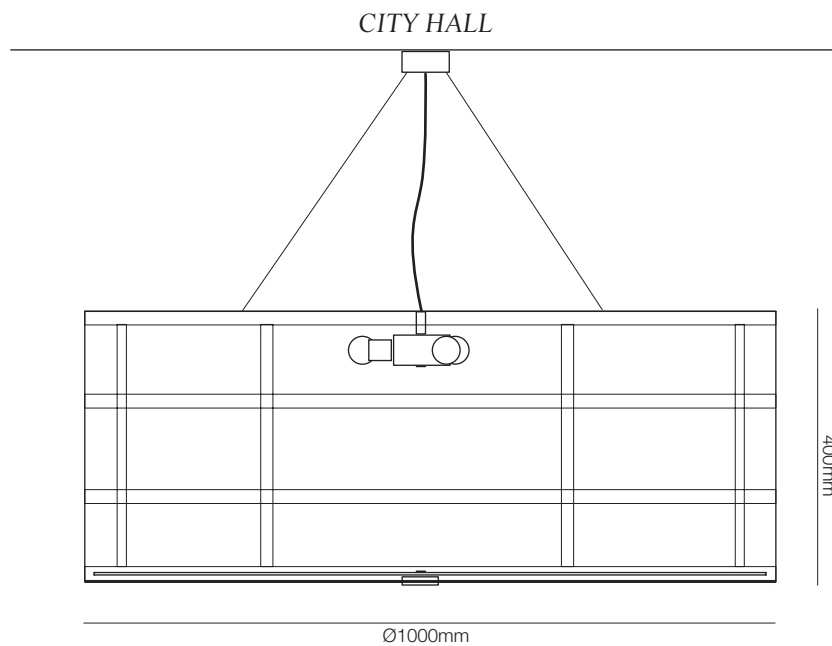

## PRODUCT TECHNICAL SPECIFICATION

NAME:	CITY HALL
STYLE:	PENDANT
MATERIALS & FINISH:	FRAME - POWDERCOATED STEEL (INTERPON SABLE SILVER OR INTERPON SABLE ASTEROID) SHADE - BONDED FABRIC (CHOOSE FROM RAKUMBA RANGE)
LIGHT SOURCE:	DIFFUSER - FULL FIT OPAL ACRYLIC (PMMA) WITH DECORATIVE CENTRE FLANGE STANDARD - 4 x E27 HUB // 240V // 24W MAX CFL OR LED RECOMMENDED OPTIONAL - TRIDONIC LED DISK // 29.2W // 3800lm // 3000K
DIMMING:	DIMMING OPTIONS FOR LED DISK - PHASE-CUT // DALI
SUSPENSION:	4 X STEEL CABLE // CLEAR PLASTIC FLEX // RAKUMBA SEAMLESS CANOPY

Rakumba has been producing custom-made feature lighting for the Australian design industry since 1968. Collaborating with designers across a wide range of sectors from commercial to residential, we take pride in our bespoke service, attention to design detailing and ability to deliver on any scale of project.

## Lampshades

From elegant hand-crafted classics to intriguing contemporary styles, Rakumba is capable of bringing any of your lampshade designs from concept to reality. Drawing from our extensive range of materials or your own custom supply, we can produce shades that range from simple to elaborate in single units or for commercial projects.





# Specification - Ordering Detail

STANDARD LAMPSHADE ORDER CHECKLIST - PLEASE CONTACT RAKUMBA FOR ANY CUSTOM SHADES OR SPECIAL REQUIREMENTS

## 1. SELECT STYLE AND SPECIFY DIMENSIONS

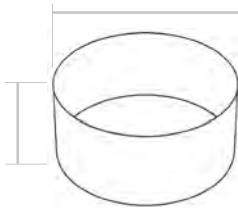
PLEASE NOTE THE UNITS USED (MILLIMETERS, CENTIMETERS OR INCHES)

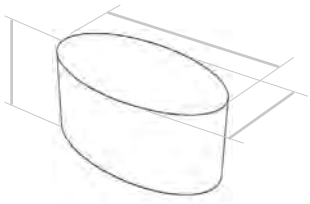
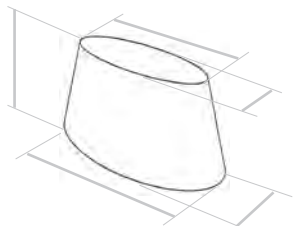
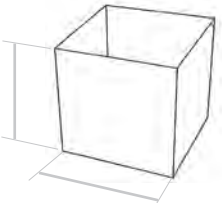
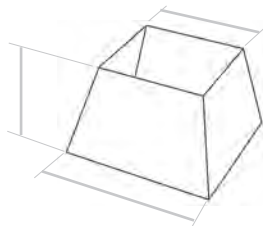
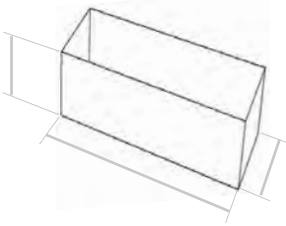
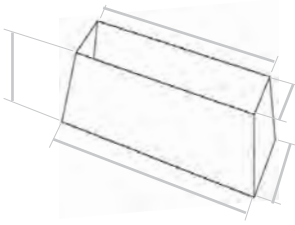
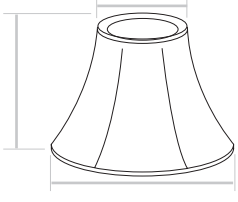
<p>ROUND DRUM</p>		<p>TAPERED ROUND</p>	
<p>OVAL</p>		<p>TAPERED OVAL</p>	
<p>SQUARE DRUM</p>		<p>TAPERED SQUARE</p>	
<p>RECTANGLE</p>		<p>TAPERED RECTANGLE</p>	
<p>SOFT/WAISTED PLEASE CONTACT RAKUMBA TO SPECIFY</p>		<p>CUSTOM PLEASE CONTACT RAKUMBA TO SPECIFY</p>	

ES LAMPHOLDER WASHER SET 2" UP FROM BOTTOM OF SHADE AS STANDARD  
BC LAMPHOLDER ADAPTOR SUPPLIED ON REQUEST

## 2. FABRIC / WALLPAPER

<p>RAKUMBA RANGE</p>	
<p>CUSTOMER SUPPLIED</p>	

## ADDITIONAL NOTES

---



---



---



---



---

## 3. EDGE FINISH

<p>ROLLED EDGE</p>	
<p>TAPED EDGE</p>	
<p>CUSTOM</p>	

At Rakumba, we stand for beauty, detail and going beyond the ordinary. This belief is at the core of why we do what we do. Rakumba has been producing custom-made feature lighting for the Australian design industry since 1968. Collaborating with designers across a wide range of sectors from commercial to residential, we take pride in our bespoke service, onsite prototyping skills and ability to deliver on any scale of project. Telephone +61 3 9579 2355

RP-E-1307P

## Geometry-8 Pendant





# Geometry-8 Pendant

## ORDERING OPTION 1 - SIZE

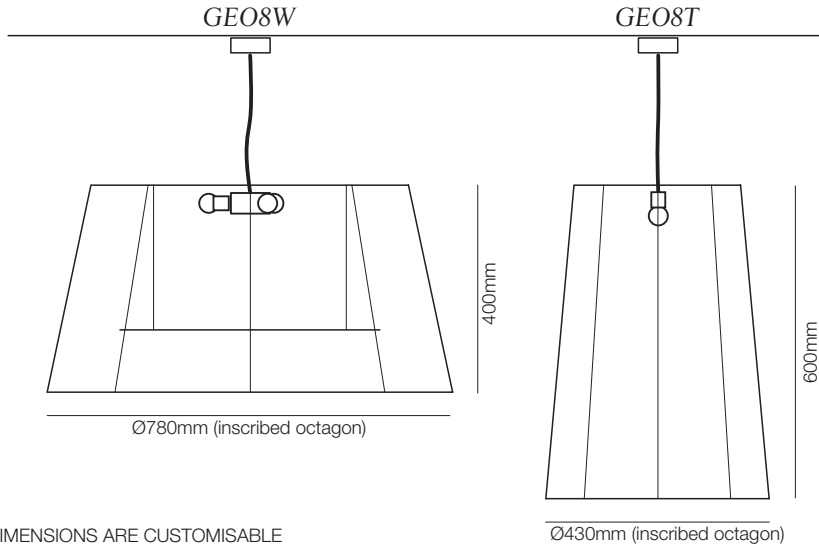

NUMBER OF SIDES AND ALL DIMENSIONS ARE CUSTOMISABLE

Ø430mm (inscribed octagon)

## ORDERING OPTION 2 - SHADE FABRIC (CUSTOM FABRIC ALSO AVAILABLE ON REQUEST)

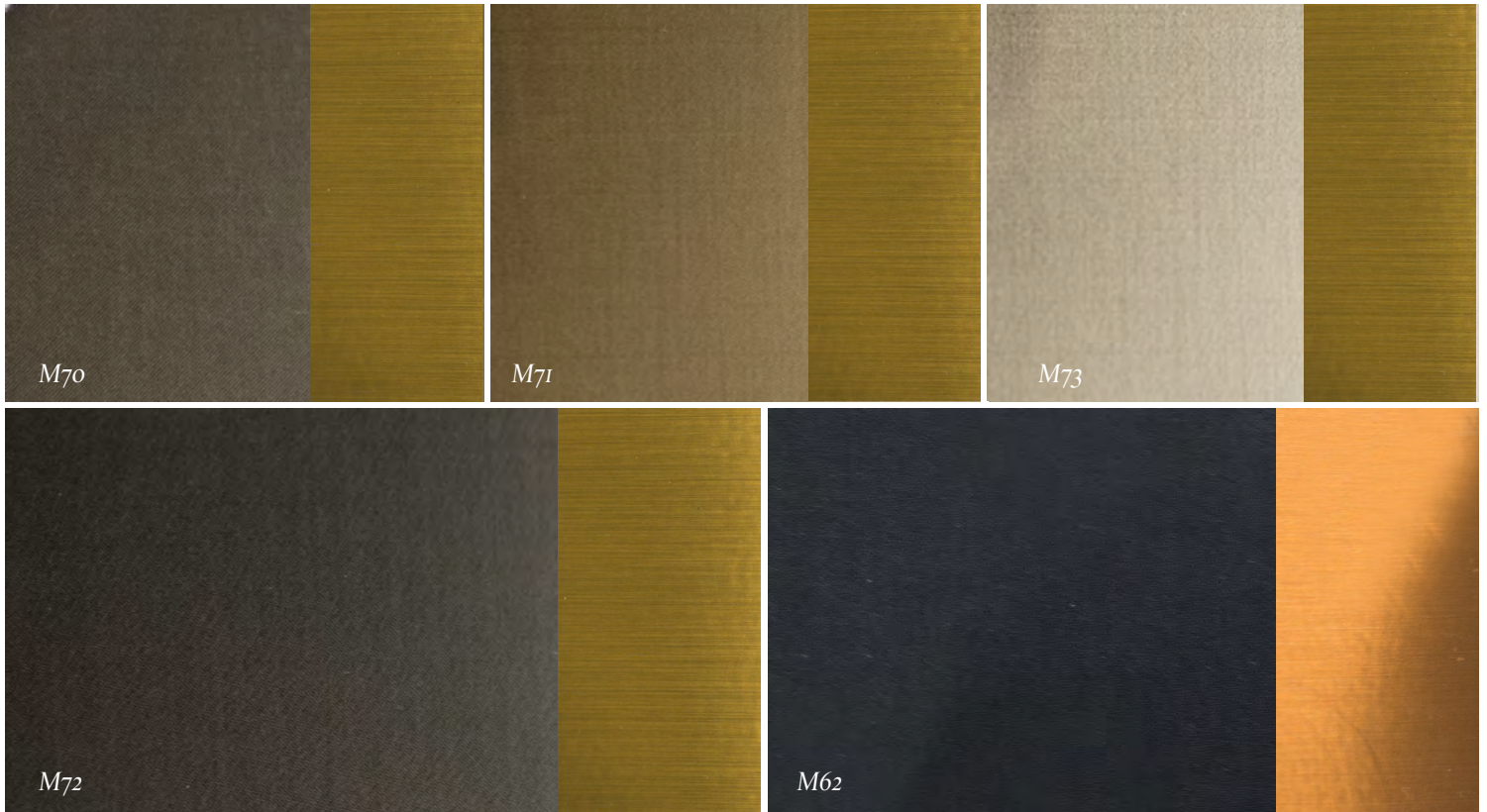

### PRODUCT TECHNICAL SPECIFICATION

NAME:	GEOMETRY-8	
STYLE:	PENDANT	
MATERIALS & FINISH:	FRAME -	POWDERCOATED STEEL
	SHADE -	INTERNAL AND EXTERNAL BONDED FABRIC
	DIFFUSER (GEO8W) -	WITH MATCHING BONDED FABRIC
LIGHT SOURCES:	GEO8W // 3 X E27 HUB // 240v // CFL GLOBES RECOMMENDED 24W MAX.	
	GEO8T // 1 X E27 // 240v // CFL GLOBE RECOMMENDED 24W MAX.	
SUSPENSION:	CLEAR FLEX	

Rakumba has been producing custom-made feature lighting for the Australian design industry since 1968. Collaborating with designers across a wide range of sectors from commercial to residential, we take pride in our bespoke service, attention to design detailing and ability to deliver on any scale of project.

RP-E-1302P

## Introvert & Extrovert Pendant Series



# Introvert & Extrovert Pendant Series

## ORDERING OPTION 1 - STYLE AND SIZE

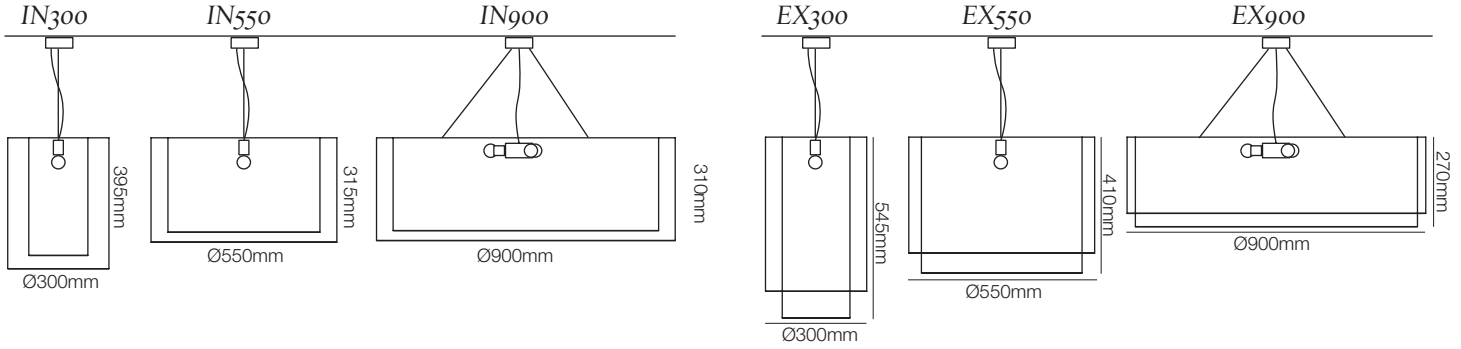

## ORDERING OPTION 2 - FABRIC COMBINATION NOTE: SHADES INCLUDE EDGE TRIM (NOT PICTURED) - (T): TAPED EDGE, (R): ROLLED EDGE, (L): TRIMLESS

### CLASSIC CHOICES FOR 'INTROVERT'

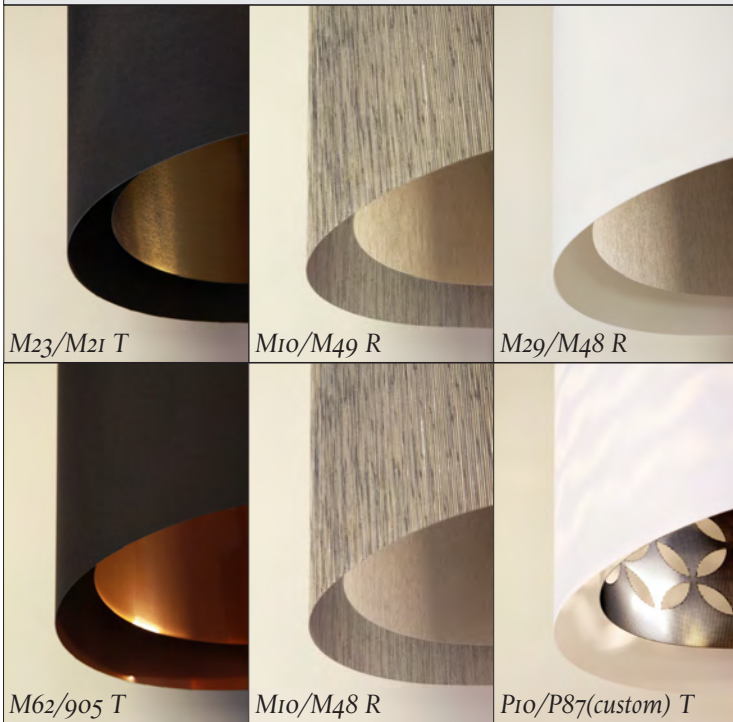

### CONTEMPORARY CHOICES FOR 'INTROVERT'

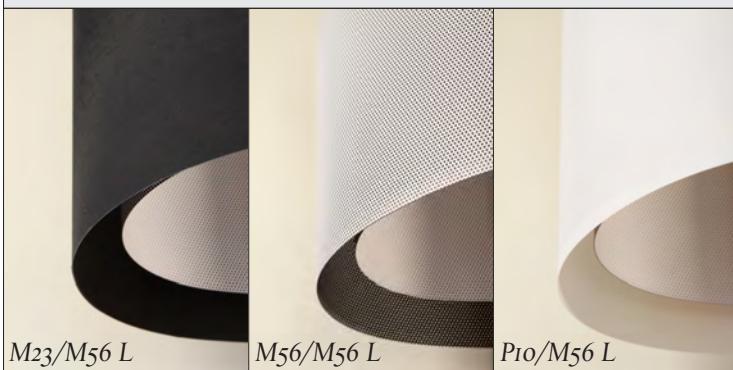

### CLASSIC CHOICES FOR 'EXTROVERT'



### CONTEMPORARY CHOICES FOR 'EXTROVERT'

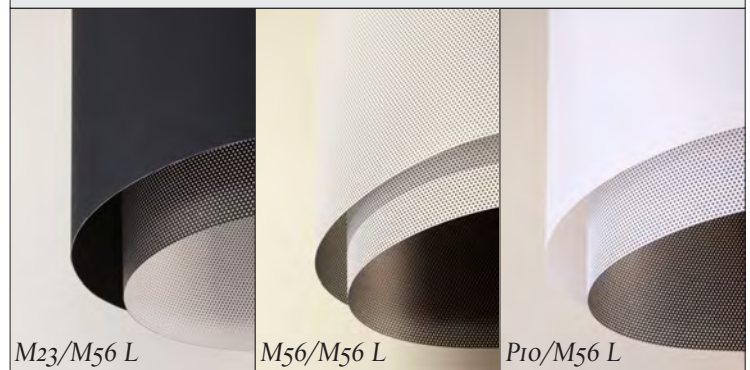

### PRODUCT TECHNICAL SPECIFICATION

NAME: INTROVERT & EXTROVERT  
 STYLE: PENDANT  
 MATERIALS & FINISH: POWDER COATED STEEL, STAINLESS STEEL, ALUMINIUM, PVC, PS, FABRIC

LIGHT SOURCE: 300 & 550 SIZES // 1 x E27 // 240V // MAX. 60W GLOBE  
 900 SIZE // 3 x E27 HUB // MAX. 60W GLOBES  
 OPTIONAL - TRIDONIC LED DISK // 29.2W // 3800LM // 3000K  
 SUSPENSION: 300 & 550 SIZES // 1 x STAINLESS STEEL CABLE // BRAIDED TEXTILE FLEX  
 900 SIZE // 3 x STEEL CABLES // BRAIDED TEXTILE FLEX

Rakumba has been producing custom-made feature lighting for the Australian design industry since 1968. Collaborating with designers across a wide range of sectors from commercial to residential, we take pride in our bespoke service, attention to design detailing and ability to deliver on any scale of project.

RP-E-1303P

**Iris Pendant Series**



# Iris Pendant Series

## ORDERING OPTION 1 - SIZE

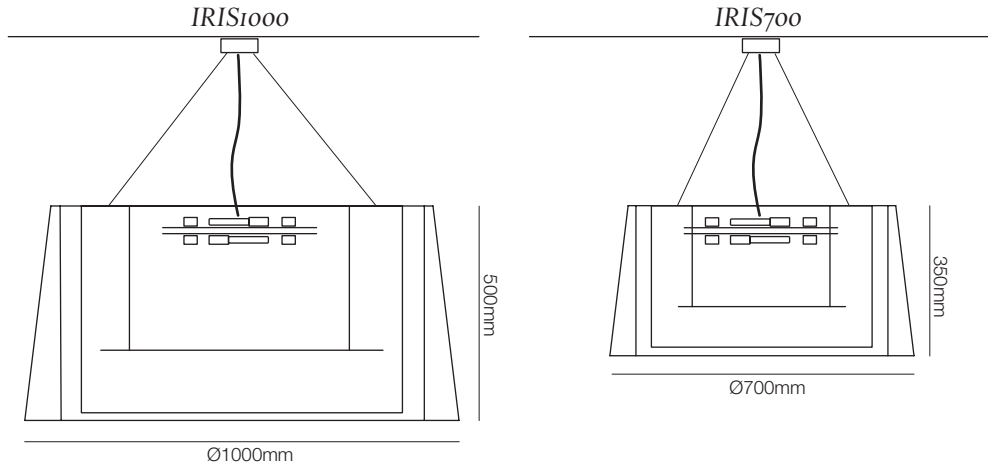

## ORDERING OPTION 2 - INNER SHADE FABRIC



### PRODUCT TECHNICAL SPECIFICATION

**NAME:** IRIS  
**STYLE:** PENDANT  
**MATERIALS & FINISH:** FRAME - POWDERCOATED STEEL  
 OUTER SHADE - BLACK FABRIC PLEATING  
 INNER SHADE - PVC / PS WITH BONDED FABRIC  
 DIFFUSER - WHITE FABRIC  
**LIGHT SOURCES:** STANDARD - STANDARD - 3 x E27 HUB // 240V // CFL/LED GLOBES RECOMMENDED 24W MAX.  
 OPTIONAL - 2 x TRIDONIC LED DISKS (UP + DOWN CONFIG) // 240V CONVERTER // 30W // 4090lm // 3000K // CRI 80 DIMMING  
 STANDARD - PHASE-CUT  
 OPTIONAL - 1-10V / DALI  
**SUSPENSION:** 4 x STAINLESS STEEL CABLE // BLACK DECORATIVE CLOTH FLEX

Rakumba has been producing custom-made feature lighting for the Australian design industry since 1968. Collaborating with designers across a wide range of sectors from commercial to residential, we take pride in our bespoke service, attention to design detailing and ability to deliver on any scale of project.

RP-E-1417W

**Kis Wall Series**



# Kis Wall Series

ORDERING OPTION 1 - WALL MOUNT CONFIGURATION (custom sizes and configurations also available)



ORDERING OPTION 2 - SHADE STYLE (custom styles and dimensions also available)



ORDERING OPTION 3 - BRACKET COLOUR (custom colours and finishes also available)

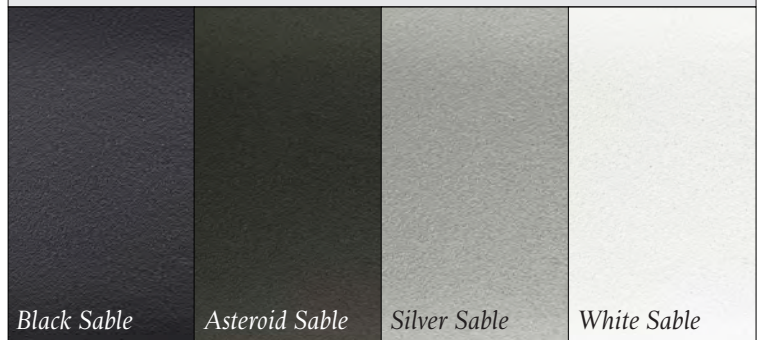

**PRODUCT TECHNICAL SPECIFICATION**

NAME: KIS  
 STYLE: WALL LIGHT  
 MATERIALS & FINISH: BRACKET - POWDERCOATED STEEL AND ALUMINIUM  
 SHADE - CUSTOMISABLE FABRIC (CONTACT RAKUMBA FOR EXTENSIVE RANGE OF OPTIONS)  
 LIGHT SOURCE: 1 X E27 // 240v // CFL GLOBES RECOMMENDED MAX. 24W

Rakumba has been producing custom-made feature lighting for the Australian design industry since 1968. Collaborating with designers across a wide range of sectors from commercial to residential, we take pride in our bespoke service, attention to design detailing and ability to deliver on any scale of project.

RP-E-1305P

**Loft Pendant Series**





# Loft Pendant Series

## ORDERING OPTION 1 - SIZE

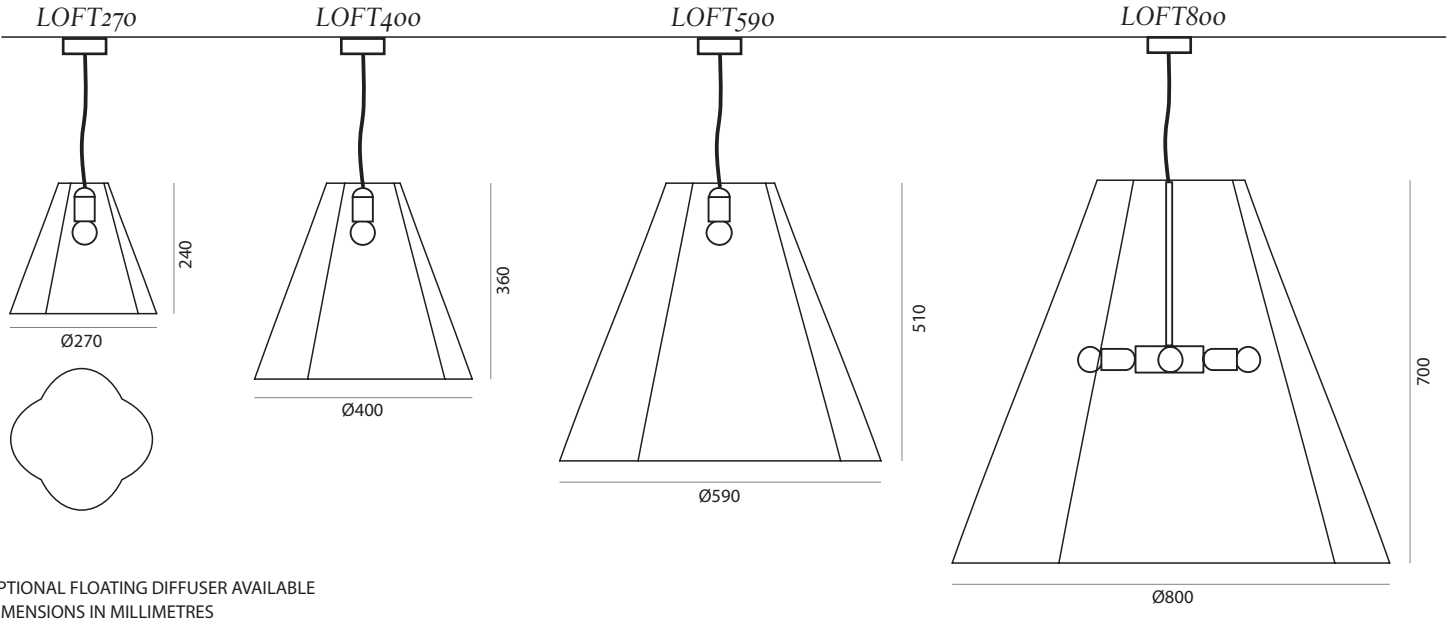

## ORDERING OPTION 3 - EXTERIOR FABRIC



## ORDERING OPTION 4 - INTERIOR FABRIC

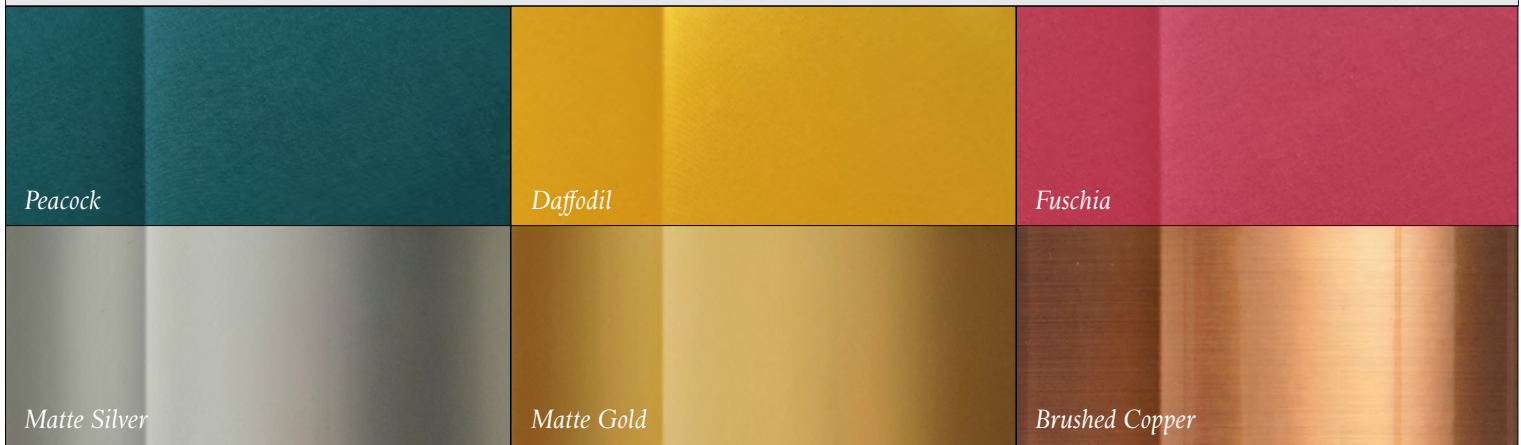

### PRODUCT TECHNICAL SPECIFICATION

NAME: LOFT  
 STYLE: PENDANT SERIES  
 MATERIALS & FINISH: FRAME - POWDERCOATED STEEL  
 SHADE - INTERNAL AND EXTERNAL BONDED FABRIC (CUSTOM OPTIONS AVAILABLE)  
 LIGHT SOURCE: LOFT270/400/590: 1 X E27 // 240v // CFL GLOBES RECOMMENDED 24W MAX.  
 LOFT800: 4 X E27 // 240v // CFL GLOBES RECOMMENDED 24W MAX.  
 SUSPENSION: 1.5m BRAIDED TEXTILE FLEX // SEAMLESS CANOPY

Rakumba has been producing custom-made feature lighting for the Australian design industry since 1968. Collaborating with designers across a wide range of sectors from commercial to residential, we take pride in our bespoke service, attention to design detailing and ability to deliver on any scale of project.

RP-E-1411P

## Metro Pendant



# Metro Pendant

## DIMENSIONS

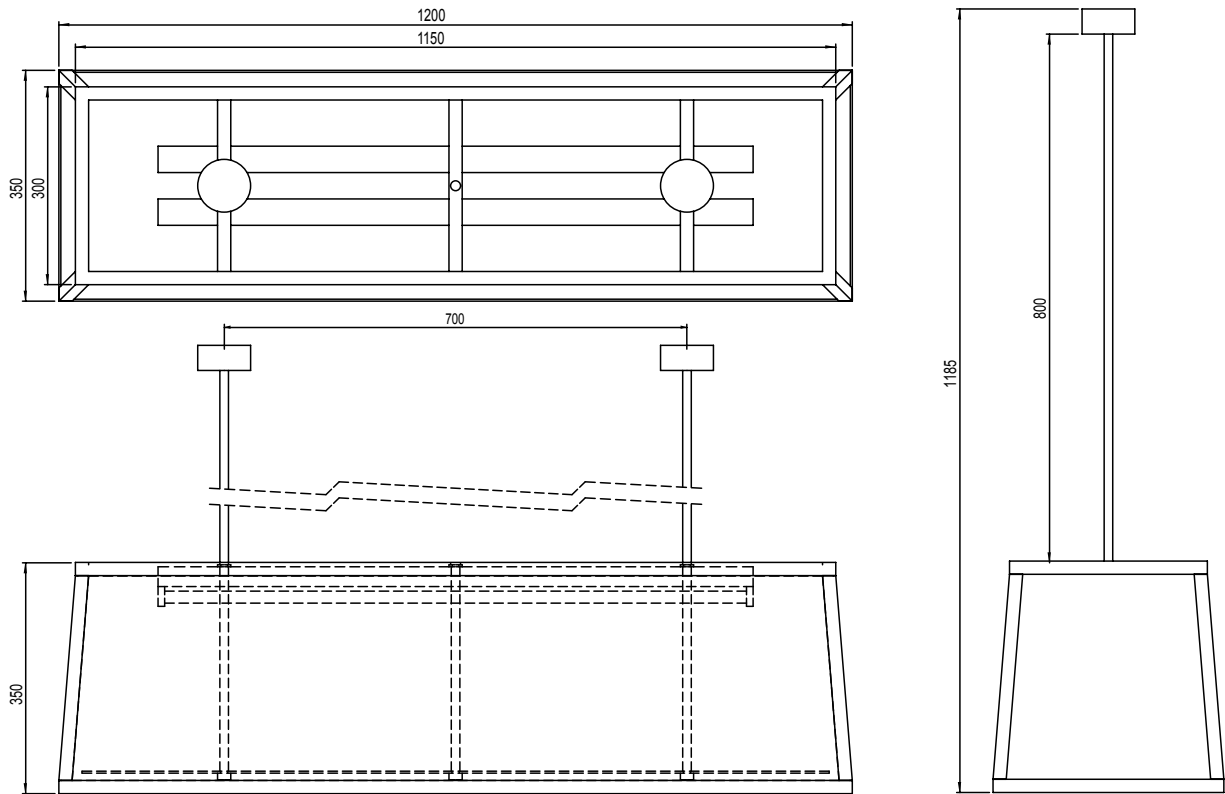

## PRODUCT TECHNICAL SPECIFICATION

NAME:	METRO
STYLE:	PENDANT
MATERIALS & FINISH:	FRAME - POWDERCOATED STEEL (INTERPON ASTEROID) SUSPENSION - POWDERCOATED ALUMINIUM (INTERPON ASTEROID) SHADE - BONDED FABRIC ON WHITE STYRENE BACKING (EXPRESSED FRAME EDGE DETAILING) DIFFUSER - GLOSS OPAL ACRYLIC (PMMA)
LIGHT SOURCE:	STANDARD - 4 x E27 BAR // 240v // CFL/LED GLOBES RECOMMENDED 24W MAX. OPTIONAL - TRIDONIC LED // 240V DRIVER // 35.2W // 4800lm // 3000K
DIMMING:	LED LIGHT SOURCE STANDARD - NON-DIMMABLE LED LIGHT SOURCE OPTIONS - SWITCH-DIM // DALI
SUSPENSION:	2 X 800mm RODS // 2 X SEAMLESS CANOPIES

Rakumba has been producing custom-made feature lighting for the Australian design industry since 1968. Collaborating with designers across a wide range of sectors from commercial to residential, we take pride in our bespoke service, attention to design detailing and ability to deliver on any scale of project.

RP-E-1403P

## Quad Pendant Series



# Quad Pendant Series

ALL DIMENSIONS IN MILLIMETRES

QUAD 5-3: 500 x 500 x 300H  
 QUAD 5-4: 500 x 500 x 400H

STANDARD SPECIFICATION

EXTERIOR MATERIAL: RAKUMBA RANGE  
 INTERIOR MATERIAL: WHITE STYRENE OR CLEAR PVC BACKING  
 DIFFUSER MATERIAL: WHITE PARCHMENT  
 DIFFUSER STYLE: FULL-FIT  
 LIGHT SOURCE: 1 x E27 // CFL GLOBES ARE RECOMMENDED MAX. 24W  
 SUSPENSION: SEAMLESS CANOPY // 1.5m CLEAR FLEX

QUAD 6-3: 600 x 600 x 300H  
 QUAD 6-4: 600 x 600 x 400H

STANDARD SPECIFICATION

EXTERIOR MATERIAL: RAKUMBA RANGE  
 INTERIOR MATERIAL: WHITE STYRENE OR CLEAR PVC BACKING  
 DIFFUSER MATERIAL: WHITE PARCHMENT  
 DIFFUSER STYLE: FULL-FIT  
 LIGHT SOURCE: 1 x E27 // CFL GLOBES ARE RECOMMENDED MAX. 24W  
 SUSPENSION: SEAMLESS CANOPY // 1.5m CLEAR FLEX

QUAD 7-1.5: 700 x 700 x 150H  
 QUAD 7-3: 700 x 700 x 300H  
 QUAD 7-4: 700 x 700 x 400H

STANDARD SPECIFICATION

EXTERIOR MATERIAL: RAKUMBA RANGE  
 INTERIOR MATERIAL: WHITE STYRENE OR CLEAR PVC BACKING  
 DIFFUSER MATERIAL: WHITE PARCHMENT  
 DIFFUSER STYLE: FULL-FIT  
 LIGHT SOURCE: 3 x E27 HUB // CFL GLOBES ARE RECOMMENDED MAX. 24W  
 SUSPENSION: SEAMLESS CANOPY // CLEAR FLEX 1.5m // 4 x STEEL CABLES TO CANOPY

QUAD 8-1.5: 800 x 800 x 150H  
 QUAD 8-3: 800 x 800 x 300H  
 QUAD 8-4: 800 x 800 x 400H

STANDARD SPECIFICATION

EXTERIOR MATERIAL: RAKUMBA RANGE  
 INTERIOR MATERIAL: WHITE STYRENE OR CLEAR PVC BACKING  
 DIFFUSER MATERIAL: WHITE PARCHMENT  
 DIFFUSER STYLE: FULL-FIT  
 LIGHT SOURCE: 3 x E27 HUB // CFL GLOBES ARE RECOMMENDED MAX. 24W  
 SUSPENSION: SEAMLESS CANOPY // CLEAR FLEX 1.5m // 4 x STEEL CABLES TO CANOPY

STANDARD PRODUCTS - ALL DIMENSIONS CAN BE CUSTOMISED

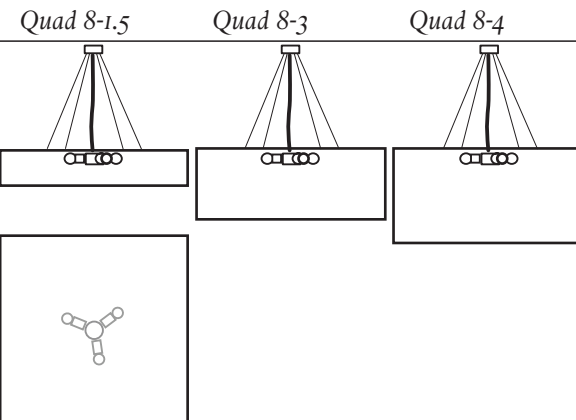
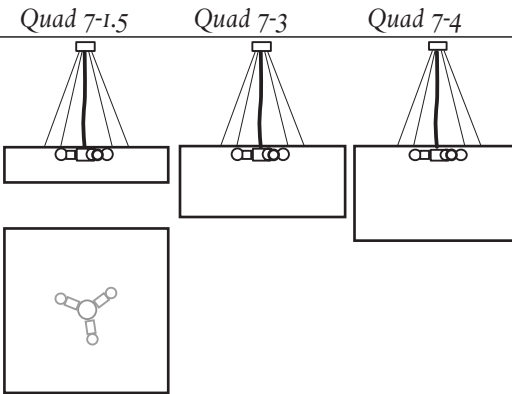
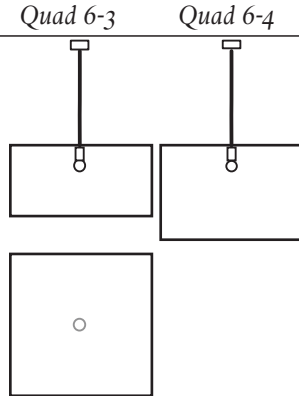
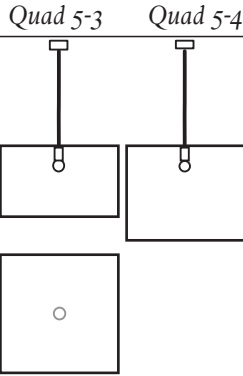

# Quad Pendant Series

QUAD 9-1.5: 900 x 900 x 150H  
 QUAD 9-3: 900 x 900 x 300H  
 QUAD 9-4: 900 x 900 x 400H

STANDARD SPECIFICATION

EXTERIOR MATERIAL: RAKUMBA RANGE  
 INTERIOR MATERIAL: WHITE STYRENE OR CLEAR PVC BACKING  
 DIFFUSER MATERIAL: WHITE PARCHMENT  
 DIFFUSER STYLE: FULL-FIT  
 LIGHT SOURCE: 3 x E-27 HUB // CFL GLOBES ARE RECOMMENDED MAX. 24W  
 SUSPENSION: SEAMLESS CANOPY // CLEAR FLEX 1.5m // 4 x STEEL CABLES TO CANOPY

QUAD 10-1.5: 1000 x 1000 x 150H  
 QUAD 10-3: 1000 x 1000 x 300H  
 QUAD 10-4: 1000 x 1000 x 400H

STANDARD SPECIFICATION

EXTERIOR MATERIAL: RAKUMBA RANGE  
 INTERIOR MATERIAL: WHITE STYRENE OR CLEAR PVC BACKING  
 DIFFUSER MATERIAL: WHITE PARCHMENT  
 DIFFUSER STYLE: FULL-FIT  
 LIGHT SOURCE: 3 x E27 HUB // CFL GLOBES ARE RECOMMENDED MAX. 24W  
 SUSPENSION: SEAMLESS CANOPY // CLEAR FLEX 1.5m // 4 x STEEL CABLES TO CANOPY

QUAD 11-1.5: 1100 x 1100 x 150H  
 QUAD 11-4: 1100 x 1100 x 400H

STANDARD SPECIFICATION

EXTERIOR MATERIAL: RAKUMBA RANGE  
 INTERIOR MATERIAL: WHITE STYRENE OR CLEAR PVC BACKING  
 DIFFUSER MATERIAL: WHITE PARCHMENT  
 DIFFUSER STYLE: FULL-FIT  
 LIGHT SOURCE: 4 x E27 HUB // CFL GLOBES ARE RECOMMENDED MAX. 24W  
 SUSPENSION: SEAMLESS CANOPY // CLEAR FLEX 1.5m // 4 x STEEL CABLES TO CANOPY

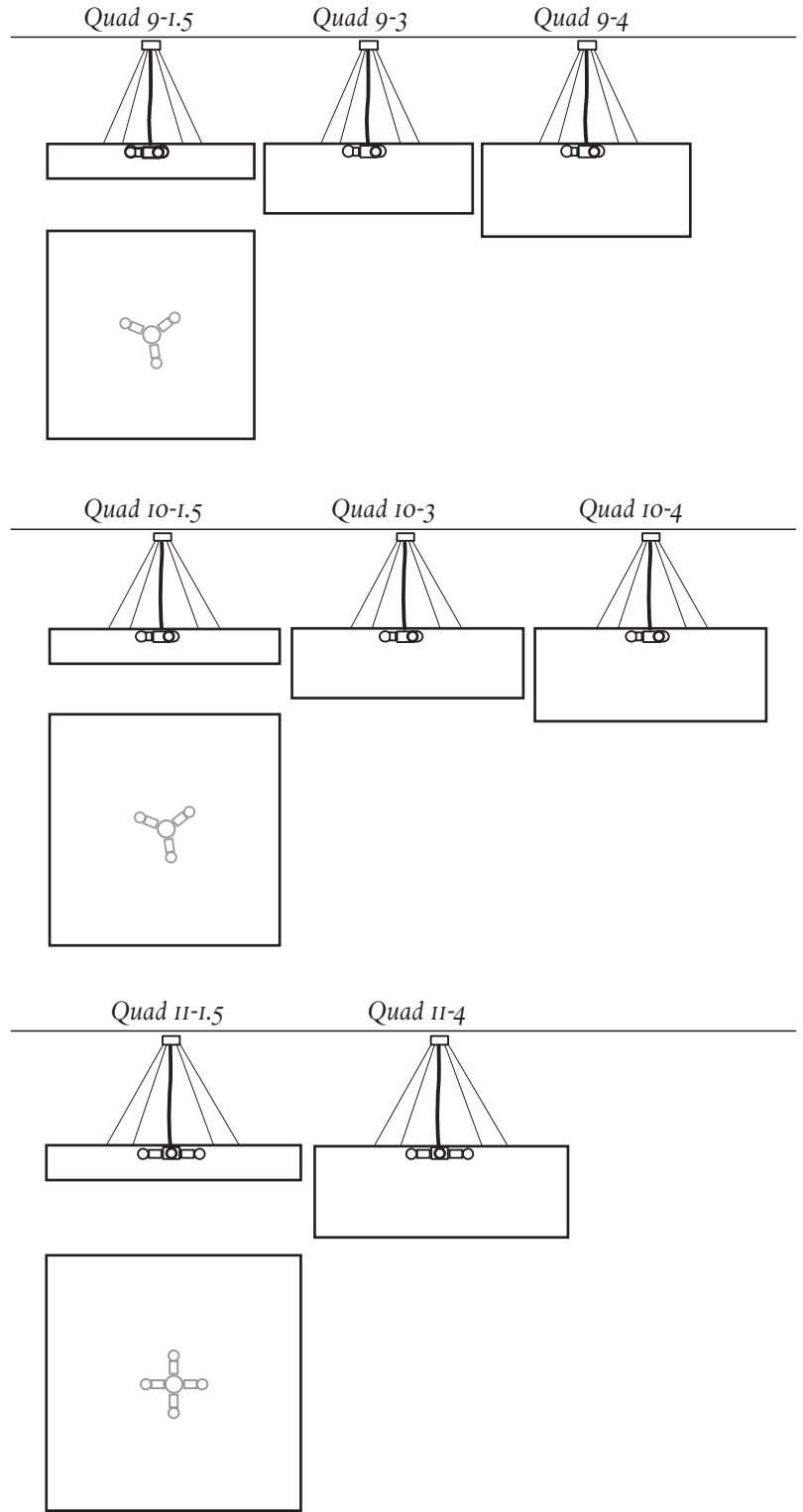

ALL PRODUCT DETAILS ARE HIGHLY CUSTOMISABLE ON REQUEST - THE ILLUSTRATIONS BELOW AND OVERLEAF HIGHLIGHT JUST SOME OF THE AVAILABLE METHODS.

CUSTOM INSPIRATION - CORNERS

CREATE A DISTINCTIVE LOOK WITH OUR ALTERNATIVE CORNER DETAILS

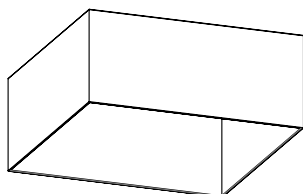

SQUARE

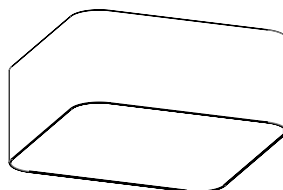

RADIUS

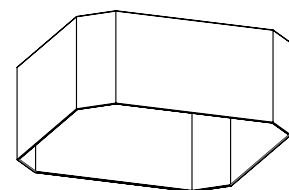

CHAMFER

# Quad Pendant Series

## CUSTOM INSPIRATION - MATERIALS\*

SELECT FROM AUSTRALIA'S MOST COMPREHENSIVE RANGE OF SHADE MATERIALS, SUPPLY YOUR OWN, OR DESIGN CUSTOM PRINTS AND CUT PATTERNS FOR A

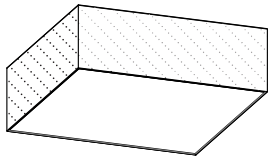

EXTERNAL MATERIAL

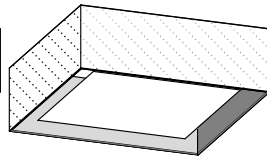

EXTERNAL & INTERNAL MATERIAL  
(RECOMMENDED WHEN

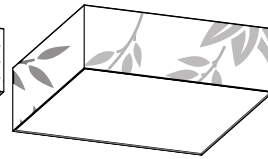

CUSTOM DIGITAL PRINT

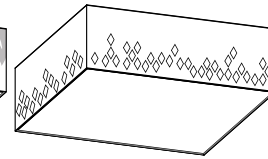

CUSTOM CNC CUT PATTERN  
(ALSO SEE RP-E-1306P  
'MOTIF')

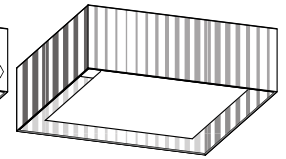

HAND PLEAT  
(VARIOUS STYLES AVAILABLE)

\*EDGE FINISH IS TAPED OR HAND-ROLLED (OPTIONAL)

## CUSTOM INSPIRATION - DIFFUSERS

DIFFUSERS ARE AVAILABLE IN A WIDE RANGE OF PARCHMENTS, BONDED FABRICS, AND ACRYLICS (PMMA) IN VARYING SURFACE TEXTURES AND LIGHT TRANSMISSION

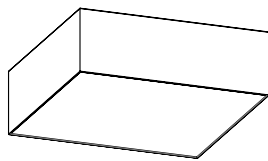

FULL FIT DIFFUSER

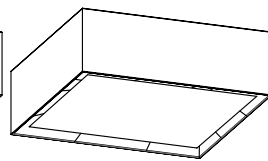

INSET DIFFUSER

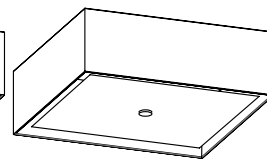

SUSPENDED DIFFUSER

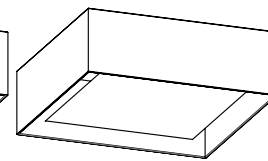

FLOATING DIFFUSER  
(ADJUSTABLE HEIGHT)

## CUSTOM INSPIRATION - SUSPENSIONS

CHOOSE FROM AN EXTENSIVE RANGE OF SUSPENSION TYPES, ALL WITH EMPHASIS ON HIGH QUALITY COMPONENTRY REFER TO OUR COMPONENT BROCHURES FOR DETAILS ON STANDARD FLEX, BRAIDED FLEX, PRINTED DECORATIVE FLEX, AND OUR PROPRIETARY SEAMLESS CANOPY

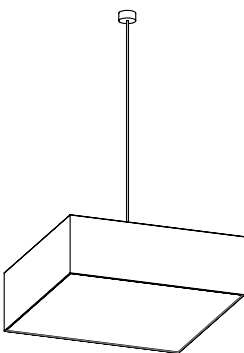

FLEX

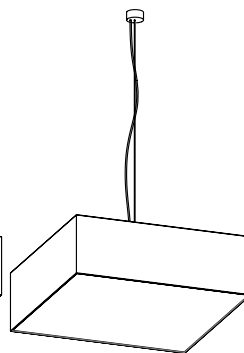

SINGLE CABLE / OFFSET  
FLEX

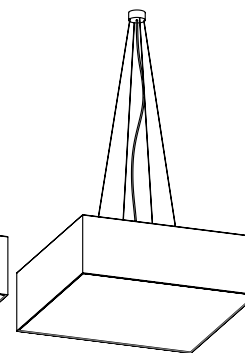

CABLES TO CANOPY

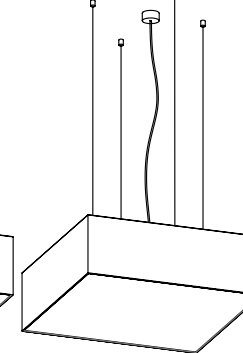

CABLES TO CEILING PUCKS

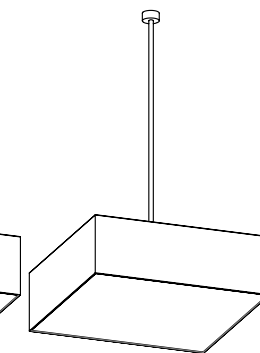

ROD SUSPENSION  
(OPTIONAL SWIVEL  
FOR RAKED CEILINGS)

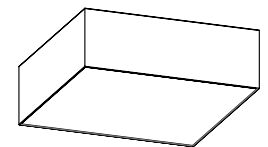

SURFACE MOUNT

## CUSTOM INSPIRATION - LIGHT SOURCES

OPTIMISE THE LIGHTING EFFECT FOR YOUR LUMINAIRE WITH ONE OF OUR STANDARD LIGHT SOURCES, OR CONTACT US TO DISCUSS BESPOKE ALTERNATIVES

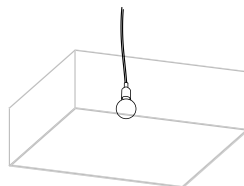

SINGLE E27

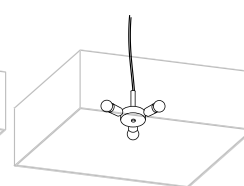

HUB (3 x E27 OR 4 x E27)

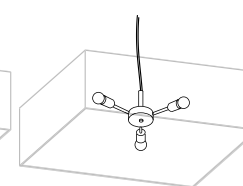

HUB (3 x E27 OR 4 x E27)  
WITH CUSTOM LENGTH  
EXTENSION ARMS

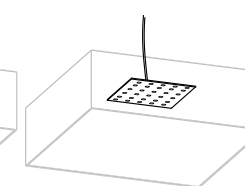

INTEGRATED LED

Rakumba has been producing custom-made feature lighting for the Australian design industry since 1968. Collaborating with designers across a wide range of sectors from commercial to residential, we take pride in our bespoke service, attention to design detailing and ability to deliver on any scale of project.

RP-E-1406P

## Quad Taper Pendant Series





# Quad Taper Pendant Series

ALL DIMENSIONS IN MILLIMETRES

QUAD TAPER 3: 200<sup>2</sup>T x 300<sup>2</sup>B x 400H  
 QUAD TAPER 4: 300<sup>2</sup>T x 400<sup>2</sup>B x 500H  
 QUAD TAPER 6: 500<sup>2</sup>T x 600<sup>2</sup>B x 400H

STANDARD SPECIFICATION

EXTERIOR MATERIAL: RAKUMBA RANGE  
 INTERIOR MATERIAL: WHITE STYRENE OR CLEAR PVCBACKING  
 DIFFUSER MATERIAL: WHITE PARCHMENT  
 DIFFUSER STYLE: FLOATING  
 LIGHT SOURCE: 1 x E27 // CFL GLOBES ARE RECOMMENDED MAX. 24W  
 SUSPENSION: SEAMLESS CANOPY // 1.5m CLEAR FLEX

QUAD TAPER 8: 700<sup>2</sup>T x 800<sup>2</sup>Bx 300H  
 QUAD TAPER 10: 900<sup>2</sup>T x 1000<sup>2</sup>B x 400H

STANDARD SPECIFICATION

EXTERIOR MATERIAL: RAKUMBA RANGE  
 INTERIOR MATERIAL: WHITESTYRENE OR CLEAR PVCBACKING  
 DIFFUSER MATERIAL: WHITE PARCHMENT  
 DIFFUSER STYLE: FLOATING  
 LIGHT SOURCE: 3 x E27 HUB // CFL GLOBES ARE RECOMMENDED MAX. 24W  
 SUSPENSION: SEAMLESS CANOPY // CLEAR FLEX 1.5m // 4 x STEEL CABLES TO CANOPY

STANDARD PRODUCTS - ALL DIMENSIONS CAN BE CUSTOMISED

Quad Taper 3

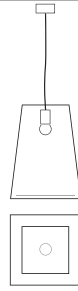

Quad Taper 4



Quad Taper 6

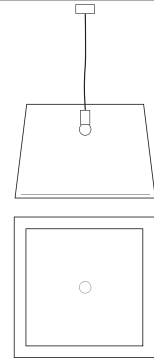

Quad Taper 8

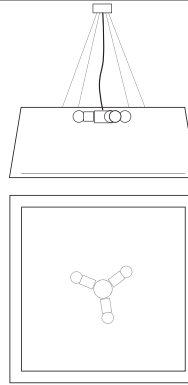

Quad Taper 10

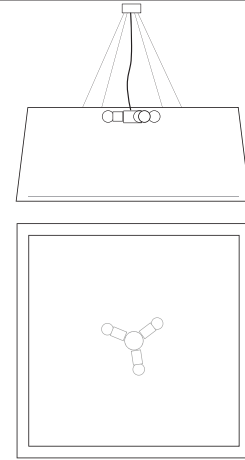

ALL PRODUCT DETAILS ARE HIGHLY CUSTOMISABLE ON REQUEST - THE ILLUSTRATIONS BELOW AND OVERLEAF HIGHLIGHT JUST SOME OF THE AVAILABLE METHODS.

CUSTOM INSPIRATION - CORNERS

CREATE A DISTINCTIVE LOOK WITH OUR ALTERNATIVE CORNER DETAILS

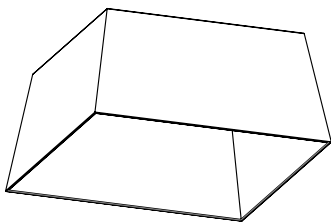

SQUARE

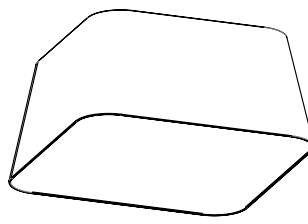

RADIUS

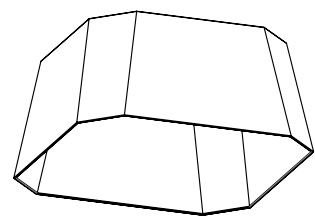

CHAMFER

CUSTOM INSPIRATION - MATERIALS\*

SELECT FROM AUSTRALIA'S MOST COMPREHENSIVE RANGE OF SHADE MATERIALS, SUPPLY YOUR OWN, OR DESIGN CUSTOM PRINTS AND CUT PATTERNS FOR A UNIQUE FINISH

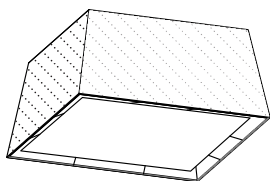

EXTERNAL MATERIAL

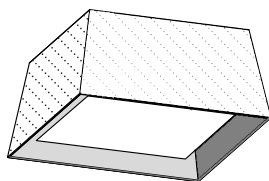

EXTERNAL & INTERNAL MATERIAL (RECOMMENDED WHEN DIFFUSER IS NOT FULL FIT)

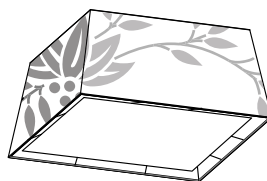

CUSTOM DIGITAL PRINT

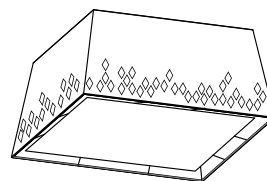

CUSTOM CNC CUT PATTERN (ALSO SEE RP-E-1306P 'MOTIF')

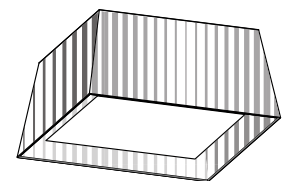

HAND PLEAT (VARIOUS STYLES AVAILABLE)

\*EDGE FINISH IS TAPED OR HAND-ROLLED (OPTIONAL)

# Quad Taper Pendant Series

## CUSTOM INSPIRATION - DIFFUSERS

DIFFUSERS ARE AVAILABLE IN A WIDE RANGE OF PARCHMENTS, BONDED FABRICS, AND ACRYLICS (PMMA) IN VARYING SURFACE TEXTURES AND LIGHT TRANSMISSION LEVELS

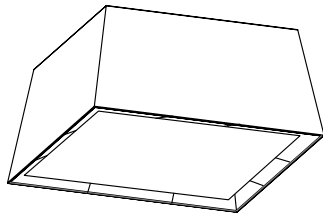

INSET DIFFUSER

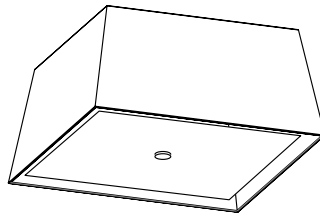

SUSPENDED DIFFUSER

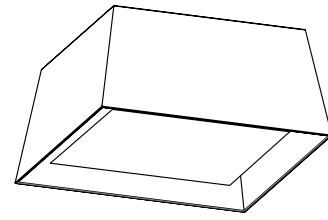

FLOATING DIFFUSER  
(ADJUSTABLE HEIGHT)

## CUSTOM INSPIRATION - SUSPENSIONS

CHOOSE FROM AN EXTENSIVE RANGE OF SUSPENSION TYPES, ALL WITH EMPHASIS ON HIGH QUALITY COMPONENTRY  
REFER TO OUR COMPONENT BROCHURES FOR DETAILS ON STANDARD FLEX, BRAIDED FLEX, PRINTED DECORATIVE FLEX, AND OUR PROPRIETARY SEAMLESS CANOPY

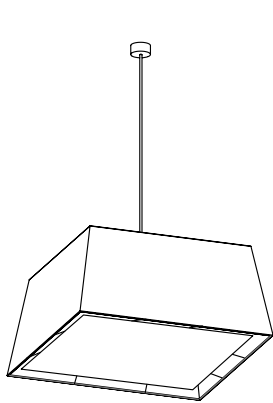

FLEX

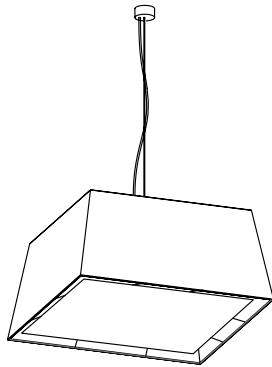

SINGLE CABLE / OFFSET FLEX

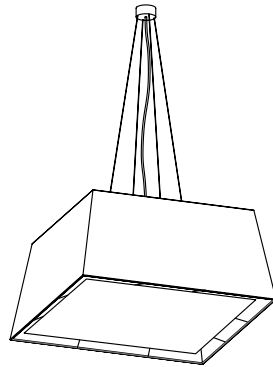

CABLES TO CANOPY

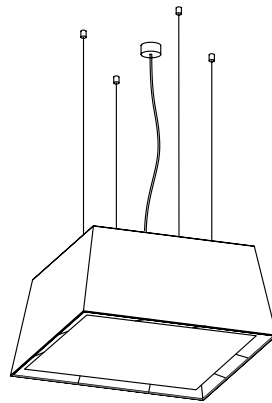

CABLES TO CEILING PUCKS

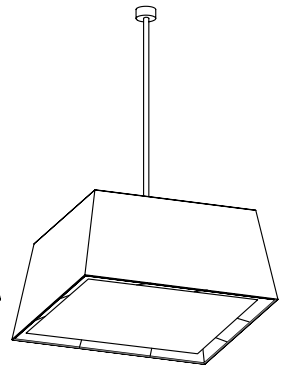

ROD SUSPENSION  
(OPTIONAL SWIVEL  
FOR RAKED CEILINGS)

## CUSTOM INSPIRATION - LIGHT SOURCES

OPTIMISE THE LIGHTING EFFECT FOR YOUR LUMINAIRE WITH ONE OF OUR STANDARD LIGHT SOURCES, OR CONTACT US TO DISCUSS BESPOKE ALTERNATIVES

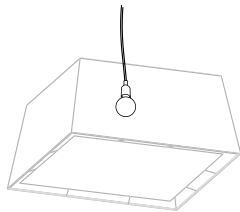

SINGLE E27

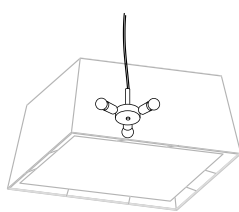

HUB (3 x E27 OR 4 x E27)

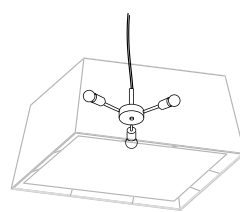

HUB (3 x E27 OR 4 x E27)  
WITH CUSTOM LENGTH  
EXTENSION ARMS

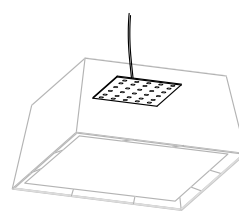

INTEGRATED LED

Rakumba has been producing custom-made feature lighting for the Australian design industry since 1968. Collaborating with designers across a wide range of sectors from commercial to residential, we take pride in our bespoke service, attention to design detailing and ability to deliver on any scale of project.

RP-E-1405P

## Ratio Pendant Series



# Ratio Pendant Series

ALL DIMENSIONS IN MILLIMETRES

RATIO 8-2: 800 x 200 x 250H  
 RATIO 8-3: 800 x 300 x 300H

STANDARD SPECIFICATION  
 EXTERIOR MATERIAL: RAKUMBA RANGE  
 INTERIOR MATERIAL: WHITE STYRENE OR CLEAR PVC BACKING  
 DIFFUSER MATERIAL: WHITE PARCHMENT  
 DIFFUSER STYLE: FULL-FIT  
 LIGHT SOURCE: 2 x E27 BAR // CFL GLOBES ARE RECOMMENDED MAX. 24W  
 SUSPENSION: SEAMLESS CANOPY // 2 x STAINLESS STEEL CABLES TO PUCKS // 1.5m CLEAR FLEX

RATIO 9-2: 900 x 200 x 250H  
 RATIO 9-3: 900 x 300 x 300H

STANDARD SPECIFICATION  
 EXTERIOR MATERIAL: RAKUMBA RANGE  
 INTERIOR MATERIAL: WHITE STYRENE OR CLEAR PVC BACKING  
 DIFFUSER MATERIAL: WHITE PARCHMENT  
 DIFFUSER STYLE: FULL-FIT  
 LIGHT SOURCE: 3 x E27 BAR // CFL GLOBES ARE RECOMMENDED MAX. 24W  
 SUSPENSION: SEAMLESS CANOPY // 2 x STAINLESS STEEL CABLES TO PUCKS // 1.5m CLEAR FLEX

RATIO 10-2: 1000 x 200 x 250H  
 RATIO 10-3: 1000 x 300 x 300H

STANDARD SPECIFICATION  
 EXTERIOR MATERIAL: RAKUMBA RANGE  
 INTERIOR MATERIAL: WHITE STYRENE OR CLEAR PVC BACKING  
 DIFFUSER MATERIAL: WHITE PARCHMENT  
 DIFFUSER STYLE: FULL-FIT  
 LIGHT SOURCE: 3 x E27 BAR // CFL GLOBES ARE RECOMMENDED MAX. 24W  
 SUSPENSION: SEAMLESS CANOPY // 2 x STAINLESS STEEL CABLES TO PUCKS // 1.5m CLEAR FLEX

RATIO 11-2: 1100 x 200 x 250H  
 RATIO 11-3: 1100 x 300 x 300H

STANDARD SPECIFICATION  
 EXTERIOR MATERIAL: RAKUMBA RANGE  
 INTERIOR MATERIAL: WHITE STYRENE OR CLEAR PVC BACKING  
 DIFFUSER MATERIAL: WHITE PARCHMENT  
 DIFFUSER STYLE: FULL-FIT  
 LIGHT SOURCE: 3 x E27 BAR // CFL GLOBES ARE RECOMMENDED MAX. 24W  
 SUSPENSION: SEAMLESS CANOPY // 2 x STAINLESS STEEL CABLES TO PUCKS // 1.5m CLEAR FLEX

RATIO 12-2: 1200 x 200 x 250H  
 RATIO 12-3: 1200 x 300 x 300H

STANDARD SPECIFICATION  
 EXTERIOR MATERIAL: RAKUMBA RANGE  
 INTERIOR MATERIAL: WHITE STYRENE OR CLEAR PVC BACKING  
 DIFFUSER MATERIAL: WHITE PARCHMENT  
 DIFFUSER STYLE: FULL-FIT  
 LIGHT SOURCE: 4 x E27 BAR // CFL GLOBES ARE RECOMMENDED MAX. 24W  
 SUSPENSION: SEAMLESS CANOPY // 2 x STAINLESS STEEL CABLES TO PUCKS // 1.5m CLEAR FLEX

RATIO 15-2: 1500 x 200 x 250H  
 RATIO 15-3: 1500 x 300 x 300H

STANDARD SPECIFICATION  
 EXTERIOR MATERIAL: RAKUMBA RANGE  
 INTERIOR MATERIAL: WHITE STYRENE OR CLEAR PVC BACKING  
 DIFFUSER MATERIAL: WHITE PARCHMENT  
 DIFFUSER STYLE: FULL-FIT  
 LIGHT SOURCE: 4 x E27 BAR // CFL GLOBES ARE RECOMMENDED MAX. 24W  
 SUSPENSION: SEAMLESS CANOPY // 2 x STAINLESS STEEL CABLES TO PUCKS // 1.5m CLEAR FLEX

STANDARD PRODUCTS - ALL DIMENSIONS CAN BE CUSTOMISED

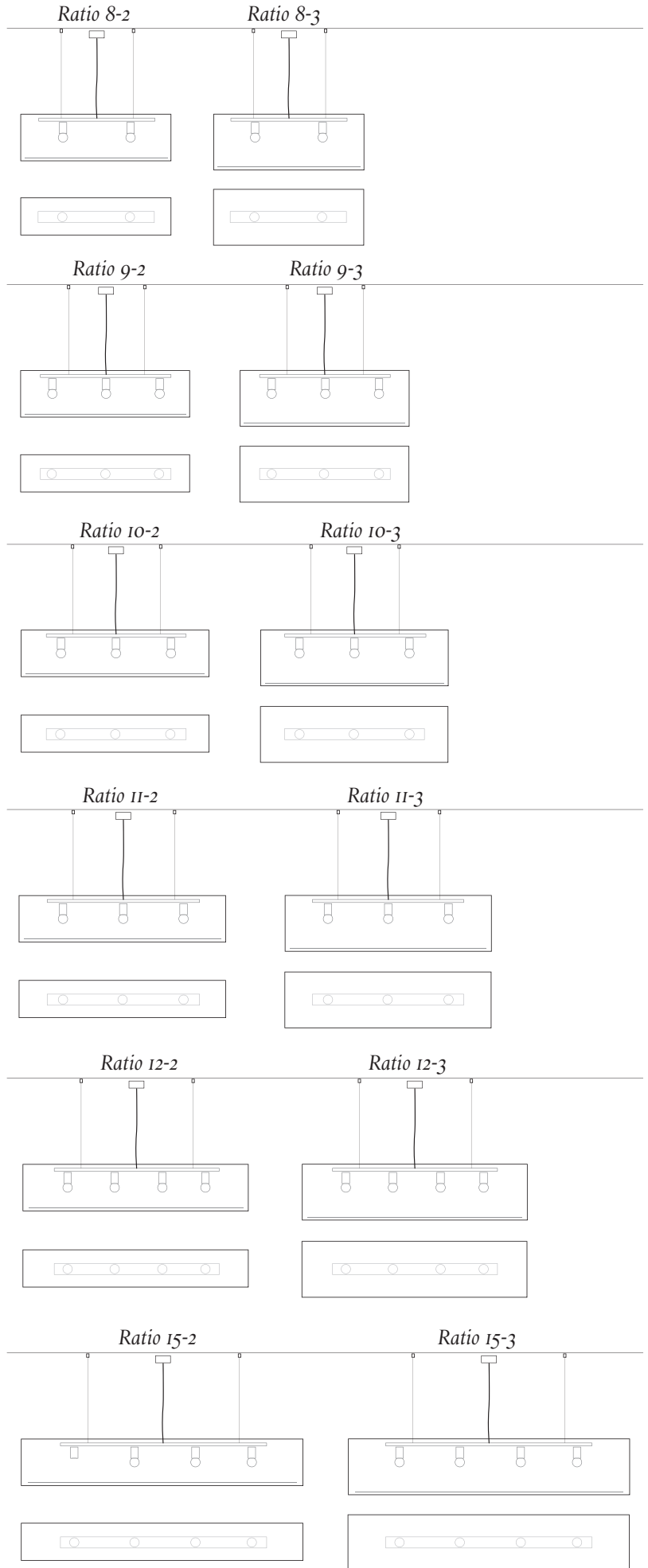

# Ratio Pendant Series



*Custom Ratio for Hospitality Project, Sydney (JSB)*

ALL PRODUCT DETAILS ARE HIGHLY CUSTOMISABLE ON REQUEST - THE ILLUSTRATIONS BELOW AND OVERLEAF HIGHLIGHT JUST SOME OF THE AVAILABLE METHODS.

## CUSTOM INSPIRATION - CORNERS

CREATE A DISTINCTIVE LOOK WITH OUR ALTERNATIVE CORNER DETAILS

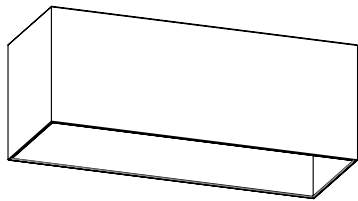

SQUARE

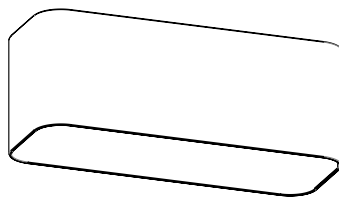

RADIUS

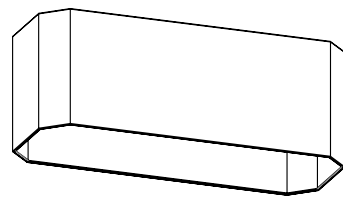

CHAMFER

## CUSTOM INSPIRATION - MATERIALS\*

SELECT FROM AUSTRALIA'S MOST COMPREHENSIVE RANGE OF SHADE MATERIALS, SUPPLY YOUR OWN, OR DESIGN CUSTOM PRINTS AND CUT PATTERNS FOR A UNIQUE FINISH

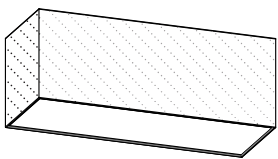

EXTERNAL MATERIAL

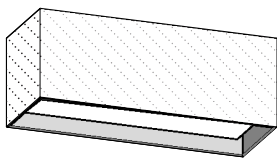

EXTERNAL & INTERNAL MATERIAL  
(RECOMMENDED WHEN DIFFUSER IS NOT FULL FIT)

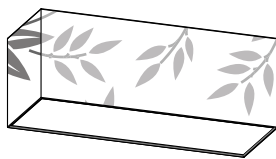

CUSTOM DIGITAL PRINT

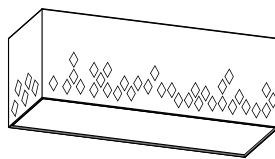

CUSTOM CNC CUT PATTERN  
(ALSO SEE RP-E-1306P 'MOTIF')

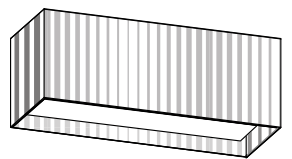

HAND PLEAT  
(VARIOUS STYLES AVAILABLE)

\*EDGE FINISH IS TAPED OR HAND-ROLLED (OPTIONAL)

# Ratio Pendant Series

## CUSTOM INSPIRATION - DIFFUSERS

DIFFUSERS ARE AVAILABLE IN A WIDE RANGE OF PARCHMENTS, BONDED FABRICS, AND ACRYLICS (PMMA) IN VARYING SURFACE TEXTURES AND LIGHT TRANSMISSION LEVELS

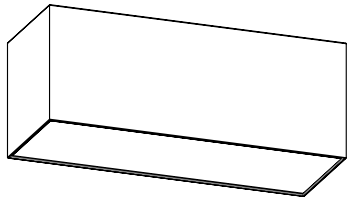

FULL FIT DIFFUSER

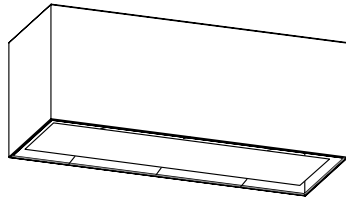

INSET DIFFUSER

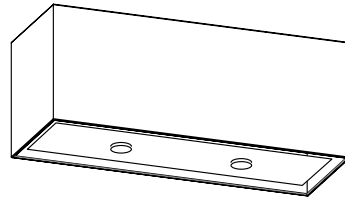

SUSPENDED DIFFUSER

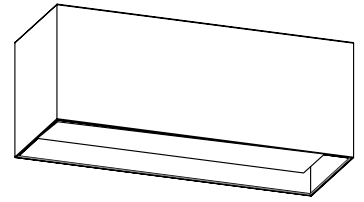

FLOATING DIFFUSER  
(ADJUSTABLE HEIGHT)

## CUSTOM INSPIRATION - SUSPENSIONS

CHOOSE FROM AN EXTENSIVE RANGE OF SUSPENSION TYPES, ALL WITH EMPHASIS ON HIGH QUALITY COMPONENTRY  
REFER TO OUR COMPONENT BROCHURES FOR DETAILS ON STANDARD FLEX, BRAIDED FLEX, PRINTED DECORATIVE FLEX, AND OUR PROPRIETARY SEAMLESS CANOPY

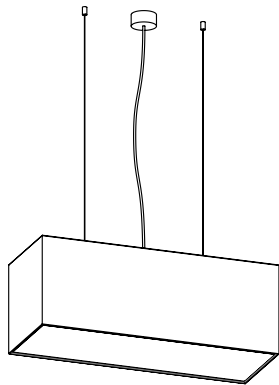

CABLES TO PUCKS

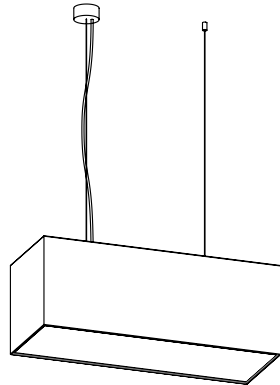

CABLE TO PUCK AND CANOPY

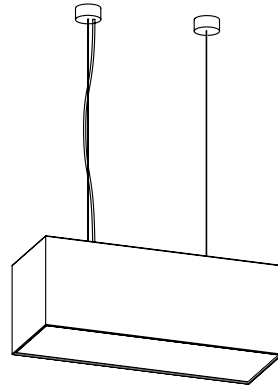

CABLES TO CANOPIES

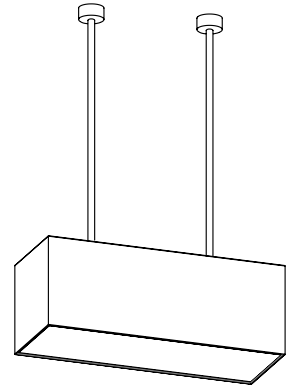

RODS TO CANOPIES

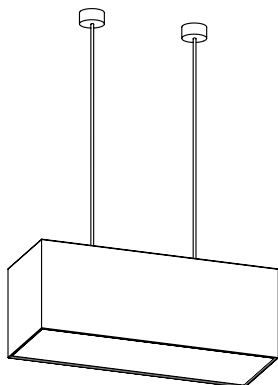

DOUBLE FLEX (FORE E27 DOUBLE DROP)

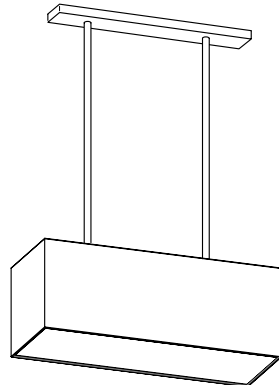

FULL CUSTOM CANOPY/SUSPENSION

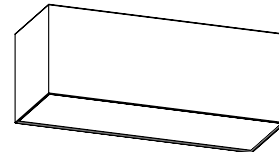

SURFACE MOUNT

## CUSTOM INSPIRATION - LIGHT SOURCES

OPTIMISE THE LIGHTING EFFECT FOR YOUR LUMINAIRE WITH ONE OF OUR STANDARD LIGHT SOURCES, OR CONTACT US TO DISCUSS BESPOKE ALTERNATIVES

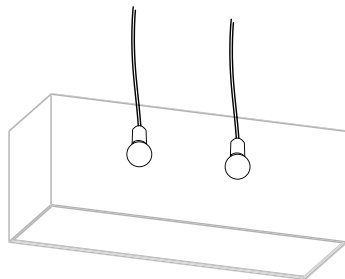

E27 DOUBLE DROP

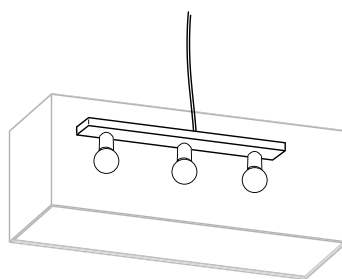

E27 BAR  
(NUMBER OF LAMP HOLDERS  
CAN BE CUSTOMISED)

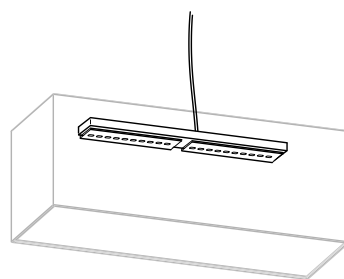

INTEGRATED LED

Rakumba has been producing custom-made feature lighting for the Australian design industry since 1968. Collaborating with designers across a wide range of sectors from commercial to residential, we take pride in our bespoke service, attention to design detailing and ability to deliver on any scale of project.

RP-E-1407P

## Ratio Taper Pendant Series



# Ratio Taper Pendant Series

ALL DIMENSIONS IN MILLIMETRES

RATIO TAPER 8-2: (700 x 250)T x (800 x 300)B x 300H  
 RATIO TAPER 8-3: (700 x 250)T x (800 x 300)B x 400H

STANDARD SPECIFICATION  
 EXTERIOR MATERIAL: RAKUMBA RANGE  
 INTERIOR MATERIAL: WHITE STYRENE OR CLEAR PVC BACKING  
 DIFFUSER MATERIAL: WHITE PARCHMENT  
 DIFFUSER STYLE: FLOATING  
 LIGHT SOURCE: 2 x E27 BAR // CFL GLOBES ARE RECOMMENDED MAX. 24W  
 SUSPENSION: SEAMLESS CANOPY // 2 x STEEL CABLES TO PUCKS // 1.5m CLEAR FLEX

RATIO TAPER 10-3: (900 x 250)T x (1000 x 300)B x 300H  
 RATIO TAPER 10-4: (900 x 250)T x (1000 x 300)B x 400H

STANDARD SPECIFICATION  
 EXTERIOR MATERIAL: RAKUMBA RANGE  
 INTERIOR MATERIAL: WHITE STYRENE OR CLEAR PVC BACKING  
 DIFFUSER MATERIAL: WHITE PARCHMENT  
 DIFFUSER STYLE: FLOATING  
 LIGHT SOURCE: 3 x E27 BAR // CFL GLOBES ARE RECOMMENDED MAX. 24W  
 SUSPENSION: SEAMLESS CANOPY // 2 x STEEL CABLES TO PUCKS // 1.5m CLEAR FLEX

RATIO TAPER 12-3: (1100 x 350)T x (1200 x 400)B x 300H  
 RATIO TAPER 12-4: (1100 x 350)T x (1200 x 400)B x 400H

STANDARD SPECIFICATION  
 EXTERIOR MATERIAL: RAKUMBA RANGE  
 INTERIOR MATERIAL: WHITE STYRENE OR CLEAR PVC BACKING  
 DIFFUSER MATERIAL: WHITE PARCHMENT  
 DIFFUSER STYLE: FLOATING  
 LIGHT SOURCE: 4 x E27 BAR // CFL GLOBES ARE RECOMMENDED MAX. 24W  
 SUSPENSION: SEAMLESS CANOPY // 2 x STEEL CABLES TO PUCKS // 1.5m CLEAR FLEX

RATIO TAPER 11-2: (1300 x 330)T x (1400 x 430)B x 500H

STANDARD SPECIFICATION  
 EXTERIOR MATERIAL: RAKUMBA RANGE  
 INTERIOR MATERIAL: WHITE STYRENE OR CLEAR PVC BACKING  
 DIFFUSER MATERIAL: WHITE PARCHMENT  
 DIFFUSER STYLE: FLOATING  
 LIGHT SOURCE: 4 x E27 BAR // CFL GLOBES ARE RECOMMENDED MAX. 24W  
 SUSPENSION: SEAMLESS CANOPY // 2 x STEEL CABLES TO PUCKS // 1.5m CLEAR FLEX

STANDARD PRODUCTS - ALL DIMENSIONS CAN BE CUSTOMISED

*Ratio Taper 8-3*

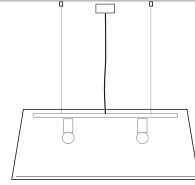

*Ratio Taper 8-4*

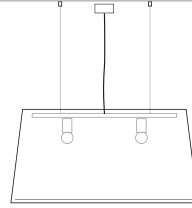

*Ratio Taper 10-3*

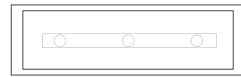
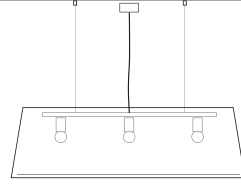

*Ratio Taper 10-4*

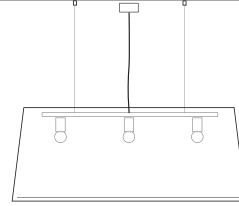

*Ratio Taper 12-3*

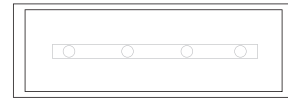
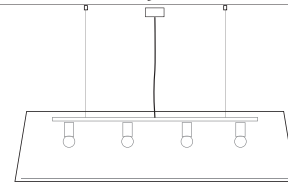

*Ratio Taper 12-4*

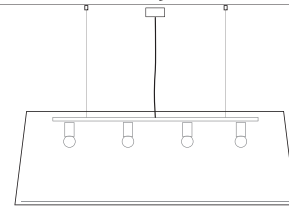

*Ratio Taper 14-5*

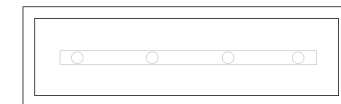
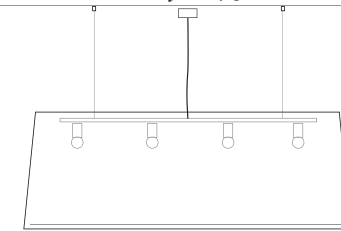



# Ratio Taper Pendant Series



Custom Ratio Taper for Residence (Surrey Lighting)

ALL PRODUCT DETAILS ARE HIGHLY CUSTOMISABLE ON REQUEST - THE ILLUSTRATIONS BELOW AND OVERLEAF HIGHLIGHT JUST SOME OF THE AVAILABLE METHODS.

## CUSTOM INSPIRATION - CORNERS

CREATE A DISTINCTIVE LOOK WITH OUR ALTERNATIVE CORNER DETAILS

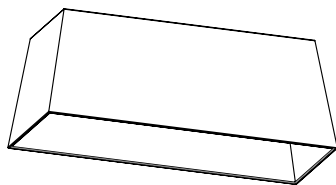

SQUARE

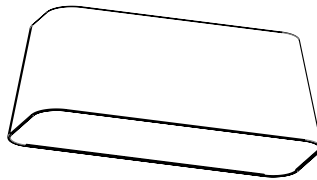

RADIUS

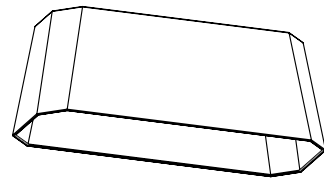

CHAMFER

## CUSTOM INSPIRATION - MATERIALS\*

SELECT FROM AUSTRALIA'S MOST COMPREHENSIVE RANGE OF SHADE MATERIALS, SUPPLY YOUR OWN, OR DESIGN CUSTOM PRINTS AND CUT PATTERNS FOR A UNIQUE FINISH

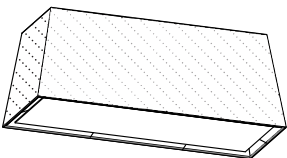

EXTERNAL MATERIAL

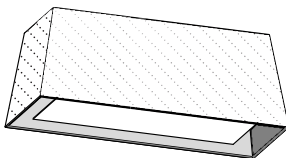

EXTERNAL & INTERNAL MATERIAL  
(RECOMMENDED WHEN DIFFUSER IS NOT FULL FIT)

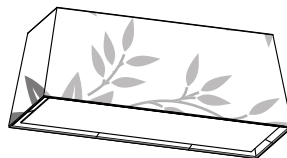

CUSTOM DIGITAL PRINT

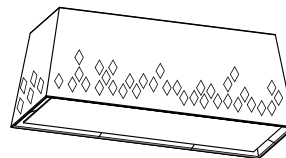

CUSTOM CNC CUT PATTERN  
(ALSO SEE RP-E-1306P 'MOTIF')

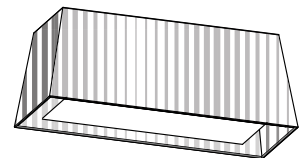

HAND PLEAT  
(VARIOUS STYLES AVAILABLE)

\*EDGE FINISH IS TAPED OR HAND-ROLLED (OPTIONAL)

# Ratio Taper Pendant Series

## CUSTOM INSPIRATION - DIFFUSERS

DIFFUSERS ARE AVAILABLE IN A WIDE RANGE OF PARCHMENTS, BONDED FABRICS, AND ACRYLICS (PMMA) IN VARYING SURFACE TEXTURES AND LIGHT TRANSMISSION LEVELS

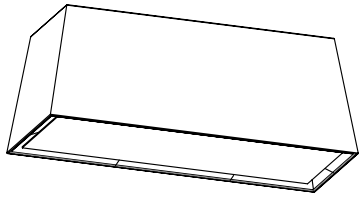

INSET DIFFUSER

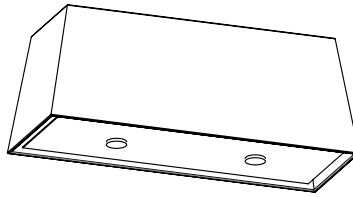

SUSPENDED DIFFUSER

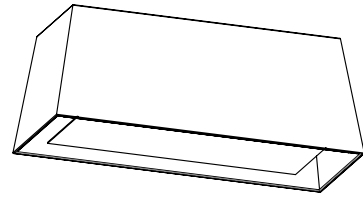

FLOATING DIFFUSER  
(ADJUSTABLE HEIGHT)

## CUSTOM INSPIRATION - SUSPENSIONS

CHOOSE FROM AN EXTENSIVE RANGE OF SUSPENSION TYPES, ALL WITH EMPHASIS ON HIGH QUALITY COMPONENTRY  
REFER TO OUR COMPONENT BROCHURES FOR DETAILS ON STANDARD FLEX, BRAIDED FLEX, PRINTED DECORATIVE FLEX, AND OUR PROPRIETARY SEAMLESS CANOPY

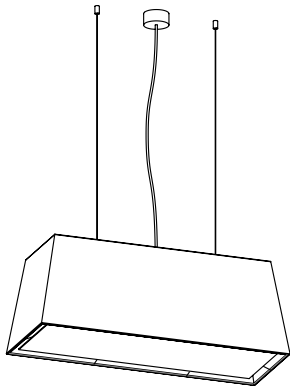

CABLES TO PUCKS

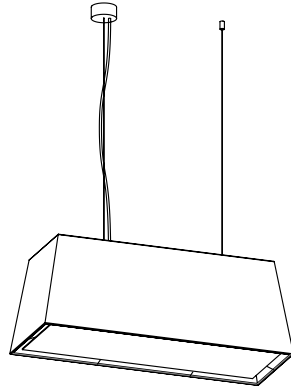

CABLESTO PUCKANDCANOPY

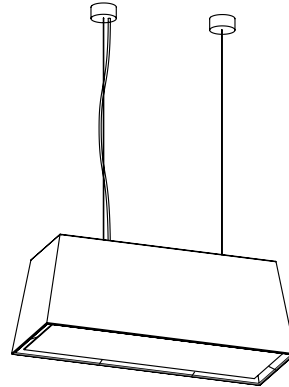

CABLES TO CANOPIES

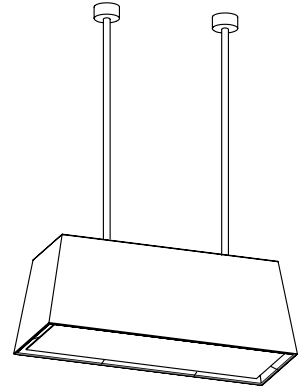

RODS TO CANOPIES

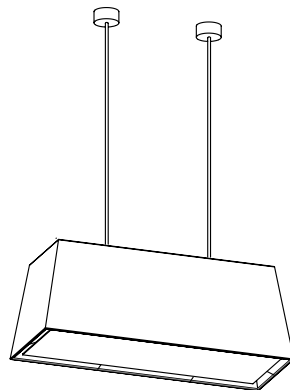

DOUBLE FLEX (FOR E27 DOUBLE DROP)

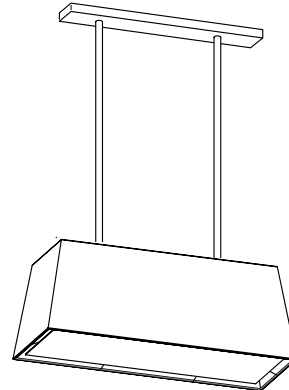

FULL CUSTOM CANOPY/SUSPENSION

## CUSTOM INSPIRATION - LIGHT SOURCES

OPTIMISE THE LIGHTING EFFECT FOR YOUR LUMINAIRE WITH ONE OF OUR STANDARD LIGHT SOURCES, OR CONTACT US TO DISCUSS BESPOKE ALTERNATIVES

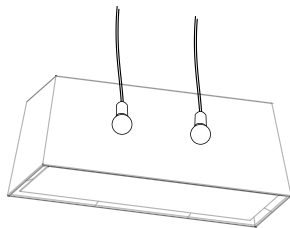

E27 DOUBLE DROP

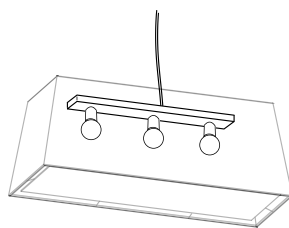

E27 BAR  
(NUMBER OF LAMP HOLDERS  
CAN BE CUSTOMISED)

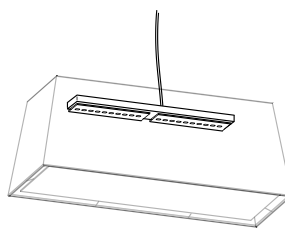

INTEGRATED LED

Rakumba has been producing custom-made feature lighting for the Australian design industry since 1968. Collaborating with designers across a wide range of sectors from commercial to residential, we take pride in our bespoke service, attention to design detailing and ability to deliver on any scale of project.

RP-E-1408P

## Stadium Pendant Series



# Stadium Pendant Series

ALL DIMENSIONS IN MILLIMETRES

STADIUM 8-2: 800 x 200 x 250H  
 STADIUM 8-3: 800 x 300 x 300H

**STANDARD SPECIFICATION**

EXTERIOR MATERIAL: RAKUMBA RANGE  
 INTERIOR MATERIAL: WHITE STYRENE OR CLEAR PVC BACKING  
 DIFFUSER MATERIAL: WHITE PARCHMENT  
 DIFFUSER STYLE: FULL-FIT  
 LIGHT SOURCE: 2 x E27 BAR // CFL GLOBES ARE RECOMMENDED MAX. 24W  
 SUSPENSION: SEAMLESS CANOPY // 2 x STEEL CABLES TO PUCKS // 1.5m CLEAR FLEX

STADIUM 9-2: 900 x 200 x 250H  
 STADIUM 9-3: 900 x 300 x 300H

**STANDARD SPECIFICATION**

EXTERIOR MATERIAL: RAKUMBA RANGE  
 INTERIOR MATERIAL: WHITE STYRENE OR CLEAR PVC BACKING  
 DIFFUSER MATERIAL: WHITE PARCHMENT  
 DIFFUSER STYLE: FULL-FIT  
 LIGHT SOURCE: 3 x E27 BAR // CFL GLOBES ARE RECOMMENDED MAX. 24W  
 SUSPENSION: SEAMLESS CANOPY // 2 x STEEL CABLES TO PUCKS // 1.5m CLEAR FLEX

STADIUM 10-2: 1000 x 200 x 250H  
 STADIUM 10-3: 1000 x 300 x 300H

**STANDARD SPECIFICATION**

EXTERIOR MATERIAL: RAKUMBA RANGE  
 INTERIOR MATERIAL: WHITE STYRENE OR CLEAR PVC BACKING  
 DIFFUSER MATERIAL: WHITE PARCHMENT  
 DIFFUSER STYLE: FULL-FIT  
 LIGHT SOURCE: 3 x E27 BAR // CFL GLOBES ARE RECOMMENDED MAX. 24W  
 SUSPENSION: SEAMLESS CANOPY // 2 x STEEL CABLES TO PUCKS // 1.5m CLEAR FLEX

STADIUM 11-2: 1100 x 200 x 250H  
 STADIUM 11-3: 1100 x 300 x 300H

**STANDARD SPECIFICATION**

EXTERIOR MATERIAL: RAKUMBA RANGE  
 INTERIOR MATERIAL: WHITE STYRENE OR CLEAR PVC BACKING  
 DIFFUSER MATERIAL: WHITE PARCHMENT  
 DIFFUSER STYLE: FULL-FIT  
 LIGHT SOURCE: 3 x E27 BAR // CFL GLOBES ARE RECOMMENDED MAX. 24W  
 SUSPENSION: SEAMLESS CANOPY // 2 x STEEL CABLES TO PUCKS // 1.5m CLEAR FLEX

STADIUM 12-2: 1200 x 200 x 250H  
 STADIUM 12-3: 1200 x 300 x 300H

**STANDARD SPECIFICATION**

EXTERIOR MATERIAL: RAKUMBA RANGE  
 INTERIOR MATERIAL: WHITE STYRENE OR CLEAR PVC BACKING  
 DIFFUSER MATERIAL: WHITE PARCHMENT  
 DIFFUSER STYLE: FULL-FIT  
 LIGHT SOURCE: 4 x E27 BAR // CFL GLOBES ARE RECOMMENDED MAX. 24W  
 SUSPENSION: SEAMLESS CANOPY // 2 x STEEL CABLES TO PUCKS // 1.5m CLEAR FLEX

STADIUM 15-2: 1500 x 200 x 250H  
 STADIUM 15-3: 1500 x 300 x 300H

**STANDARD SPECIFICATION**

EXTERIOR MATERIAL: RAKUMBA RANGE  
 INTERIOR MATERIAL: WHITE STYRENE OR CLEAR PVC BACKING  
 DIFFUSER MATERIAL: WHITE PARCHMENT  
 DIFFUSER STYLE: FULL-FIT  
 LIGHT SOURCE: 4 x E27 BAR // CFL GLOBES ARE RECOMMENDED MAX. 24W  
 SUSPENSION: SEAMLESS CANOPY // 2 x STEEL CABLES TO PUCKS // 1.5m CLEAR FLEX

STANDARD PRODUCTS - ALL DIMENSIONS CAN BE CUSTOMISED

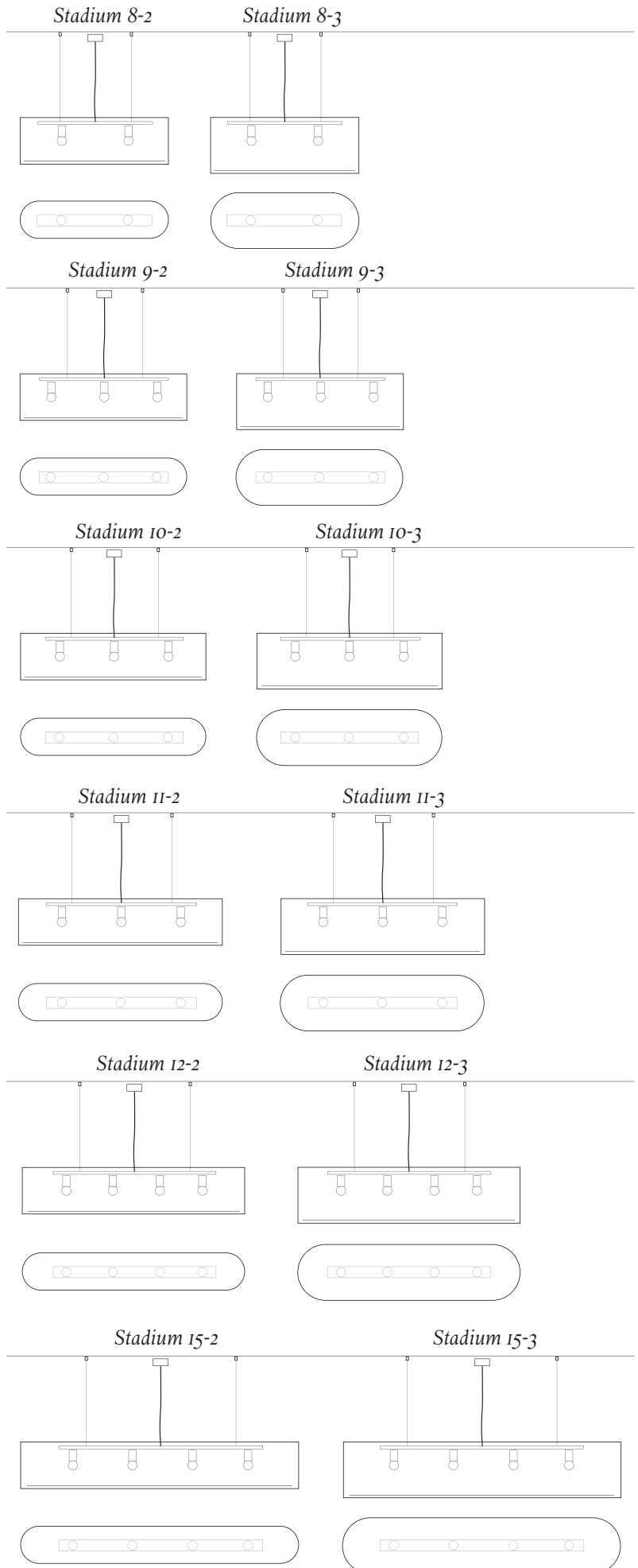

# Stadium Pendant Series



*Custom Stadium for Residence*

ALL PRODUCT DETAILS ARE HIGHLY CUSTOMISABLE ON REQUEST - THE ILLUSTRATIONS BELOW AND OVERLEAF HIGHLIGHT JUST SOME OF THE AVAILABLE METHODS.

## CUSTOM INSPIRATION - MATERIALS\*

SELECT FROM AUSTRALIA'S MOST COMPREHENSIVE RANGE OF SHADE MATERIALS, SUPPLY YOUR OWN, OR DESIGN CUSTOM PRINTS AND CUT PATTERNS FOR A UNIQUE FINISH

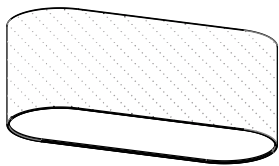

EXTERNAL MATERIAL

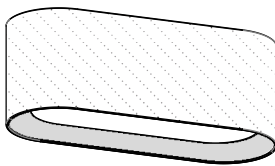

EXTERNAL & INTERNAL MATERIAL  
(RECOMMENDED WHEN DIFFUSER IS NOT FULL FIT)

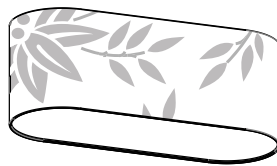

CUSTOM DIGITAL PRINT

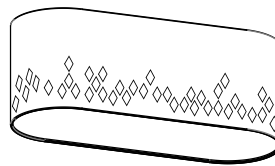

CUSTOM CNC CUT PATTERN  
(ALSO SEE RP-E-1306P 'MOTIF')

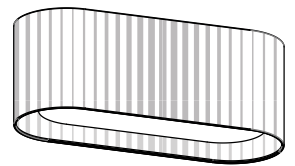

HAND PLEAT  
(VARIOUS STYLES AVAILABLE)

\*EDGE FINISH IS TAPED OR HAND-ROLLED (OPTIONAL)

# Stadium Pendant Series

## CUSTOM INSPIRATION - DIFFUSERS

DIFFUSERS ARE AVAILABLE IN A WIDE RANGE OF PARCHMENTS, BONDED FABRICS, AND ACRYLICS IN VARYING SURFACE TEXTURES AND LIGHT TRANSMISSION LEVELS

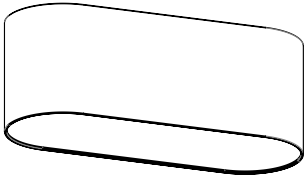

FULL FIT DIFFUSER

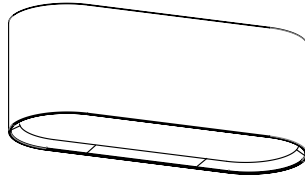

INSET DIFFUSER

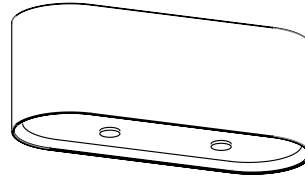

SUSPENDED DIFFUSER

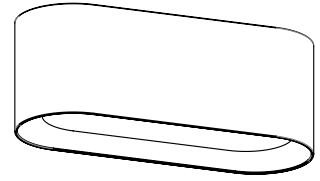

FLOATING DIFFUSER  
(ADJUSTABLE HEIGHT)

## CUSTOM INSPIRATION - SUSPENSIONS

CHOOSE FROM AN EXTENSIVE RANGE OF SUSPENSION TYPES, ALL WITH EMPHASIS ON HIGH QUALITY COMPONENTRY  
REFER TO OUR COMPONENT BROCHURES FOR DETAILS ON STANDARD FLEX, BRAIDED FLEX, PRINTED DECORATIVE FLEX, AND OUR PROPRIETARY SEAMLESS CANOPY

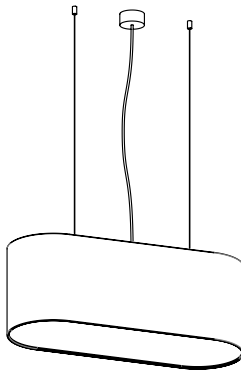

CABLES TO PUCKS

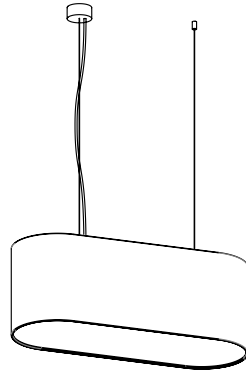

CABLES TO PUCK AND  
CANOPY

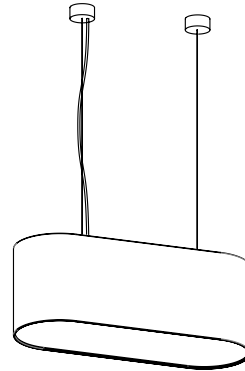

CABLES TO CANOPIES

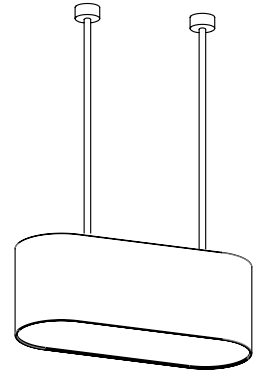

RODS TO CANOPIES

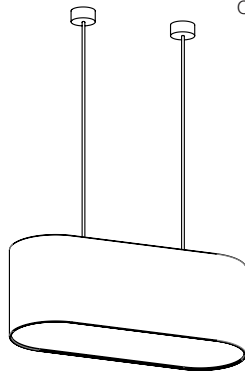

DOUBLE FLEX (FOR E27 DOUBLE  
DROP)

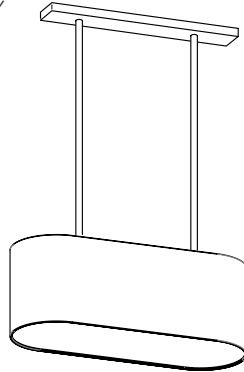

FULL CUSTOM CANOPY/  
SUSPENSION



SURFACE MOUNT

## CUSTOM INSPIRATION - LIGHT SOURCES

OPTIMISE THE LIGHTING EFFECT FOR YOUR LUMINAIRE WITH ONE OF OUR STANDARD LIGHT SOURCES, OR CONTACT US TO DISCUSS BESPOKE ALTERNATIVES

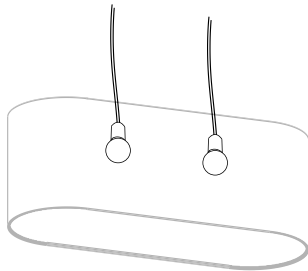

E27 DOUBLE DROP

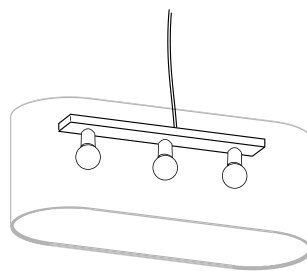

E27 BAR  
(NUMBER OF LAMPHOLDERS  
CAN BE CUSTOMISED)

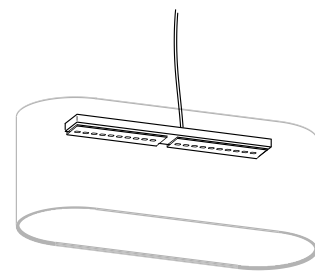

INTEGRATED LED

Rakumba has been producing custom-made feature lighting for the Australian design industry since 1968. Collaborating with designers across a wide range of sectors from commercial to residential, we take pride in our bespoke service, attention to design detailing and ability to deliver on any scale of project.

RP-E-1409P

## Stadium Taper Pendant Series



# Stadium Taper Pendant Series

ALL DIMENSIONS IN MILLIMETRES

STADIUM TAPER 8-2: (700 x 250)T x (800 x 300)B x 300H  
 STADIUM TAPER 8-3: (700 x 250)T x (800 x 300)B x 400H

**STANDARD SPECIFICATION**

EXTERIOR MATERIAL: RAKUMBA RANGE  
 INTERIOR MATERIAL: WHITE STYRENE OR CLEAR PVC BACKING  
 DIFFUSER MATERIAL: WHITE PARCHMENT  
 DIFFUSER STYLE: FLOATING  
 LIGHT SOURCE: 2 x E27 BAR // CFL GLOBES ARE RECOMMENDED MAX. 24W  
 SUSPENSION: SEAMLESS CANOPY // 2 x STEEL CABLES TO PUCKS // 1.5m CLEAR FLEX

STADIUM TAPER 10-3:(900 x 250)T x (1000 x 300)B x 300H  
 STADIUM TAPER 10-4:(900 x 250)T x (1000 x 300)B x 400H

**STANDARD SPECIFICATION**

EXTERIOR MATERIAL: RAKUMBA RANGE  
 INTERIOR MATERIAL: WHITE STYRENE OR CLEAR PVC BACKING  
 DIFFUSER MATERIAL: WHITE PARCHMENT  
 DIFFUSER STYLE: FLOATING  
 LIGHT SOURCE: 3 x E27 BAR // CFL GLOBES ARE RECOMMENDED MAX. 24W  
 SUSPENSION: SEAMLESS CANOPY // 2 x STEEL CABLES TO PUCKS // 1.5m CLEAR FLEX

STADIUM TAPER 12-3:(1100 x 350)T x (1200 x 400)B x 300H  
 STADIUM TAPER 12-4:(1100 x 350)T x (1200 x 400)B x 400H

**STANDARD SPECIFICATION**

EXTERIOR MATERIAL: RAKUMBA RANGE  
 INTERIOR MATERIAL: WHITE STYRENE OR CLEAR PVC BACKING  
 DIFFUSER MATERIAL: WHITE PARCHMENT  
 DIFFUSER STYLE: FLOATING  
 LIGHT SOURCE: 4 x E27 BAR // CFL GLOBES ARE RECOMMENDED MAX. 24W  
 SUSPENSION: SEAMLESS CANOPY // 2 x STEEL CABLES TO PUCKS // 1.5m CLEAR FLEX

STADIUM TAPER 11-2:(1300 x 330)T x (1400 x 430)B x 500H

**STANDARD SPECIFICATION**

EXTERIOR MATERIAL: RAKUMBA RANGE  
 INTERIOR MATERIAL: WHITE STYRENE OR CLEAR PVC BACKING  
 DIFFUSER MATERIAL: WHITE PARCHMENT  
 DIFFUSER STYLE: FLOATING  
 LIGHT SOURCE: 4 x E27 BAR // CFL GLOBES ARE RECOMMENDED MAX. 24W  
 SUSPENSION: SEAMLESS CANOPY // 2 x STEEL CABLES TO PUCKS // 1.5m CLEAR FLEX

STANDARD PRODUCTS - ALL DIMENSIONS CAN BE CUSTOMISED

*Stadium Taper 8-3*

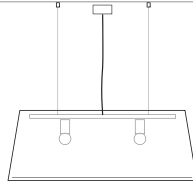

*Stadium Taper 8-4*

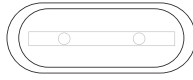
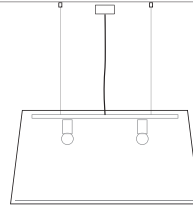

*Stadium Taper 10-3*

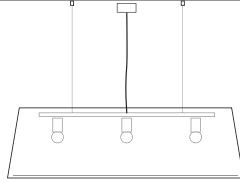

*Stadium Taper 10-4*

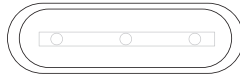
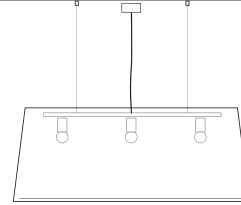

*Stadium Taper 12-3*

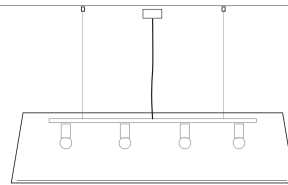

*Stadium Taper 12-4*

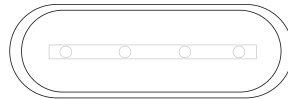
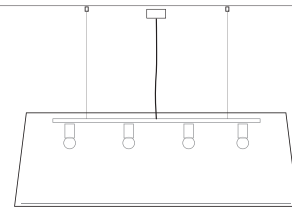

*Stadium Taper 14-5*

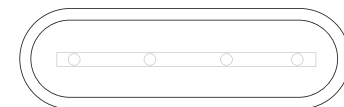
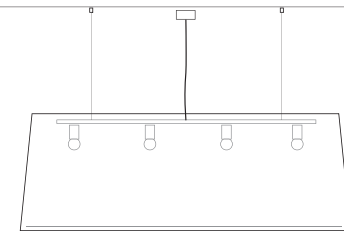



# Stadium Taper Pendant Series



*Custom Stadium Taper 14-5 for Apartment Rollout (Inlite)*

ALL PRODUCT DETAILS ARE HIGHLY CUSTOMISABLE ON REQUEST - THE ILLUSTRATIONS BELOW AND OVERLEAF HIGHLIGHT JUST SOME OF THE AVAILABLE METHODS.

## CUSTOM INSPIRATION - MATERIALS\*

SELECT FROM AUSTRALIA'S MOST COMPREHENSIVE RANGE OF SHADE MATERIALS, SUPPLY YOUR OWN, OR DESIGN CUSTOM PRINTS AND CUT PATTERNS FOR A UNIQUE FINISH

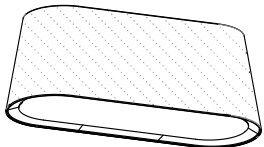

EXTERNAL MATERIAL

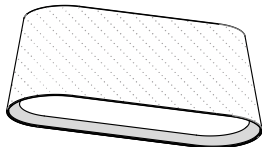

EXTERNAL & INTERNAL MATERIAL  
(RECOMMENDED WHEN DIFFUSER  
IS NOT FULL FIT)

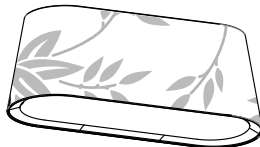

CUSTOM DIGITAL PRINT

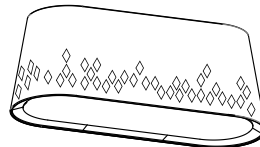

CUSTOM CNC CUT PATTERN  
(ALSO SEE RP-E-1306P  
'MOTIF')

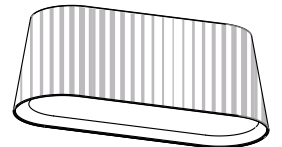

HAND PLEAT  
(VARIOUS STYLES AVAILABLE)

\*EDGE FINISH IS TAPED OR HAND-ROLLED (OPTIONAL)

# Stadium Taper Pendant Series

## CUSTOM INSPIRATION - DIFFUSERS

DIFFUSERS ARE AVAILABLE IN A WIDE RANGE OF PARCHMENTS, BONDED FABRICS, AND ACRYLICS (PMMA) IN VARYING SURFACE TEXTURES AND LIGHT TRANSMISSION

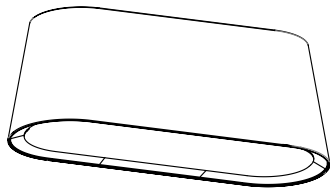

INSET DIFFUSER

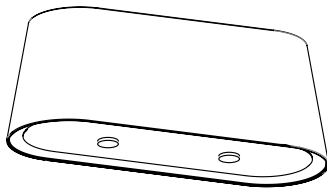

SUSPENDED DIFFUSER

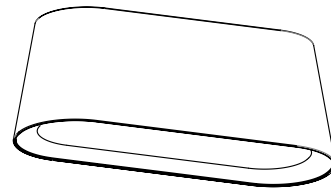

FLOATING DIFFUSER  
(ADJUSTABLE HEIGHT)

## CUSTOM INSPIRATION - SUSPENSIONS

CHOOSE FROM AN EXTENSIVE RANGE OF SUSPENSION TYPES, ALL WITH EMPHASIS ON HIGH QUALITY COMPONENTRY  
REFER TO OUR COMPONENT BROCHURES FOR DETAILS ON STANDARD FLEX, BRAIDED FLEX, PRINTED DECORATIVE FLEX, AND OUR PROPRIETARY SEAMLESS CANOPY

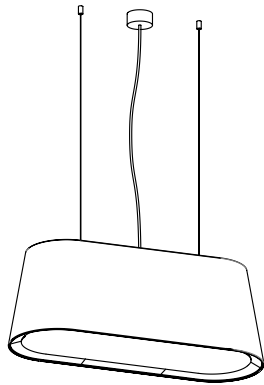

CABLES TO PUCKS

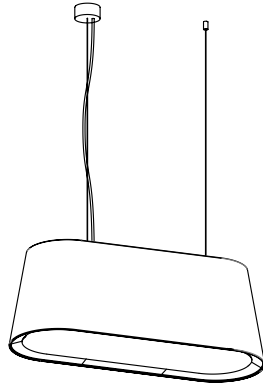

CABLES TO PUCK AND  
CANOPY

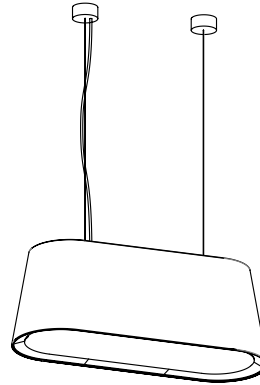

CABLES TO CANOPIES

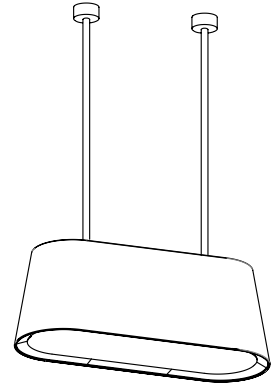

RODS TO CANOPIES

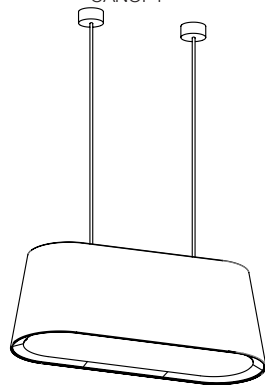

DOUBLE FLEX (FOR E27 DOUBLE  
DROP)

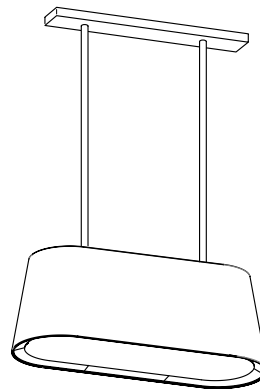

FULL CUSTOM CANOPY/  
SUSPENSION

## CUSTOM INSPIRATION - LIGHT SOURCES

OPTIMISE THE LIGHTING EFFECT FOR YOUR LUMINAIRE WITH ONE OF OUR STANDARD LIGHT SOURCES, OR CONTACT US TO DISCUSS BESPOKE ALTERNATIVES

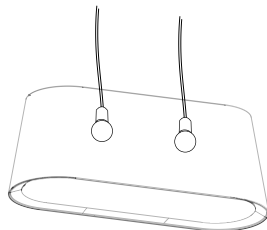

E27 DOUBLE DROP

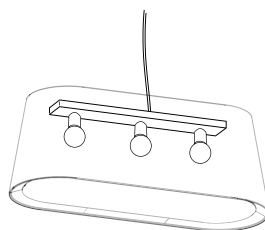

E27 BAR  
(NUMBER OF LAMPHOLDERS  
CAN BE CUSTOMISED)

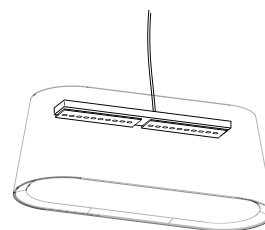

INTEGRATED LED

Rakumba has been producing custom-made feature lighting for the Australian design industry since 1968. Collaborating with designers across a wide range of sectors from commercial to residential, we take pride in our bespoke service, attention to design detailing and ability to deliver on any scale of project.





RP-E-1401W

## Switch







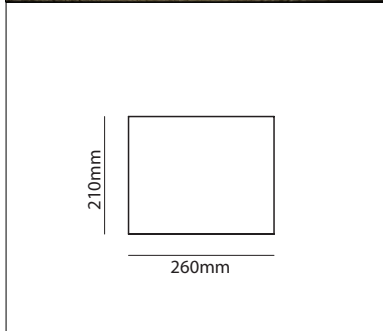
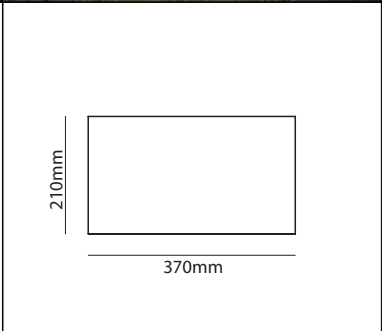
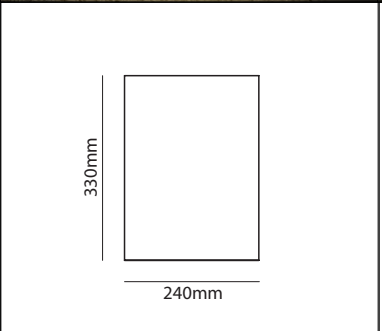
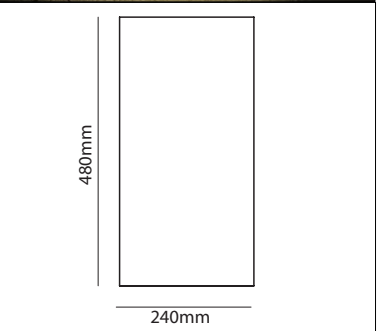



# Switch

ORDERING OPTION 1 - SIZE (custom sizes also available)

			
<i>Classic</i>	<i>Wide</i>	<i>Tall</i>	<i>Double</i>
			

ORDERING OPTION 2 - PROFILE (custom profiles also available)

			
<i>Square</i>	<i>Radius</i>	<i>Return</i>	<i>Chamfer</i>
			

PRODUCT TECHNICAL SPECIFICATION

**NAME:** SWITCH  
**STYLE:** WALL LIGHT (HIDDEN BRACKET)  
**MATERIALS & FINISH:** BRACKET - POWDERCOATED STEEL  
 SHADE - CUSTOMISABLE FABRIC (CONTACT RAKUMBA FOR EXTENSIVE RANGE OF OPTIONS)  
 DIFFUSER- OPTIONAL  
**LIGHT SOURCES:** STANDARD - CLASSIC, WIDE, TALL // 1 X E27 // 240v // CFL GLOBES RECOMMENDED MAX. 24W  
 DOUBLE // 2 X E27 // 240v // CFL GLOBES RECOMMENDED MAX. 24W  
 OPTIONAL - CLASSIC, WIDE, TALL // TRIDONIC LED // 240V INTEGRATED CONVERTER // 12.8W // 1460lm // 3000K  
 DOUBLE // TRIDONIC LED // 240V INTEGRATED CONVERTER // 25.6W // 2920lm // 3000K

Rakumba has been producing custom-made feature lighting for the Australian design industry since 1968. Collaborating with designers across a wide range of sectors from commercial to residential, we take pride in our bespoke service, attention to design detailing and ability to deliver on any scale of project.

RP-E-1308P

**Tessellate Series**



# Tessellate Series

## DIMENSIONS

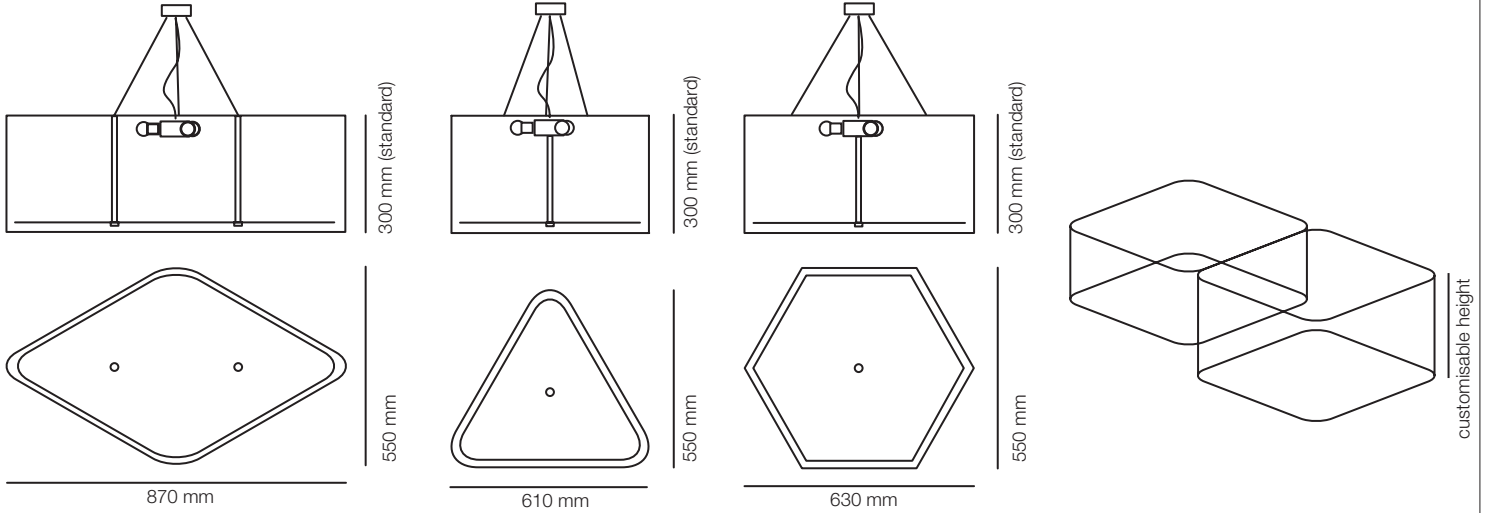

## TESSELLATION EXAMPLE ARRANGEMENTS

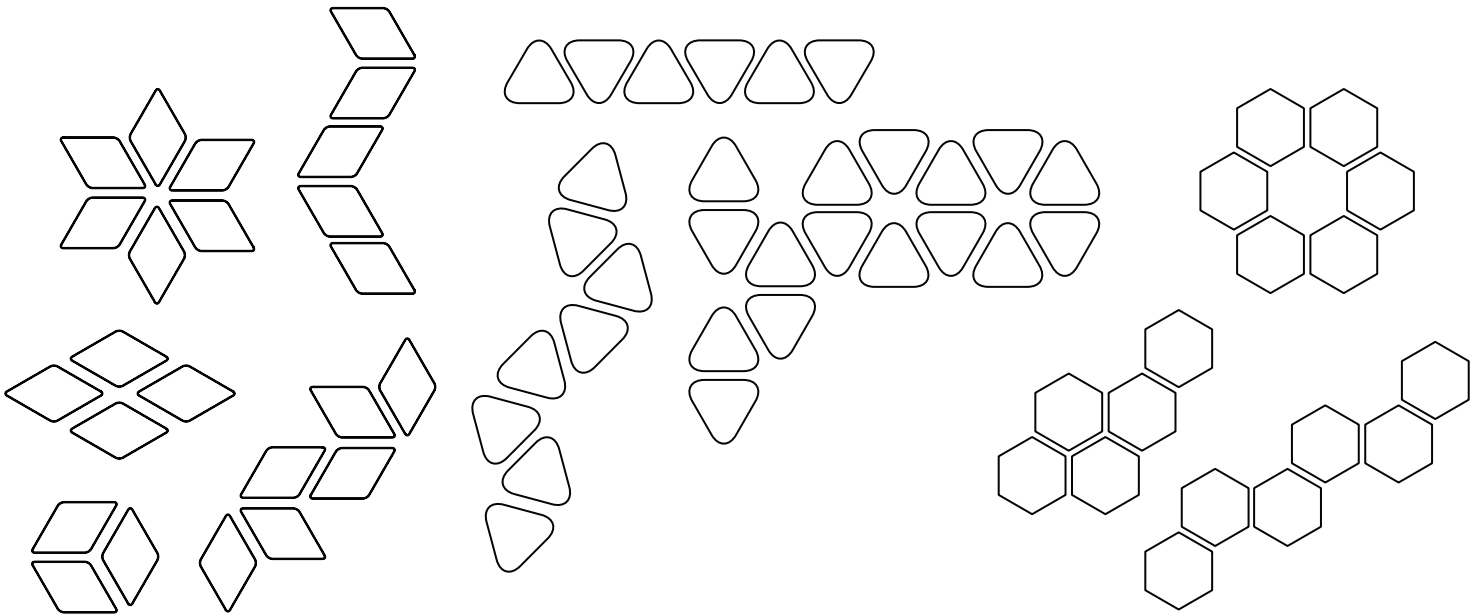

## PRODUCT TECHNICAL SPECIFICATION

NAME:	TESSELLATE SERIES	
STYLE:	PENDANT	
MATERIALS & FINISH:	SHADE -	CUSTOMISABLE FABRIC (CONTACT RAKUMBA FOR EXTENSIVE RANGE OF OPTIONS)
	DIFFUSER -	OPAL PMMA (ACRYLIC)
LIGHT SOURCE:	STANDARD -	3 X E27 HUB // 240V // CFL GLOBES RECOMMENDED MAX. 24W
	OPTION -	TRIDONIC LED DISK // 240V CONVERTER (INTEGRATED) // 29.2W // 3800lm // 3000K // DIMMING OPTIONS AVAILABLE
SUSPENSION:	STANDARD -	4 X STEEL CABLES // 1.5m BRAIDED TEXTILE FLEX // SEAMLESS CANOPY
	OPTION -	ROD SUSPENSION (LENGTH CUSTOMISABLE)

Rakumba has been producing custom-made feature lighting for the Australian design industry since 1968. Collaborating with designers across a wide range of sectors from commercial to residential, we take pride in our bespoke service, attention to design detailing and ability to deliver on any scale of project.