



# Frame

Designed by Justin Hutchinson  
for Kett  
2022

Exclusive to Cosh Living  
[coshliving.com.au](http://coshliving.com.au)

## Bedroom

**The Frame Bedroom collection integrates storage and technology into a seamless furniture solution for the home.**

Frame allows a personalised solution to furniture and joinery needs by offering a wide range of functions and finishes to complement the bedroom.

Frame is the outcome of our research into innovative connection systems that afford an exact and robust method of installation for many interior walls, from plasterboard through to masonry.

Sustainability and health are key considerations in the development of Frame, with materials free of formaldehyde, phenols, solvents, PVC or melamine.

Frame defines the room by allowing the surrounding walls to express the space, making Frame much lighter than traditional wall-to-wall joinery.

Designed & Made in Australia

5 Panel A

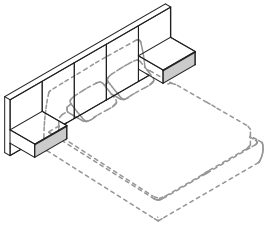

300

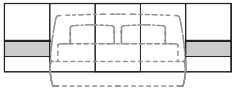

FB-90-5P-A

\*Queen Bed pictured - all other drawings shown with a King Bed.  
 \*\*1795 opening between drawers - all other configurations at 2100. See p.6.

6 Panel A

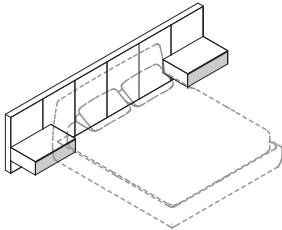

360

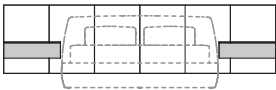

FB-90-6P-A

6 Panel B

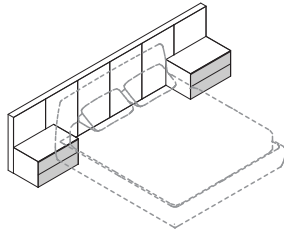

360

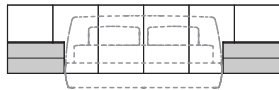

FB-90-6P-B

6 Panel C Left

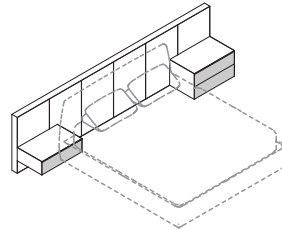

360

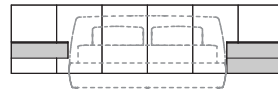

FB-90-6P-C-L

6 Panel C Right

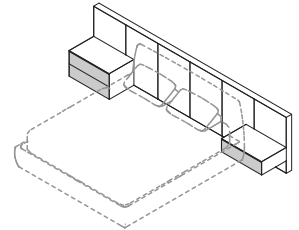

360

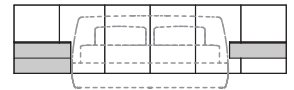

FB-90-6P-C-R

7 Panel A Left

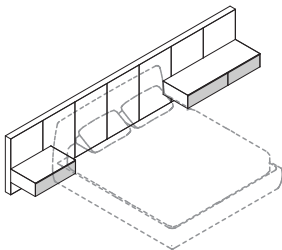

420

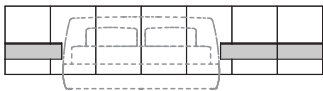

FB-90-7P-A-L

7 Panel A Right

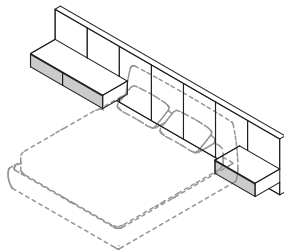

420

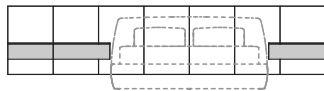

FB-90-7P-A-R

7 Panel B Left

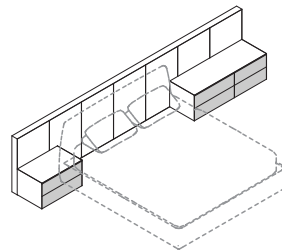

420

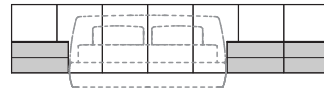

FB-90-7P-B-L

7 Panel B Right

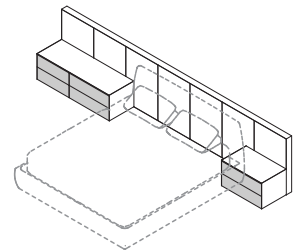

420

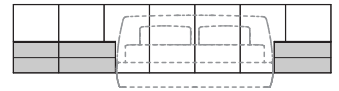

FB-90-7P-B-R

7 Panel C Left

7 Panel C Right

7 Panel D Left

7 Panel D Right

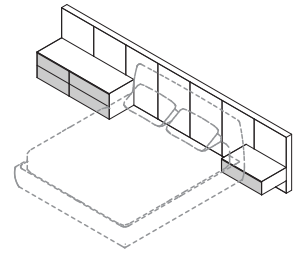
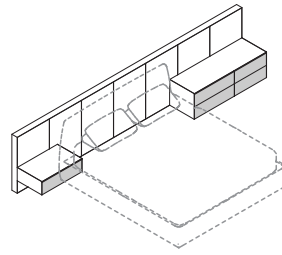
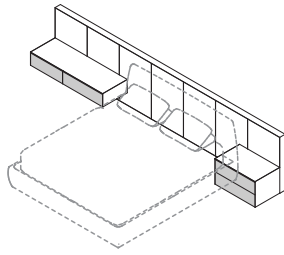
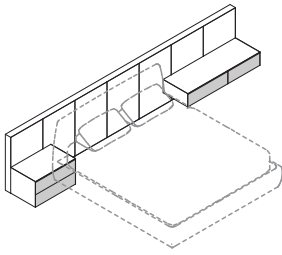

420

420

420

420

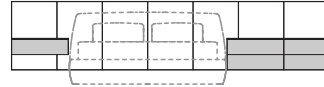
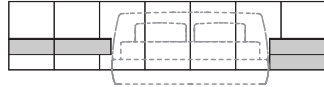
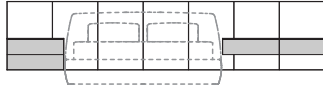

FB-90-7P-C-L

FB-90-7P-C-R

FB-90-7P-D-L

FB-90-7P-D-R

8 Panel A

8 Panel B

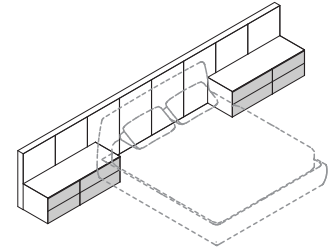
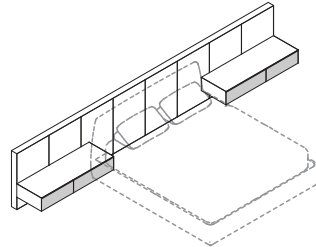

480

480



FB-90-8P-A

FB-90-8P-B

8 Panel C Left

8 Panel C Right

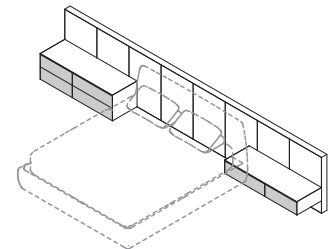
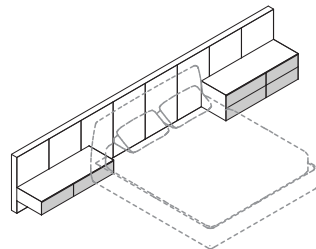

480

480

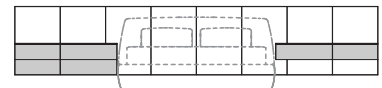
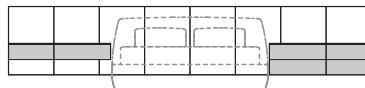

FB-90-8P-C-L

FB-90-8P-C-R

Natural Oak



Lt Walnut

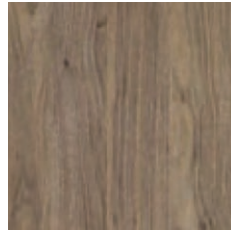

Charcoal Oak

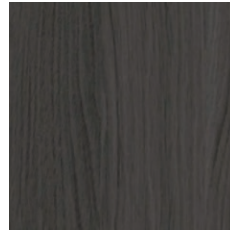

Exhibition

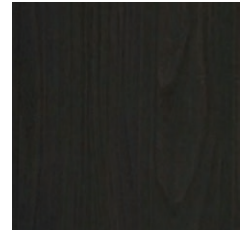

## Porcelain

Calacatta Oro Venato



Bianco Statuario Venato



Marquinia

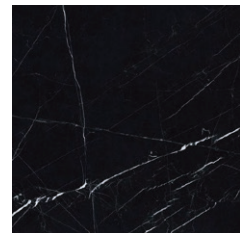

## Powder Coat

City (Red)



Mangrove (Green)

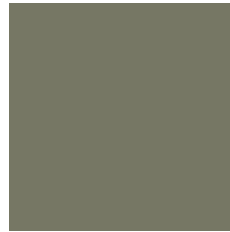

Ocean (Blue)



Black

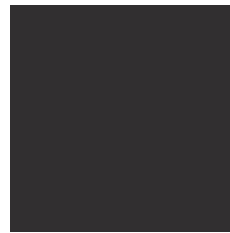

White

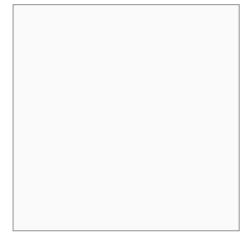

### Guide Only

This is an indicative guide only. Please refer to physical Kett samples for a more accurate representation of actual finishes.

## Technical

Discover Kett at  
[kettfurniture.com.au](http://kettfurniture.com.au)

Exclusive to Cosh Living  
[coshliving.com.au](http://coshliving.com.au)

### Materials

Powder coated metal frame; wall panels, cabinets and drawer fronts are constructed of a cellulose fibre face and an E0 MRMDF substrate.

### Porcelain Surface

Calacatta Oro Venato (Soft Touch)  
 Bianco Statuario Venato (Soft Touch)  
 Marquinia

### Timber Finishes

Natural Oak  
 Lt Walnut  
 Charcoal Oak  
 Exhibition

### Powder Coat

Mangrove (Green)  
 Ocean (Blue)  
 City (Red)  
 Black  
 White

### E.g. Supply the following per module

Rear Panels - Charcoal Oak  
 Door Fronts - Lt Walnut  
 Porcelain Surface - Marquinia  
 Powder Coat - City (Red)

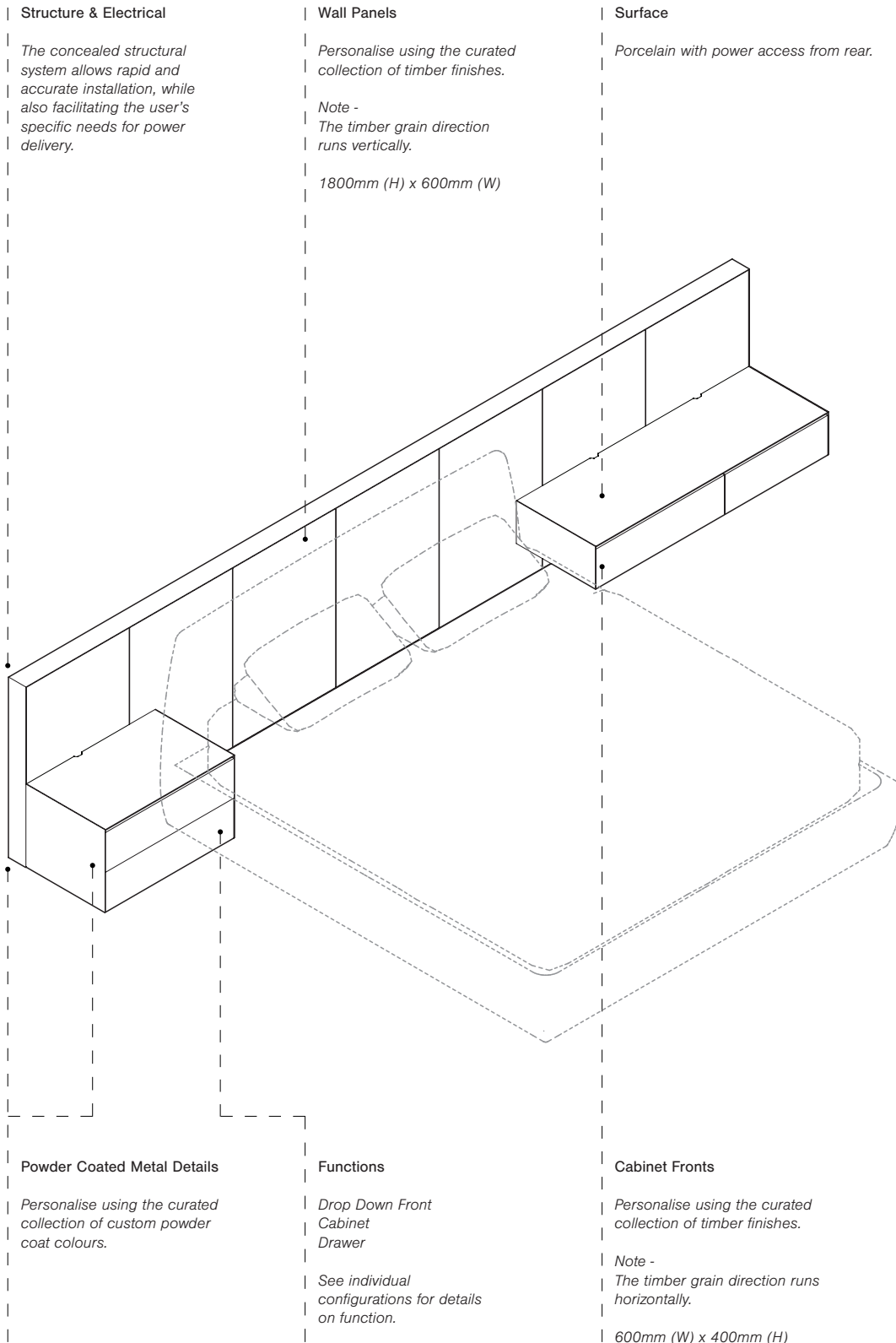

Erskine Bed (Queen)

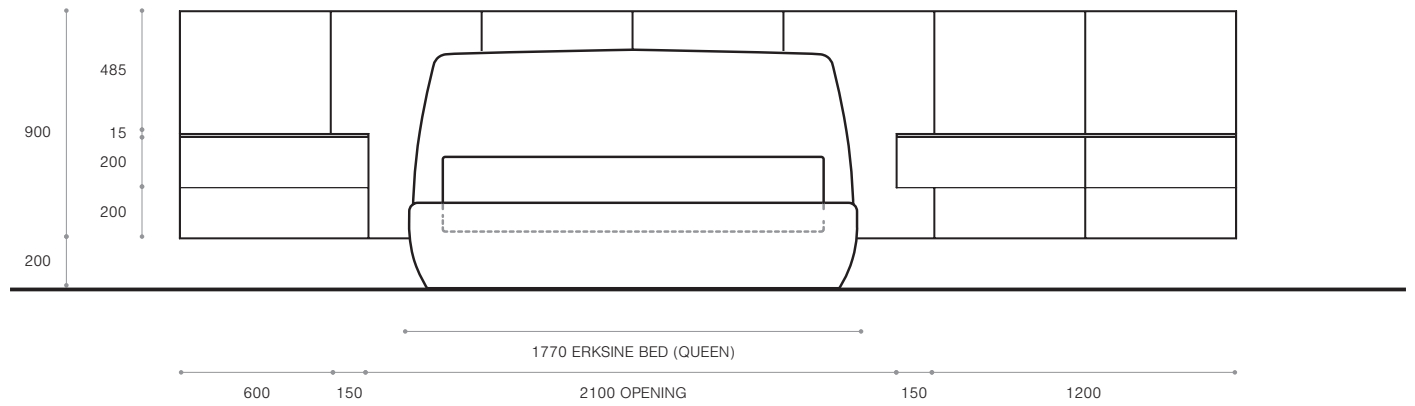

Erskine Bed (King)

