



# Frame

Designed by Justin Hutchinson  
for Kett  
2022

Exclusive to Cosh Living  
[coshliving.com.au](http://coshliving.com.au)

## Home Office

**The Frame Home Office collection integrates storage, technology and display into a seamless furniture solution for the home.**

Frame allows a personalised solution to furniture and joinery needs by offering a wide range of functions and finishes to complement the home office. Frame is the outcome of our research into innovative connection systems that afford an exact and robust method of installation for many interior walls, from plasterboard through to masonry.

Sustainability and health are key considerations in the development of Frame, with materials free of formaldehyde, phenols, solvents, PVC or melamine. Frame defines the room by allowing the surrounding walls to express the space, making Frame much lighter than traditional wall-to-wall joinery.

Designed & Made in Australia

| Fixed Desk 70D                       | Standalone 80D                       | 3 Panel Work Left                    | 3 Panel Work Right                   |
|--------------------------------------|--------------------------------------|--------------------------------------|--------------------------------------|
|                                      |                                      |                                      |                                      |
| 180<br>75                            | 180<br>75                            | 180                                  | 180                                  |
| FO-180-FDESK-T                       | AI-180-SDESK-T                       | FO-180-3P-W-L<br>+ FO-180-FDESK-T    | FO-180-3P-W-R<br>+ FO-180-FDESK-T    |
| 4 Panel Work & Store Left            | 4 Panel Work & Store Right           | 5 Panel Work & Store A Left          | 5 Panel Work & Store A Right         |
|                                      |                                      |                                      |                                      |
| 240                                  | 240                                  | 300                                  | 300                                  |
| FO-180-4P-WS-L<br>+ FO-180-FDESK-T   | FO-180-4P-WS-R<br>+ FO-180-FDESK-T   | FO-180-5P-WS-A-L<br>+ FO-180-FDESK-T | FO-180-5P-WS-A-R<br>+ FO-180-FDESK-T |
| 5 Panel Work & Store B Left          | 5 Panel Work & Store B Right         | 5 Panel Work & Display Left          | 5 Panel Work & Display Right         |
|                                      |                                      |                                      |                                      |
| 300                                  | 300                                  | 300                                  | 300                                  |
| FO-180-5P-WS-B-L<br>+ FO-180-FDESK-T | FO-180-5P-WS-B-R<br>+ FO-180-FDESK-T | FO-180-5P-WD-L<br>+ FO-180-FDESK-T   | FO-180-5P-WD-R<br>+ FO-180-FDESK-T   |

All Frame Office modules are available with a fixed desk, standalone desk, or no desk.  
All areas shaded in grey are pinboard material.

7 Panel Work & Store Left

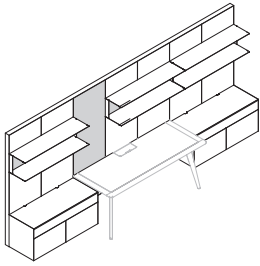

420

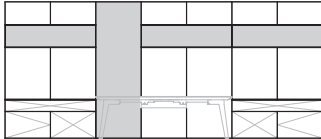

FO-180-7P-WS-L  
+ FO-180-FDESK-T

7 Panel Work & Store Right

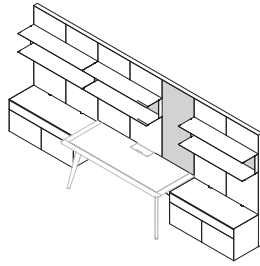

420



FO-180-7P-WS-R  
+ FO-180-FDESK-T

7 Panel Work, Store & Display Left

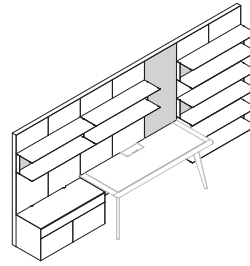

420

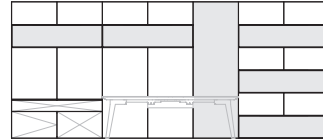

FO-180-7P-WS-D-L  
+ FO-180-FDESK-T

7 Panel Work, Store & Display Right

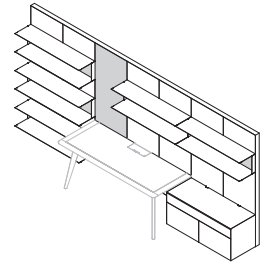

420

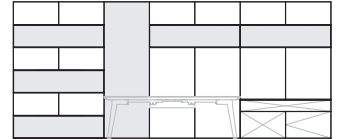

FO-180-7P-WS-D-R  
+ FO-180-FDESK-T

4 Panel Store Left

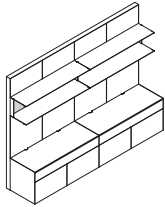

240

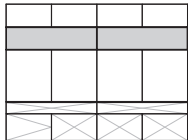

FO-180-4P-S-L

4 Panel Store Right

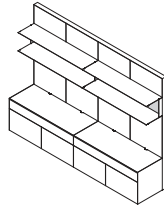

240

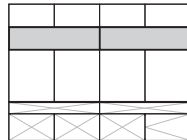

FO-180-4P-S-R

2 Panel Store Left

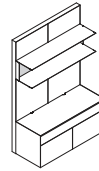

120

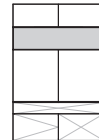

FO-180-2P-S-L

2 Panel Store Right

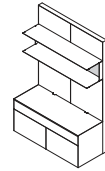

120

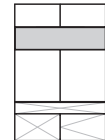

FO-180-2P-S-R

2 Panel Display

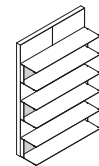

120

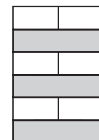

FO-180-2P-D

4 Panel Display

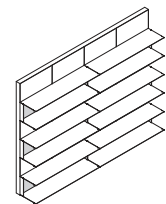

240

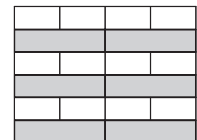

FO-180-4P-D

All Frame Office modules are available with a fixed desk, standalone desk, or no desk.  
All areas shaded in grey are pinboard material.

Two Desk

6 Panel Two Person Work

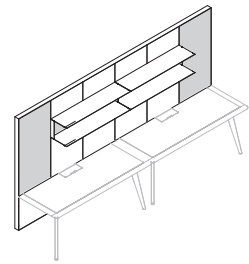

300

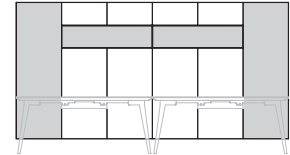

FO-180-6P-2W  
+ 2 x FO-180-FDESK-T

8 Panel Two Person Work & Display

8 Panel Two Person Work & Store Left

8 Panel Two Person Work & Store Right

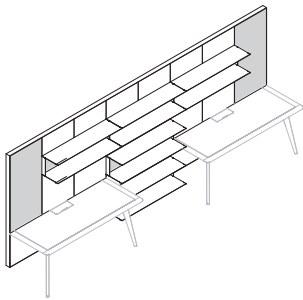

480

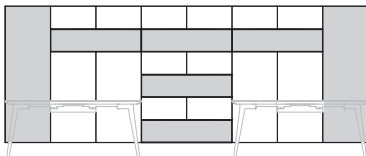

FO-180-8P-2WD  
+ 2 x FO-180-FDESK-T

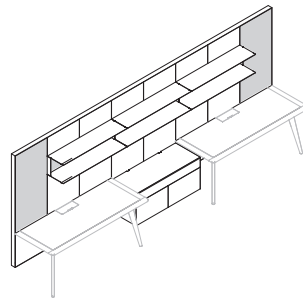

480

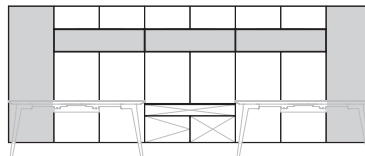

FO-180-8P-2WS-L  
+ 2 x FO-180-FDESK-T

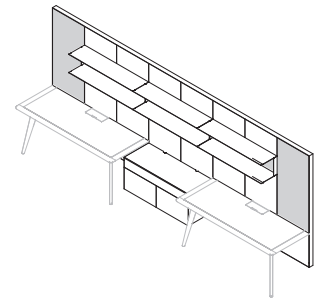

480

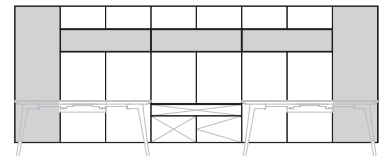

FO-180-8P-2WS-R  
+ 2 x FO-180-FDESK-T

All Frame Office modules are available with a fixed desk, standalone desk, or no desk.  
All areas shaded in grey are pinboard material.

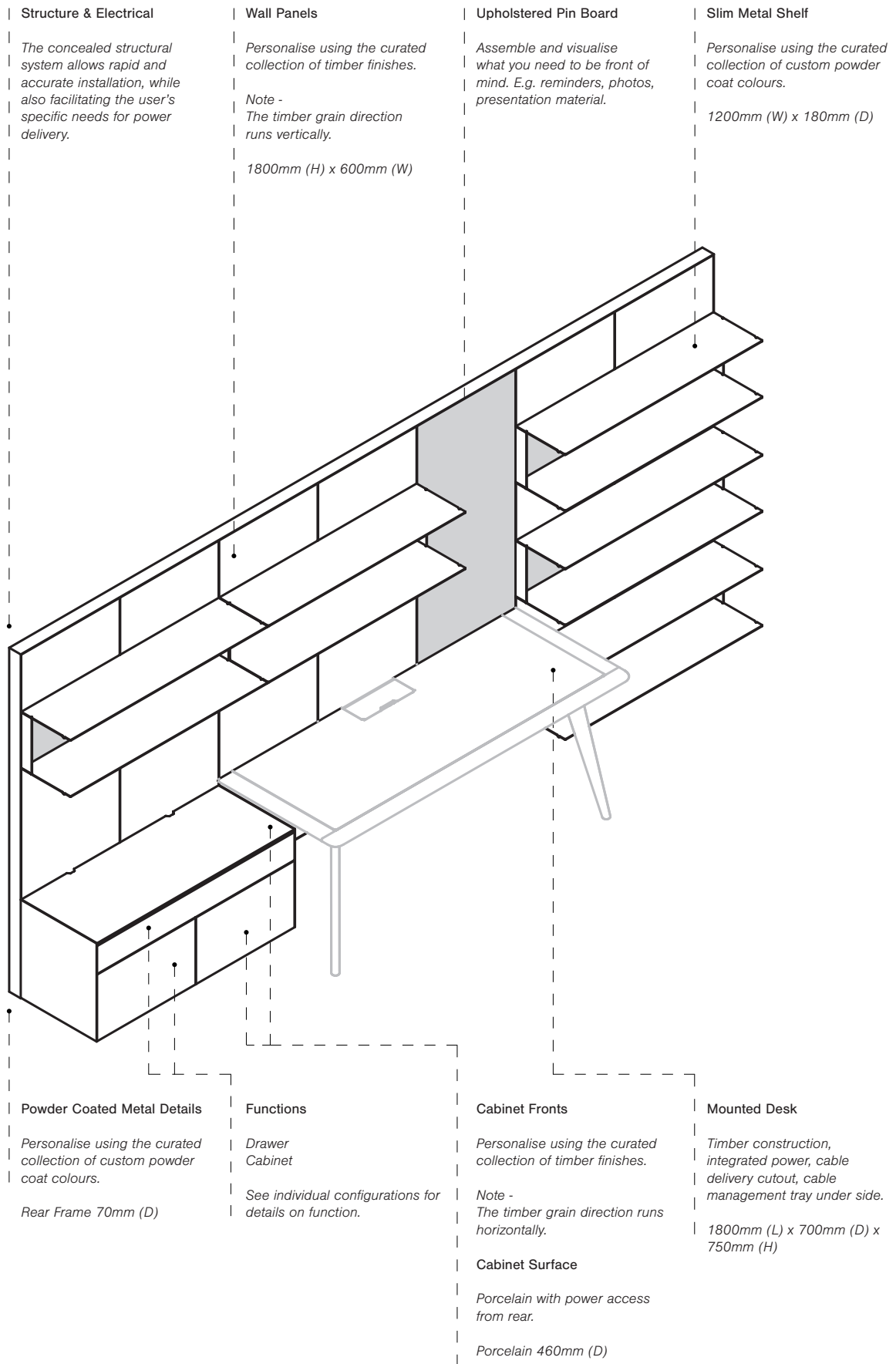

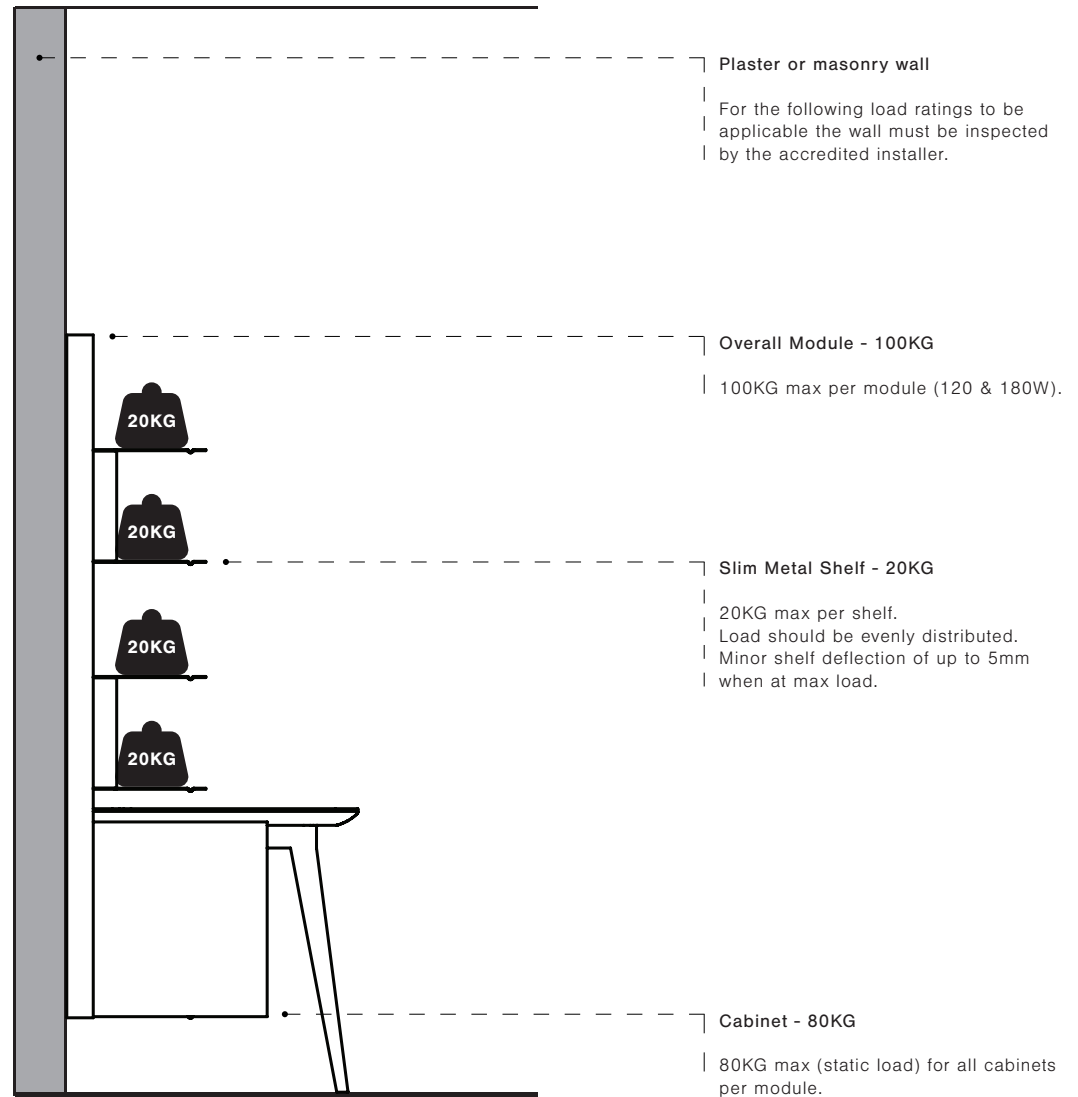

**Structural System**

Frame's concealed structural system distributes loads vertically and horizontally across several points, utilising best in class cavity fixings. Frame has a particular advantage in the case of plasterboard walls.

Stud locations are not critical to the installation, allowing Frame to be securely positioned anywhere horizontally on a wall.

Masonry, brick or concrete walls provide ample structure for Frame to fix to.

**Typical Weights**

|                                      | Overall Module         | Slim Metal Shelf      | Cabinet                |
|--------------------------------------|------------------------|-----------------------|------------------------|
| A. Magazine (250g)                   | A. 400 Magazines       | A. 80 Magazines       | A. 320 Magazines       |
| B. Paperback Book - 400 pages (300g) | B. 333 Paperback Books | B. 66 Paperback Books | B. 267 Paperback Books |
| C. Hardback Book - 400 pages (700g)  | C. 143 Hardback Books  | C. 28 Hardback Books  | C. 114 Hardback Books  |
| D. Vinyl Record (150g)               | D. 667 Vinyl Records   | D. 134 Vinyl Records  | D. 533 Vinyl Records   |
| E. Wine Bottle 750ml (1.25kg)        | E. 80 Wine Bottles     | E. 16 Wine Bottles    | E. 64 Wine Bottles     |



Panels

Natural



Lt Walnut



Charcoal Oak



Exhibition

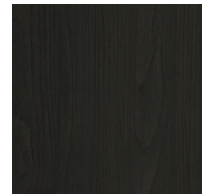

Porcelain

Calacatta Oro Venato



Bianco Statuario Venato



Marquinia

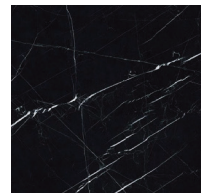

Powder Coat

City (Red)

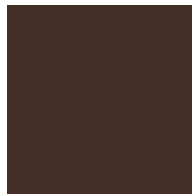

Mangrove (Green)

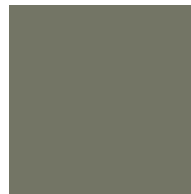

Ocean (Blue)



Black



White

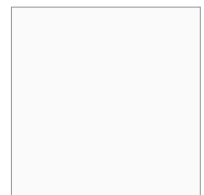

Guide Only

This is an indicative guide only. Please refer to physical Kett samples for a more accurate representation of actual finishes.

## Pin Board

Belgian Linen Bark

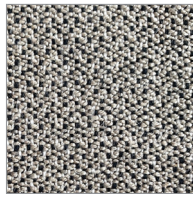

Belgian Linen Fern

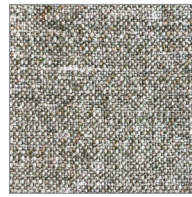

Belgian Linen Storm

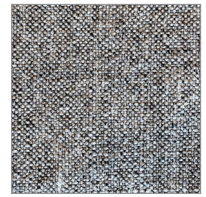

## Desks

Natural

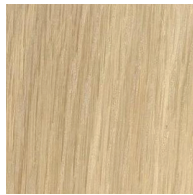

Light Walnut

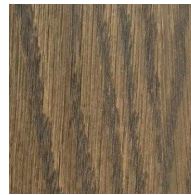

Exhibition



## Desk Inlay

Brusio Barley Leather



Natur Erba Leather



Brusio Anitra Leather

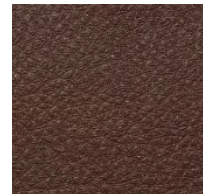

### Guide Only

This is an indicative guide only.  
Please refer to physical Kett samples  
for a more accurate representation of  
actual finishes.