

Technical Data Sheet

Model BTC43/40 – COMBINATION TOILET GRAB RAIL

AS1428.-1-2009 Compliant



Description: Configured Combination Grab Rail for use in toilet applications for disabled, aged care facilities and home assist use.

Size: 950mm Horizontal x 700mm Vertical x 40 Deg Rise plus 300mm Straight Grab Rail

Materials: 304 Grade Satin Stainless Steel Tubing
76 x 3mm Concealed Flange

Finishes Available: 32mm Diameter Tube
32mm Diameter 1428 Knurled
Mirror Polishing (No.9 Finish)
Also available in Powdercoated Colours

NOTE:

To the extent permitted by law Bendtech does not provide any warranty in relation to bolts, screws or other fasteners provided with Bendtech products. You should obtain appropriate advice from a licensed trade person before affixing or installing.

Models

324 BTC43/40 CF
329 BTC43/40 CF
324K BTC43/40 CF
329K BTC43/40 CF

32mm Stain Stainless Steel, Flange and Cover
32mm Mirror Polished, Flange and Cover
32mm 1428 Knurled Stainless, Flange and Cover
32mm 1428 Knurled Mirror Polished, Flange and Cover

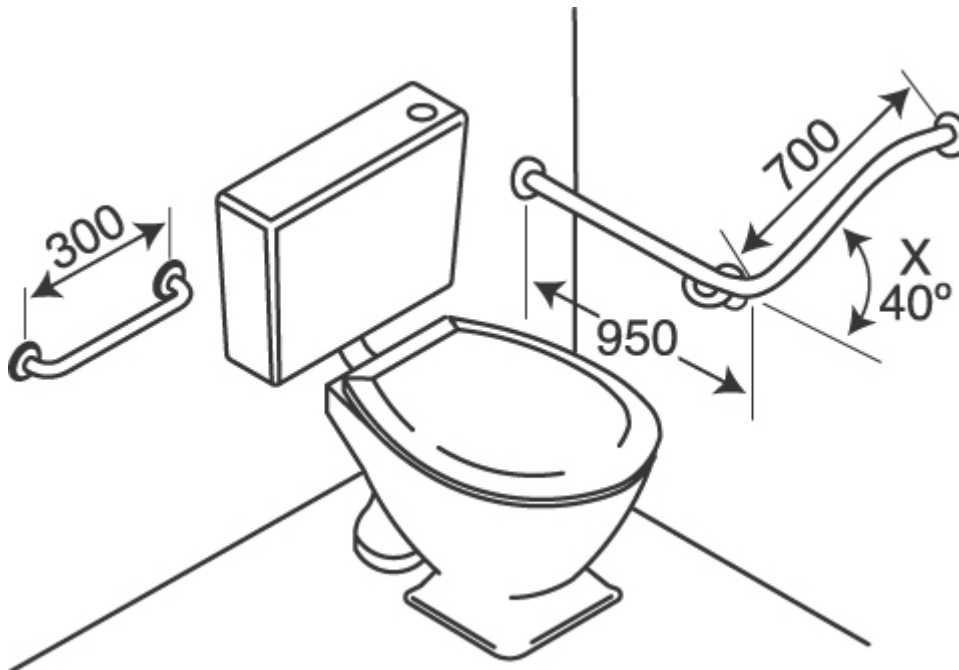

7 Barrinia Street Slacks Creek QLD 4127
Phone: (07) 3290 4007 Fax: (07) 3290 4001
Email: info@bendtech.com.au web: www.bendtech.com.au