

Installation Instructions

MODEL BT6 – TOILET GRAB RAIL

AS1428.1 Compliant

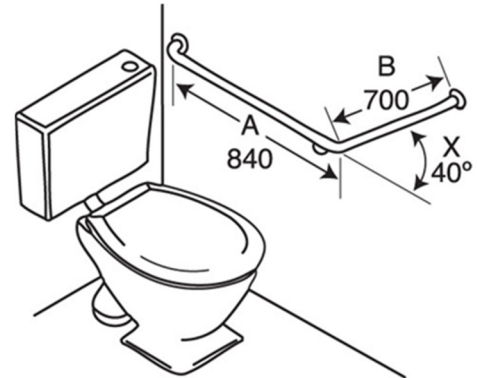

LHS (as per diagram above), RHS (Opposite to diagram above)

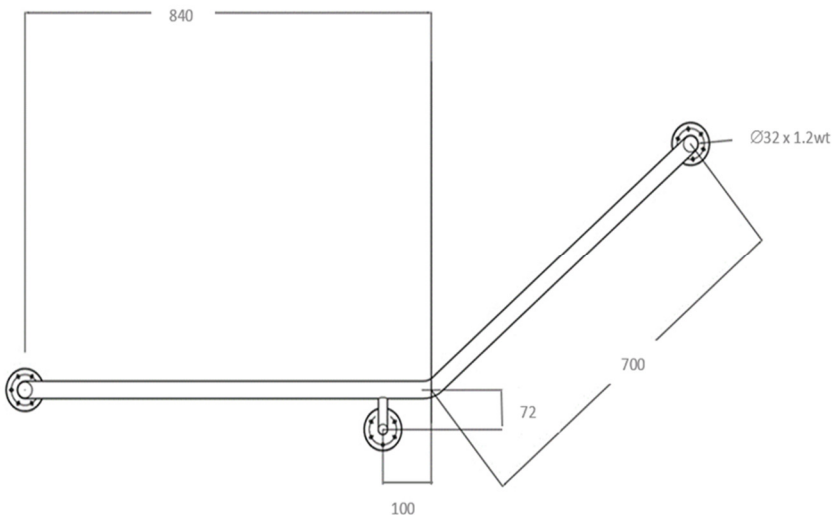

Description:

Configured Grab Rail for use in toilet applications for disabled, aged care facilities and home assist use.

Size:

840mm Horizontal x 700mm Vertical x 40 Deg Rise.

Materials:

304 Grade Satin Stainless Steel tubing.
76 x 3mm Concealed Flange

To meet requirements of AS1428.1

1. Install at height of 800-810mm to top of rail from floor level.
2. Fixings need to be able to withstand a force of 1100N applied at any position and in any direction. (Note: Fixings not included)
3. Clearance between grabrail and the adjacent wall surface or obstruction shall be not less than 50mm or more than 60mm.

It is very important that a spacing block is utilised behind the rail to ensure that the rail is parallel to the wall surface as wall surfaces and squareness can vary. This can be adjusted on installation by an experienced tradesperson. The wall to the inside of the rail is 55mm on standard Bendtech Rails.

Note: To the extent permitted by law Bendtech does not provide any warranty in relation to bolts, screws or other fasteners provided with Bendtech products. You should obtain appropriate advice from a licensed trade person before affixing or installing.