

BT4/40

Product Specification

Specification

Fully welded construction in grade 304 stainless steel tube, 32mm diameter. Slip resistant Satin Stainless Steel with flange covers. Easy to install on most building surfaces (fixings supplied by others) designed for maximum strength and user confidence. Length 950mm to back wall x 700mm rail 40 degree angled WC one piece grab rail. Conforms to AS1428.1-2009. Bendtech™ products are made to the highest standards and currently the only TGA registered grab rail manufacturer in Australia.

Options

Polished stainless steel, powder coated finish, knurled or sure grip finishes. Available in Clean Seal flange system (see Clean Seal specification sheet BT4/40 CS 32mm diameter), available Exposed Fix or Vandal Proof.

Guarantee

Bendtech™ products are fully guaranteed against faulty workmanship and material defects subject to normal wear and tear of the product for a period of 5 years.

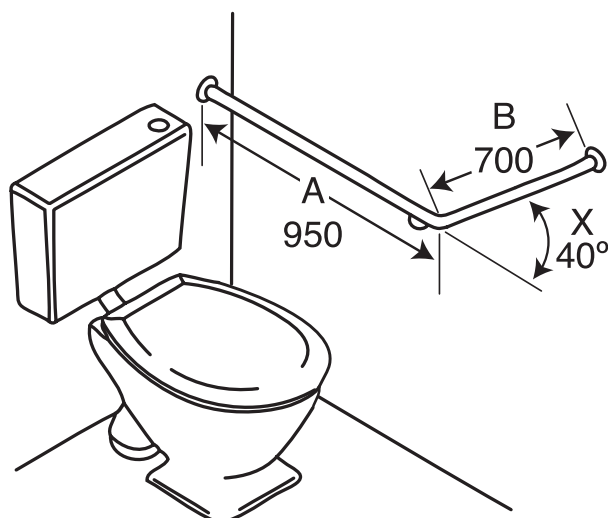

Left Hand Image Shown

