



STORAGE

AUS FILE™



Filing Cabinet



 FEATURES

- SGS Tested to comply with AS5079.2-2003 (exceeds the standard by 5Kg per drawer)
- Anti-tilt feature to prevent tipping
- Full width steel handle
- Full Extension Ball Bearing slides
- Lockable - Master key and Keyed alike option available.
- 35Kg weight loading tested. (Recommend 30Kg max.)
- One piece, full sided drawer allows for alternative storage use
- Positive drawer retention

 SPECIFICATIONS

Product	Height	Width	Depth	Lineal Metre Filing
4 Drawer	1320	470	620	2.16
3 Drawer	1020	470	620	1.62
2 Drawer	720	470	620	1.08



- 10 Years
- Covers material and workmanship
- Does not cover misuse or abuse

• NTY & CI IN OF CUSTODY CCF stralia CF stralia. PC



STORAGE

AUS FILE™



Lateral Filing Cabinet



Lateral Filing Cabinet

FEATURES

- SGS Tested to comply with AS 5079.1-2003
- Anti-tilt feature to prevent tipping on each side of drawer
- Positive drawer retention
- Full extension ball bearing slides
- Full width steel handle
- Adjustable feet for levelling
- Lockable - Master key and Keyed alike option available
- 35Kg weight loading tested (Recommend 30Kg max.)
- One piece, full sided drawer allows for alternative storage use
- Left to Right or Front to Back filing
- Accommodates other filing
- All steel construction
- All panels replaceable and recyclable
- Can be disassembled without special tools
- Powder coated finish
- Stock colours: Graphite Ripple, Silver and Pearl White



SPECIFICATIONS

- Dimensions nominal

Product	Height	Width	Depth	Lineal Metre Filing
4 Drawer	1320	900	480	3.34
3 Drawer	1020	900	480	2.51
2 Drawer	685	900	480	1.67

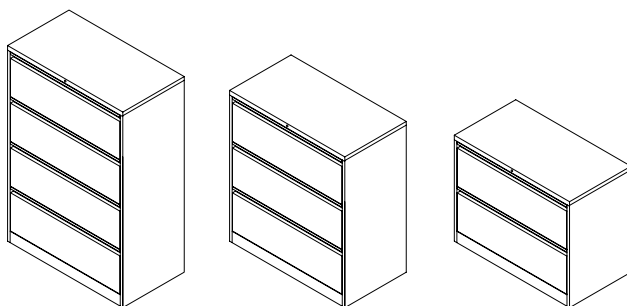

WARRANTY & CHAIN OF CUSTODY

PCF Australia is committed to product stewardship. We will undertake recycling of PCF Australia products at the end of the products life. The only cost is the freight to PCF Australia.

- 5 Years
- Does not cover misuse or abuse
- Covers material and workmanship
- Copy of full commercial warranty available on request



STORAGE

AUS FILE™

Mobile Pedestal

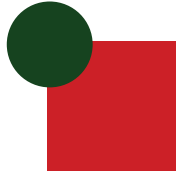

Mobile Pedestal

FEATURES

- Sleek European design with the emphasis on space and aesthetics
- 3 Drawer and 2 Drawer available
- All drawers have full extension ball bearing runners with 25kg capacity
- Top personal drawer has pencil tray
- Fifth castor to prevent tipping
- Stylish side pull drawer handles
- Lockable
- One piece, full sided drawer allows for alternative storage use
- Positive drawer retention
- All steel construction
- Powder coated finish
- Recyclable
- Stock colours:
Silver – Pearl White – Graphite Ripple
Other colours available on request
Volume dependent

SPECIFICATIONS

- Dimensions nominal

Product	Height	Width	Depth
3 Drawer	603	390	570
2 Drawer	680	390	570

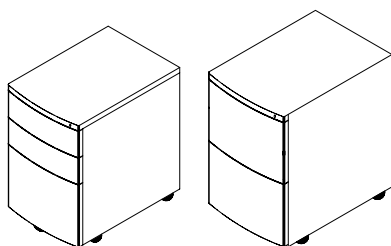

WARRANTY & CHAIN OF CUSTODY

PCF Australia is committed to product stewardship. We will undertake recycling of PCF Australia products at the end of the products life. The only cost is the freight to PCF Australia.

- 5 Years
- Does not cover misuse or abuse
- Covers materials and workmanship
- Copy of full commercial warranty available on request



STORAGE

AUS FILE™



Steel Cupboards



Executive Cupboard



Steel Cupboards

FEATURES

- Store just about anything; ringbinders, folders, boxes, stationery
- Multiple options for filing & storage
- Flush mounted locks
- Modular all steel construction
- Can be disassembled without special tools
- 3 Point locking
- All panels replaceable and recyclable
- Master key and Keyed alike option available
- Powder coated finish
- Height adjustable shelving, and accessories
- Reinforced doors
- Accessories simply clip in
- Shelf accommodates standard lateral suspension pocket
- Stock colours:
Beige – Grey – Black
Graphite Ripple – Pearl White
- Executive Cupboards with Space for Hanging and 2 Adjustable half shelves

SPECIFICATIONS

- Dimensions nominal

Product	Height	Width	Depth
4 Levels	1950	915	457
3 Levels	1830	915	457
2 Levels	1020	915	457
Exec Cupboard	1950	915	457
Exec Cupboard	1830	915	457

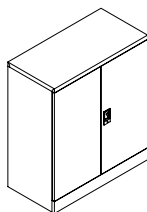
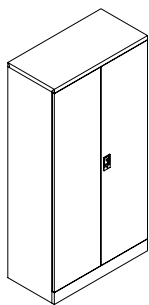
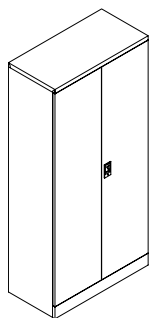

• Door lock

WARRANTY & CHAIN OF CUSTODY

PCF Australia is committed to product stewardship. We will undertake recycling of PCF Australia products at the end of the products life. The only cost is the freight to PCF Australia.

- 5 Years
- Does not cover misuse or abuse
- Covers material and workmanship
- Copy of full commercial warranty available on request



Tambour Cupboards





STORAGE

AUS FILE™



Lockers



PCF AUSTRALIA

Lockers

SPECIFICATIONS

- Customised options available depending on volume
- Dimensions nominal

Tier	Height	Width	Depth
1	1800	300 or 375	450
2	1800	300 or 375	450
3	1800	300 or 375	450
4	1800	300 or 375	450
2 Step	1800	375	450

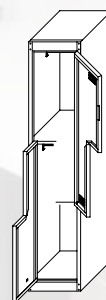
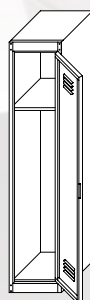



STORAGE

AUS FILE™



Pigeon Hole



Pigeon Hole

FEATURES

- Two height options
- Dividers come as standard
- Modular all steel construction
- Powder coat finish
- Holds both A4 & foolscap
- Aesthetic design
- All panels replaceable
- Stock Colour: Pearl White – Grey

SPECIFICATIONS

Product	Height	Width	Depth
Profile Full Height Pigeon 40 Hole Unit	1800	1008	386
Profile Half Height Pigeon 20 Hole Unit	900	1008	386

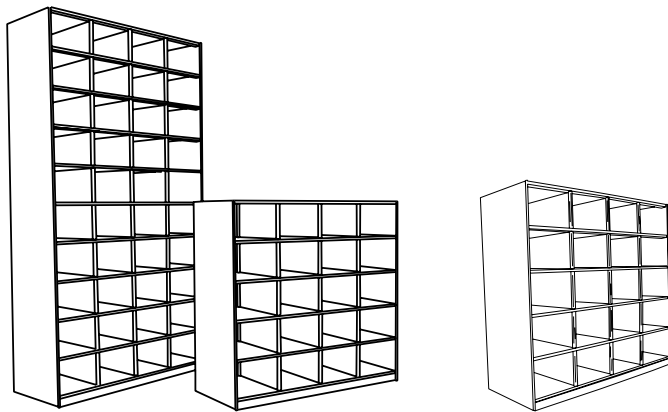

WARRANTY & CHAIN OF CUSTODY

PCF Australia is committed to product stewardship. We will undertake recycling of PCF Australia products at the end of the products life. The only cost is the freight to PCF Australia.

- 5 Year Warranty
- Covers material and workmanship
- Does not cover misuse or abuse