

www.aspeninteriors.com.au

Armidale 65 Seaton Street Armidale NSW 2350 P. 02 6776 6100 E. armidalesales@aspeninteriors.com.au
Sydney 53 Holbeche Road Arndell Park NSW 2148 P. 02 9622 0046 E. sydneysales@aspeninteriors.com.au

altitude
[SYSTEMS FOR COMMERCIAL TABLES]



altitude

[EASY TO FIND YOUR COMMERCIAL TABLE SOLUTION]

MENU	
Executive Tables	
Polo	4
Wedge	6
Jupiter	8
Saturn	10
Arrow	12
Mercury	14
Folio	16
Task Tables	18
Gallery Collection	
Coffee Tables	20
Gallery Collection	
Training Tables	22
Gallery Collection	
Folding Tables	26
Gallery Collection	
Power and Data Table Options	28
Table Options	30
Tables and Seating	
Edge Profiles	
Legs	
Boardroom Collection	34

Executive Polo



The combination of contrasting materials gives this table its instant appeal. The polished die-cast aluminium base aspect creates an infusion of modernity and sophistication. **Polo** suits an endless variety of table sizes. The flexibility of segmented base construction means you can have it built to suit your desired look and budget.

Executive Wedge



Wedge is an innovative table with a unique profile. Its geometric shaped base evokes a state-of-art aesthetic for the meeting room. The heavy duty aluminium structure supports an unlimited size, melamine, veneer or polyurethane top, with minimal components for easy dismantle.

Executive Jupiter



Jupiter is a collection for the upmarket office. Its simplistic beam design lends itself to a very architectural, advanced look. Jupiter's unique design takes the beam concept further with its integral cable management function. The deep structural beam allows for generous cable storage. Effortless to adapt, move or reconfigure, the Jupiter table is the complete solution for individuality in the office.

Executive Saturn



Saturn is a bespoke style for the office. It creates an ambience that goes beyond its façade. Featuring a highly durable steel beam base structure, Saturn is available in numerous lengths with a range of table top finishes, from veneer boat shape with a leather or vinyl inlay to a melamine D-end.

Executive Arrow



Arrow generates a gasp of appreciation by provoking wow factor in the office. The defined engineering and high quality structure characterises Arrow. This is supported by a finished polished steel and powdercoated base structure that allows modularity and long spans to suit the table top size and finish you require.

Executive Mercury



Mercury tables reap the rewards combining an elegant aesthetic with an ability to respond to specific user needs. Options include; stand alone, folding or a transportable base. Mercury allows for uniformity of style throughout the workplace from meeting rooms, training rooms through to breakout areas of the office.



Executive Folio



Folio evokes timeless elements of nature and warmth to the office. With strong, clean lines of woodgrain in natural veneer or timber grain melamine, Folio is available in a wide range of finishes. Solid construction and superior craftsmanship makes Folio the ideal table for the discerning executive.



Task Table Gallery



Focus Range



Friz Range



Orbit Range



Trumpet Range



Form Range



Index Range



Wilks Range



Echo Range



Folio Range



Erin Range



Venus Range



Edge Range



Cloverleaf Range



Equator Range



Twist Range



Task tables are a collection of tables manufactured to provide a mix and match style for a variety of work environments. The Task table range is designed for you to be able to simply choose from a palette of top shapes, finishes, edge details, and a selection of bases to create the perfect solution for any application specifically suited to your own requirements.



Coffee Table Gallery



Maggie Range



Drum Range



Trumpet Mini Range



Friz Mini Range



Barrel Range



Kross Range



Uno Range



Pixi Range



Cube Range



Autumn Range



Core Mini Range



Maxi Range



This coffee table collection is designed for you to simply choose from an array of styles, top shapes, finishes, sizes and edge details to create diverse structures suitable both for smart offices and prestigious meeting areas suited to your own requirements.



ASPEN

Training Function



Space



Stik

Function tables are an extensive collection suited to a training environment. Each design achieves a simplistic yet vivid aesthetic and are functional and flexible to suit every requirement.



Fan



Siren

Training Function



Quadrangle



Trapezium



Triangle

Training tables are designed with simplicity in mind. An innovative multi-use solution that can be easily reconfigured to maximise office space and suit your changing requirements.



Folding Form



Zone



Lava



Flex

Folding Form tables offer a robust selection of folding table systems in a variety of styles and arrangements. Systems that can be quickly unfolded, re-arranged, stacked and stored. The tilting action allows tables to nest together for easy storage when not in use. Whether you require a big conference table, a modular breakout table or a mobile training table these tables allow optimal flexibility for any user with rapid area reconfiguration; saving time and office space.



Click



Bendz





Power & Data Gallery

To further enhance your office ergonomics, each of these power and data systems are fully compatible with every table design. Each module can be configured to suit all applications, with a variety of Data & GPO sizes. In addition to this you can also have all Data or an all GPO facility.





	Power & Data Model	GPO Supplied	Data Supplied	
	Omega		2	2
			4	4
			6	6
			8	8

	Power & Data Model	GPO Supplied	Data Supplied	
	Fuel		4	3
			4	8
			4	5
			4	6

	Power & Data Model	GPO Supplied	Data Supplied	
	Cork		2	0
			3	0
			4	0
			2	2
		4	4	

	Power & Data Model	GPO Supplied	Data Supplied	
	Alpha		2	2
			3	0
			3	2
			4	2
		4	4	

	Power & Data Model	GPO Supplied	Data Supplied	
	Vertical Power Tower		2	2
			3	3
			3	0
			4	2
		4	4	

	Power & Data Model	GPO Supplied	Data Supplied	
	In Built Cable Flap		2	2
			4	4
			6	6
			8	8

Circle

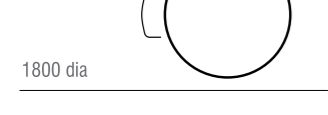
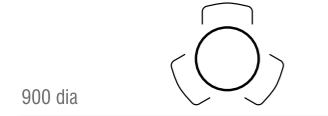

Wave



Triangle



Oval

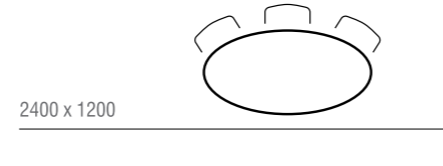
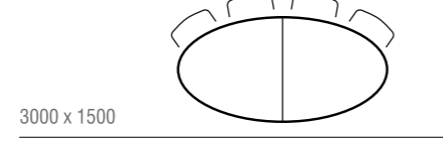
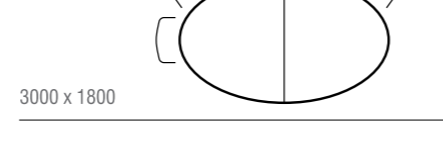
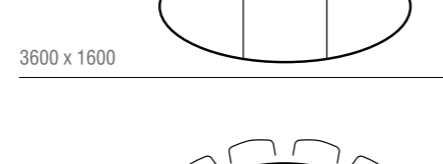
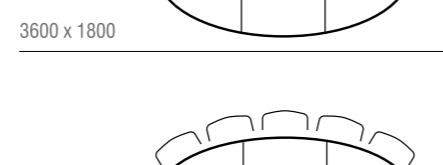
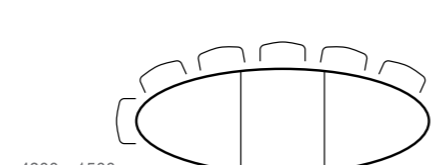
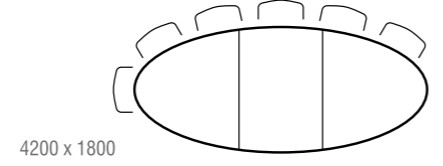

D End

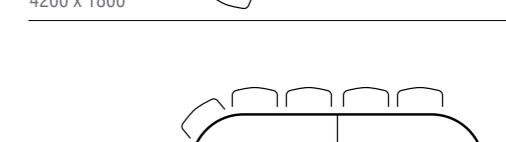
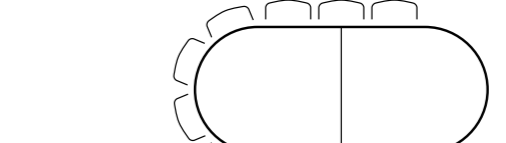
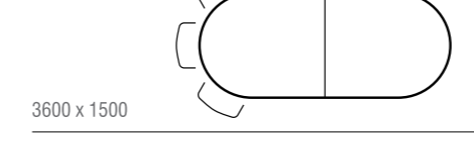
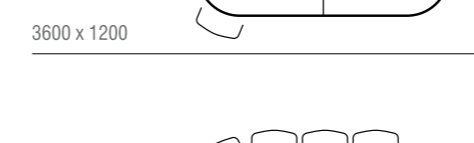
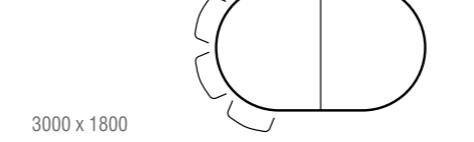
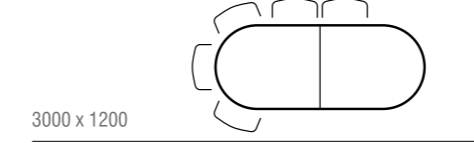

Boat Shape

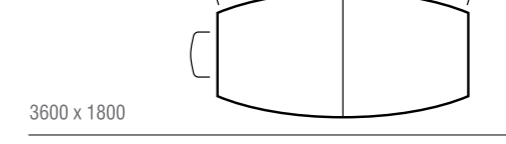
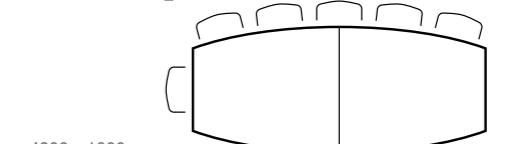

Important: Chair placement is an indication only. The number of chairs varies according to chair size and leg options.

Tables and Seating

Characteristics to be considered when specifying a table include: Top shape and finish; table edge details; leg type, number and finish; chair size and type.

Rectangle

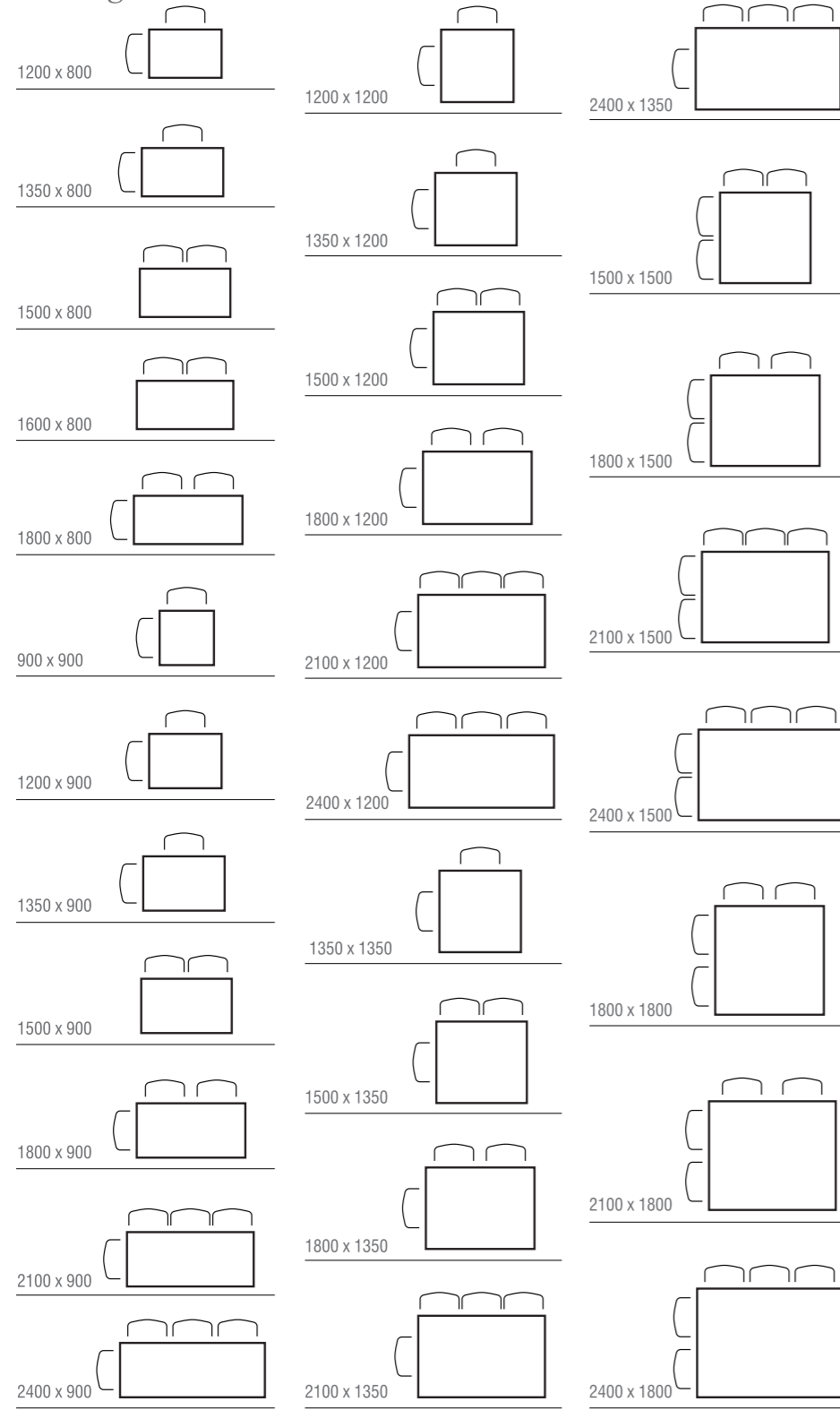

Trapezoid

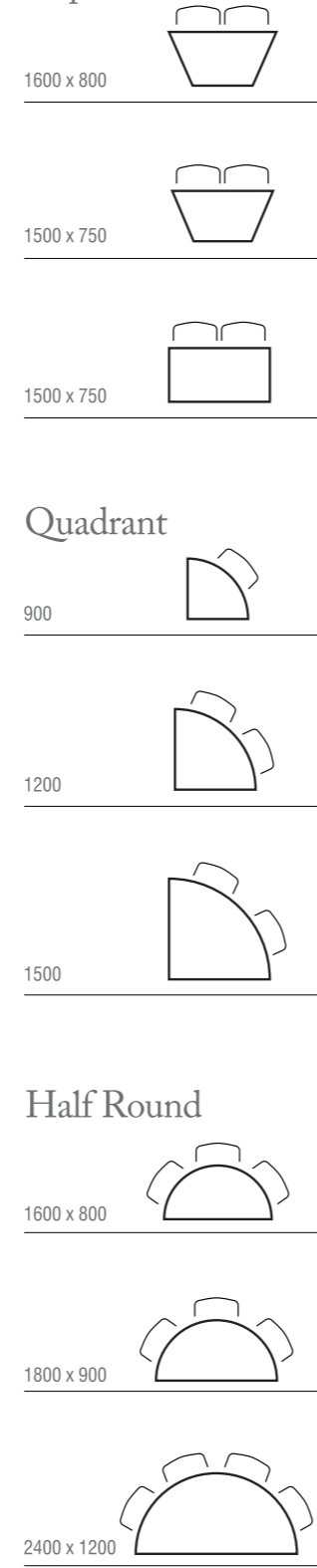

Quadrant

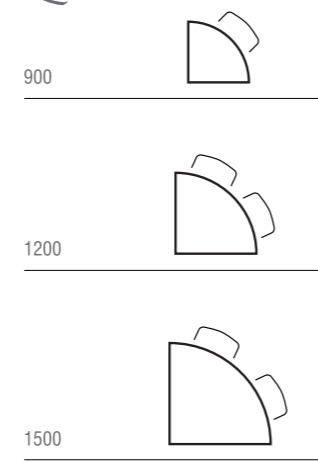

Half Round

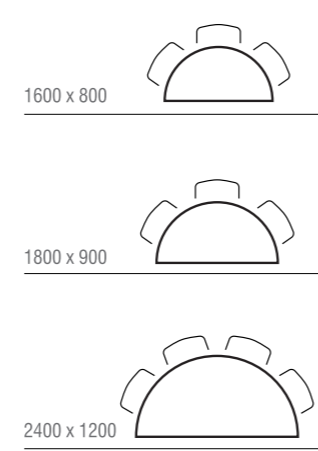

Edge Profiles

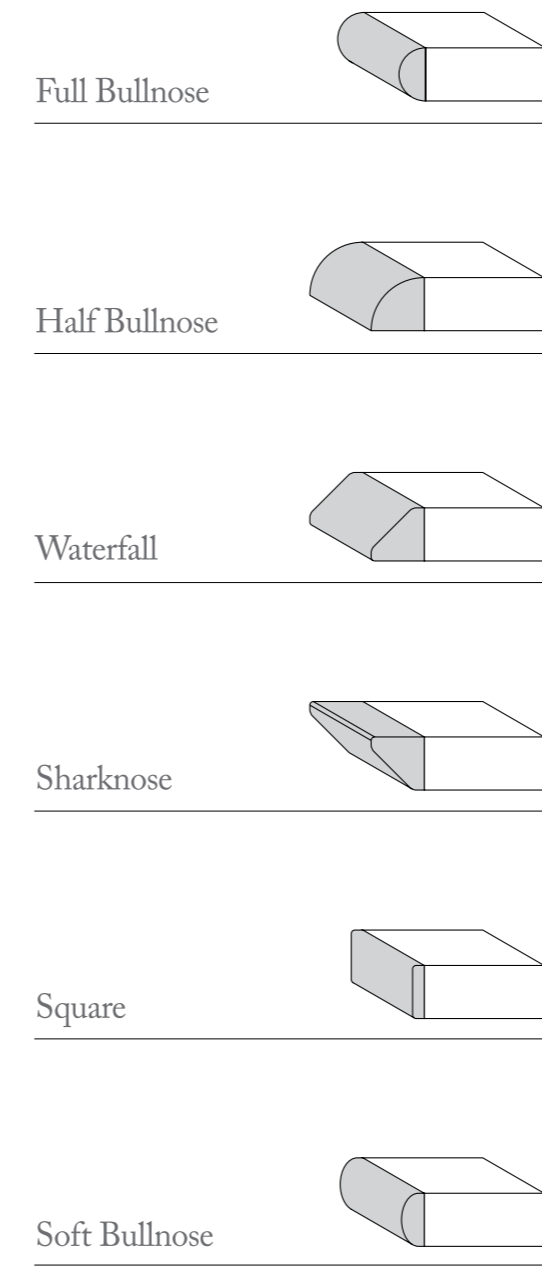

Legs

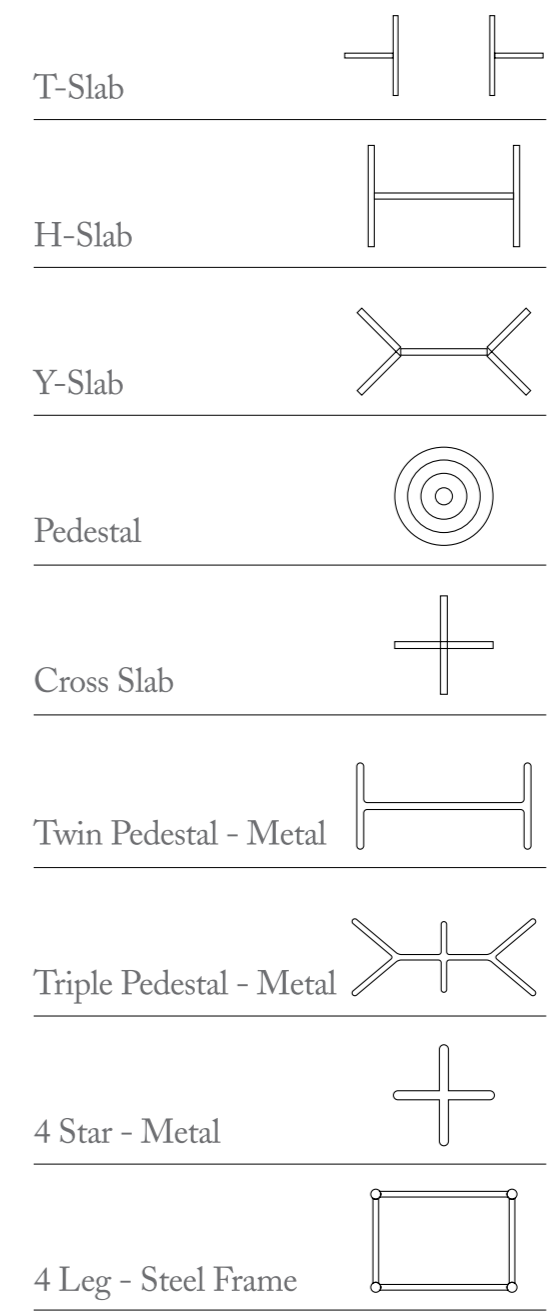

Tables and Seating

Characteristics to be considered when specifying a table include: Top shape and finish; table edge details; leg type, number and finish; chair size and type.



Boardroom Collection

The Boardroom Collection portrays evidence of the range of custom designed boardrooms that Aspen Interiors can accomplish. Versatile office furniture systems range from boardroom tables and wall units to boardroom servery units, custom designed to give you superior quality and the successful edge you are looking to achieve for your company.

