

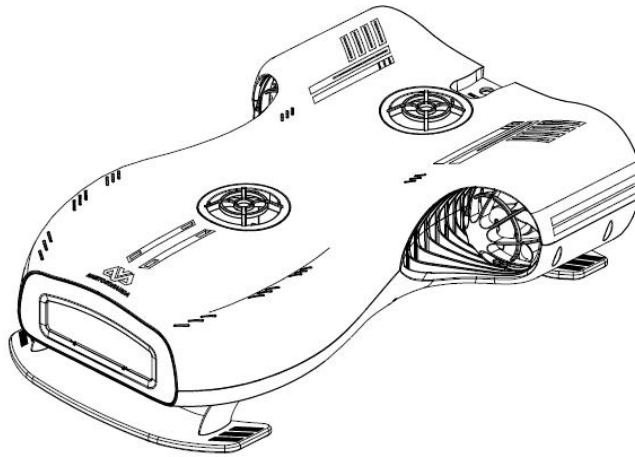

# NEMO

User Manual V2.0



## Reading Suggestions

### Recommendations

Users are advised to watch the video tutorial and read the DISCLAIMER before reading this manual.

### Video Tutorial

Users can view the video tutorial via the link below to learn how to use the product correctly and safely.

[http://bit.ly/Nemo\\_YouTube\\_Aquarobotman](http://bit.ly/Nemo_YouTube_Aquarobotman)

### Download the Aquarobotman App

Users can download the "Aquarobotman" App directly from the App store, or download it from our official website: <https://aquarobotman.com/pages/app-download-1>

Notes: The App must be used together with Nemo underwater drone.

## 目录

Reading Suggestions.....	2
Recommendations.....	2
Video Tutorial.....	2
Download the Aquarobotman App.....	2
Product Overview.....	5
Introduction.....	5
Features.....	5
Modules Composition.....	5
Dynamic System.....	8
Lighting System.....	8
Underwater drone Functions.....	8
Smart Battery.....	9
Wi-Fi base station.....	10
Introduction.....	10
KEVLAR Signal Cable.....	10
Wi-Fi Signal.....	10
Protection System.....	10
Aquarobotman App.....	11
Introduction.....	11
Main Interface.....	11
Setting Interface.....	13
VR Interface.....	14
Help Interface.....	14
Preview Interface.....	14
Operation Guide.....	15
Installation.....	15
App Operation.....	15
Controller Operation.....	21

---

VR Control.....	22
Video Download.....	24
Sensor Calibration.....	29
Battery Charging.....	30
Backpack Usage.....	30
Precautions.....	31
Usage Environment Requirements.....	31
Examination before Usage.....	31
Post-use Maintenance.....	31
Media Data Export.....	31
Appendix.....	33
Specifications.....	33
After-sales and service warranty Information.....	35
Product return and exchange policy.....	35
Warranty policy.....	36

## Product Overview

The functions and features of Nemo drone and names of the various modules will be introduced in this section.

### Introduction

The Nemo underwater drone is equipped with 4K UHD camera and 4-duct stabilization system, making it capable of shooting real-time, stabilized underwater footage of high definition. It can travel at up to 2m/s underwater and continue to operate for 3 hours. The modular design makes the Nemo drone easy to carry with and extends its battery life much longer.

### Features

- 1. High Resolution 4K Lens.** Nemo drone supports up to 4K video shooting and 16-megapixel photography. The video recording can be up to 120 frames per second. Together with QAS-Balance system, Nemo drone makes it possible to capture dynamic pictures of high quality.
- 2. QAS- Balance System.** The 4-thruster design and the independently developed control system allow the Nemo to travel underwater with great stability to take stable videos and photos.
- 3. Detachable Battery Design.** The drone battery is removable; the twist cap on the outer casing of the Nemo drone opens the battery compartment. The drone battery can be replaced with another one when it runs out of power. The battery for the Reel with Wi-Fi Base Station can be replaced also independently.
- 4. Multiple Experience Methods.** Multiple operating methods are available including using the mobile App, VR headsets and game controllers. The app control interface is easy to learn and use. Under VR somatosensory mode, the game controllers can be used simultaneously with VR headsets to control the drone. Except to be controlled by the controllers, the drone will also move in sync with the head movements under VR, to obtain a realistic experience.

### Modules Composition

The component modules will be introduced and described in this section. For details on the specifications and parameters, please check the specification table in the appendix.

1. Main unit

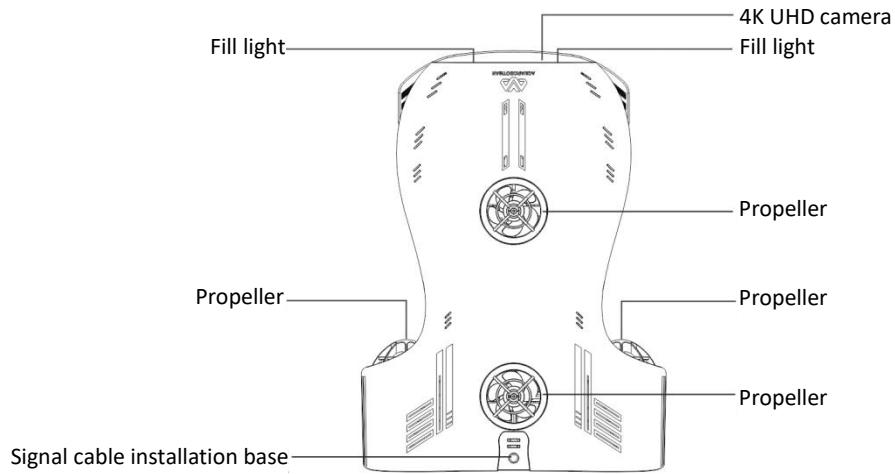

The front

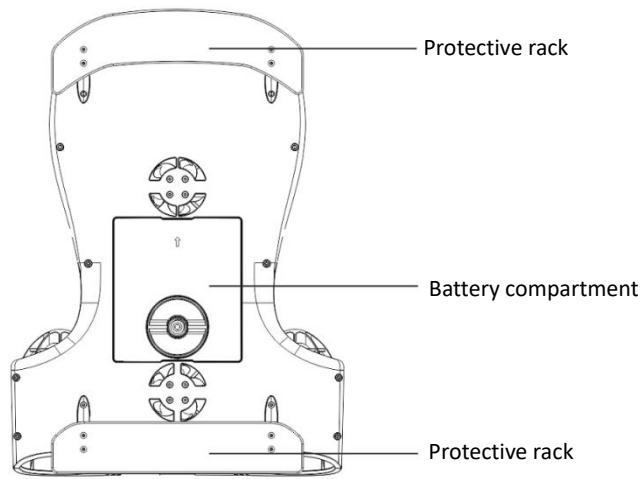

The back

## 2. Nemo battery

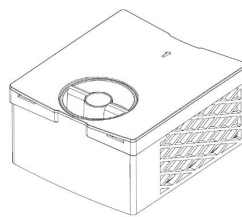

## 3. Wi-Fi base station

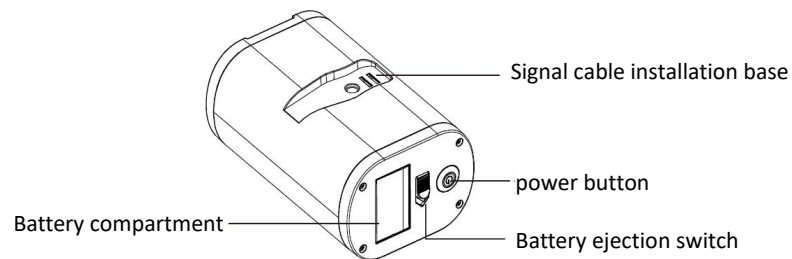

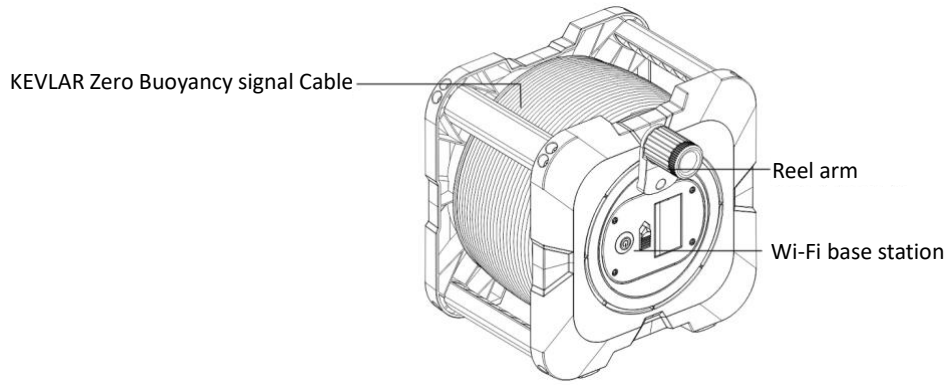

#### 4. Wi-Fi base station battery

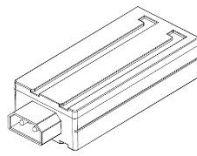

#### 5. Nemo charger

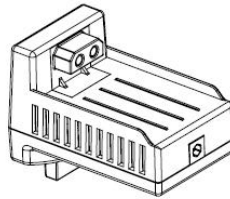

#### 6. Filter

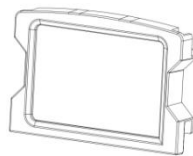

#### 7. Protective rack

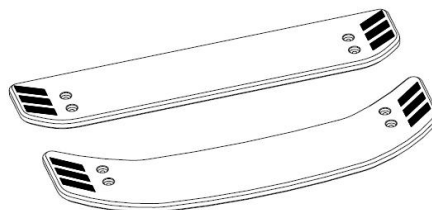

## Dynamic System

The dynamic system of the drone is mainly formed by a 4-duct propeller system which is composed of 2 horizontal + 2 vertical propellers, provides the drone with power needed for underwater movements and makes it flexible for various maneuvers of submerging, floating, moving forwards or backwards and steering. The propeller consists of motor and propeller blades. With anti-corrosive motors of customized professional waterproof and self- designed propeller blades, the performance of the motor is increased to its maximum potential.

## Lighting System

The underwater drone adopts adjustable matrix low beam fill lights with a maximum brightness of 1000lm to ensure high-quality pictures taken in a dim environment.

Suggestions: in the case of noon, sunny day or other scenarios when there is adequate illumination, the light can be turned off to save battery. At night or in caves and deep waters where the illumination is weak, the fill light should be turned on.

## Underwater drone Functions

- 1. Depth Hold:** under normal circumstances, the drone can be controlled and move in horizontal direction with its current depth and pitch angle unchanged.  
Notes: this function relies on the drone's internal sensors. In some complex scenarios, such as when there is strong magnetic field interference, the drone will be unable to operate regularly. In such situations please leave the area to a safe place to use it.
- 2. Direction Hold:** under normal circumstances, the drone can be controlled to submerge or float through snorkeling throttle controller with its current fuselage direction unchanged.
- 3. The omnidirectional operation:** this mode supports a multiple control mode and enables complex maneuvers such as tilting upwards or downwards at large angles. This mode restricts the tilt angle of to  $\pm 45^\circ$  and the speed of tilting is different under different speed level.
- 4. VR somatosensory operation:** VR somatosensory control is supported, users can change the perspective of the drone through head movements for immersive experience.
- 5. Smart Protection System:** The built-in protection system can trigger corresponding protection for the drone in case of unexpected abnormal situations during usage, to protect the drone from damage. The service life of the drone shall be greatly extended.
  - 1) Temperature protection:** the normal operating temperature of the drone is  $-2^\circ\text{C}$ - $35^\circ\text{C}$ . If the drone detects an abnormal internal temperature, it will enter a protective state.  
Two main reasons for abnormality:
    - a) Operating in high temperature waters.
    - b) The drone was turned on and exposed in the air for long time, and the internal temperature of the drone got too high.
  - 2) Humidity protection:** when the drone detects too much humidity, it will take protective measures.



Situation above shall not be found under normal operation. If it happens then the underwater drone needs to be returned for repair.

Two main reasons for water seepage:

- a) Dive to depth of more than 100 meters underwater.
  - b) The internal seal of the drone is broken or damaged.
- 3) **Over-current protection:** the protective measures can be triggered when the internal current is too high.

Two main cases for abnormality:

- a) Propeller is entangled and cannot rotate.
  - b) Internal failure of the drone causes short-circuit.
- 4) **Low voltage protection:** this protective feature will be triggered when the battery voltage falls too low. When the voltage falls below 10%, there will be a notification on the app, and when the voltage drops to 0%, the battery will automatically shut down and the underwater drone will be unable to move. When this happens, the KAVLAR zero buoyancy cable can be used manually to pull the drone back to the surface.
- 5) **Motor protection:** when the drone is unlocked and no control is performed, if the drone pitch or roll angles is greater than 60 degrees, the motor will stop and enter a protection mode until both angles are less than 60 degrees.

## Smart Battery

As a standalone component, the drone battery has a built-in smart control to ensure safety. The battery has the following features:

1. **Load detection:** before loading, the battery will be in sleep mode and will not discharge. Working only begins after the battery has been connected to the underwater drone.
2. **Battery self-checking:** with battery installed, the drone will firstly do a self-check on the battery level to see whether the power meets the boot requirement.
3. **Battery short-circuit protection:** when the battery detects short-circuit, the output will be cutoff to protect the battery.
4. **Over-current discharge protection:** when there is an over-current during discharge, the output will be cutoff to protect the battery and external circuits.
5. **Battery storage:** the battery can be stored short-term in any state. For long-term storage, please refer to the User Manual of battery.

## Wi-Fi base station

This section introduces Wi-Fi base station, which works as a communication hub between the underwater drone and the user terminal.

### Introduction

The Wi-Fi Base Station is a hub for communication between underwater drone and the user terminal. It consists of four parts including KEVLAR signal cable, battery, base station and reel. The battery is detachable and of high capacity. Built-in Wi-Fi signal transmitter works to connect user's mobile, transmit the feedback signal of the drone and the control signal from the mobile App in real time, users can view the status of the drone and control it through their mobile.

### KEVLAR Signal Cable

The KEVLAR cable's main function is for signal transmission. The cable has built-in reinforced KEVLAR fiber and can withstand a maximum of 100kg of pulling force, also a safety rope under emergency. The cable shows neutral buoyancy in freshwater and positive buoyancy in seawater.

### Wi-Fi Signal

The 802.11a standard Wi-Fi is used, and the communication range is 50m in open areas.

### Protection System

When the battery voltage is too low, the system will automatically cut off the power to protect the Wi-Fi base station battery.

# Aquarobotman App

App interface and usage instructions will be introduced in this section .

## Introduction

The Aquarobotman App is developed to work with Nemo drone to control its movements, setup the basic camera parameters and check the status of Nemo drone. It can also be used to share photos and videos to social networks.

## Main Interface

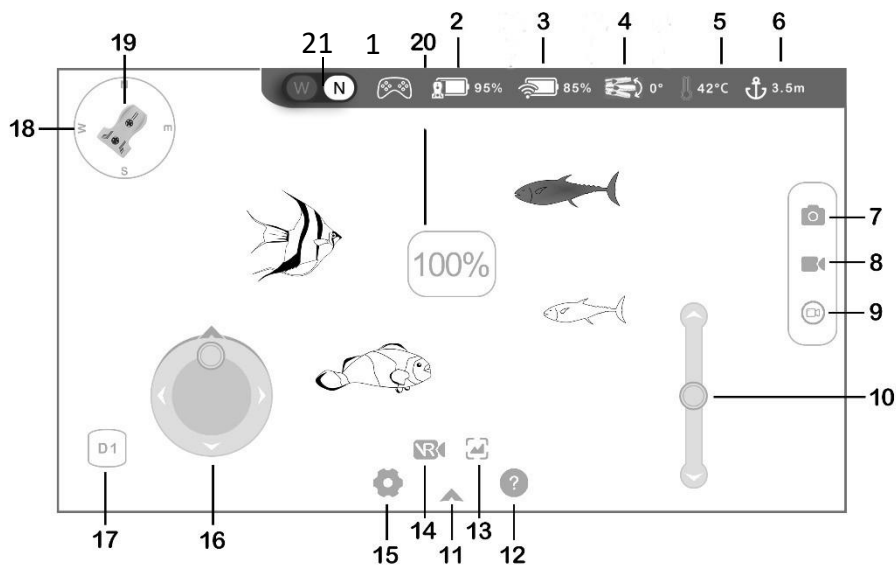

### 1. Controller connection status

: indicates the controller's connection status. A red icon with "x" means connection failure, a white icon and a blue "V" means connection success, and a white icon means normal operation.

### 2. Underwater drone battery level

: battery level is shown in percentage. The icon will turn red when the battery level is low, there will be a pop-up notification.

### 3. Wi-Fi Base Station battery level

: when the Wi-Fi Base Station battery level is low, the icon will turn red and there will be a pop-up notification.

### 4. Underwater drone pitch angle

: real-time display of underwater drone pitch angle data.

### 5. Underwater drone working temperature

: indicates the underwater drone's internal operating temperature instead of the water temperature.

### 6. Current water depth

: indicates the current water depth of the underwater drone in meters.

### 7. Camera shutter button

: takes a single photo.

#### 8. Long video button

: starts taking a long video, the button will turn red and the time can be seen on the left side of the button. While taking the video, pressing the button again will end the video and the button will turn white again.

#### 9. Short video button

: press the button to start a short video which is 20-second long, and the red circle shows the time recorded. The short video recording will be canceled if the button is pressed again before the video completed. the video will be automatically stored to local storage once completed to be readily shared at any time.

#### 10. Snorkeling throttle lever

: press on the middle dot area and slide up and down to make the underwater drone either float upwards or submerge downwards.

#### 11. Show/hide menu column

: expands the secondary menu which includes help page, playback, VR mode, and settings. Press again to hide.

#### 12. Help menu

: press help to display the function descriptions of the each button.

#### 13. Gallery preview

: preview all videos and photos taken by the underwater drone. Files can then be selected to be downloaded to local storage or deleted.

#### 14. VR mode

: enters VR mode where the interface splits into two screens, put your mobile into the VR headset for use.

#### 15. Settings

: provides related auxiliary settings including depth calibration, video resolution selection, version number, etc.

#### 16. Directional control panel

: the directorial control panel provides 360° omnidirectional control where the underwater drone can move in any direction horizontally.

#### 17. Quick toggle button

: to change the speed rate by sliding the button, the speed rate changed can be reflected by directional control panel.

#### 18. Hand-held compass direction

: displays the real-time direction of the mobile/tablet

#### 19. Direction of the underwater drone relative to the mobile

: indicates direction of the underwater drone relative to the mobile/tablet.

## 20. Lightning Control

 : Slide the screen left and right to control the fill light switch and adjust the brightness of the fill light.

## 21. Underwater Mode

: W is the underwater image mode, and N is the normal image mode. Different image modes affect the image quality of pictures, videos and documents transmitted, are applicable to different scenarios. The users can compare images quality under both modes and choose a better one for higher-quality shooting.

## Setting Interface

### 1. Sensor calibration

Horizontal calibration.

Place the underwater drone on a horizontal surface (floor, table or other horizontal surfaces) and click the depth calibration button for depth calibration. It takes 30 seconds.

Compass calibration.

After pressing the compass calibration button, rotate the underwater drone 360° in the space (vertical 360°, horizontal 360°, lateral reversal 360°) until the calibration completes. It takes 30 seconds.

### 2. Camera settings

Video resolution and camera settings can be configured here. For better experience more professional settings are provided including video resolution, image pixels, photo quality, video quality, consecutive mode, time-lapse, and video watermarking.

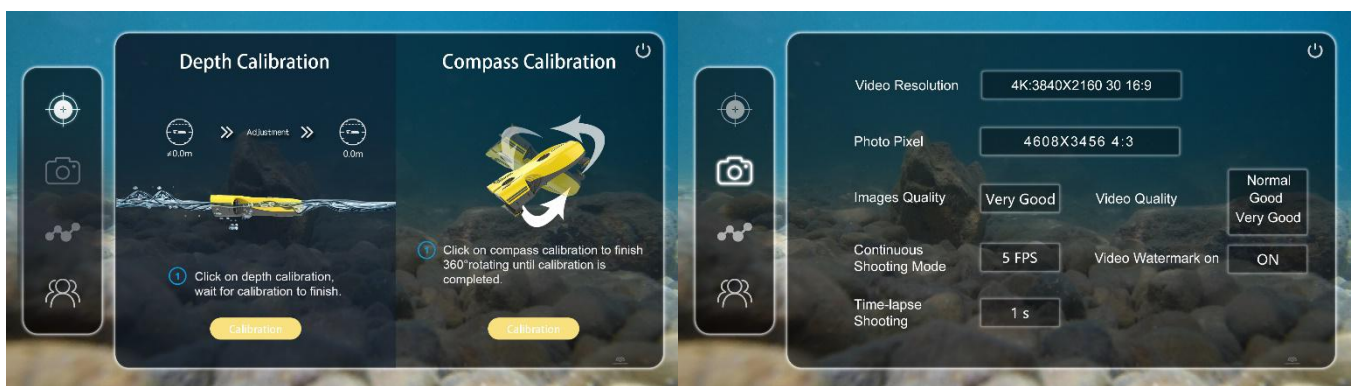

Calibration interface

Camera parameters

### 3. Status info

View current firmware version information. The drone's internal humidity will also be displayed, which can be used to detect whether there is any water leakage into the drone.

### 4. About us

To learn more, please visit us at our official website: <https://aquarobotman.com/>



Status info

About us

### VR Interface

Under VR mode the screen is presented in two parts. This mode supports somatosensory operation, which makes it easier for users with VR headsets to view underwater sceneries. The head position of users controls the drone's real-time viewing angle which brings a strong immersive experience.

### Help Interface

Functions of buttons on main interface.

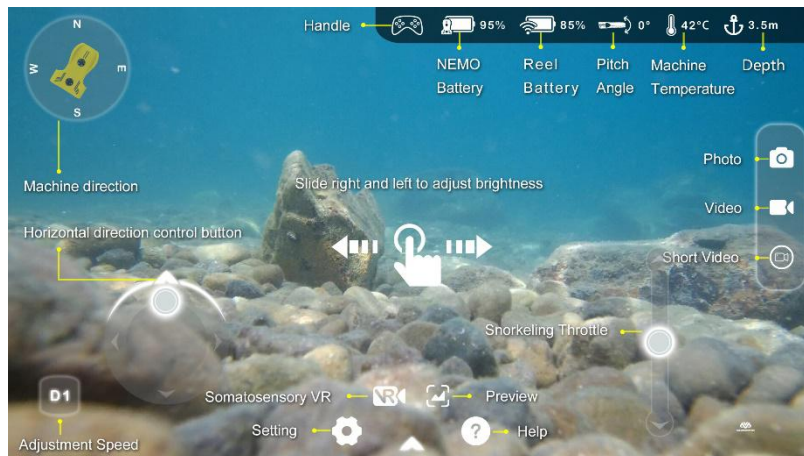

### Preview Interface

All photos and videos displayed here, can be downloaded or deleted.

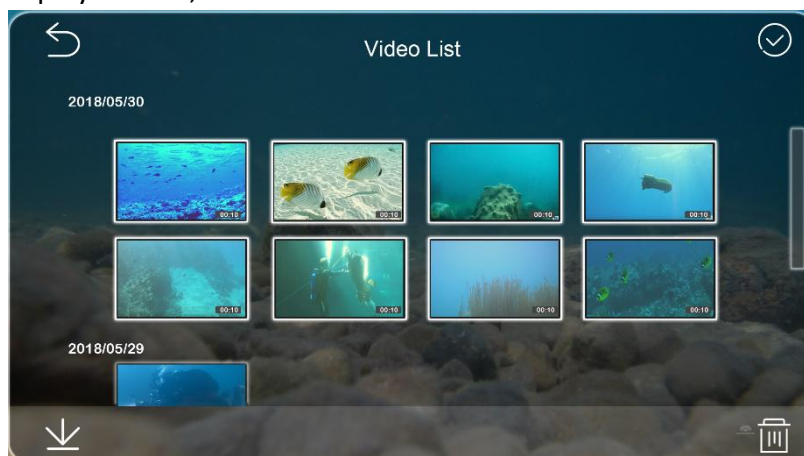

## Operation Guide

Detailed instructions for installation and operation.

### Installation

#### 1. Connect the drone

- a) Connect the KEVLAR cable with the tail section of the underwater drone.

Note: Poor connection at joint can result in poor contact and operation failure. Please make ensure that the joint contact is good.

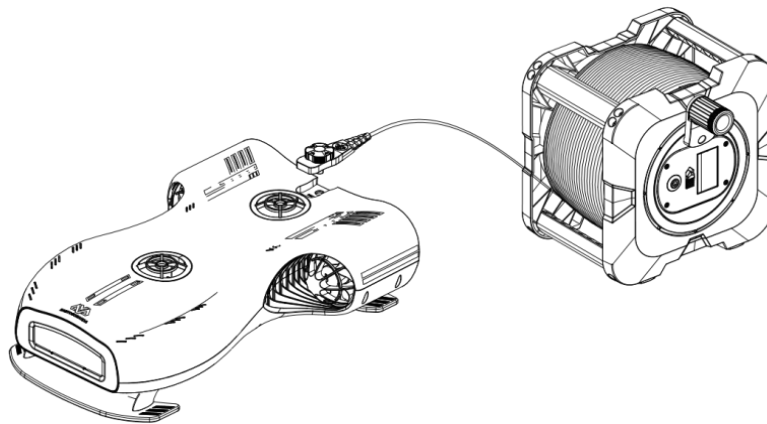

- b) Insert the battery into the underwater drone's battery compartment, then press on the battery slightly while turning the knob clockwise to secure the battery in place.

Notes: When the battery is installed successfully, there will be a prompt sound. However, the prompt sound is short and not too loud. If it is used outdoors, please listen carefully.

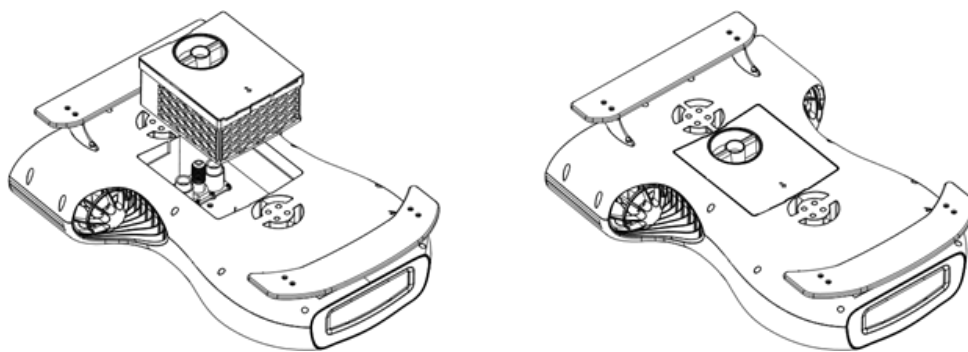

### App Operation

#### 1. Connect app

- a) Connect your device with the Base Station Wi-Fi. The Wi-Fi name is "Aquarobotman".

Notes: In the Wi-Fi list of your mobile or tablet, there will be two Wi-Fi networks including "Nemo\_XXXXXX" and "Aquarobotman\_XXXXXX". Make sure your mobile or tablet is connected to "Aquarobotman\_XXXXXX". If there is one WIFI: "Aquarobotman\_XXXXXX", it means the Nemo battery is not installed well, please install the battery and try again.

b) Open the App

After successful connection to the Wi-Fi base station, click on the App icon then it will be loaded on your device. All the icons in the prepare interface shall turn blue once the connection of battery and Wi-Fi station both succeeded, click on “YES” to enter. Prepare interfaces as below:



Notes: before opening the app, please confirm that the base station Wi-Fi is successfully connected as the APP does not support background operation. If the App is open without Wi-Fi connection, please exit the app and open it again, otherwise the App can't be loaded successfully.

c) App interface shows as below after successful connection

Notes : When the App is opened, the notice "video connecting" will appear on the interface for 10-60 seconds. When it disappears you will see the live feed with a warning tone, which indicates that the connection has been successful.

After successful connection, the icon of drone in the upper left of interface shows in yellow or gray, yellow indicates unlocked status, gray indicates locked status. Unlock operation is requested right after the warning tone each time for use, or the Nemo may not work normally.

In addition, the icon of game controller at the top of interface keeps being red, it will only turn white when it is under usage.



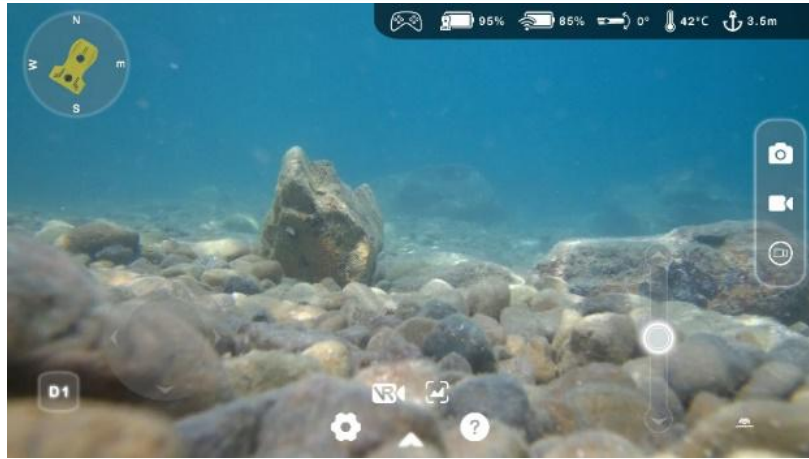

## 2. Operation

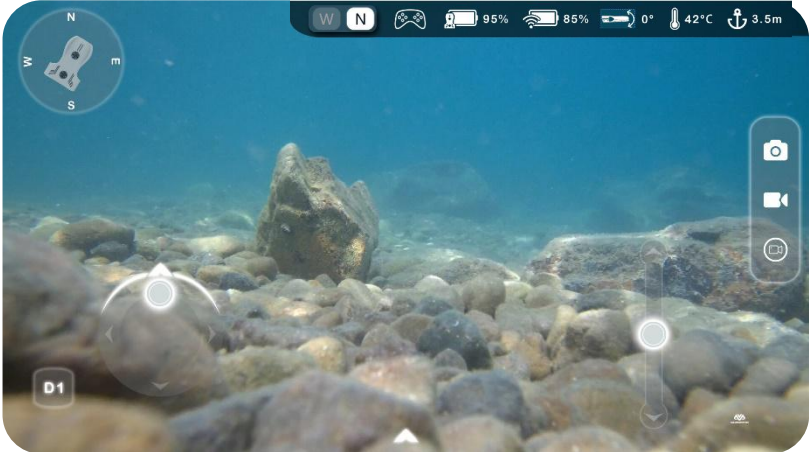
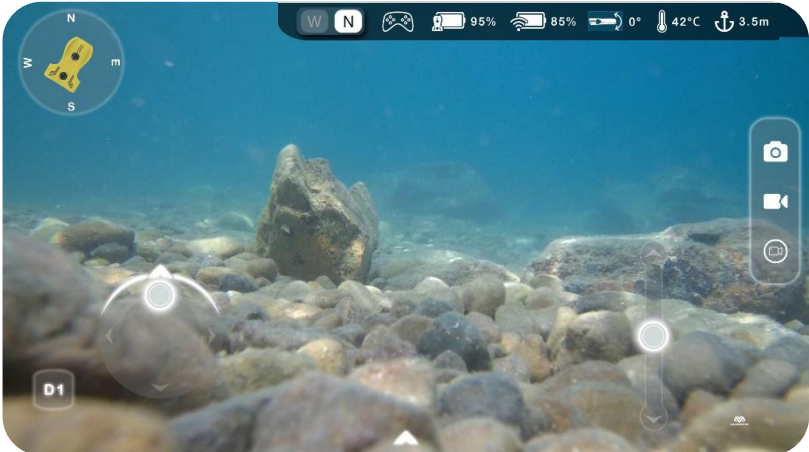
Functions	Illustration
<p><b>Lock</b></p> <p>If the icon in the upper left of screen is gray, this means that the underwater drone is locked and the propellers will not move</p>	
<p><b>Unlock</b></p> <p>If the icon in the upper left of screen is yellow, this means that the underwater drone is unlocked and the propellers should operate normally</p>	
<p><b>Fill Light Adjustment</b></p>	

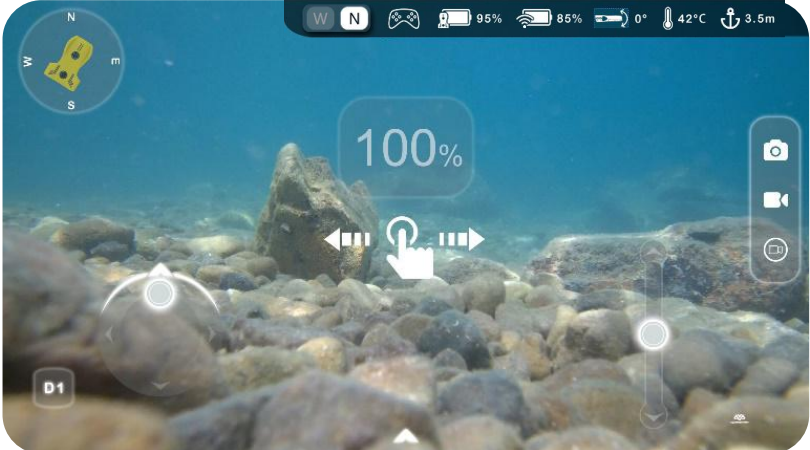
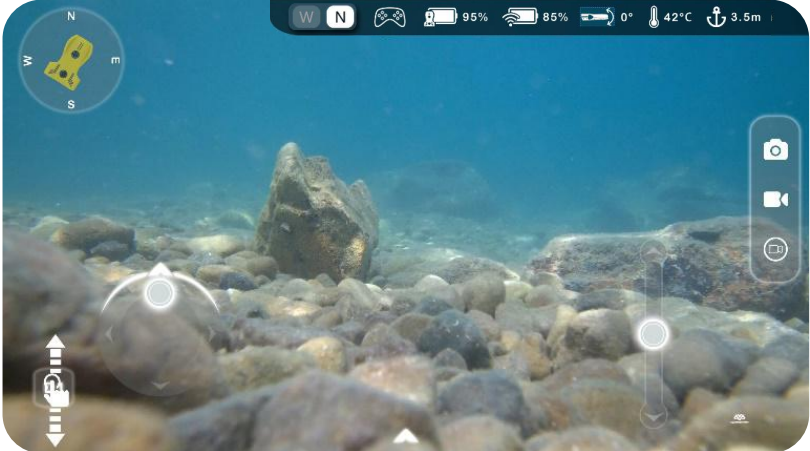
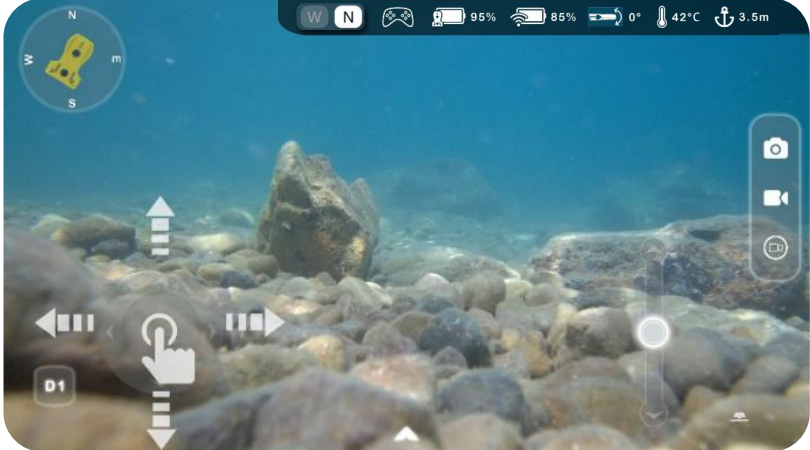
Functions	Illustration
<p>Slide rightwards or leftwards at the middle of the screen to adjust the brightness of the fill light</p>	
Speed Adjustment	
<p>Adjust the horizontal moving speed in three levels D1/D2/D3, together with the direction control D1 the slowest, D3 the fastest.</p>	
Horizontal Control	
<p>Controls the underwater drone's horizontal movement.</p>	
Snorkel Control	

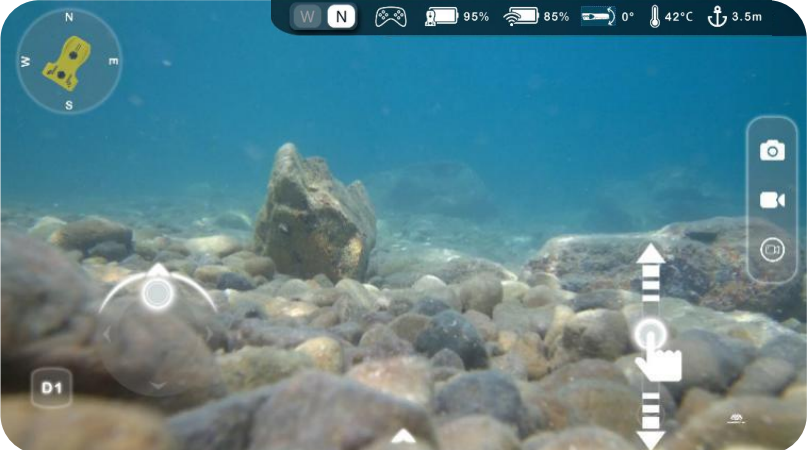
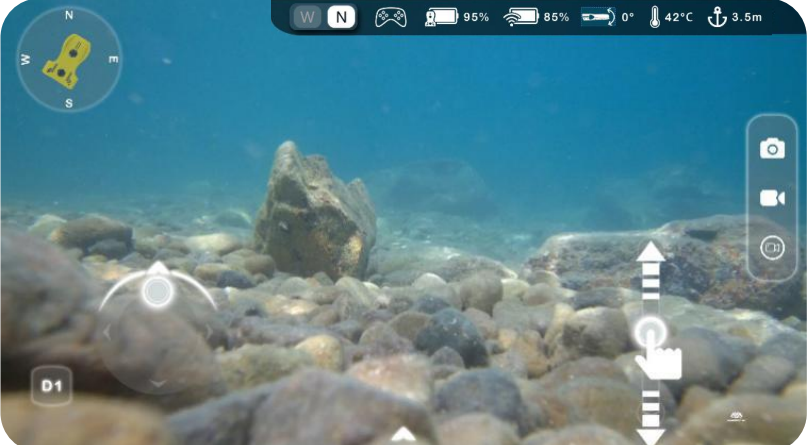
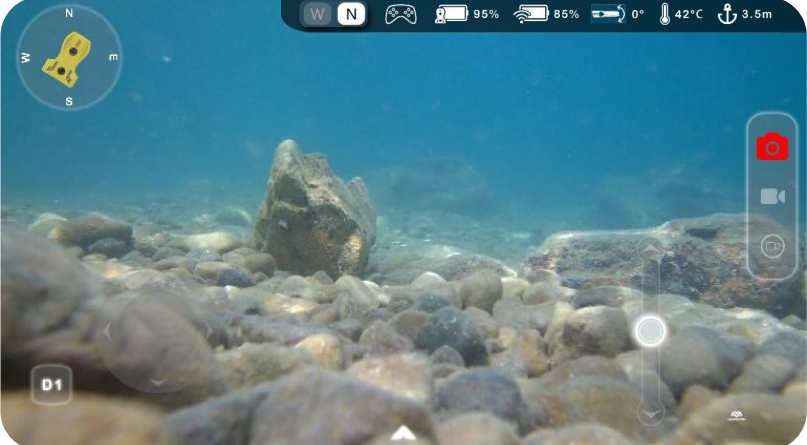
Functions	Illustration
<p>Controls the upwards and downwards movement of the underwater drone.</p>	 <p>The screenshot shows a first-person view from an underwater drone. At the top, there's a status bar with icons for Wi-Fi, North, a game controller, battery levels (95% and 85%), a temperature of 0°C, 42°C, and a depth of 3.5m. On the left, a circular compass shows cardinal directions (N, S, E, W) and a yellow drone icon. In the center, a white circular joystick is visible. On the right, a vertical slider with a hand icon is being used to control the drone's vertical movement. A camera icon is also present in the top right corner.</p>
<b>Omnidirectional control</b>	
<p>Simultaneous operation of the horizontal direction and snorkeling throttle allows the pitch angle to be changed while the drone goes forward, the maximum pitch angle is <math>\pm 45^\circ</math></p>	 <p>This screenshot is identical to the one above, showing the same control interface for the underwater drone with the vertical slider active.</p>
<b>Photo shooting</b>	
<p>The button will flash red and the screen will flash once when taking a photo.</p>	 <p>This screenshot is identical to the previous ones, but the camera icon in the top right corner is highlighted in red, indicating that a photo is being taken or about to be taken.</p>
<b>Long Video</b>	

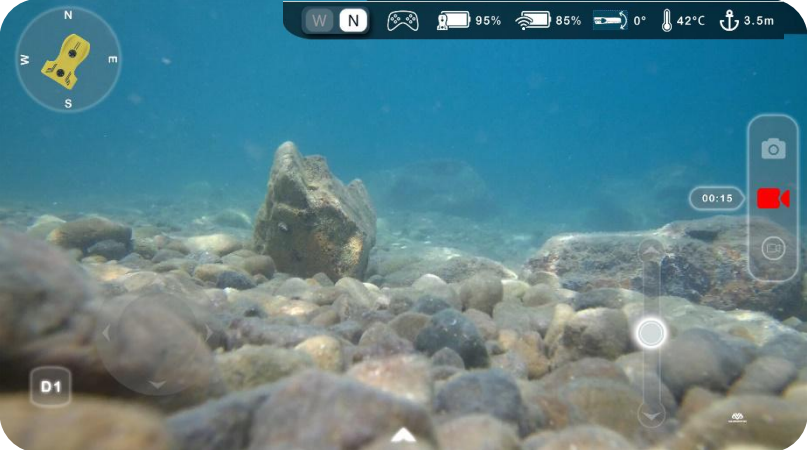
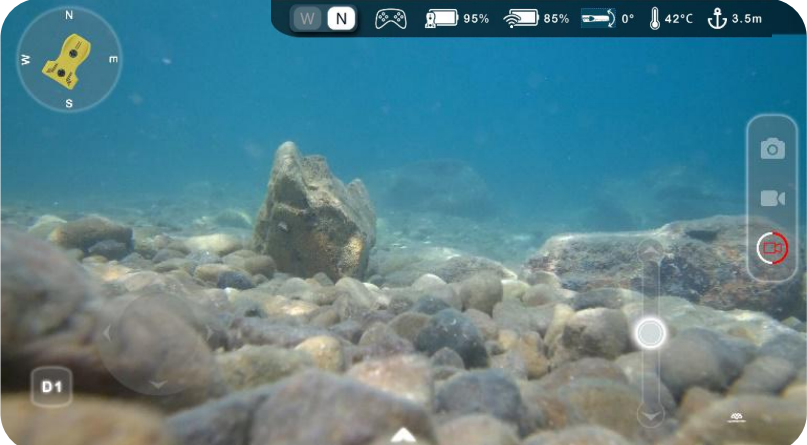
Functions	Illustration
<p>To record a long video of 5 minutes</p>	
Short Video	
<p>To record a short video of 20 seconds</p>	

### 3. Album management

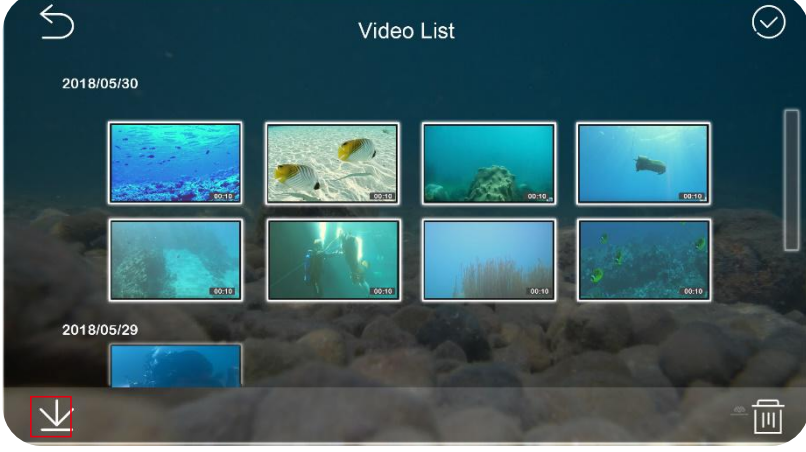
Functions	Illustration
<b>Gallery preview</b>	
<p>View and manage photos and videos taken</p>	
<b>Download</b>	
<p>One click to download selected videos or photos to local album for social sharing</p>	

### Controller Operation

1. Connection: controllers connect to the app via Bluetooth, there will be notice after connection. Users can control the drone on moving forward or backward, ascending, descending, photo taking, video recording, speed and fill light adjustment via controller just like the App.

Connection Steps :

- 1) Turn on the Bluetooth of controller.
- 2) Turn on the Bluetooth of your mobile
- 3) Find the controller Bluetooth in the Bluetooth list of your mobile and connect it, there will be a notice as " Controller Bluetooth connected".



2. Controller instructions: button functions are shown below:

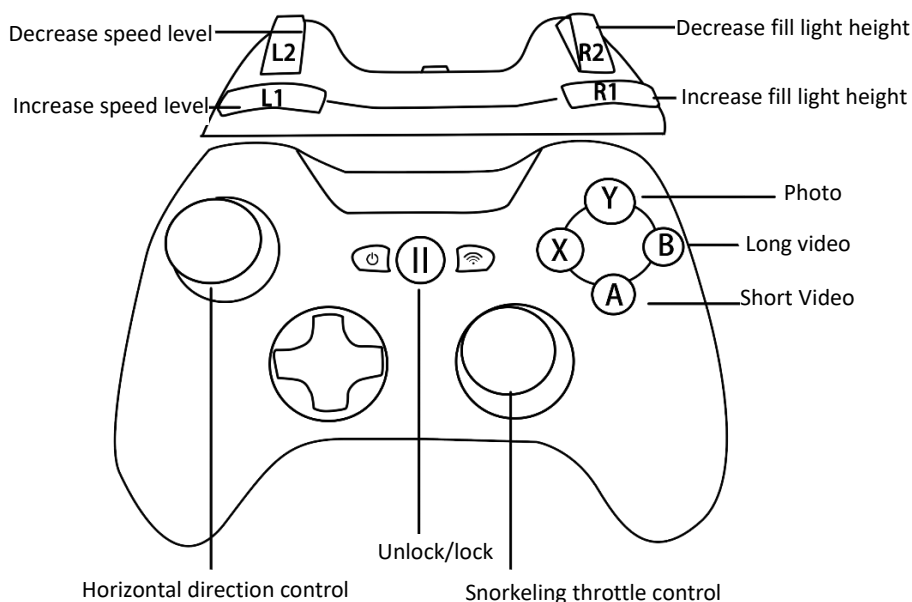

3. Controller can be purchased through Amazon, eBay, TMALL, JD. or other physical stores. The recommended controller brands are as follows:

iOS system: PXN

Android system: BETOP

## VR Control

In VR mode, users can change the perspective of the drone by adjusting the posture of the head. Under somatosensory control, the device can only change its pitch angle and turn left or right. Moving forward or backward, vertical diving or floating are not supported.

Proceed as follows:

1. Click the icon of VR at the bottom of interface to enter the VR mode, put your mobile into the VR box.

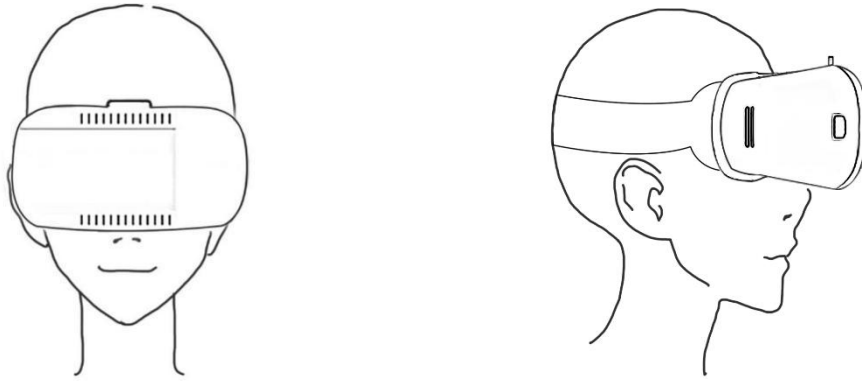

2. The device is locked after wearing the VR headset. Users need to unlock the somatosensory function first. Follow these steps to unlock:

a) Tilt head upwards 60 degrees or greater

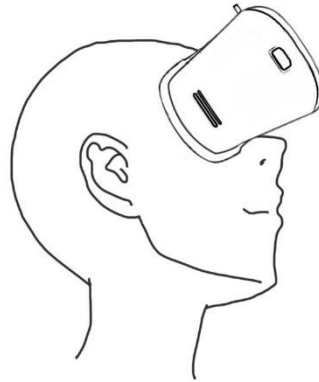

b) Tilt head downwards 60 degrees or greater

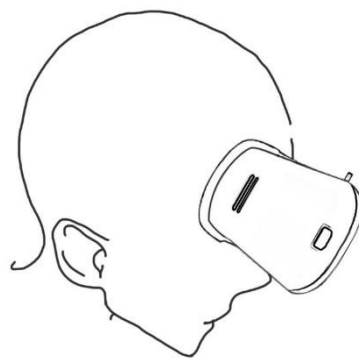

c) Return to original horizontal position

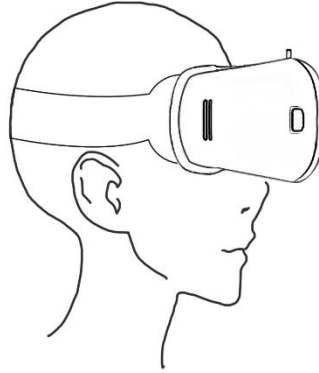

3. The somatosensory function shall be unlocked by following the steps above.

Notes: Movements can't be too fast during above operation, or it may result in failure. After unlocking successfully, we will have the live feed from the camera. The underwater drone's viewing angle can now be controlled by moving the head around. The two following directions are effected with somatosensory control.

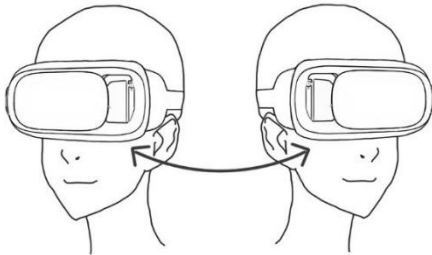

Shake head left and right

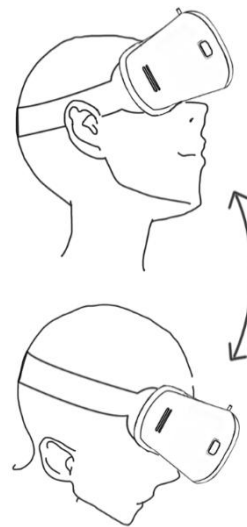

Tilt head up and down

4. VR headset can be purchased through Amazon, eBay, TMALL, JD. or other physical stores. Various brands of VR are supported.

## Video Download

Important Notes: the drone must be placed half in water when downloading videos, to avoid overheating.

Video can be downloaded by mobile and computer. Mobile downloaded images are defaulted in lower quality, for high-quality images please download with your computer.

Video can be downloaded from mobile and computer.

1. Download with mobile:

- 1) Connect the mobile to the base station Wi-Fi "Aquarobotman\_XXXXXX" or the Nemo Wi-Fi



“Nemo\_XXXXXX”.

- 2) Open App and enter the preview interface.
  - 3) Long press picture or video to download.
2. Download with computer, by Nemo Tools or browser:
- 1) Download with Nemo Tools
    - a) Download Nemo Tools from website: <https://www.aquarobotman.com/pages/app-download>
    - b) Install the file “Nemo Tools.exe”
    - c) Connect computer with base station Wi-Fi “aquarobotman\_xxx” or drone Wi-Fi “NEMO\_xxx”.
    - d) Start Nemo Tools, click the button “connect” to connect with Nemo, there will be a notice as “connect successfully” if the connection is succeeded.

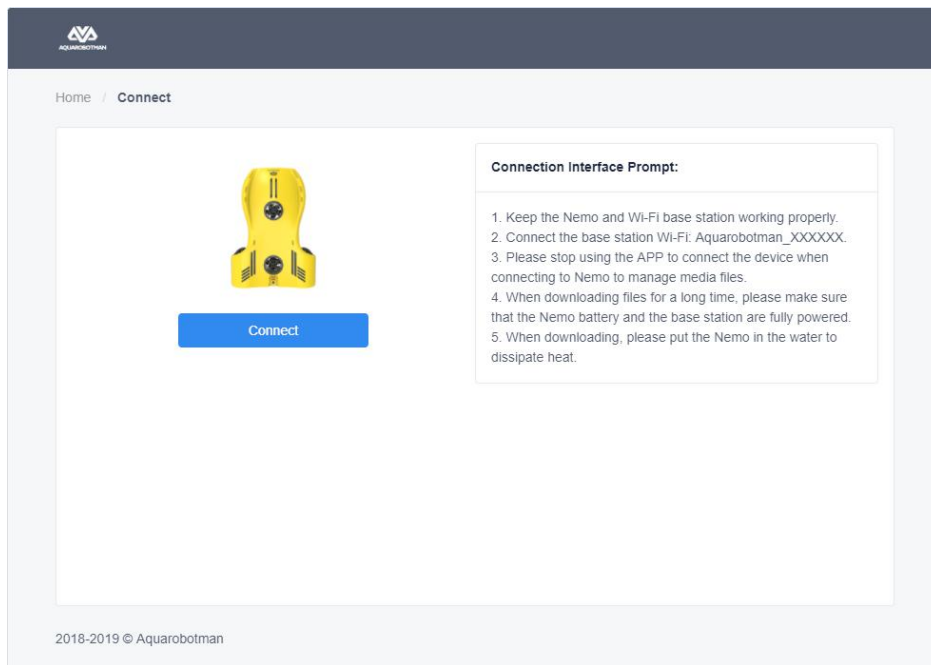

- e) Go to file list and it displays the current folders as shown below.

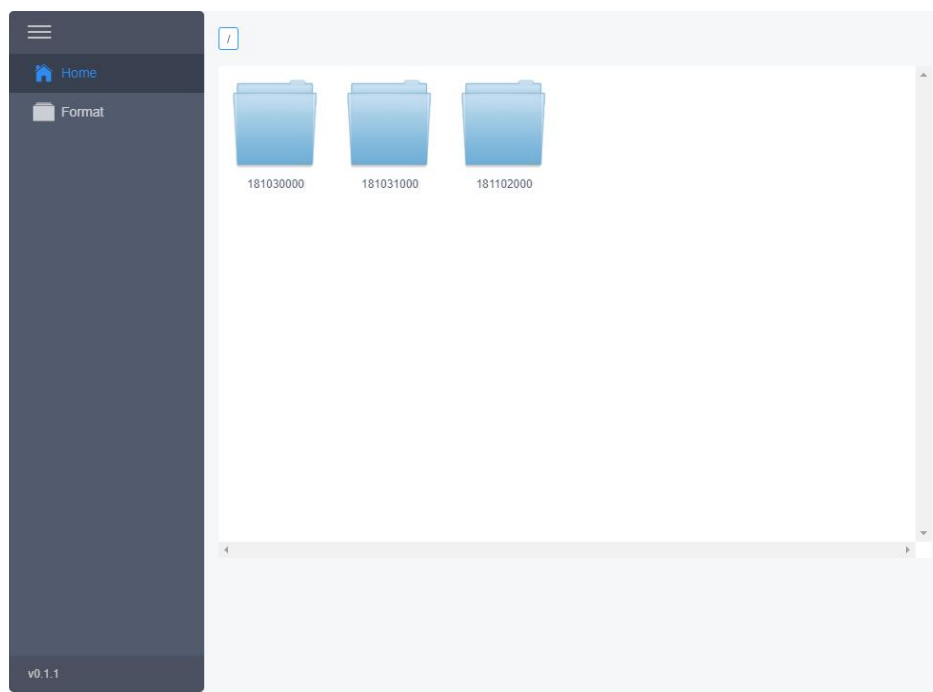

f) Click the folder to choose files to download or delete.

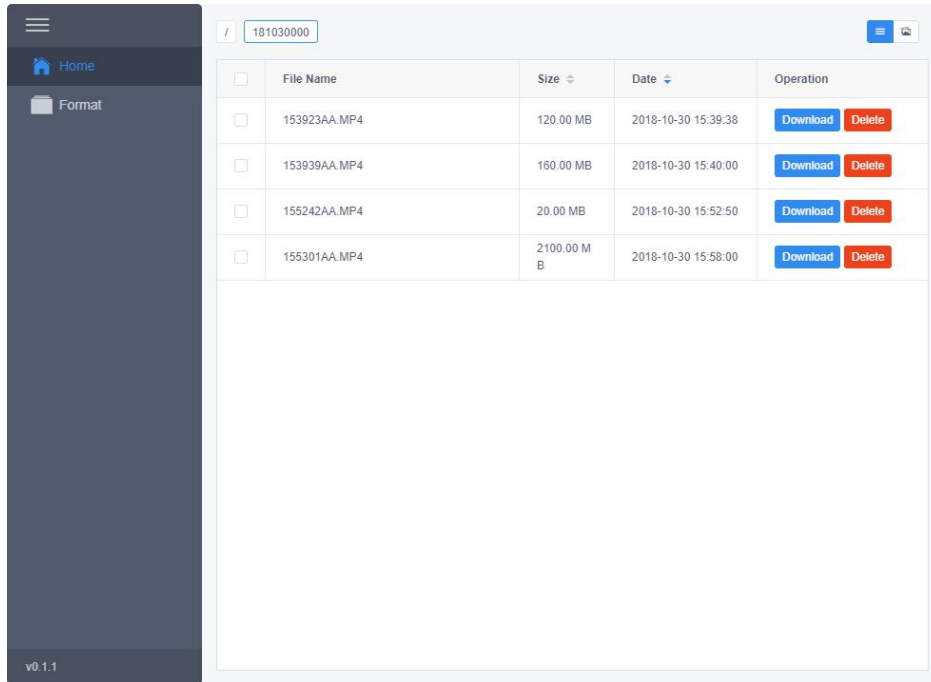

g) Click Download button and it shows download speed the same time.

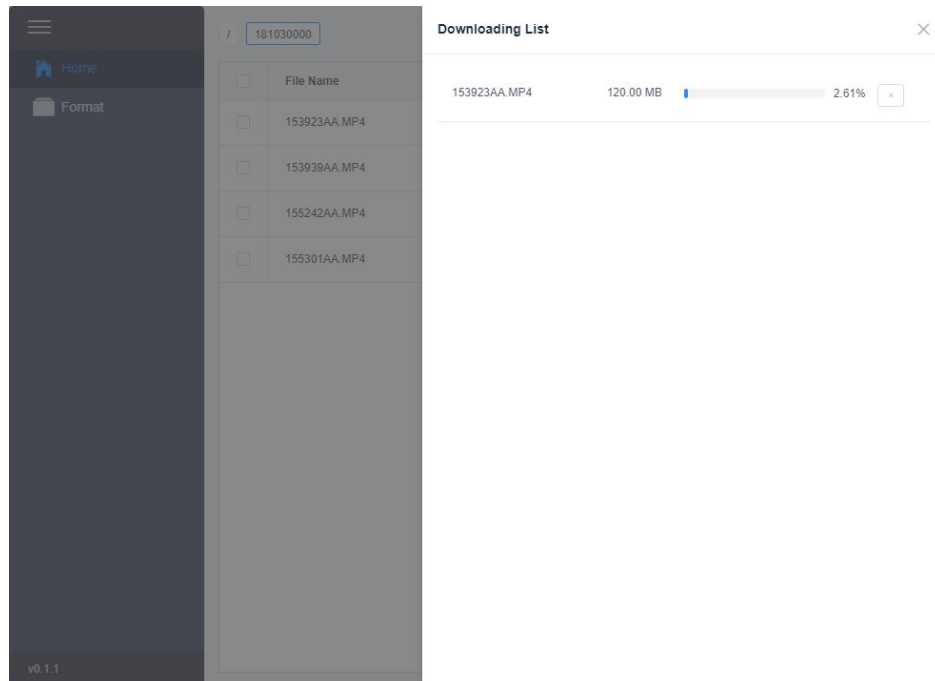

h) Choose files to be deleted, click the Delete button and confirm again to delete files.

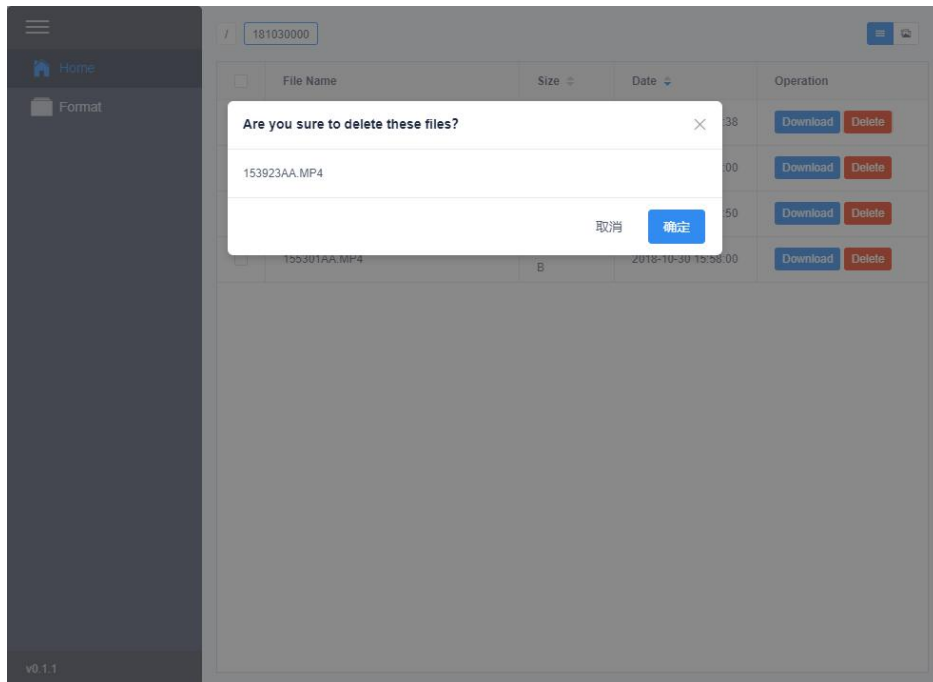

i) Format the Nemo. Click Format and confirm again whether to format the SD card, click OK.

Notes: Nemo tool only compatible with Window system.

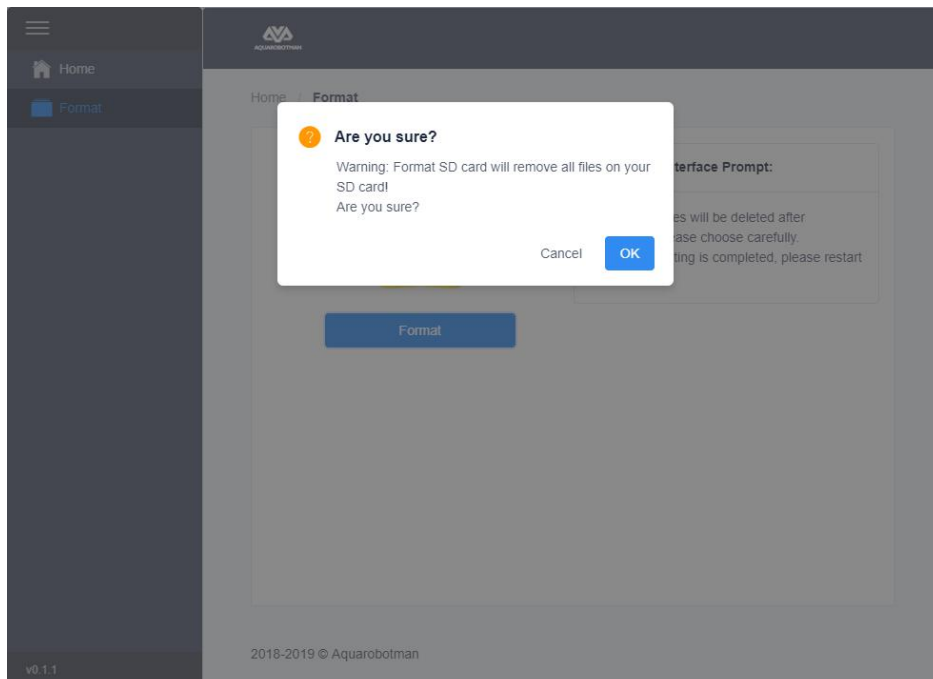

2) Download with browser

- a) Enter <http://192.168.1.2/SD/AMBA/> with your browser (Microsoft Edge recommended). You should see the interface below:

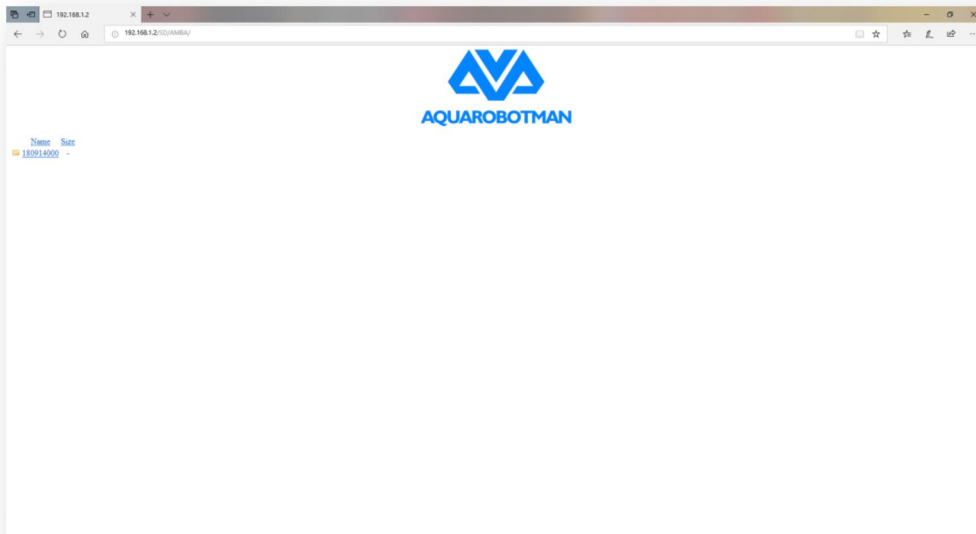

- b) Click the folder of corresponding date

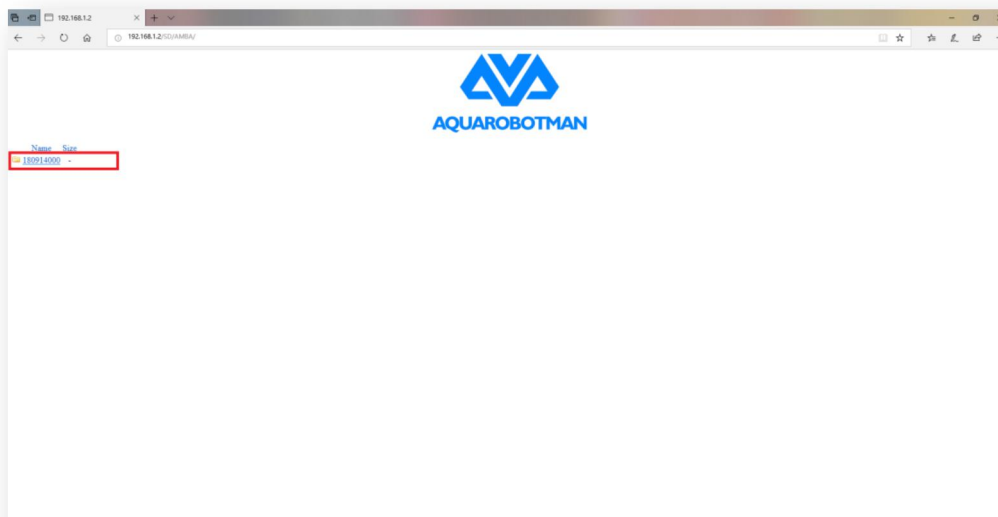

- c) Expand the video list and select the corresponding video or photo files, right click -> save target as.

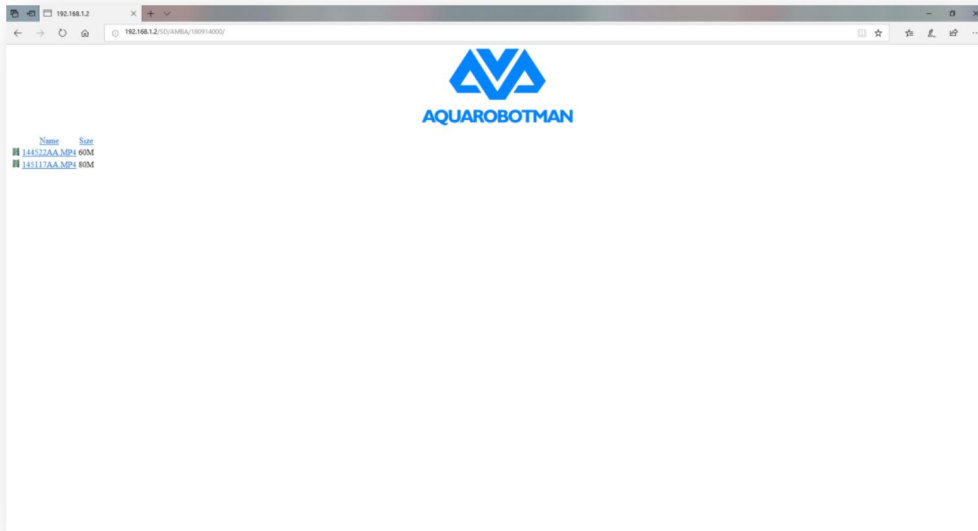

- d) Windows users please change the file extension on your own. The downloaded file has a .html extension, change this to MP4. This operation is not required for Apple systems.

## Sensor Calibration

Sensor calibration is requested for first-time use. After this, the sensors can be calibrated as required. The sensors that need to be calibrated include the compass and depth sensors.

### 1. Depth calibration:

hold the underwater drone on a horizontal surface and press button of depth calibration on the App to start calibrating, then fill light will turn on. Once fill light turns off, the calibration shall be completed. Whole process takes you 2s.

### 2. Compass calibration:

after pressing compass calibration, please rotate the drone in 360° space (horizontal 360°, vertical 360°, lateral reversal 360°) until the calibration completed. The whole process takes you 30s.

Interface show as below:

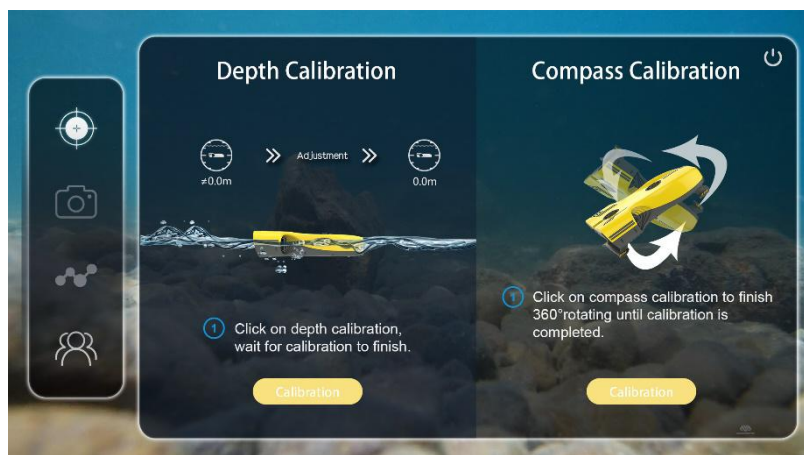

## Battery Charging

The battery can be charged only with charger provided by Nemo.

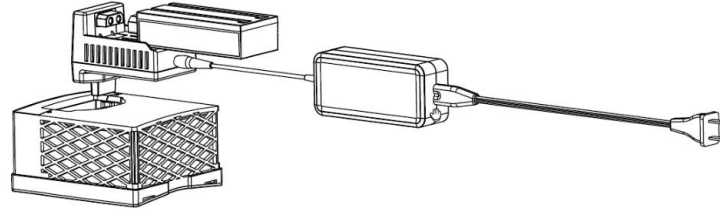

1. The battery light will turn red while charging.
2. The light will turn green when the battery is fully charged.
3. Two batteries can be charged at the same time or charged separately.
4. Notes:
  - a) Please use adapters provided by Aquarobotman only.
  - b) Please use chargers provided by Aquarobotman only.

## Backpack Usage

Nemo backpack is specially designed for the storage of the drone and its accessories. It has a strong capacity and can store all the unites in one backpack including the drone, reel, signal cable, battery and chargers. The backpack is made of nylon and tough sewing to carry a weight of up to 30kg. Improper usage with overloaded items may result to partial cracking and damage

The backpack is composed of a main bag and an additional bag. The main bag for the drone has other three compartments to store battery, adapters and other accessories there. The additional bag is for the cable reel.

Recommended storage as below:

1. The drone stored in main bag.
2. The drone battery, adapter stored in the small compartments (the left and right one)
3. The possible backup batteries stored in the upper compartment.

Notes: Please don't store two drone batteries (if you have a backup one) in the left and right compartments at same time, which will make the zipper difficult to pull back. Please refer to the methods mentioned above

## Precautions

Things to be aware of when using this product.

### Usage Environment Requirements

Water quality: seawater or freshwater.

Temperature: water temperature should be between -2°C to 35°C.

Water depth: 0 - 100 meters.

Water environment: no obvious aquatic plants or other obstacles

### Examination before Usage

#### 1. Main unit (the drone)

- a) Ensure the protective rack is installed.
- b) Ensure the camera lens is clean without any attachments.
- c) Ensure the propellers are clean without any entanglements inside.
- d) Ensure the camera filters are properly attached.
- e) Ensure the KEVLAR signal cable joint is clean and free of debris.
- f) Ensure the battery and electrodes compartment are clean and free of debris.

#### 2. Wi-Fi base station

- a) If you have a reel, check to see if it rotates properly.
- b) Ensure the power switch and the indicator light is working normally.
- c) Ensure that the signal cable is intact with no damage.

### Post-use Maintenance

Users shall perform the following maintenance after usage.

- a) Rinse or soak the main unit with freshwater (soak with the battery installed).
- b) Wash the reel and KEVLAR cable with freshwater.
- c) Unload the battery of drone and turn off the power supply for the base station to prevent the battery from excessive discharge.

### Media Data Export

To prevent the drone from overheating when exporting raw data, please immerse the front half of the drone in cool water.

Possible issues:

Possible issues:	Solution
------------------	----------

- 1 Not washing the underwater drone with fresh water in time after retrieving the drone from the sea causing a layer of crystal salt on the underwater drone surface

Put the drone in fresh water for a while and wait until the salt dissolves off the surface.
- 2 The drone got wrapped with aquatic plants or other stripy materials while operating underwater causing it to enter protective state

Remove the drone out of water and clean the propeller blades, restart it and use again. Users are advised to avoid complex aquatic environment with lots of plants.
- 3 Sand or rocks got into the drone while traveling near the seabed

Shake the drone in water to clean.
4. Only one Wi-Fi "Aquarobotman" in the Wi-Fi list of mobile or tablet, Wi-Fi "Nemo" is not detected.

Check whether the Nemo battery is fully charged and well installed. Make sure the joint of signal cable is in good contact with the drone.
5. There are two Wi-Fi signals, What does "Nemo" and "Aquarobotman" separately stand for?

"Aquarobotman" is the base station Wi-Fi, which is used to transmit signals and can be used underwater or on land.  
"NEMO" is the drone Wi-Fi, which can only be used on land.  
When the drone enters water, this Wi-Fi cannot be seen in Wi-Fi list. If Nemo Wi-Fi is not listed when on the shore, then the battery is not well installed, please install the battery again.
6. APP stops at the beginning interface and error message received.

Ensure the drone battery is well installed, the signal cable connector is in good contact with Nemo, and there are two Wi-Fi signals listed. After all of that please have Wi-Fi "Aquarobotman" connected, exit the APP, reopen it and try again.
7. For the maiden usage of the drone, it is difficult for it to submerge, or the drone automatically float upwards after submerging.

There are cavities full of air inside the drone body, when the posture of water entering is not correct the buoyancy would be too high, that results to above problems. The correct posture is to make the drone heads vertically downwards into the water, thus the air shall be expelled out.



## Appendix

### Specifications

Underwater drone	Parameter
Structure	4 propellers (2 vertical + 2 horizontal)
Dimensions	40.4*29.0*11.4cm
Weight	3.4KG
Dynamic System	Waterproof and anti-corrosive motors, high efficiency 5-blade propellers
Maximum moving speed	2m/s
Maximum diving depth	100m
Storage	32G/64G
Wi-Fi base station	Parameter
Dimensions	105mm*75mm*159mm
Weight	337g
Signal frequency	2.4G
Maximum communication range	50m
Battery	Refer to Wi-Fi base station battery
Reel Wi-Fi base station	Parameter
Cable length	50m/100m
Dimensions	30*35*16cm
Weight	0.6kg/1.1kg
Wi-Fi base station battery	Parameter
Dimensions	47mm*120mm*27mm
Weight	150g
Battery voltage	8V
Charging voltage	8.4V
Underwater drone battery	Parameter
Dimensions	112mm*125mm*65mm
Weight	760g
Battery voltage	11.1V
Charging voltage	12.6V
Charging current	2A
Nemo battery charger	Parameter
Dimensions	68.5mm*53mm*85mm
Weight	

Input voltage	15V
Output voltage	12.6V / 8.4V
Nemo filter	Parameter
Dimensions	70mm*45mm*10.5mm
Weight	10g
Protective rack	Parameter
Dimensions (the head section)	75mm*220mm
Dimensions (the tail section)	45mm*220mm
Weight	313g
Camera	Parameter
Video resolution	4K:3840X2160 30P 16:9 2.7K:2704X1520 30P 16:9 1080P:1920X1080 30P 16:9 1080P: 1920*1080 120P 16:9 720P:1280x720 30P 16:9
Image pixels	16M (4608x3456 4:3) 14M:4252x3264 4:3 12M:4000x3000 4:3 8.3M:3840X2160 16:9
Burst mode	Off, 3 shots/sec, 5 shots/sec
Time-lapse photo	Off/1s/2s/5s/10s/30s
Video quality	Normal/good/very good
Video watermark	Off/on

## After-sales and service warranty Information

Details on after-sales return policy and warranty policy.

### Product return and exchange policy

1. Goods can be returned if the following conditions are met.
  - a) The customer returns the product within 7 days of receiving it; the product is free from damage or defects; the outer packaging, accessories, gifts, and instruction manual are intact and free from any man-made damage that would prevent the item from being resold.
  - b) The customer find the product damaged by non-human factors with performance failure, report it to us within 7 natural days after product receiving
2. In the situations below, we reserve the right to reject customers' requests for product returns
  - a) Return requests are made after 7 days of receiving the product.
  - b) The returned product is not intact; the outer packaging, accessories, gifts, and instruction manual are incomplete; or there is man-made physical damage to the product.
  - c) Valid purchase documents or invoices can't be provided;
  - d) Product with problems caused not by the quality of the product itself, but by users' improper storage, unsupported modification, improper installation, and failure to use.
  - e) The product is damaged due to force majeure as fires, floods, lightning strikes, traffic incidents etc..
  - f) Customer fails to mail out the product within 7 days after return application made with customer support.
  - g) Other circumstances described in the policy.
3. Goods can be exchanged if the following conditions are met
  - a) Within 15 days of receiving the product, the product is found to be damaged during shipping and the customer is able to provide proof of damage issued by the shipping company;
  - b) Within 15 days of receiving the product, the product is found to be grossly inconsistent with the original product description in one or more important aspects.
  - c) Within 15 days of receiving the product, the customer discovers performance failure issues that are not due to man-made factors and damage.
4. In the situations below, we reserve the right to reject customers' requests for product exchanges
  - a) Product exchange requests that are made after 15 days of receiving the product;
  - b) Valid purchase documents or invoices can't be provided.
  - c) Product to be exchanged is incomplete or has man-made physical damage;
  - d) Products with no issues found by Aquarobotman technical support team.
  - e) Products with problems caused not by the quality of the product itself, but by users' improper storage, unsupported modification, improper installation, and failure to use.

- f) The product is damaged due to force majeure as fires, floods, lightning strikes, traffic incidents etc.
- g) Customer fails to mail out the product within 7 days after return application made with customer support.
- h) The product damaged during transportation, but no valid damage certificates issued by related company provided.
- i) Other circumstances described in the policy.

## Warranty policy

If there are performance failures during the warranty period, you can apply for our product warranty service.

1. To enjoy full coverage under the product warranty, the following conditions must be met:
  - a) The product is normally used within the specified product warranty period, there is no performance failure caused by man-made factors.
  - b) The product has not been disassembled beyond what is specified and allowed in the instruction manual, and there are no unsupported modifications or damages attributable to man-made factors.
  - c) Related valid purchase documents, invoices can be provided.
2. The following conditions are not covered by the product warranty
  - a) Impact and burning that are due to man-made factors and are not attributable to the quality of the product itself.
  - b) Damage caused by modification, disassembly, or dismantling of the product without official instructions;
  - c) Damage caused by improper installation, usage, and operation that are not in accordance with the instruction manual;
  - d) Damage caused by self-repair or installation of components without official instructions;
  - e) Damage caused by improper circuit modification or the use of incompatible battery packs and chargers without official instructions;
  - f) Damage caused by operating the product in ways that are not in accordance with the instruction manual;
  - g) Damage caused by operating the product in harsh environments, including large waves, complex water environment, and places with low visibility;
  - h) Damage caused by operating the product in situations where there is interference with other wireless devices; this includes Wi-Fi signal interference, etc.;
  - i) Damage caused by loading the product beyond the safe weight;
  - j) Damage caused by forcibly starting or operating the product with ageing or damaged components;
  - k) Damage caused by reliability or compatibility issues from operating the Aquarobotman with unauthorized third-party components;
  - l) Damage caused by insufficient discharge from using batteries with quality problems when the

product battery level is low;

- m) The customer fails to mail out the product within 7 days of initiating the warranty service process with customer support.

- *THE END* -