

Case Study Furniture® Knock Down Fastback (Queen Size)

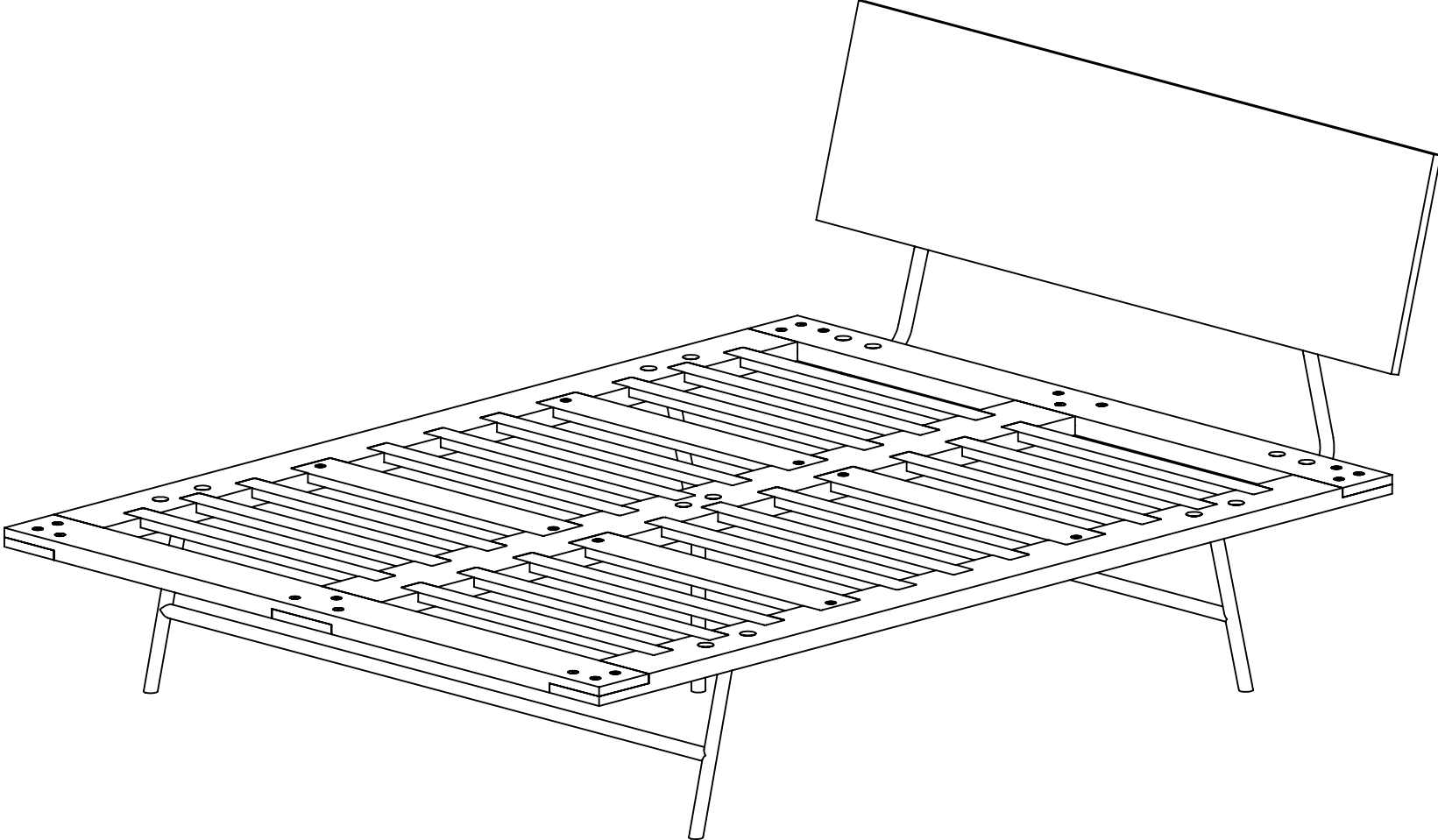

# Case Study Furniture® Knock Down Fastback (Queen Size)

## Parts List

Side Rails  
(2 pieces)

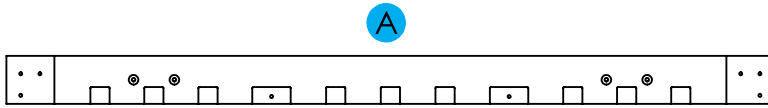

Center Rail  
(1 piece)

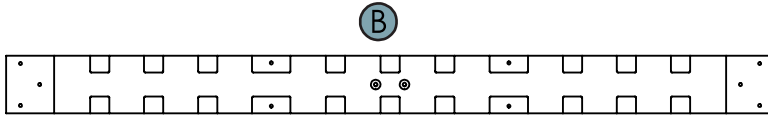

Head Rail  
(1 piece)

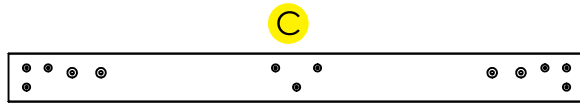

Foot Rail  
(1 piece)

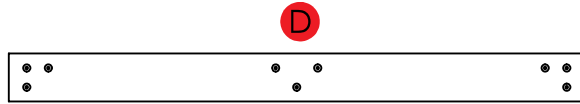

Cross Brace  
(4 pieces)

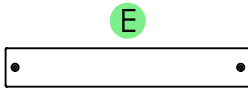

Slats  
(18 pieces)

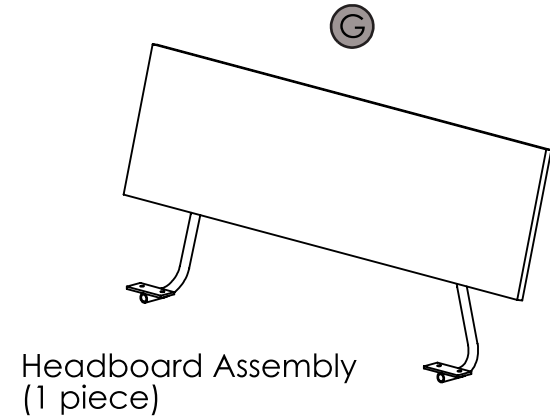

Headboard Assembly  
(1 piece)

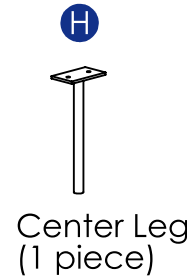

Center Leg  
(1 piece)

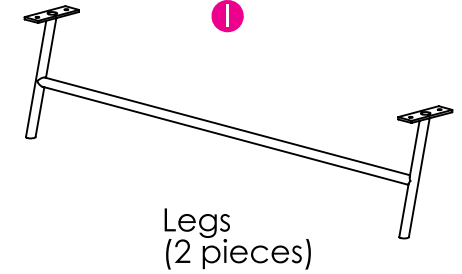

Legs  
(2 pieces)

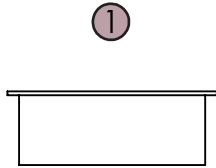

Plastic Cap  
(14 pieces)

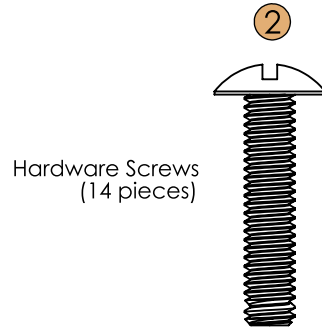

Hardware Screws  
(14 pieces)

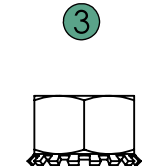

Hardware Nuts  
(14 pieces)

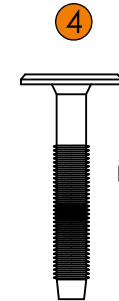

Platform Screws  
(26 pieces)

# Case Study Furniture® Knock Down Fastback (Queen Size)

## Assembly Sheet 1 (Platform)

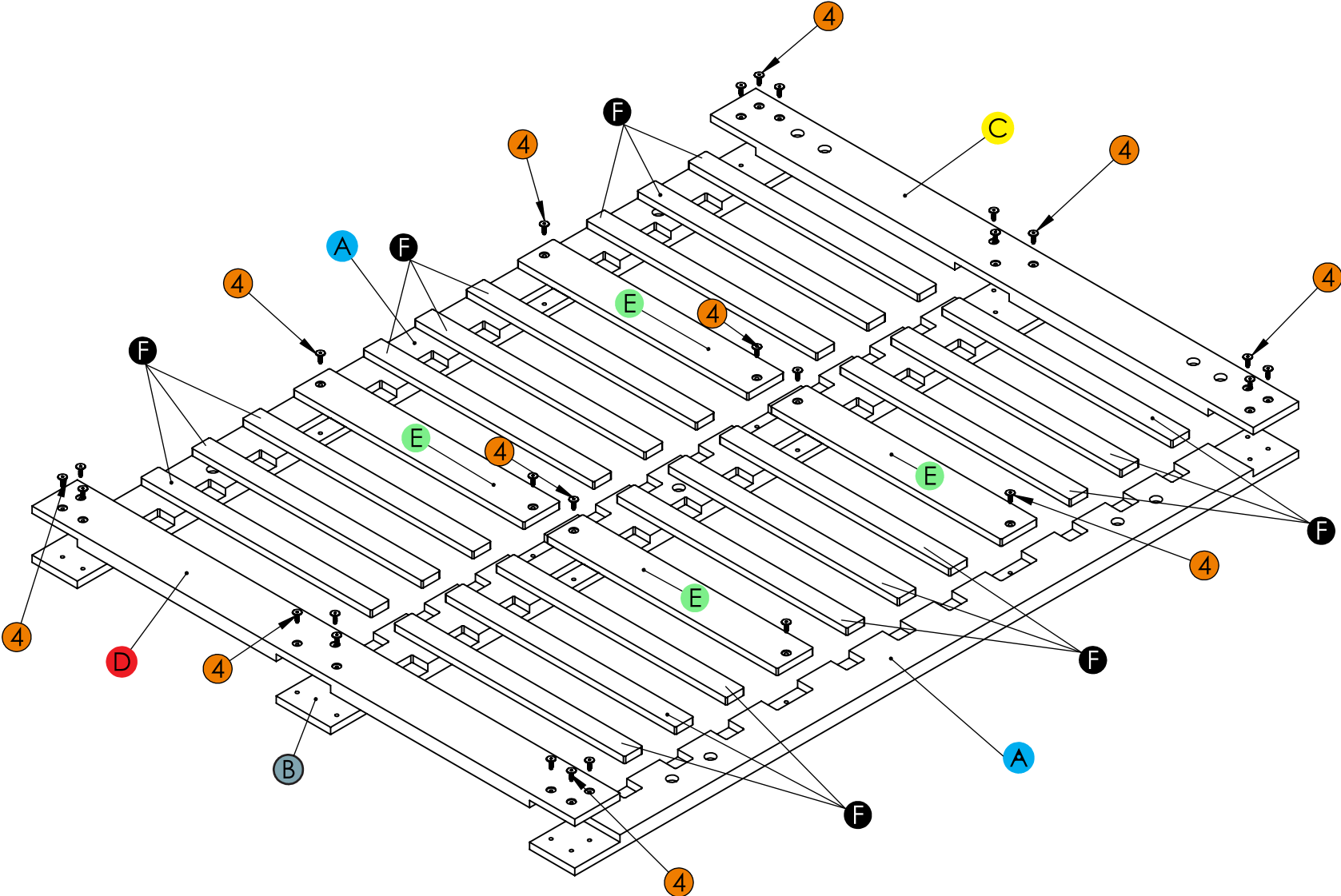

# Case Study Furniture® Knock Down Fastback (Queen Size)

## Assembly Sheet 2 (Legs and Headboard)

