

Case Study Furniture® Knock Down Bentwood (King Size)

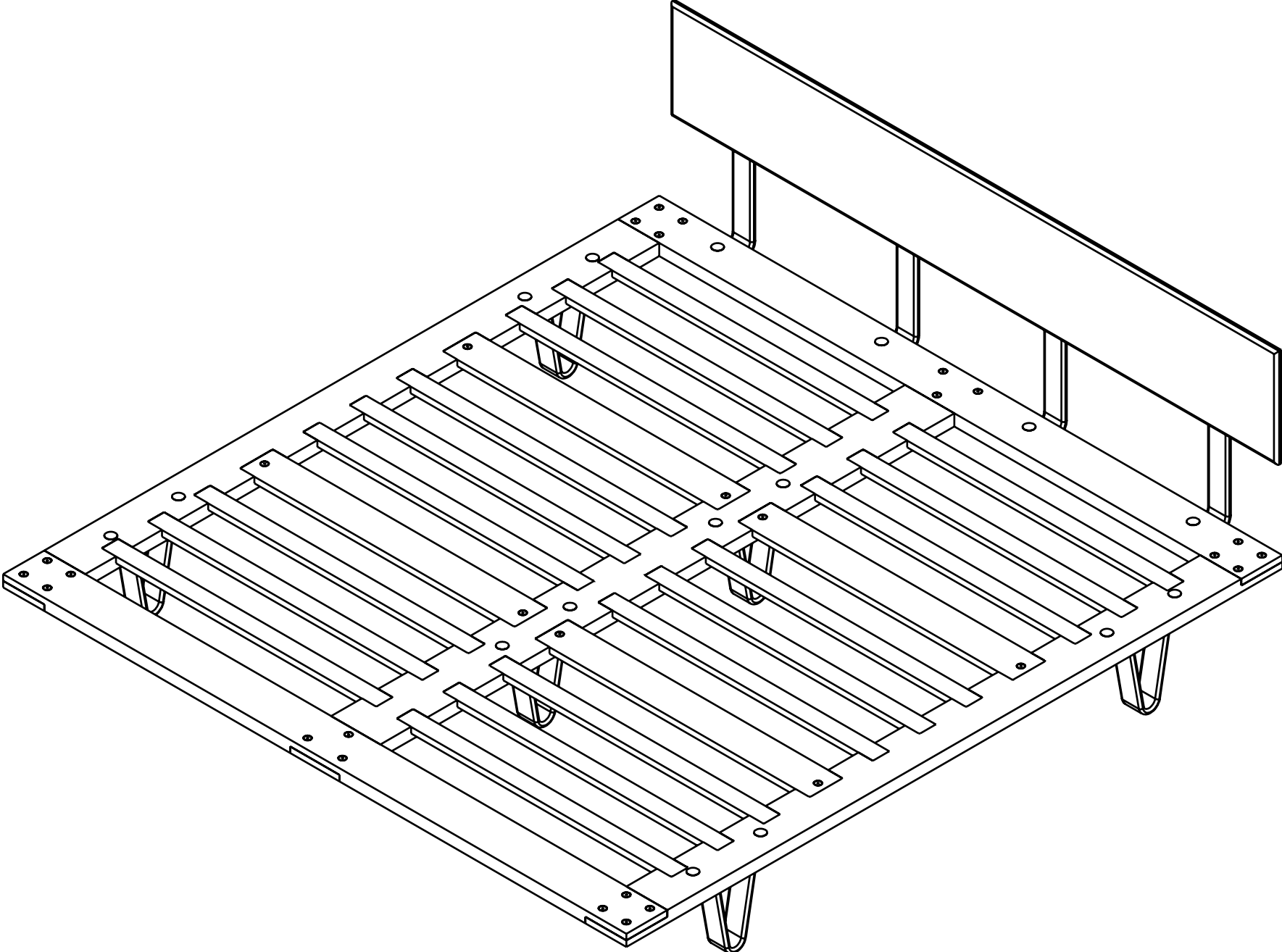

Case Study Furniture® Knock Down Bentwood (King Size)

Parts List

Side Rails
(2 pieces)

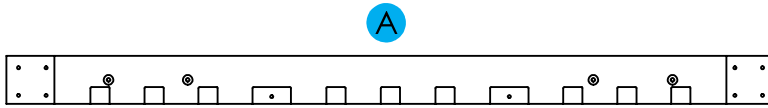

Center Rail
(1 piece)

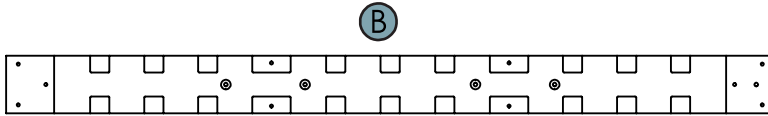

Head Rail
(1 piece)

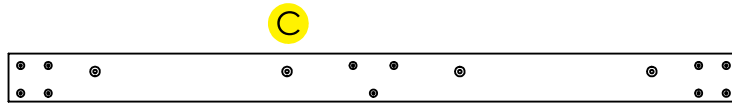

Foot Rail
(1 piece)

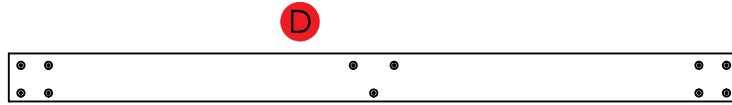

Cross Brace
(4 pieces)

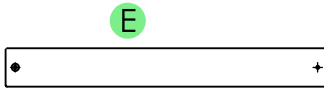

Slats
(18 pieces)

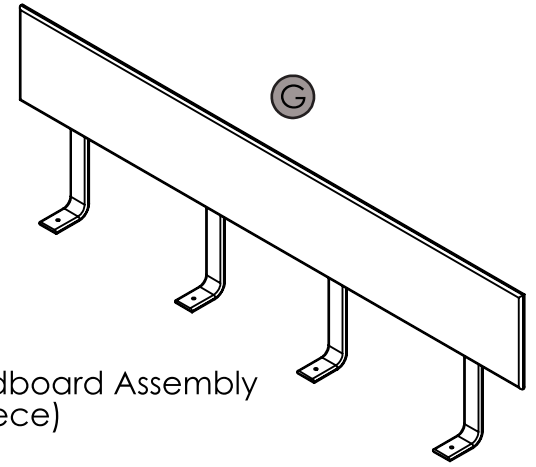

Headboard Assembly
(1 piece)

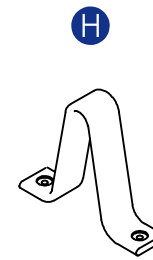

Legs
(6 pieces)

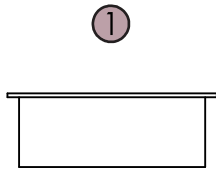

Plastic Cap
(16 pieces)

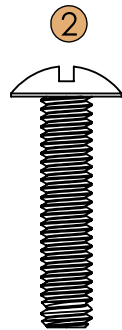

Leg Screws
(12 pieces)

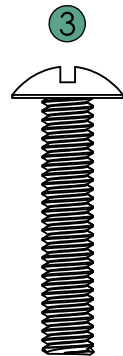

Headboard Screws
(4 pieces)

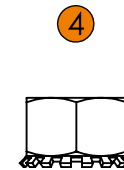

Hardware Nuts
(16 pieces)

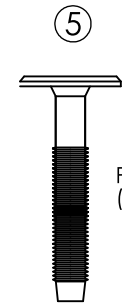

Platform Screws
(30 pieces)

Case Study Furniture® Knock Down Bentwood (King Size)

Assembly Sheet 1 (Platform)

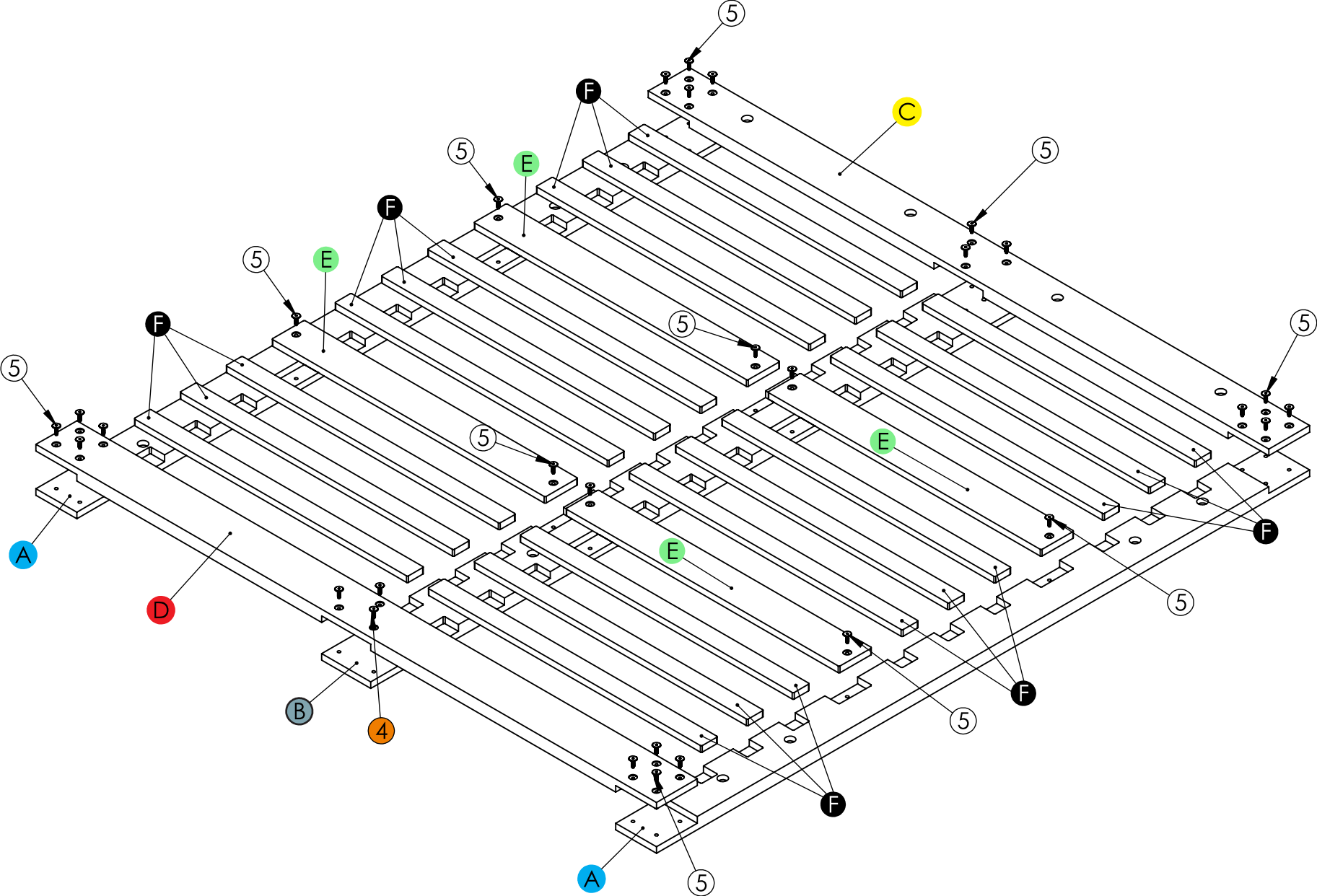

Case Study Furniture® Knock Down Bentwood (King Size)

Assembly Sheet 2 (Legs and Headboard)

