

Case Study Furniture® Knock Down Bentwood (Full Size)

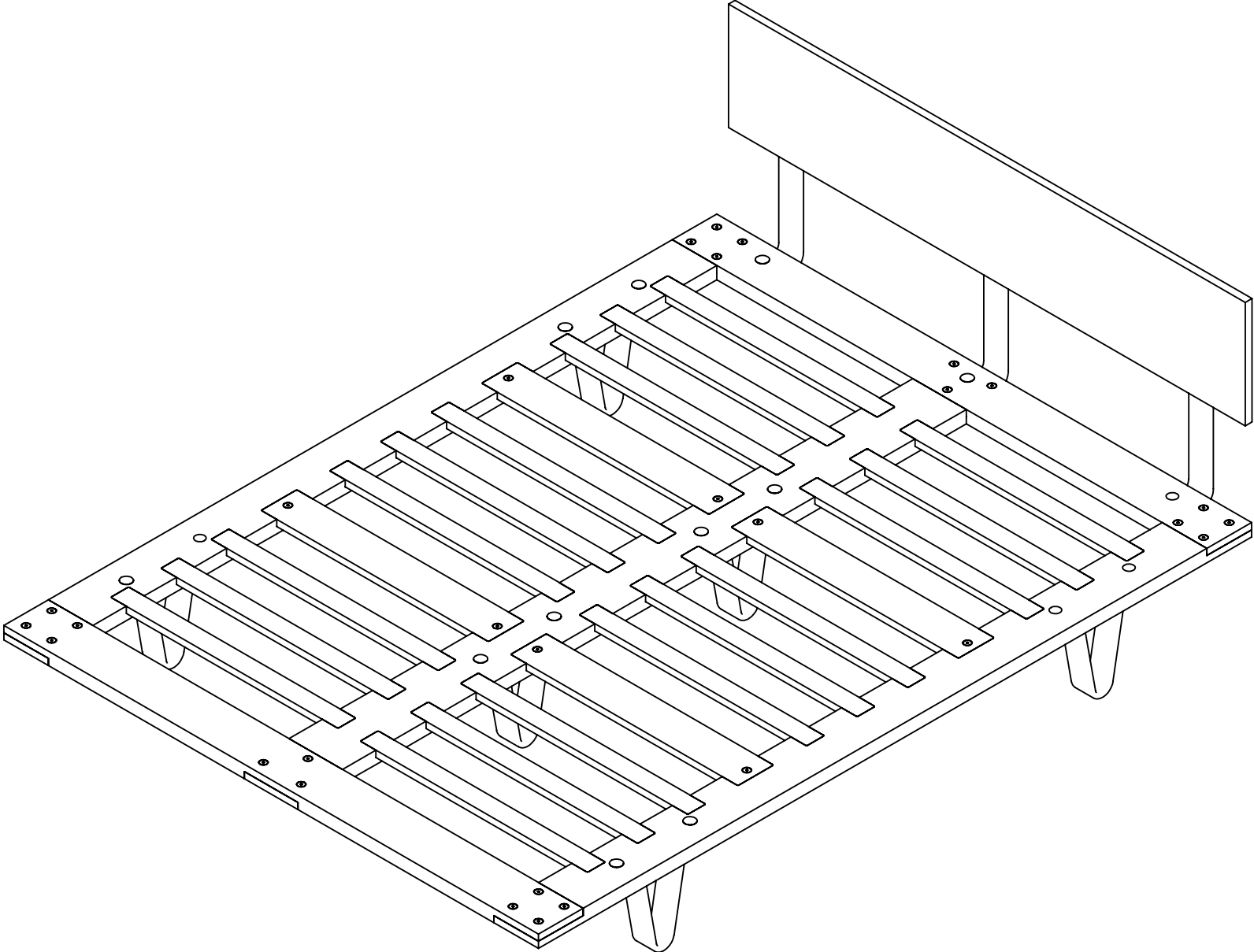

Case Study Furniture® Knock Down Bentwood (Full Size)

Parts List

Side Rails
(2 pieces)

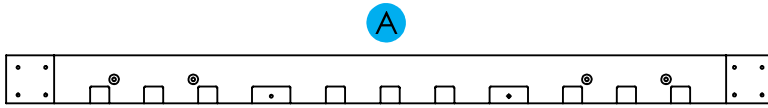

Center Rail
(1 piece)

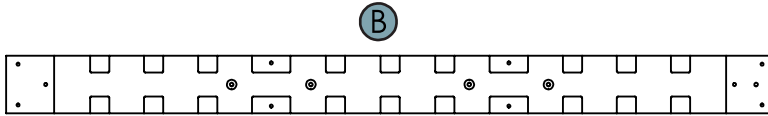

Head Rail
(1 piece)

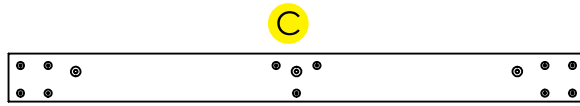

Foot Rail
(1 piece)

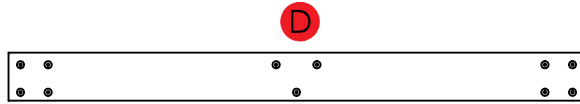

Cross Brace
(4 pieces)

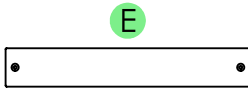

Slats
(18 pieces)

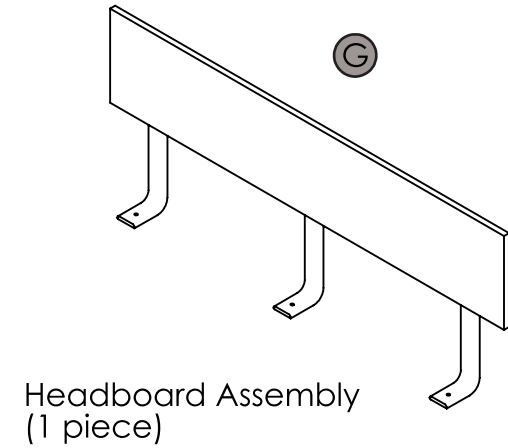

Headboard Assembly
(1 piece)

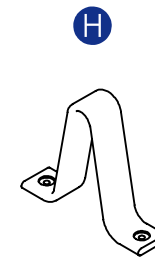

Legs
(6 pieces)

①

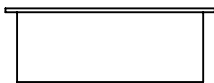

Plastic Cap
(15 pieces)

②

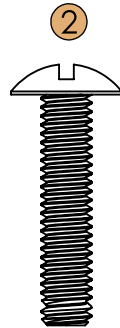

Leg Screws
(12 pieces)

③

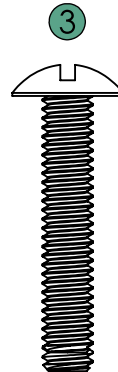

Headboard Screws
(3 pieces)

④

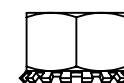

Hardware Nuts
(15 pieces)

⑤

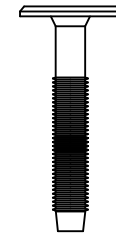

Platform Screws
(30 pieces)

Case Study Furniture® Knock Down Bentwood (Full Size)

Assembly Sheet 1 (Platform)

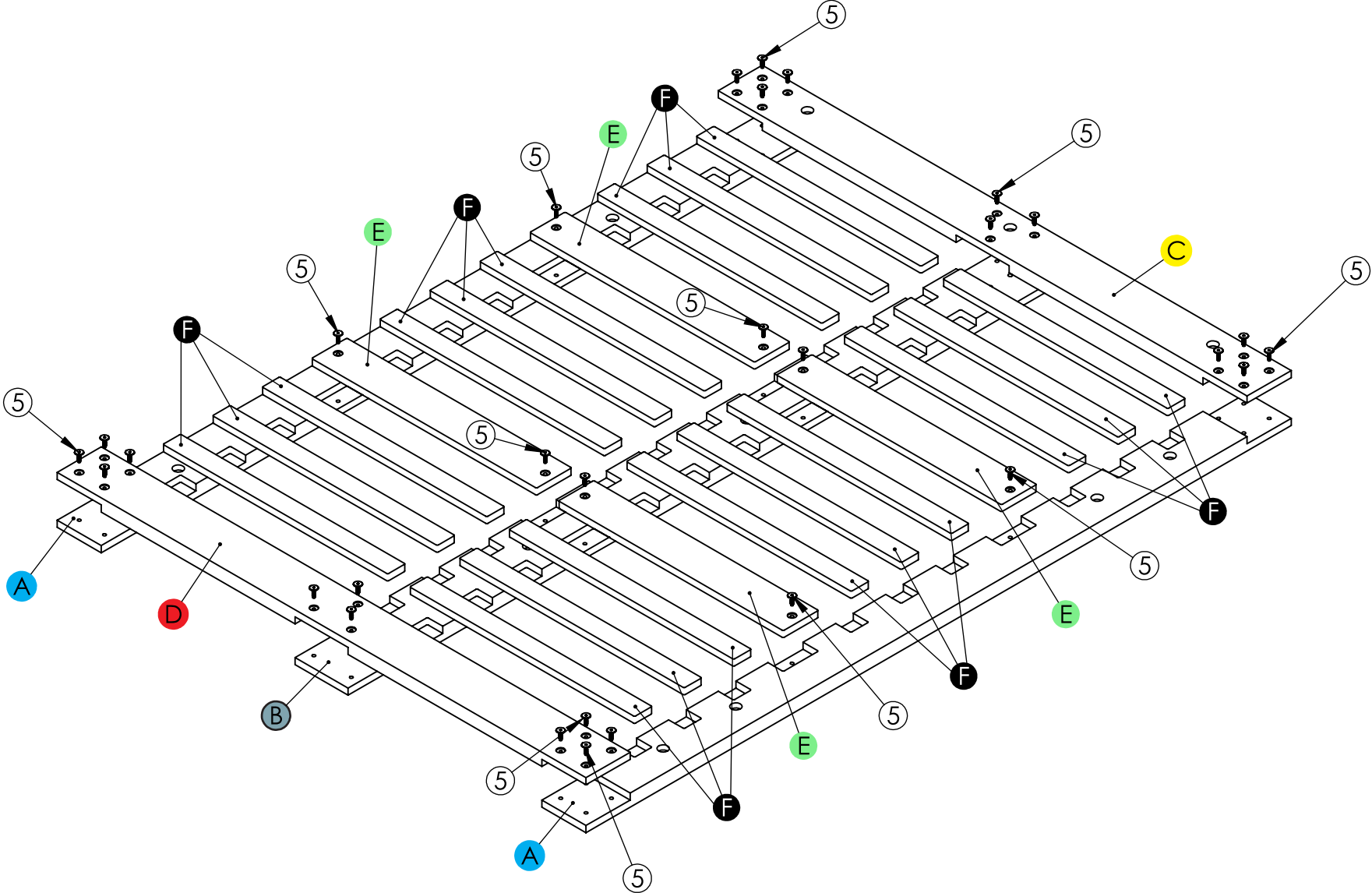

Case Study Furniture® Knock Down Bentwood (Full Size)

Assembly Sheet 2 (Legs and Headboard)

