

Case Study Furniture® Knock Down V-Leg (California King Size)

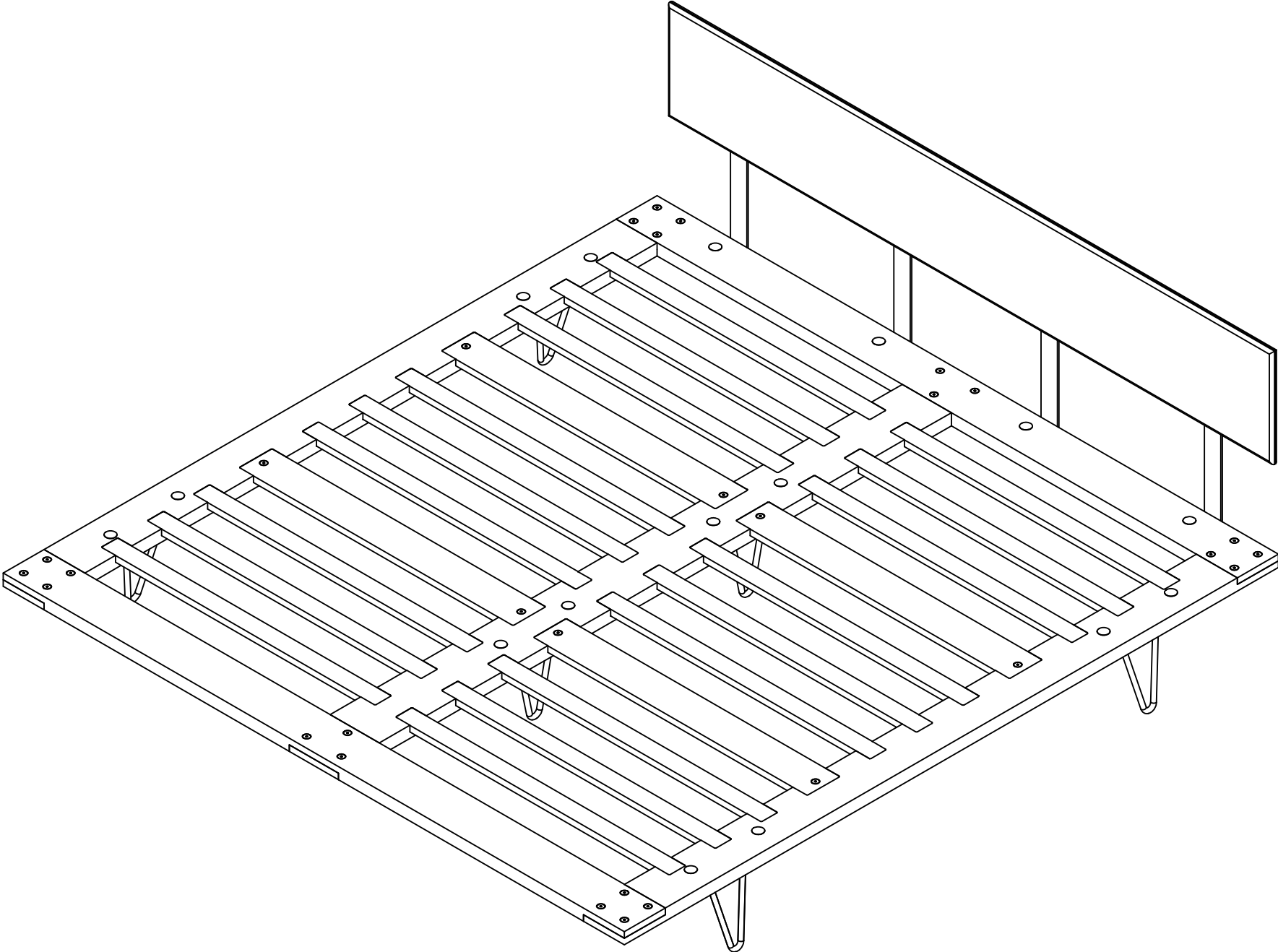

Case Study Furniture® Knock Down V-Leg (California King Size)

Parts List

Side Rails
(2 pieces)

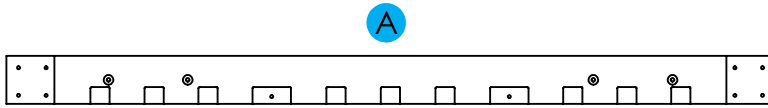

Center Rail
(1 piece)

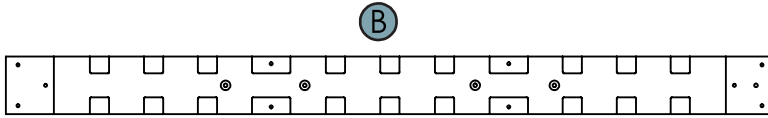

Head Rail
(1 piece)

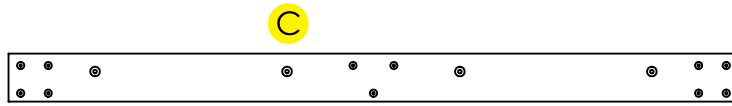

Foot Rail
(1 piece)

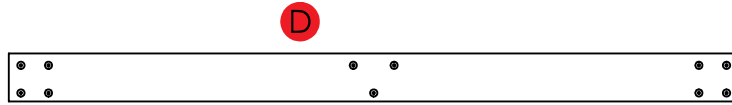

Cross Brace
(4 pieces)

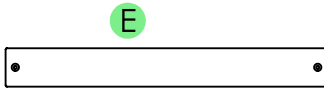

Slats
(18 pieces)

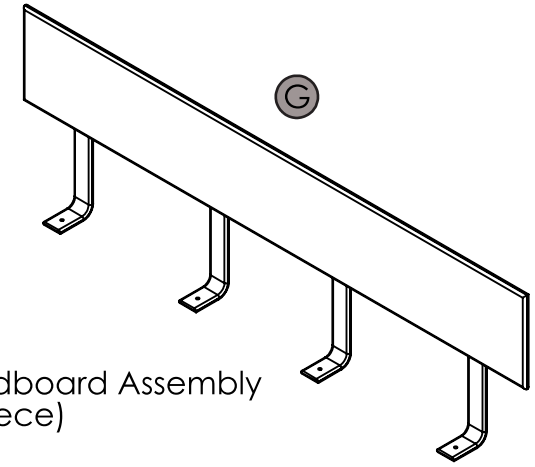

Headboard Assembly
(1 piece)



Center Legs
(2 pieces)

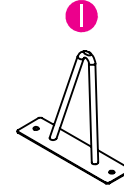

Side Legs
(4 pieces)

①

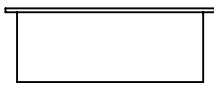

Plastic Cap
(16 pieces)

②

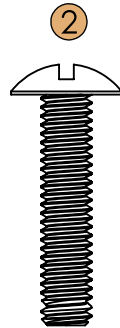

Leg Screws
(12 pieces)

③

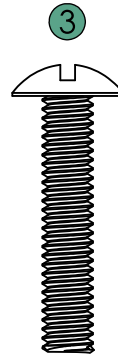

Headboard Screws
(4 pieces)

④

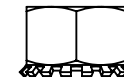

Hardware Nuts
(16 pieces)

⑤

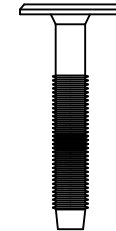

Platform Screws
(30 pieces)

Case Study Furniture® Knock Down Bentwood (California King Size)

Assembly Sheet 1 (Platform)

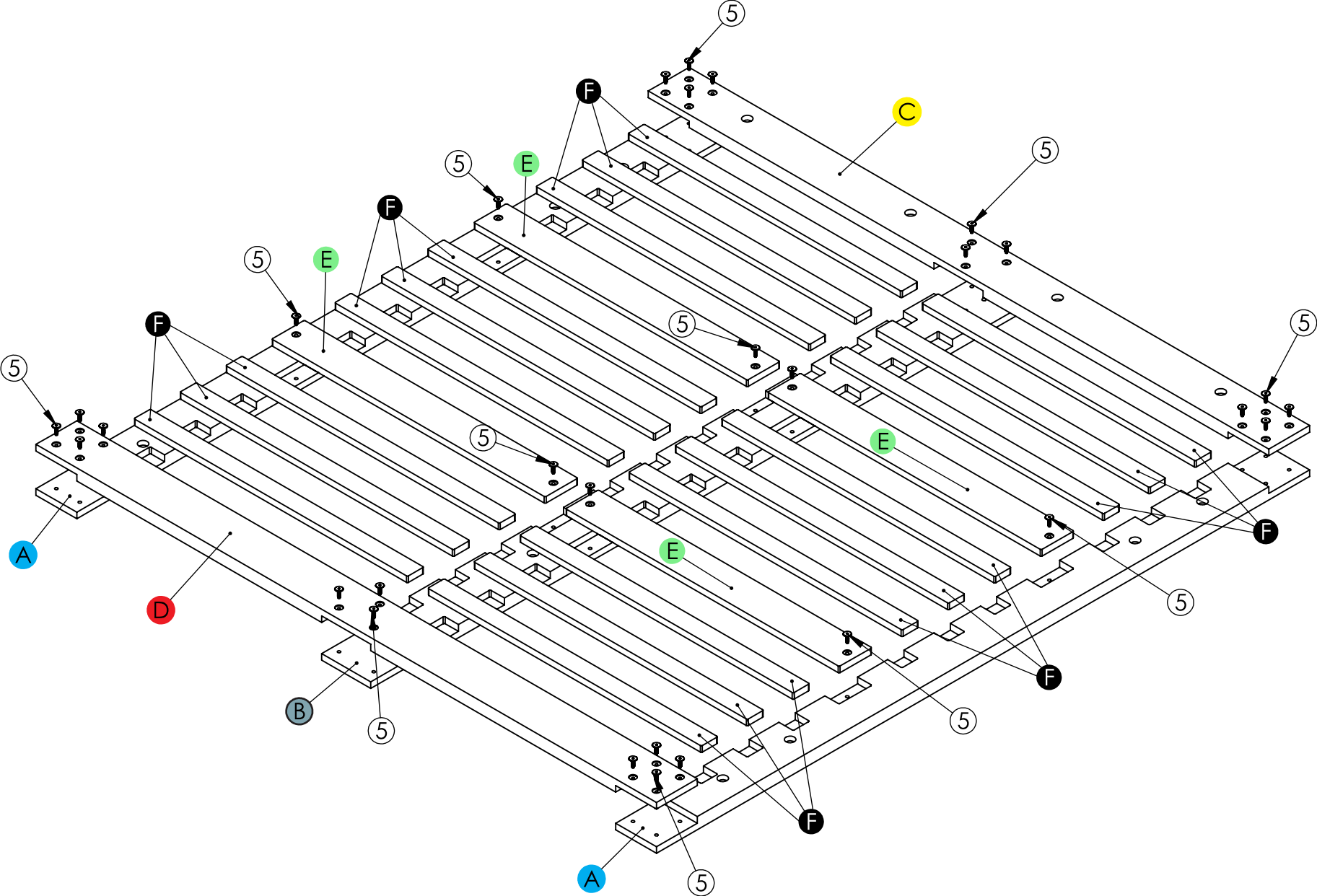

Case Study Furniture® Knock Down Bentwood (California King Size)

Assembly Sheet 2 (Legs and Headboard)

