

Owner's Manual

Odyssey Compact Dryer 227



Table of Contents



I. Introduction	3
II. Specifications	4
III. Parts for Assembly	5
IV. Safety Procedures	6
V. Assembly	
Step 1: Building the Legs and Attaching the Base	7
Step 2: Attaching the Infeed	9
Step 3: Attaching the Outfeed	10
Step 4: Installing the Belt	11
Step 5: Adjusting the Belt Tracking System	12
Step 6: Tightening the Arms and Installing Heat Shields	13
VI. Controls	14
VII. Temperature Control Programming	15
VIII. Parts List	17
IX. Wiring Diagram	18
X. Limited Warranty	19



Congratulations on your purchase of the Odyssey Compact Dryer.

Check the crate for damages. DO NOT accept the crate if there are any damages caused by improper handling during shipping. Immediately report any damages to the carrier and contact Workhorse Products at, 800-778-8779.

Be sure to inspect the crate contents IMMEDIATELY, while the carrier is still present. Even though our packaging has been designed to handle normal shipping conditions, we cannot foresee damages done by the carrier. We will not be responsible for damages that occur during transportation.

If there are damages immediately notify the driver, file a claim with the carrier and call Workhorse Products.

The Importance of the Owner's Manual:

The purpose of the Owner's Manual is to familiarize you with the parts and operations of the Odyssey Compact Dryer. There are step-by-step instructions to assemble the product, explanations of the product's key features, and additional information that will help with the maintenance of the product.

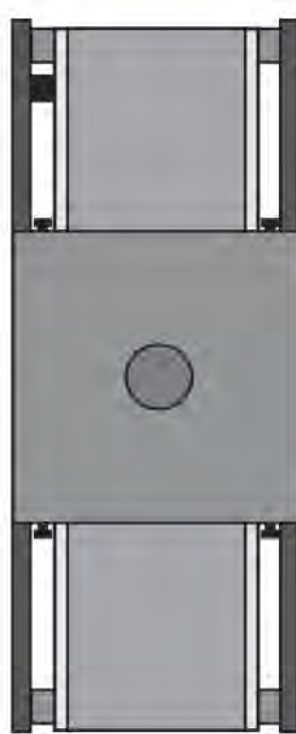

CD227

Belt Size: 22" x 7'

Production Capacity: 120+/hr.

Electric: 1-Phase, 220V, 50-60Hz,
6200 Watts, 27amps

Dimensions: 84" x 30" x 32"

Parts for Assembly

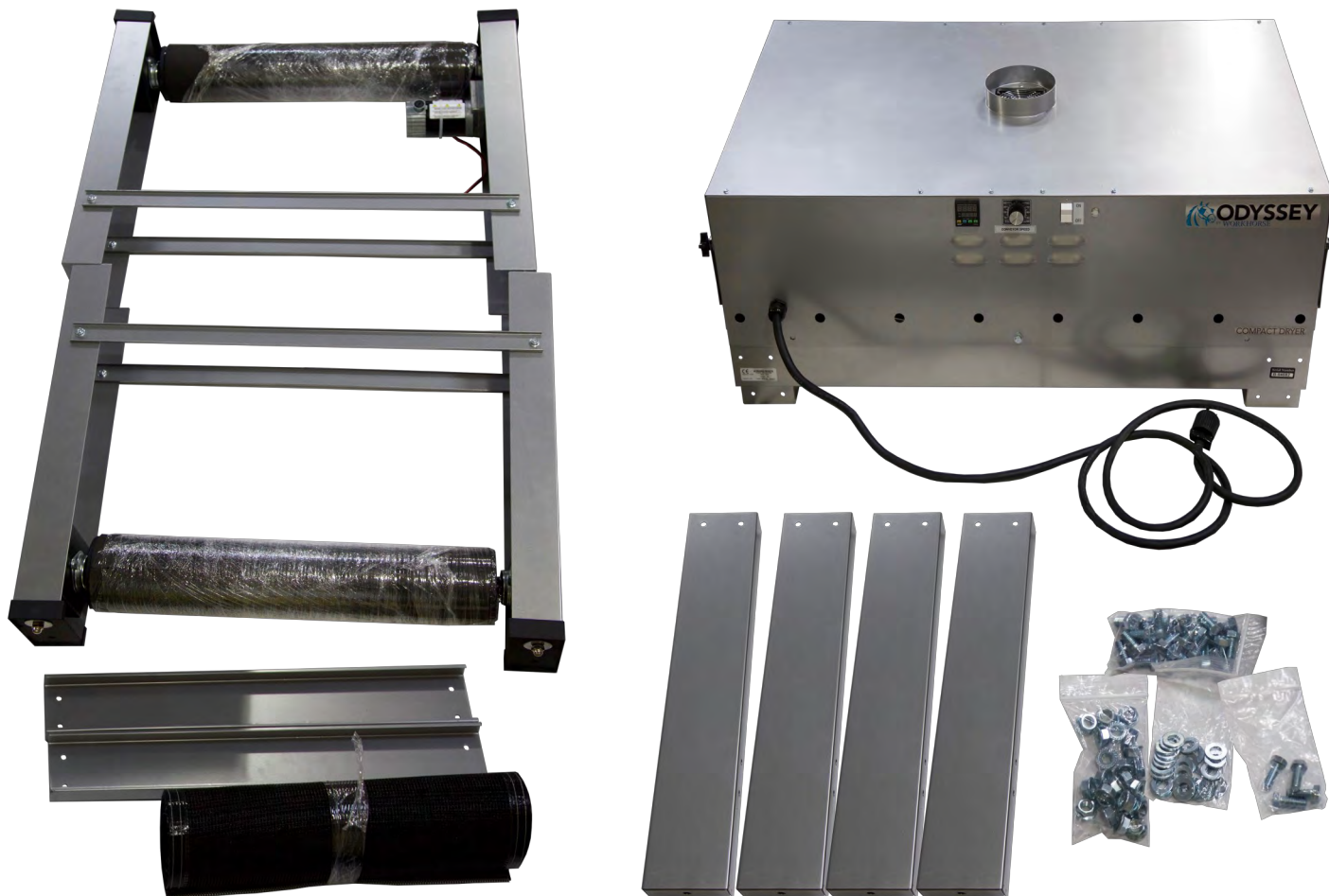

QTY	Description	Part Number
1	Dryer Body	Pre-Assembled
1	Belt	60186
24	Washers	43-FLT-M10-10
24	Flanged Lock Nut	42-FLG-375-10
4	Leg Leveling Bolt	41-HB-375-50
4	Black Knobs	74013
2	Element	20602R

QTY	Description	Part Number
2	Cross Brace	80130
2	Belt Roller Assemblies	Pre-Assembled
4	Leg	85179
1	Power Cord (115V)	390663
24	Hex Bolt (3/8-16" x 3/4")	41-HB-375-30
2	Heat Panels	80127

WARNING!

RISK OF ELECTRICAL SHOCK! Turn ALL power to unit OFF before service.

All service should be done by or under the supervision of a trained technician

1. For your safety, do not store or use gasoline or other flammable vapors and liquids in the vicinity (at least 3' (1 Meter)) of this or any other appliance.
 2. Vent lines to the outdoors must be installed by a qualified HVAC engineer on all air exhaust and gas line components equipped with a vent fitting.
 3. Proper grounding (a ground rod at the equipment footing), according to NEC requirements, must be provided for during electrical connection by a **QUALIFIED ELECTRICIAN**.
 4. Never alter the internal wiring of this machine.
 5. Never place any item other than the stock to be cured or dried on this dryer's conveyor belt. Do not overload the belt.
 6. Do not let the conveyor belt track off the conveyor drive rollers.
 7. Keep all loose articles (including clothing, hair, jewelry, etc.) away from the conveyor belt.
 8. Never leave the machine unattended when it is operating.
 9. Do not perform maintenance on this machine until all power has been shut off at the dryer **AND** at the incoming power circuit breaker.
-

THIS ELECTRIC DRYER IS INTENDED SOLELY FOR THE PURPOSE OF CURING INK ON TEXTILE AND CUT GOODS. THIS DRYER IS NOT INTENDED FOR USE IN HEATING, CURING OR BAKING OF ANY OTHER MATERIALS.

THIS DRYER IS INTENDED FOR INDOOR USE ONLY



THE EXCLAMATION WITHIN AN EQUILATERAL TRIANGLE SYMBOL IS INTENDED TO ALERT THE USER OF IMPORTANT SAFETY PRECAUTIONS TO BE AWARE OF DURING OPERATION.

Assembly



Step 1: Building the legs and attaching the base.

- | | | |
|-----------------------|-----------------------|--------------------|
| Tools needed: | Parts needed: | • 16 x Hex Nuts |
| • 9/16" Socket Wrench | • 4 x Legs & Levelers | • 16 x Washers |
| | • Base | • 2 x Cross Braces |
| | • 2 x Cross Braces | • 16 x Hex Bolts |



1. Align the holes of the cross base with the holes on the bottom of two legs. The backside of the cross brace should face out, and the inside of the brace should face in.



2. Insert a washer and a hex bolt (3/8-16" x 3/4") into the top holes. Hand tighten a lock nut onto the other side of the bolt.

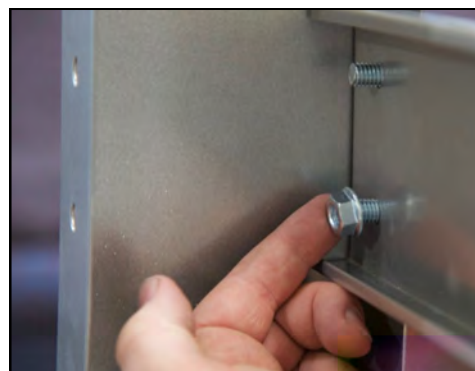

3. Insert a washer and a hex nut onto the other side of the bolt. Tighten it by hand. Repeat for the other seven bolts.

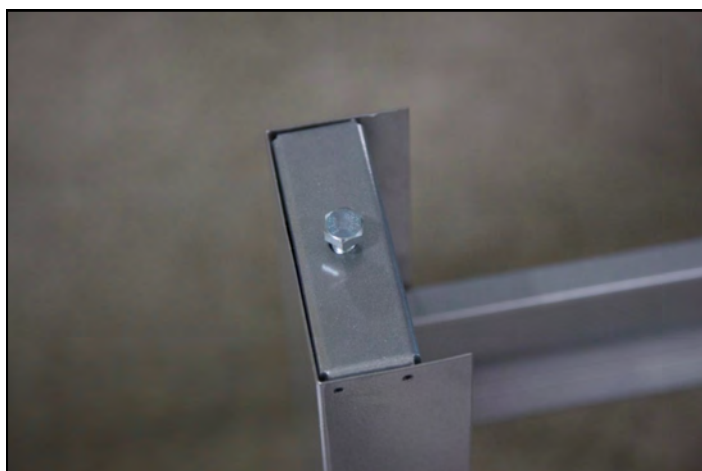

4. Turn the legs are and insert the leg levelers onto the four legs.



5. Set the legs up so they match the size of the body of the dryer.

Step 1 (Continued): Attaching the base.

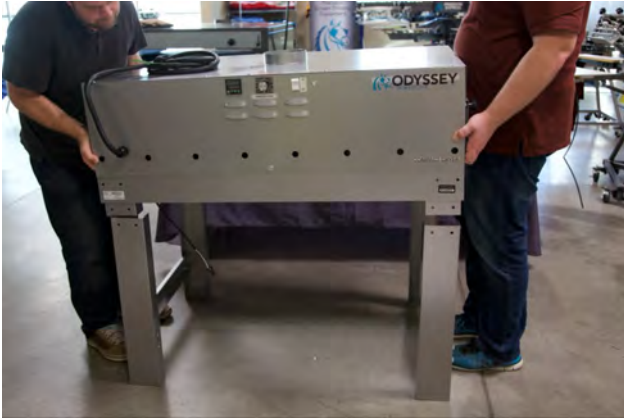

6. Set the legs up so the outsides of the cross braces are facing out. Using two people, lift the dryer body and insert the bottom corner slots into the legs.



7. With the holes of the base and the leg aligned, insert a washer and hex bolt into the outer hole.



8. Tighten a lock nut onto the other side of the bolt, which faces inside the dryer. Only hand tighten it.



9. Repeat steps 7-8 with the rest of the holes, there are eight in total.

10. After all eight holes have been installed, tighten each one with a 9/16" socket wrench. The legs and base are now installed. Be sure not to tighten too much, because they may need to be looser to fit the arms onto the base. After both arms are installed onto the base, then fully tighten the upper leg bolts.

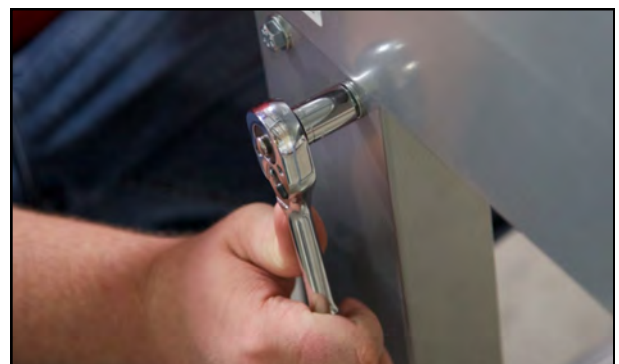

Step 2: Attaching the infeed.

Tools needed:

Parts needed:

- 9/16" Wrench
- 9/16" Socket
- Infeed Arm
- 4 x Leg Bolts
- 4 x Flat Washers
- 4 x Lock Nuts



1. The side without the wire is the side that the infeed is installed into. Slide the arms (without the motor) into the base, while aligning the holes of the arm and the base.



2. Insert a washer and hex bolt into one of the holes that connect the base and the arm.



3. Thread a lock nut onto the other side of the bolt, which is located inside of the dryer. Repeat steps 2-3 to install the other three holes.



4. Using a wrench for the inside nut and a socket for the outside bolt, tighten the nut and bolt to hold in place. Tighten the other three bolts and nuts, leaving them loose enough to adjust for leveling.

Step 3: Attaching the outfeed.

Parts needed:

- Outfeed Arm
- 4 x Flat Washers
- 4 x Leg Bolts
- 4 x Lock Nuts



1. The side with the wire is the side that the outfeed is installed into. Slide the arms (with the motor) into the base, while aligning the holes of the arm and the base.



2. Insert a washer and leg bolt into one of the holes that connect the base and the arm.



3. Thread a lock nut onto the other side of the bolt, which is located inside of the dryer. Repeat steps 2-3 to install the other three holes. Do not tighten the nuts and bolts with wrenches until the belt is installed.



4. Connect the plug located inside of the machine to the plug connected to the motor located on the arm.

Step 4: Installing the belt.

Parts needed:

- Belt
- Fastening Pin

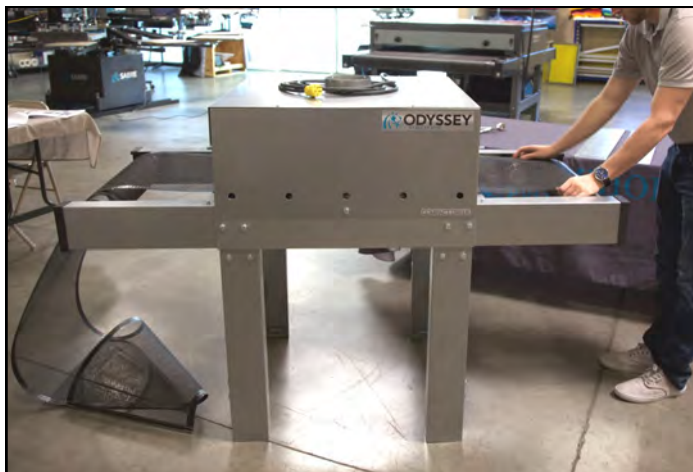

1. Thread the belt over the top of the infeed roller and over the upper cross brace. After the belt has gone through the chamber, pull the belt to hang over the outfeed roller to add weight to help with the threading of the lower portion.



2. On the infeed side, take the other end of the belt and thread it under the infeed roller and under the lower cross brace, through the lower slot on the roller/rail assembly. Guide the belt through the oven chamber so it continues through the lower slot and over the lower cross brace.

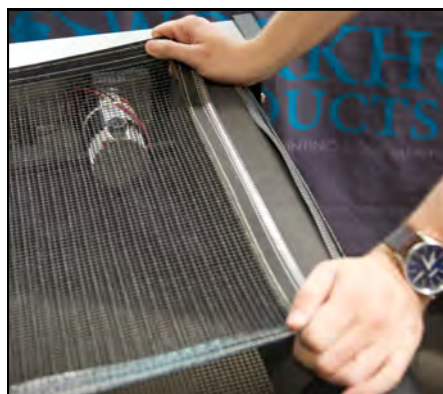

3. Thread the belt until both ends meet on the outfeed roller.



4. To install the belt it may be required to adjust the belt tracking. This is done by turning the tension bolt clockwise (to tighten) or counterclockwise (to loosen). Belt tracking will be explained more in-depth on page 11.

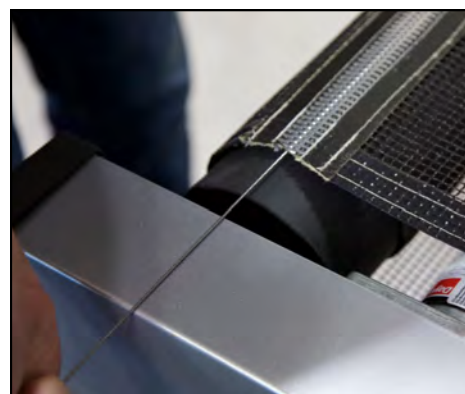

5. Align the belt closure until the teeth mesh connect, and install the fastening pin into the teeth. Hold together the teeth while installing the pin. When it's inserted and the belt is fully installed, trim any extra pin that may be jutting from the sides.

Step 5: Adjusting the belt tracking system.

Tools Needed:

- Crescent Wrench

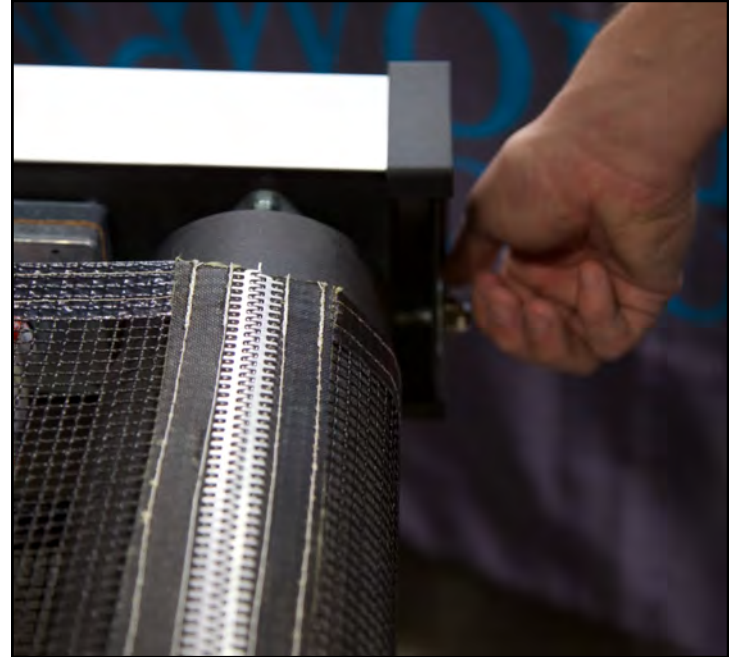

After the belt is centered on the rubber portion of the rollers, evenly adjust the tension bolts on every corner of the dryer to tighten the belt until it can be deflected by about 2 inches. Turn the dryer on and set the belt speed to 35%, as the belt moves make small adjustments to maintain the belt to be in the center of the rollers. Turn the tension bolts clockwise to tighten the belt in that corner, or turn the bolt counter-clockwise to loosen the belt in that corner.

- If the belt is tracking to the right, turn the tension bolt clockwise in 1/4 increments.
- If the belt is tracking to the left, turn the tension bolt counter-clockwise in 1/4 increments.
- Continue using the right and left tension bolts until the belt is centered.

Adjusting the belt to be centered is critical to prevent premature wear of the motor and the belt. In cases where too much belt tracking has caused the belt to become too tense, it is necessary to reset the tension bolts and start over. **DO NOT OVER TENSION THE BELT.**

Step 6: Tightening the arms and installing the heat shields.

Tools Needed:

- 9/16" wrench
- 9/16" socket

Parts Needed:

- 2 x heat panels
 - 4 x black knobs
-

1. Now that the belt is fully installed the bolts on the side of the base and arms can be tightened. Use a 9/16" wrench for the inside nut and a 9/16" socket on the outside bolt to tighten. The reason for waiting to tighten this arm is because the tension would make it difficult to install, track the belt, and level the arms.



2. Install a heat shield onto the two bolts that are extruding from the base. Screw on two black knobs onto the two exposed bolts. Repeat for the other side.

Congratulations! The Odyssey Conveyor Dryer is now fully assembled.



Controls



To safely connect the dryer to electricity, make sure the dryer is OFF and plug the unit in. To start the dryer set the belt speed and desired temperature, press ON, the indicator light will illuminate and the belt will begin turning as the elements heat up.

(A) Temperature Control:

The digital temperature control regulates the over chamber temperature. The dual display shows both the current temperature (red) and set temperature (green). When the dryer begins to reach the set temperature a small green indicator light labeled, "OUT" will illuminate. The factory recommended temperature is 310 degrees Fahrenheit. For a greater explanation of functions and controls turn to page 14-15.

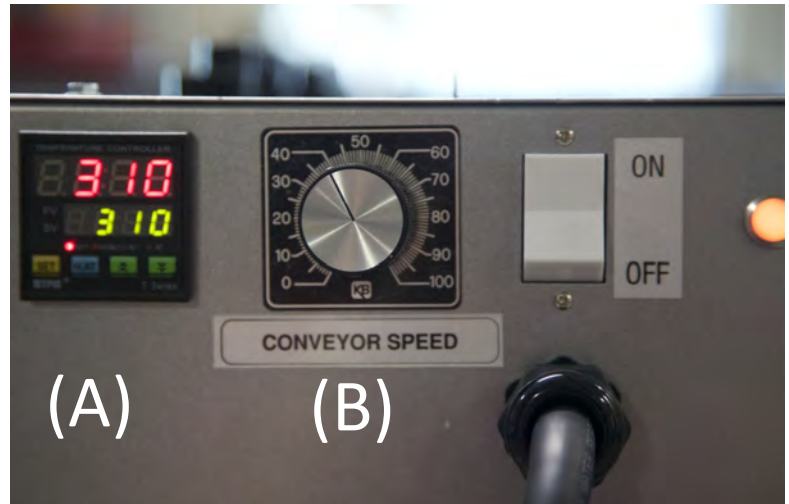

(B) Conveyor Speed:

This knob controls the speed of the belt and is based on a percentage scale. For example, if the knob is set at 40 on the indicator the belt is running at 40% out of the maximum output voltage of 90Vdc. The factory recommended speed setting is 40.

Adjust the heating shields by loosening the knobs and positioning the door into the desired position. Do not lower the shields too much because they can trap the substrate in the heated chamber.

The doors will become hot when the dryer is turned on, so use heavy gloves to adjust during operation.



Test the first dried garment with a non-contact infrared digital thermometer. Adjust the belt speed to achieve the desired ink curing temperature.

Workhorse Products carries a non-contact infrared digital thermometer to accurately measure surface temperature. Call customer service for price and availability!

MYPIN TEMPERATURE CONTROLLER WIRING AND SETTING CONVEYOR DRYERS

FUNCTION

	Press the Set button to display the % of power being used to control the output device. Press again to return to the Set Value reading.
PV =	(Large Digit at Top) Temperature reading of thermocouple
SV =	Desired Temperature – Set Value
	To change the SV setting, press and release the AT button and the far right digit will flash. You can select another digit by pressing the AT button again.
	To change the value of the flashing digit press the UP or Down button. Typical setting is 350°
	Press the Set button to save the new value.
	Press and hold the Set button to exit the setting mode.



WIRING

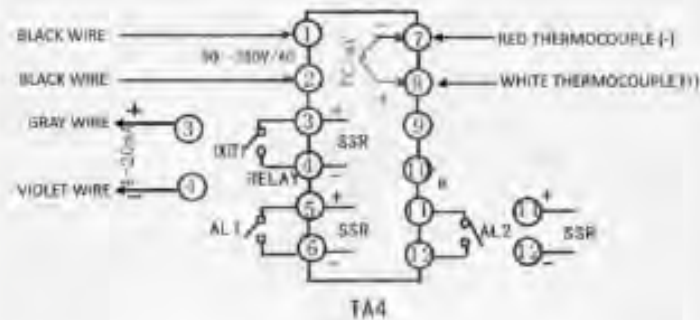

SETTINGS







There are two Parameter modes that you can access. The first has six values that can be modified. All of these values except one the controller program changes during operation, so normally you will not change these. The one value you can modify is the decimal point.

	Press and hold the Up and down buttons until "LSP" is displayed.
	Press the Set button 4 times until "dP" is displayed. 0 = No decimal point, 1 = One decimal point.
	Press the AT button to select the digit.
	Press the Up or Down button to change the value.
	Press the Set button to save the new value.
	Press and hold the Set button to exit the setting mode.

F-76002-2 REV. C

MYPIN TEMPERATURE CONTROLLER WIRING AND SETTING CONVEYOR DRYERS

The second parameter mode allows you to adjust the operating values of the controller. Note these values are the default values and some will change once you install the dryer. Follow the Auto-tuning instructions.

	Press and hold the Set buttons until "AL1" is displayed.
	Press the Set button to advance to the next setting.
	To change the current setting value, press and release the AT button and the far right digit will flash. You can select another digit by pressing the AT button again.
	To change the value of the flashing digit press the UP or Down button.
	Press the Set button to save the new value.
	Press and hold the Set button to exit the setting mode.

AL1	Alarm 1 set range – 0000-9999 Controller shuts down if over this Temp. 450	oUd	Control direction HEAT
A_3	Alarm 1 mode: 2 = Absolute value HI alarm	HYS	Control Hysteresis - not used 00
AL2	Alarm 2 set range – 0000-9999 OUT2/AL2 LED is on until temp is above low limit. 80	CtL	Output Cycle Time - This is time in seconds the controller will cycle the output device to the heaters. (Solid State Relay) 05
A_2	Alarm 2 mode: 3 = Absolute value LOW alarm	trL	Low Analog Output – not used 0.00
PVF	Display Offset value. Displayed value = measured value – PVF If another device is used to measure the temp in the oven this value is the offset the display shows. = ±100 00	trH	High analog Output – not used 0.0
InP	Thermocouple type J	bSL	Temperature control method Pid
P	Proportional Band – 0.1-3600 or off 0.20	C - f	Temperature Unit F
I	Integral time range – 0.1-3600 or off 160.0	LCK	Parameter Lock Code 000 = Unlock, 010 = Locked
d	Derivative time range – 0.1-3600 or off 40		

AUTO-TUNING

It is best to Auto-Tune from a cold start.

	Press and HOLD the AT button until the AT LED turns on. The controller program will monitor and adjust the PID settings. The LED will remain ON until the process is finished then the LED will turn OFF.
-------------------------------------------------------------------------------------	--------------------------------------------------------------------------------------------------------------------------------------------------------------------------------------------------------------

F-76002-Z REV. C

Parts List



Part Number	Description
76003	Power Switch
76194	Speed Control Board
76198	Speed Control Resistor
390978	Speed Control Potentiometer
76195	Speed Control Knob
76005	Fan 230V
20603R	Heating Element 230V
20428	ThermoCouple
390981	Belt Drive Motor
74-1027-6	Belt
75024	Bearing
30-1283	Relay
80044	Drive Sprocket
80045	Driven Sprocket
75413	Connector Link
39-2249	Plug, Male Nema L6-30P

For more extensive parts and trouble shooting help with ANY Workhorse Product please visit our on-line Parts store and

Support Center at:

<http://support.workhorseproducts.com/store/>

Limited Warranty



Although every effort has been made to provide accurate specifications, Workhorse Products does not assume any liability for damages, whether consequential or incidental, that may result from the use or misuse of the indicated specifications. Workhorse Products requires the use of a licensed industrial electrician for the installation of electrical service to equipment requiring electrical power.

Workhorse Products reserves the right to alter specifications in the manufacture of its products. It is understood and agreed that Seller's liability for any equipment whether liability in contract, in tort, under any warranty, in negligence, in strict liability or otherwise shall not exceed the return of the amount of the purchase price paid by Buyer. Notwithstanding the foregoing provision, under no circumstances shall Seller be liable for special, indirect or consequential damages. The price stated for the equipment is a consideration in limiting Seller's liability. No action regardless of form, arising out of the transactions under this Agreement may be brought by Buyer more than one (1) year after the cause of action has occurred. Our warranty is specified is exclusive and no other warranty, whether written or oral, is expressed or implied. Workhorse Products specifically disclaims the implied warranties of merchantability and fitness for a particular purpose. Equipment manufactured or sold by Workhorse Products is warranted against defects in workmanship and materials for a period of one year from receipt by customer. All warranties initiate from date of shipment to original customer. Replacement parts are covered for the term of the equipment warranty period. Parts not under warranty are covered for thirty (30) days from receipt by customer. Any part found by Workhorse Products to be defective in material or workmanship within the stated warranty period will be replaced or repaired at Workhorse's option without charge.

AFTER OBTAINING AN RMA# SEND RETURNED FREIGHT PREPAID TO 3730 E. Southern Avenue, PHOENIX, AZ 85040 USA.

Written authorization must be obtained from Workhorse before any part will be accepted. Replacement parts are sent out freight collect.

Parts sent out prior to receiving defective require a credit card hold for cost plus freight. Upon return of defective part, if it is deemed that the part was not damaged by customer but failed, the cost of the replacement part will be refunded.

This warranty does not extend to expendable parts such as filters, fuses, elements and brushes. Workhorse does not warrant failure of parts or components resulting from misuse or lack of proper maintenance. Installation, inspection, and

Registration Form	
Company Name: _____	Contact Name: _____
Address: _____	Phone Number: _____
_____	Fax Number: _____
City: _____	Email : _____
State: _____	Cell Number: _____
Country: _____	Serial Number: _____
Zip Code: _____	Date Recivied: _____
Model Number: _____	
Date Purchased _____	

Please Fax Registration Form for warranty to take place