

Thoughtfully Designed For Your Success

Complete Range of High-Performance
Office Furniture Solutions



OFFICE
FURNITURE

 **Nilkamal**[®]
EDGE[™]

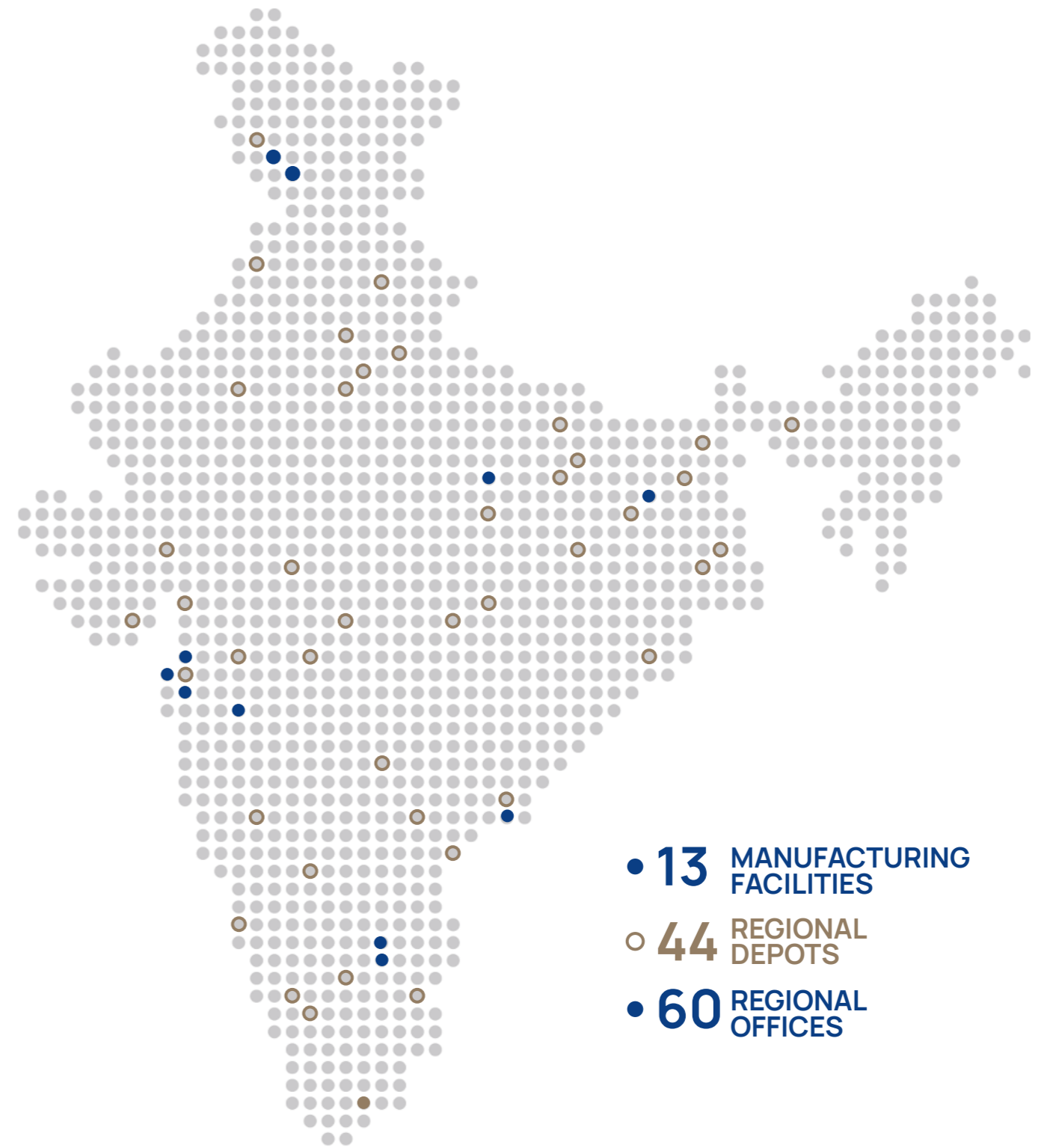

- **13** MANUFACTURING FACILITIES
- **44** REGIONAL DEPOTS
- **60** REGIONAL OFFICES

PRESENCE ACROSS 60+ CITIES IN INDIA:

Ahmedabad | Aurangabad | Indore | Jabalpur | Uran Dc | Nagpur | Raipur | Pune | Gwalior | Surat | Vasona | Akola |
Bhaglpur | Bhubaneshwar | Guwahati | Patna | Ranchi | Sambalpur | Barjora | Kolkata | Siliguri | Delhi | Dharuhera |
Haridwar | Jaipur | Punjab | Noida | Varanasi | Bareilly | Jammu | Kanpur | Bangalore | Kochi | Hubli | Hyderabad |
Trichy | Vijaywada | Pondicherry | Coimbatore | Chennai | Hosur | Calicut | Ongole | Tuticorin

 **Nilkamal**[®]
EDGE[™]

Head office: Nilkamal Limited, Nilkamal House, Plot No. 77/78, Street No.14,
MIDC, Andheri (E), Mumbai - 400 093 | Tel: 022 4235 8503 | Toll Free No: 1800 121 9115
Email: enquiry@nilkamaledge.com | www.nilkamaledge.com



About Us.....	02
Desking Solutions.....	04
Optimize Workstation.....	06
Grace Workstation.....	16
Transform+ Workstation.....	28
Executive Desk.....	40
Managers Desk.....	44
Staff Desk.....	48
Conference Table.....	54
Seating Solutions.....	60
Executive Office Chairs.....	62
Task Office Chairs.....	74
Visitor Series Office Chairs.....	90
Training Chair.....	96
Public Seating.....	100
Auditorium Seating.....	102
Storage Solutions.....	104
Cafeteria Solutions.....	118
Breakout Zone Furniture.....	132

THOUGHTFULLY DESIGNED



Maximise productivity with Nilkamal EDGE furniture solutions thoughtfully designed by an in-house dedicated team of experts after detailed understanding of ergonomics to promote healthy posture. Our solutions are designed to deliver:

- Enhanced Ergonomics - Suited to create healthy posture and ensure high productivity at work
- Elevated design – Vibrant designs that are perfect for modern and high-performance workplaces
- Customisable solutions – Our team of architects and designers collaborate with your teams to create workspaces that work for you.

CERTIFIED QUALITY

Our Office Furniture Solutions Undergo Rigorous Quality Testing From Raw Materials To Packaging In Our State-of-the-art Laboratories. All Our Products Are Certified By Leading Institutions To Meet The Highest Quality And Safety Standards.



ISO9001:2015



ISO14001:2015



ISO 45001:2018



ISO50001:2018

BIFMA LEVEL 3

AIOTA

GreenGUARD

MANUFACTURING EXCELLENCE



Nilkamal Is Known For World Class Manufacturing. Our State-of The Art Manufacturing Facilities Are Accomplished With Latest International Technology To Deliver High Quality Furniture Solutions Across Materials Like

- Wood
- Metal
- Fabric
- Plastic.

AWARDS



FROST & SULLIVAN
WITH ECONOMICS TIMES
FOR EXCELLENCE IN MANUFACTURING



G.O.I AWARD
FOR ENERGY MANAGEMENT



CII AWARD
EXCELLENCE IN
ENERGY MANAGEMENT



OPTIMIZE WORKSTATION

Designed for Maximum Space Utilisation

The **Optimize Workstation Range** offers versatility and style for offices. It includes shared and individual workstations, cabins, and conference rooms. Optimize's minimalist design suits any office decor, with customization options for finishes and storage. Ideal for single projects or multi-site offices, it ensures a productive workspace.

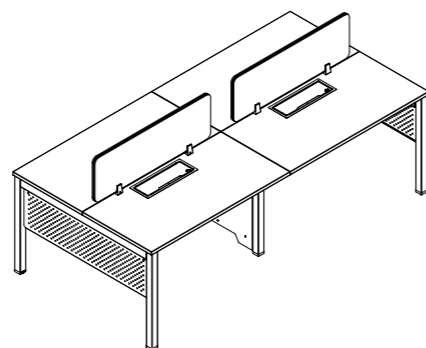

LINEAR WORKSTATION



Efficient Space Utilization:
Linear workstations are excellent for optimizing space and accommodating multiple employees in a compact area.

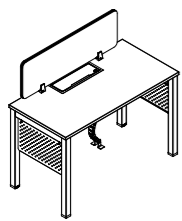

Linear Non-Sharing 1-PAX Seating with Side Modesty & Straight Metal Legs

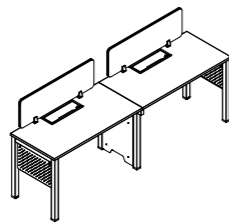

Linear Non-Sharing 2-PAX Cluster with Side Modesty & Straight Metal Legs

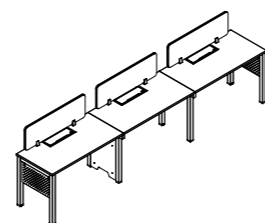

Linear Non-Sharing 3-PAX Cluster with Side Modesty & Straight Metal Legs

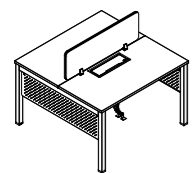

Linear Sharing (Back-to-Back) 2-PAX Cluster with Side Modesty & Straight Metal Legs

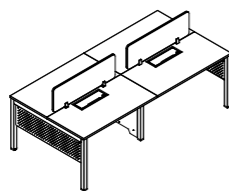

Linear Sharing (Back-to-Back) 4-PAX Cluster with Side Modesty & Straight Metal Legs

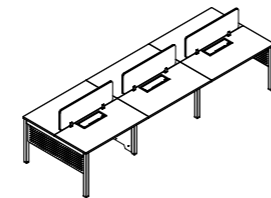

Linear Sharing (Back-to-Back) 6-PAX Cluster with Side Modesty & Straight Metal Legs

RETURN WORKSTATION



Ergonomics:
L-shaped design facilitates better organization and ergonomic desk setups.

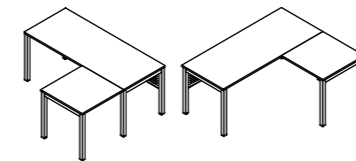

Non-Sharing 1-PAX Seating with RHS Return Worktop & Straight Metal Legs

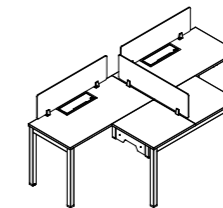

T-Shaped Sharing 2-PAX Cluster with Return Worktop & Straight Metal Legs

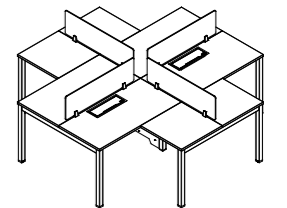

+ Shaped Sharing 4-PAX Cluster with Return Worktop & Straight Metal Legs

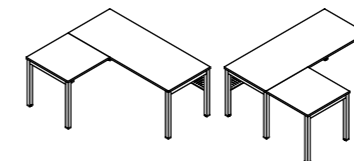

Non-Sharing 1-PAX Seating with LHS Return Worktop & Straight Metal Legs

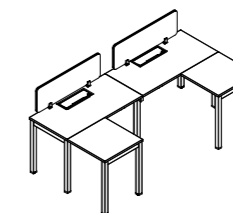

U-Shaped Sharing 2-PAX Cluster with Return Worktop & Straight Metal Legs

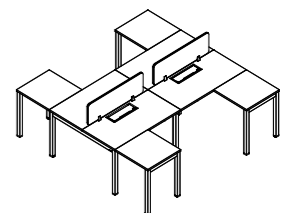

I-Shaped Sharing 4-PAX Cluster with Return Worktop & Straight Metal Legs

CURVILINEAR WORKSTATION



Reduced Distractions:
Provide a semi-private environment that minimizes interruptions.

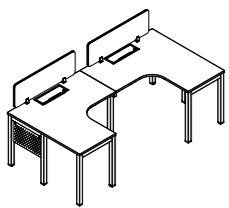

U-Shaped Sharing 2-PAX Cluster with Curvilinear (Round User Clearance) Worktop

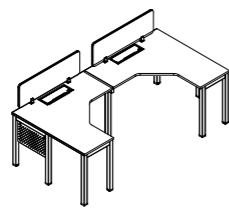

U-Shaped Sharing 2-PAX Cluster with Curvilinear (Chamfered User Clearance) Worktop

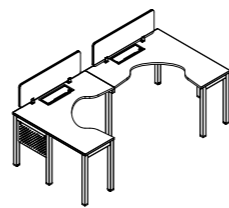

U-Shaped Sharing 2-PAX Cluster with Curvilinear (Deep User Clearance) Worktop

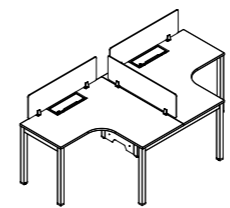

T-Shaped Sharing 2-PAX Cluster with Curvilinear (Round User Clearance) Worktop

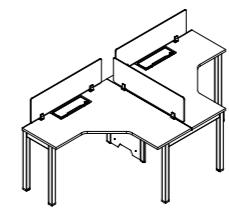

T-Shaped Sharing 2-PAX Cluster with Curvilinear (Chamfered User Clearance) Worktop

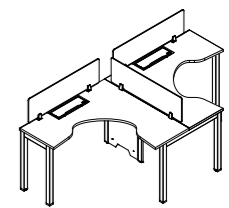

T-Shaped Sharing 2-PAX Cluster with Curvilinear (Deep User Clearance) Worktop

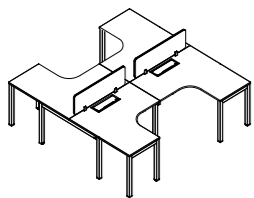

I-Shaped Sharing 2-PAX Cluster with Curvilinear (Round User Clearance) Worktop

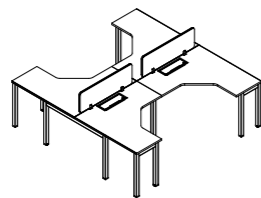

I-Shaped Sharing 2-PAX Cluster with Curvilinear (Chamfered User Clearance) Worktop

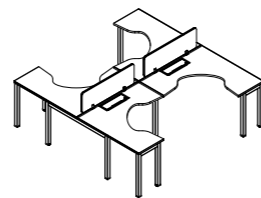

I-Shaped Sharing 2-PAX Cluster with Curvilinear (Deep User Clearance) Worktop

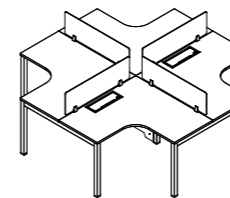

+ Shaped Sharing 2-PAX Cluster with Curvilinear (Round User Clearance) Worktop

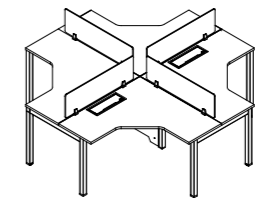

+ Shaped Sharing 2-PAX Cluster with Curvilinear (Chamfered User Clearance) Worktop

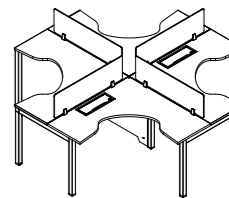

+ Shaped Sharing 2-PAX Cluster with Curvilinear (Deep User Clearance) Worktop

CABIN DESK



Leadership:
Signifies leadership within the organization, providing an inspiring space for decision-makers.

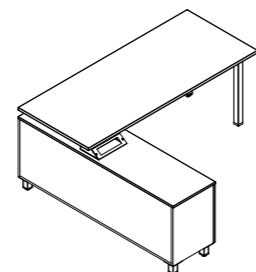
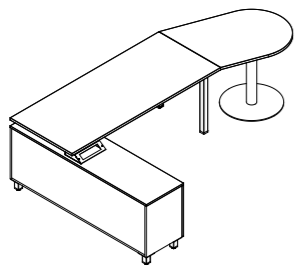
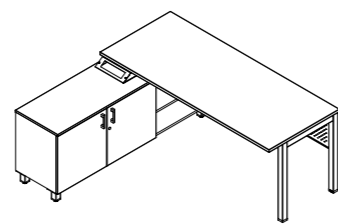
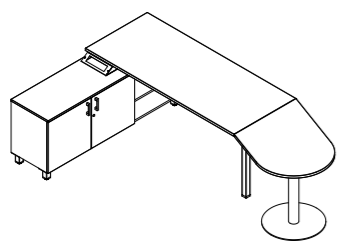

Private Cabin with Extended Return Worktop
(*Storage Below Return Worktop)

Private Cabin with Return Worktop
(*Storage Below Return Worktop)

CONFERENCE TABLE



Collaborative Meetings:
Large surface area allows for productive team meetings and discussions

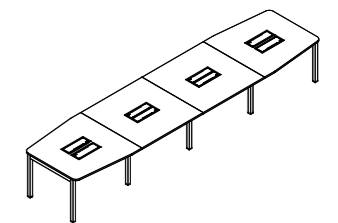
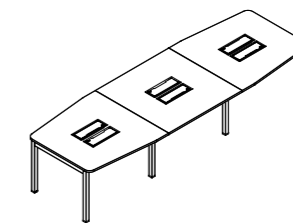
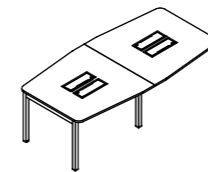

4-PAX Boat Shaped Conference Table with Straight Metal Legs

6-PAX Boat Shaped Conference Table with Straight Metal Legs

8-PAX Boat Shaped Conference Table with Straight Metal Legs

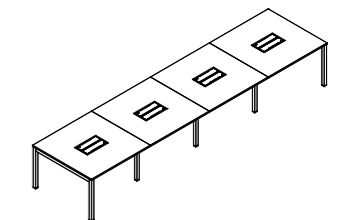
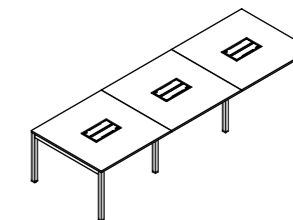
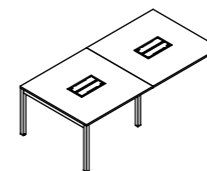

4-PAX Straight Conference Table with Straight Metal Legs

6-PAX Straight Conference Table with Straight Metal Legs

8-PAX Straight Conference Table with Straight Metal Legs

WORKSTATION RANGE

Power Access Cut-out

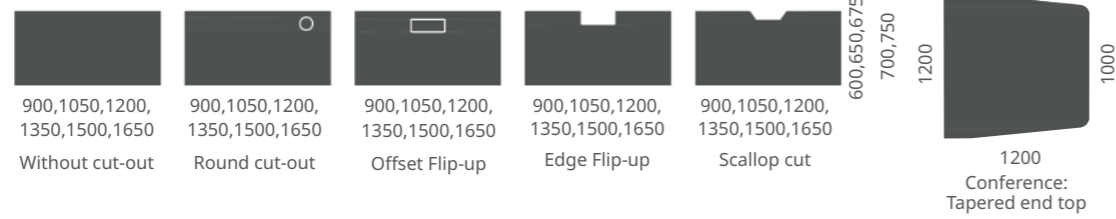

Curvilinear Worktop Profile

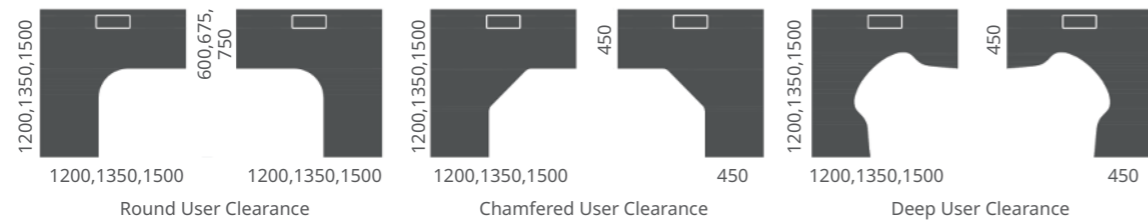

End Leg

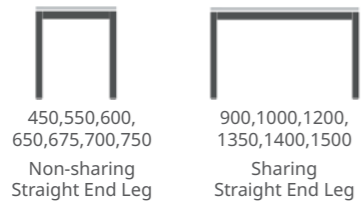

Vertical Duct



Mid Leg

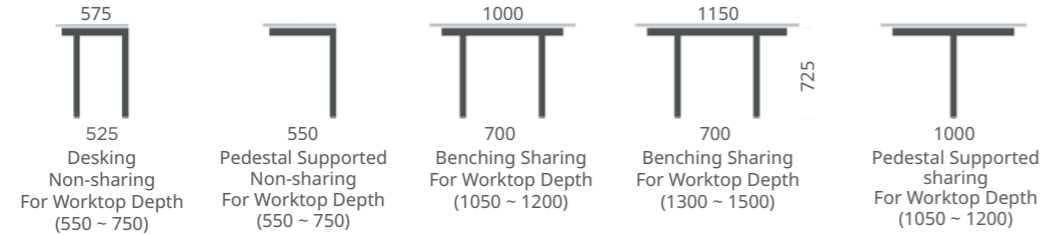

Desking workstation (Non-Sharing one side)

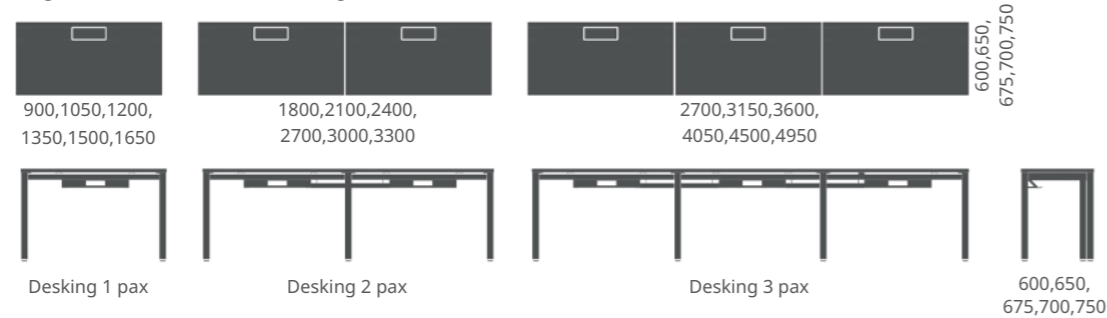

Benching workstation/Conference (Sharing-back to back)

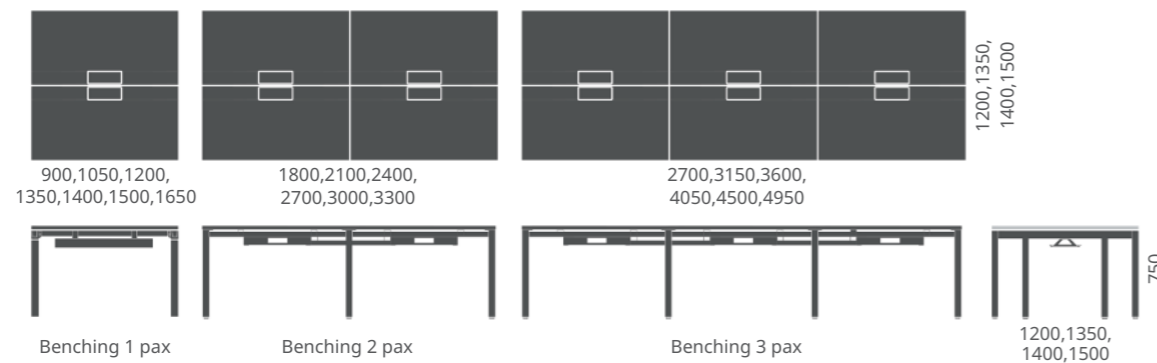

Benching workstation/Conference (Sharing-back to back) - Boat shaped

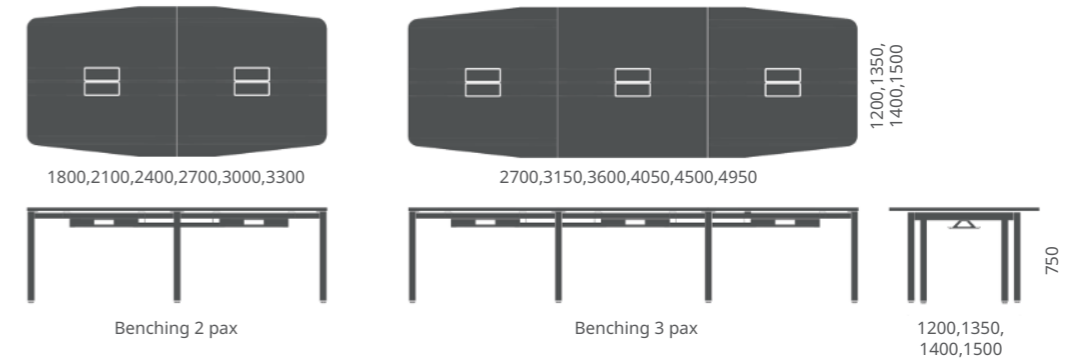

Return Worktop

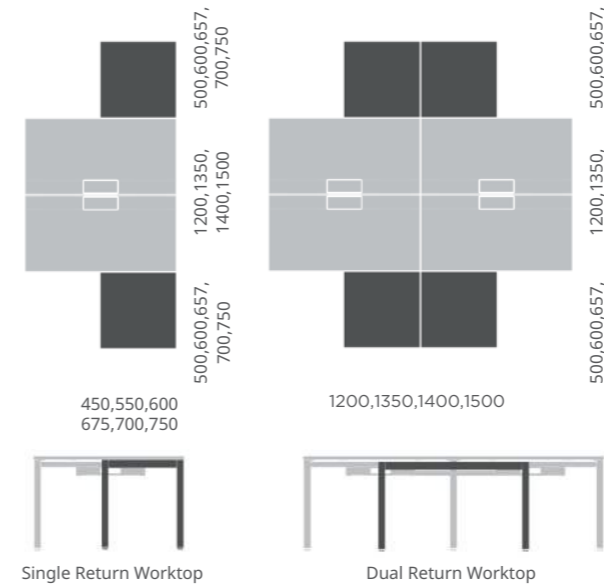

Private Cabin with Return worktop / *with return storage below worktop

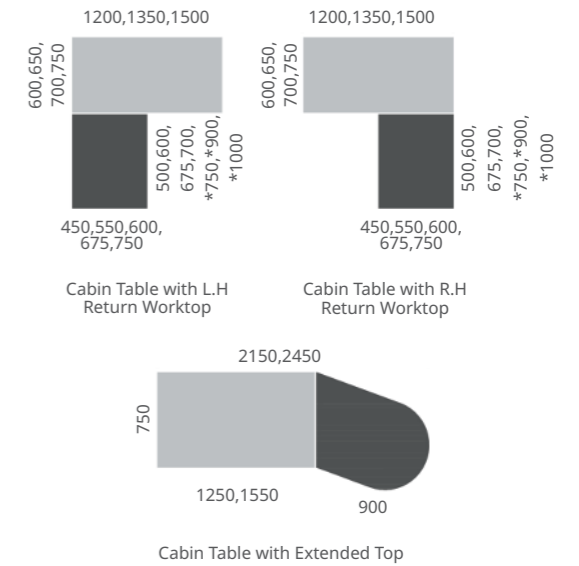

Curvilinear Worktop

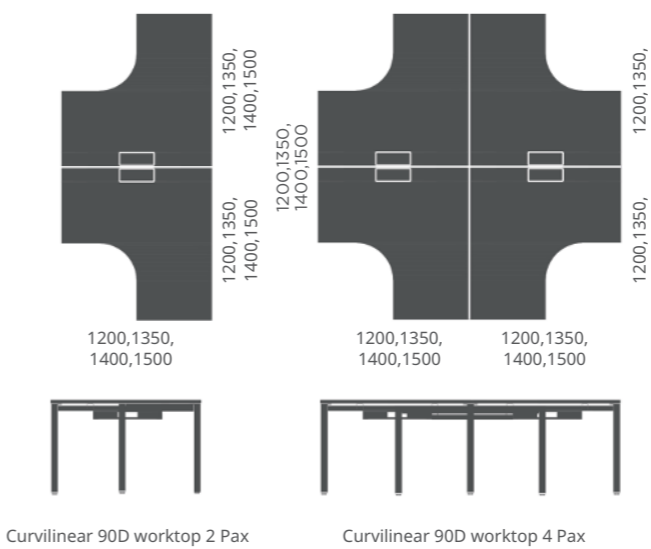

Private Cabin with Single Worktop

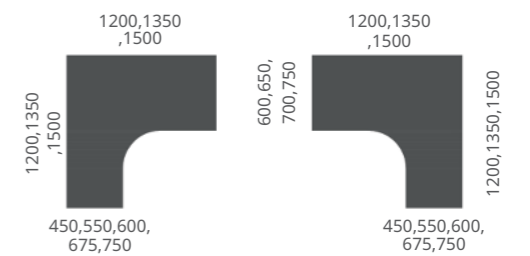

GRACE WORKSTATION

Slant Leg Design for Enhanced Aesthetics

The **Grace Workstation Range** with slant legs offers versatility and style for any office. With various configurations, including shared and individual workstations, cabins, and conference rooms, Grace can be customized to suit your business needs. Its sleek design and sturdy construction create a professional and inviting workspace, making it ideal for individual offices or collaborative meeting spaces.

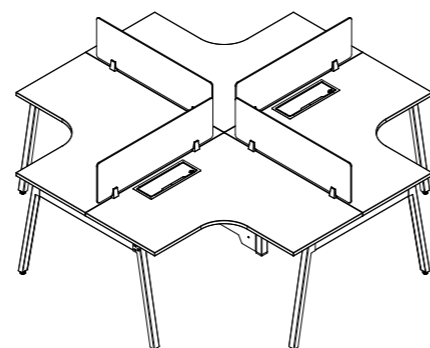

LINEAR WORKSTATION



Open Collaboration:
Promote open communication and collaboration among team members in a shared workspace.

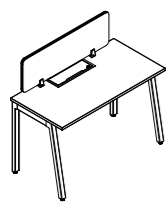

Linear Non-Sharing 1-PAX Seating with Slant Metal Legs

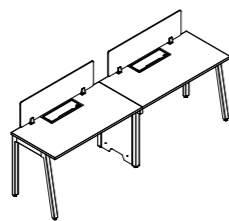

Linear Non-Sharing 2-PAX Cluster with Slant Metal Legs

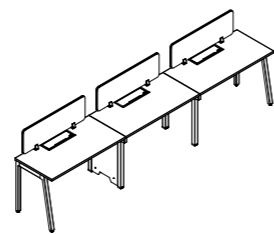

Linear Non-Sharing 3-PAX Cluster with Slant Metal Legs

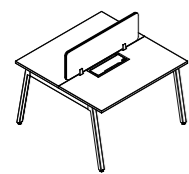

Linear Sharing (Back-to-Back) 2-PAX Cluster with Slant Metal Legs

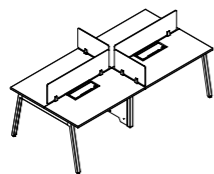

Linear Sharing (Back-to-Back) 4-PAX Cluster with Slant Metal Legs

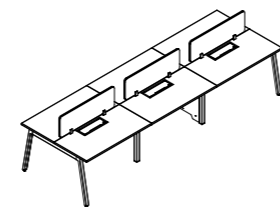

Linear Sharing (Back-to-Back) 6-PAX Cluster with Slant Metal Legs

RETURN WORKSTATION



Space Optimization:
Efficiently uses corner spaces or smaller areas, maximizing office layout possibilities.

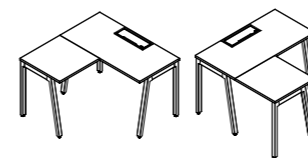

Non-Sharing 1-PAX Seating with LH Return Worktop & Slant Metal Legs

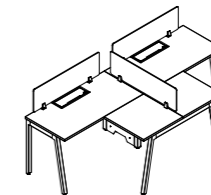

T-Shaped Sharing 2-PAX Cluster with Return Worktop & Slant Metal Legs

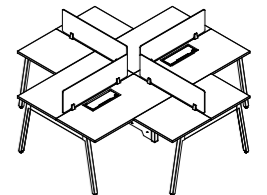

+ Shaped Sharing 4-PAX Cluster with Return Worktop & Slant Metal Legs

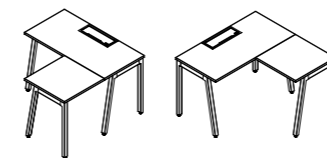

Non-Sharing 1-PAX Seating with RHS Return Worktop & Slant Metal Legs

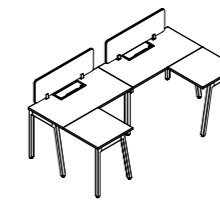

U-Shaped Sharing 2-PAX Cluster with Return Worktop & Slant Metal Legs

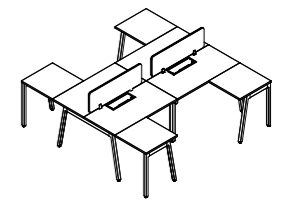

I-Shaped Sharing 4-PAX Cluster with Return Worktop & Slant Metal Legs

CURVILINEAR WORKSTATION



Aesthetics:
Offers a modern and visually appealing design, enhancing the overall office aesthetics.

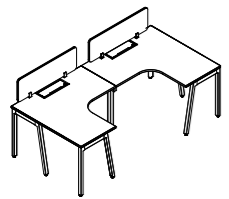

U-Shaped Sharing 2-PAX Cluster with Curvilinear (Round User Clearance) Worktop

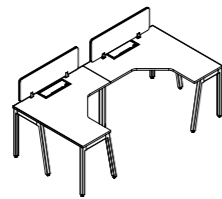

U-Shaped Sharing 2-PAX Cluster with Curvilinear (Chamfered User Clearance) Worktop

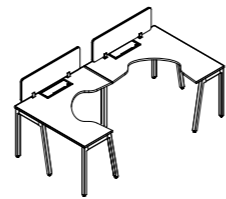

U-Shaped Sharing 2-PAX Cluster with Curvilinear (Deep User Clearance) Worktop

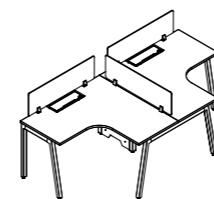

T-Shaped Sharing 2-PAX Cluster with Curvilinear (Round User Clearance) Worktop

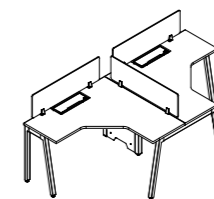

T-Shaped Sharing 2-PAX Cluster with Curvilinear (Chamfered User Clearance) Worktop

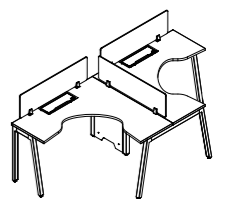

T-Shaped Sharing 2-PAX Cluster with Curvilinear (Deep User Clearance) Worktop

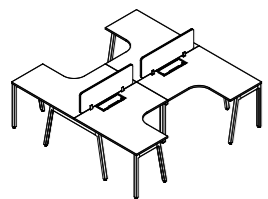

I-Shaped Sharing 2-PAX Cluster with Curvilinear (Round User Clearance) Worktop

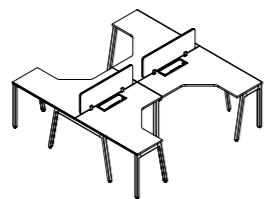

I-Shaped Sharing 2-PAX Cluster with Curvilinear (Chamfered User Clearance) Worktop

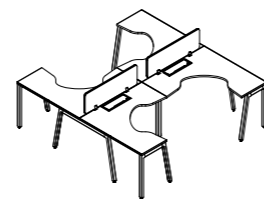

I-Shaped Sharing 2-PAX Cluster with Curvilinear (Deep User Clearance) Worktop

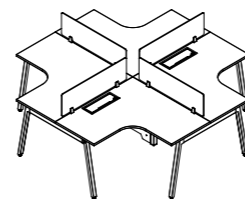

+ Shaped Sharing 2-PAX Cluster with Curvilinear (Round User Clearance) Worktop

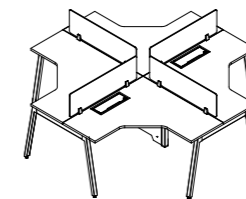

+ Shaped Sharing 2-PAX Cluster with Curvilinear (Chamfered User Clearance) Worktop

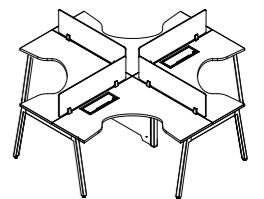

+ Shaped Sharing 2-PAX Cluster with Curvilinear (Deep User Clearance) Worktop

CABIN DESK



Executive Presence:
Provides an executive, professional look in private office settings.

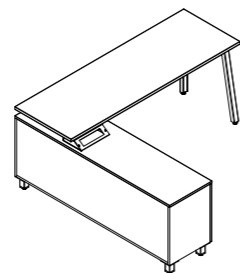
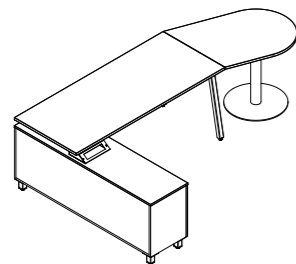
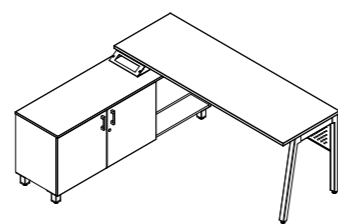
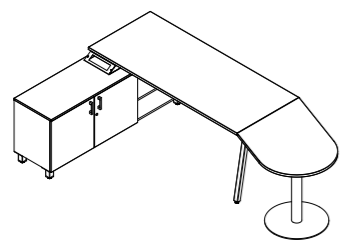

Private Cabin with Extended Return Worktop
(*Storage Below Return Worktop)

Private Cabin with Return Worktop
(*Storage Below Return Worktop)

CONFERENCE TABLE



Versatile Seating:
Accommodates a variety of seating arrangements to suit different meeting styles.

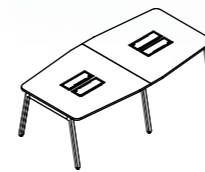

4-PAX Boat Shaped Conference Table with Slant Metal Legs

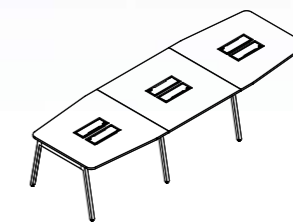

6-PAX Boat Shaped Conference Table with Slant Metal Legs

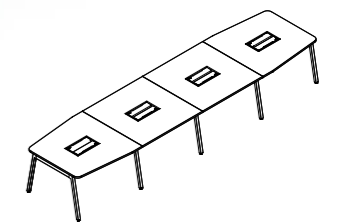

8-PAX Boat Shaped Conference Table with Slant Metal Legs

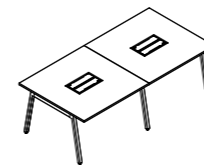

4-PAX Straight Conference Table with Slant Metal Legs

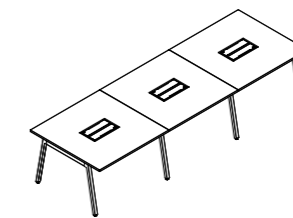

6-PAX Straight Conference Table with Slant Metal Legs

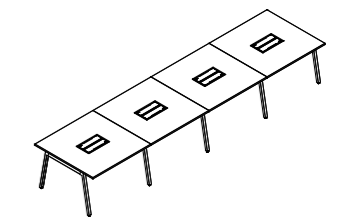

8-PAX Straight Conference Table with Slant Metal Legs

WORKSTATION RANGE

Power Access Cut-out

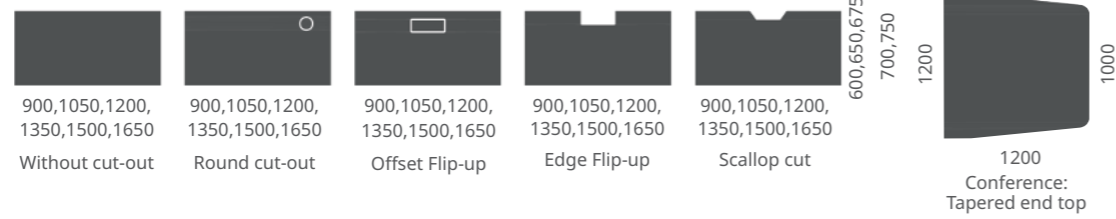

Curvilinear Worktop Profile

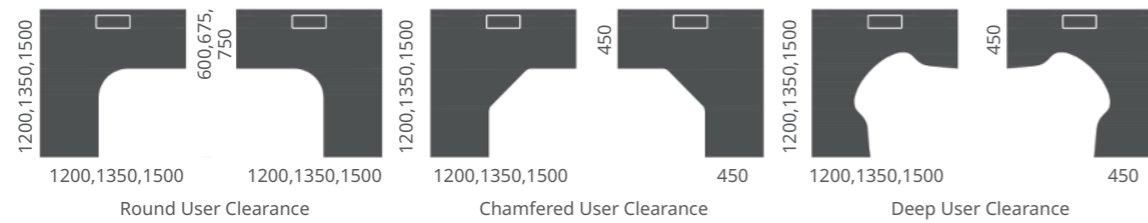

End Leg

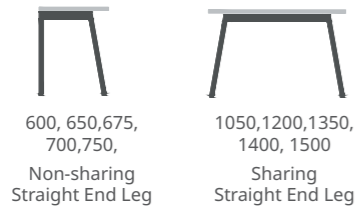

Vertical Duct



Mid Leg

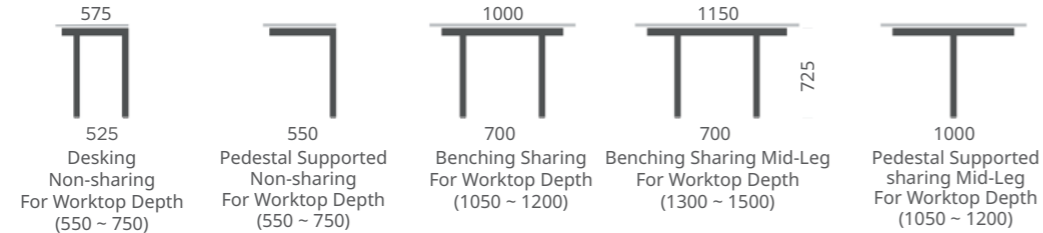

Desking workstation (Non-Sharing one side)

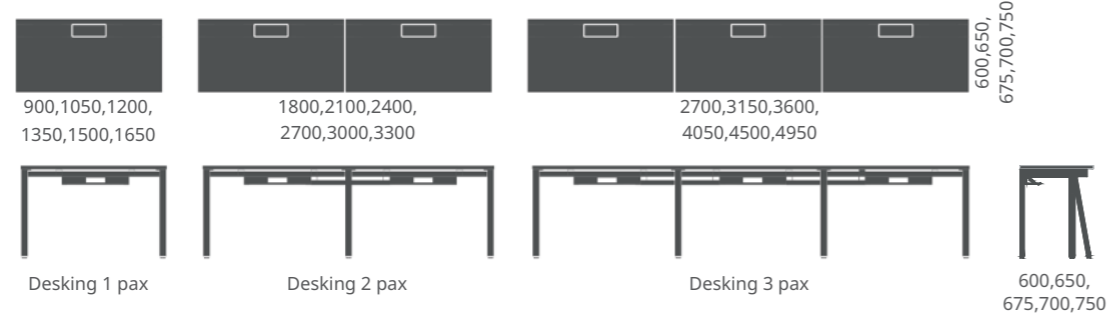

Benching workstation/Conference (Sharing-back to back)

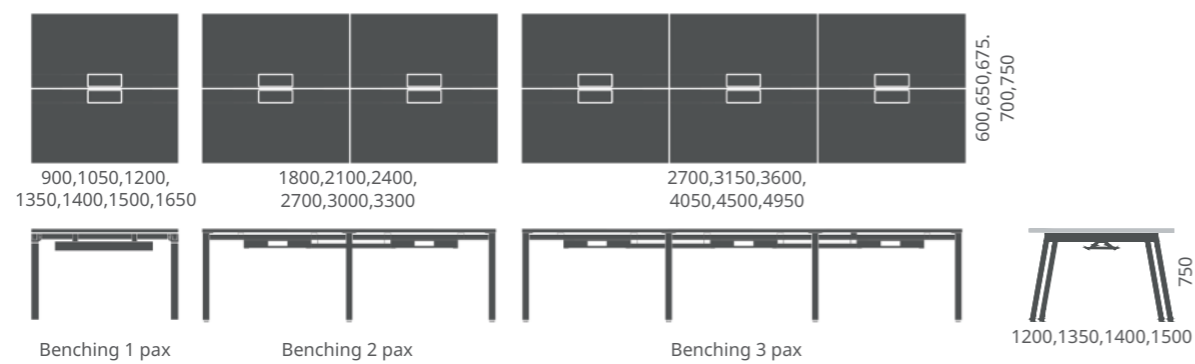

Benching workstation/Conference (Sharing-back to back) - Boat shaped

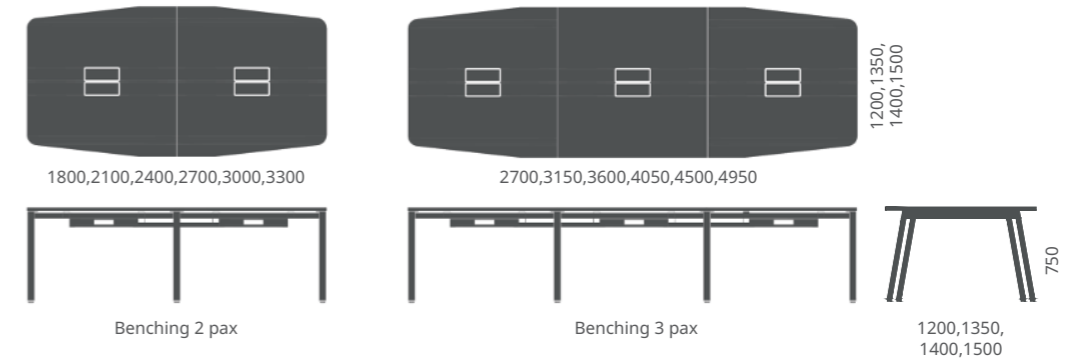

Return Worktop

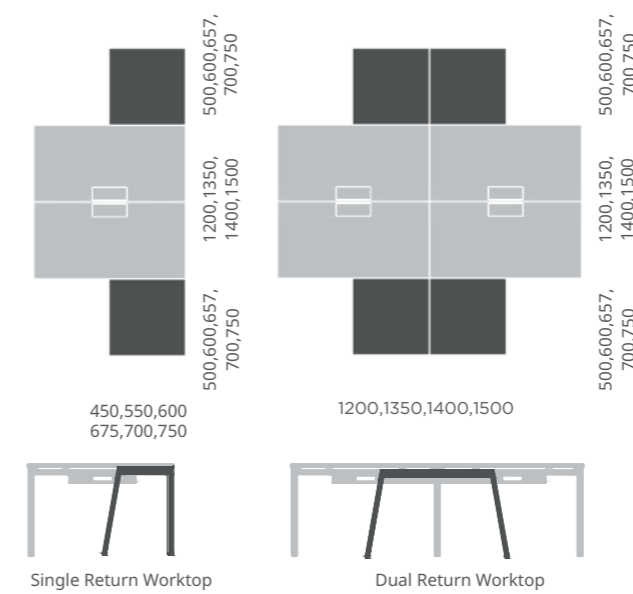

Private Cabin with Return worktop / *with return storage below worktop

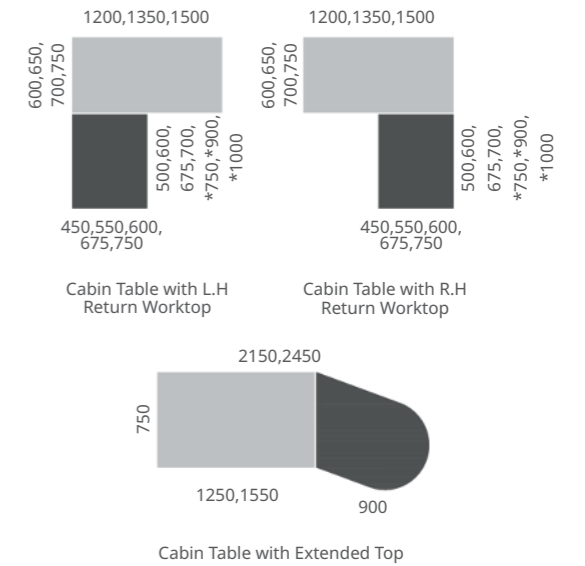

Curvilinear Worktop

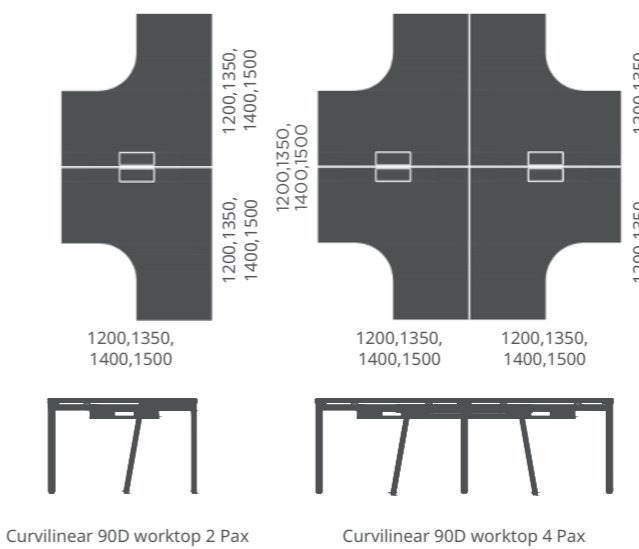

Private Cabin with Single Worktop

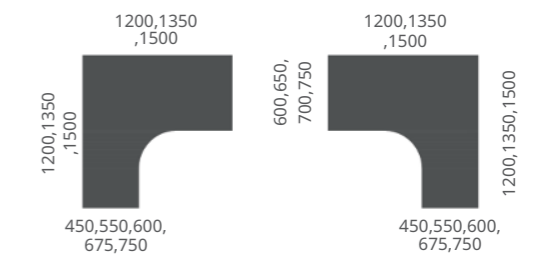

Screen & Storage Options

Center Screens - With Worksurface Bracket

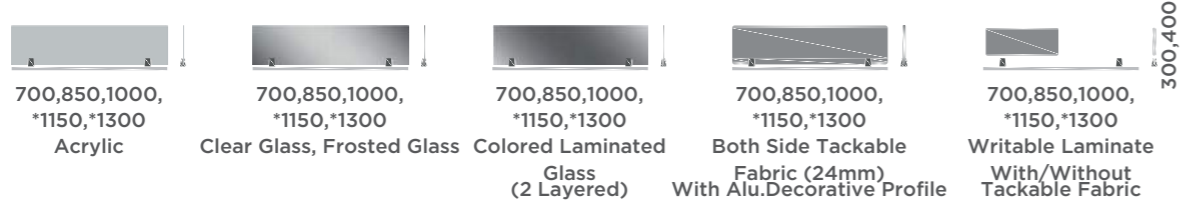

Center Screens with Thin Cut

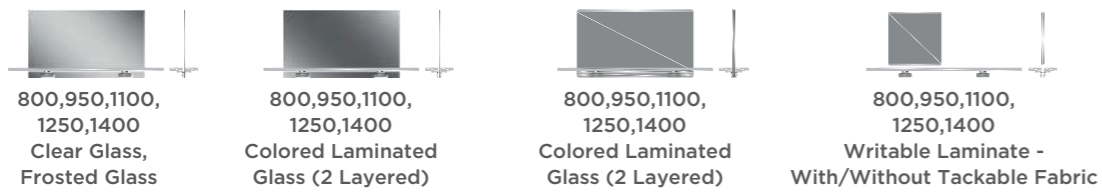

Center Screens with Accessory Rail

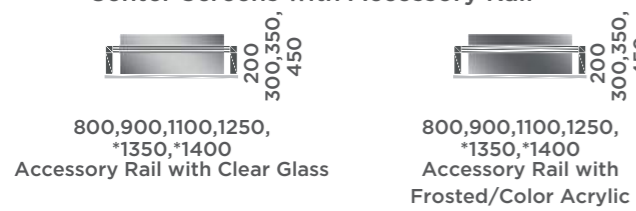

Pedestal

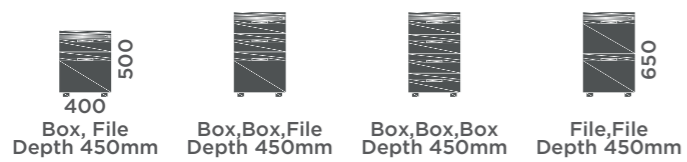

Side Storage

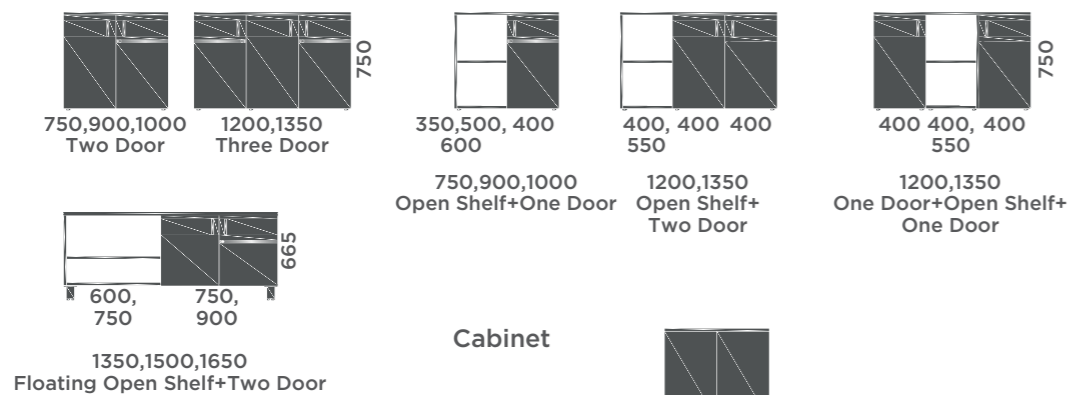

Cabinet

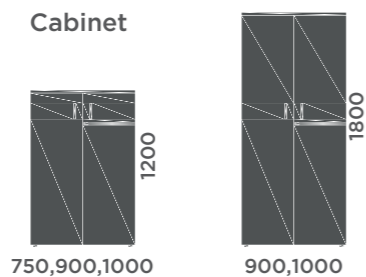

Intelligent Innovation



Accessories Rail



Side Screen



Aluminium Sliding Socket



Self Closing Flip Up



Suspended Cpu Holder



Stationery Tray



Odds End Tray



Name Plate



Pen Holder



Cup Holder

TRANSFORM + WORKSTATION

Designed To Enhance Acoustic Performance

Transform Plus offers a versatile workstation range suitable for both solo and collaborative work. Available in various configurations, it ensures comfort and productivity. Tailor layouts to individual, shared, or team workstations. Create quiet, distraction-free spaces. Whether for personal or team use, it's a cost-effective solution meeting your needs.

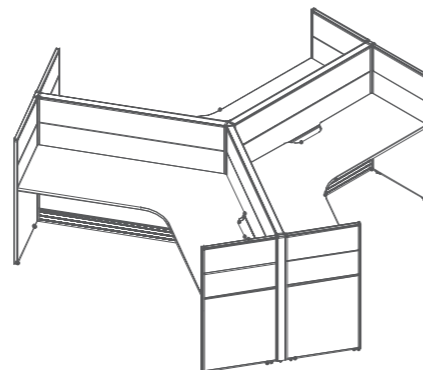

WORKSTATION RANGE

LINEAR WORKSTATION



Executive Presence:
Provides an executive, professional look in private office settings.

120° RETURN TABLE



Versatile Seating:
Accommodates a variety of seating arrangements to suit different meeting styles.

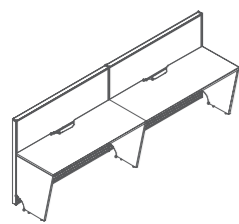

Non-sharing 2-Pax Cluster With Laminate Gable End

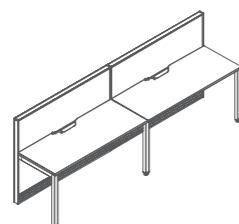

Non-sharing 2-Pax Cluster With Metal Leg

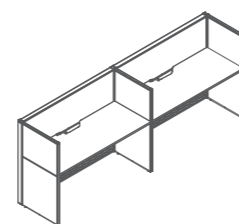

Non-sharing 2-Pax Cluster With 30mm Transform Panel

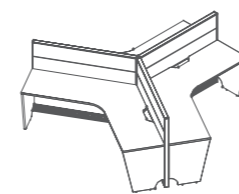

120° 3-Pax Cluster With Laminate Gable End

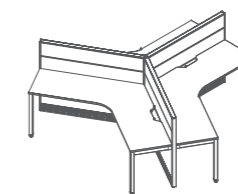

120° 3-Pax Cluster With Metal Leg

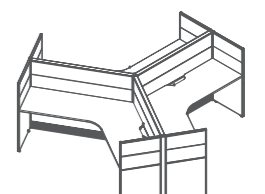

120° 3-Pax Cluster With 30mm Transform Panel

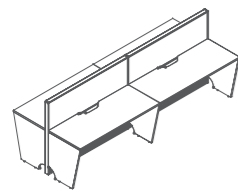

Sharing 4-Pax Cluster With Laminate Gable End

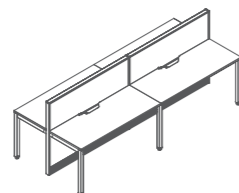

Sharing 4-Pax Cluster With Metal Leg

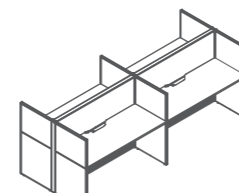

Sharing 4-Pax Cluster With 30mm Transform Panel

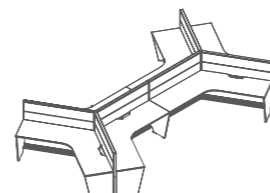

120° 6-Pax Cluster With Laminate Gable End

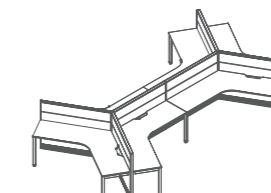

120° 6-Pax Cluster With Metal Leg

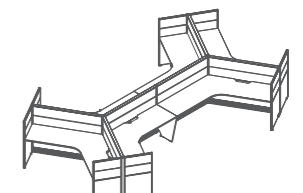

120° 6-Pax Cluster With 30mm Transform Panel

CURVILINEAR WORKSTATION



Reduced Distractions:
Provide a semi-private environment that minimizes interruptions.

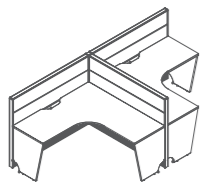

Curvilinear 2-Pax Cluster With Laminate Gable End T-Shaped

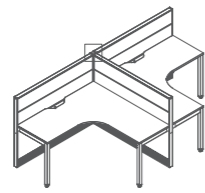

Curvilinear 2-Pax Cluster With Metal Leg T-Shaped

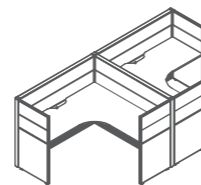

Curvilinear 2-Pax Cluster With 30mm Transform Panel T-Shaped

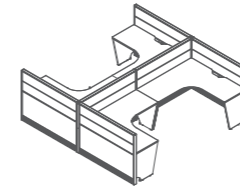

Curvilinear 4-Pax Cluster With Laminate Gable End C-Shaped

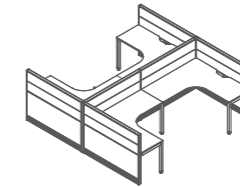

Curvilinear 4-Pax Cluster With Metal Leg C-Shaped

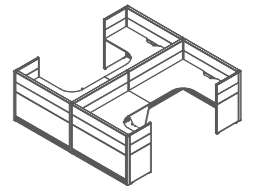

Curvilinear 4-Pax Cluster With 30mm Transform Panel C-Shaped

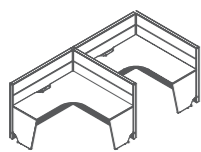

Curvilinear 2-Pax Cluster With Laminate Gable End

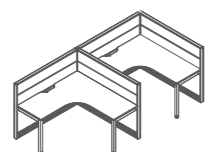

Curvilinear 2-Pax Cluster With Metal Leg

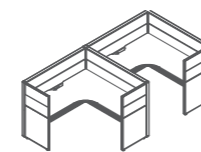

Curvilinear 2-Pax Cluster With 30mm Transform Panel

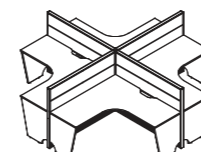

Curvilinear 4-Pax Cluster With Laminate Gable End Plus-Shaped

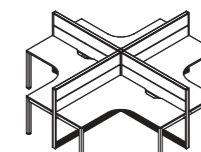

Curvilinear 4-Pax Cluster With Metal Leg Plus-Shaped

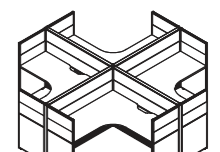

Curvilinear 4-Pax Cluster With 30mm Transform Panel Plus-Shaped

WORKSTATION RANGE

Panel Height Configuration

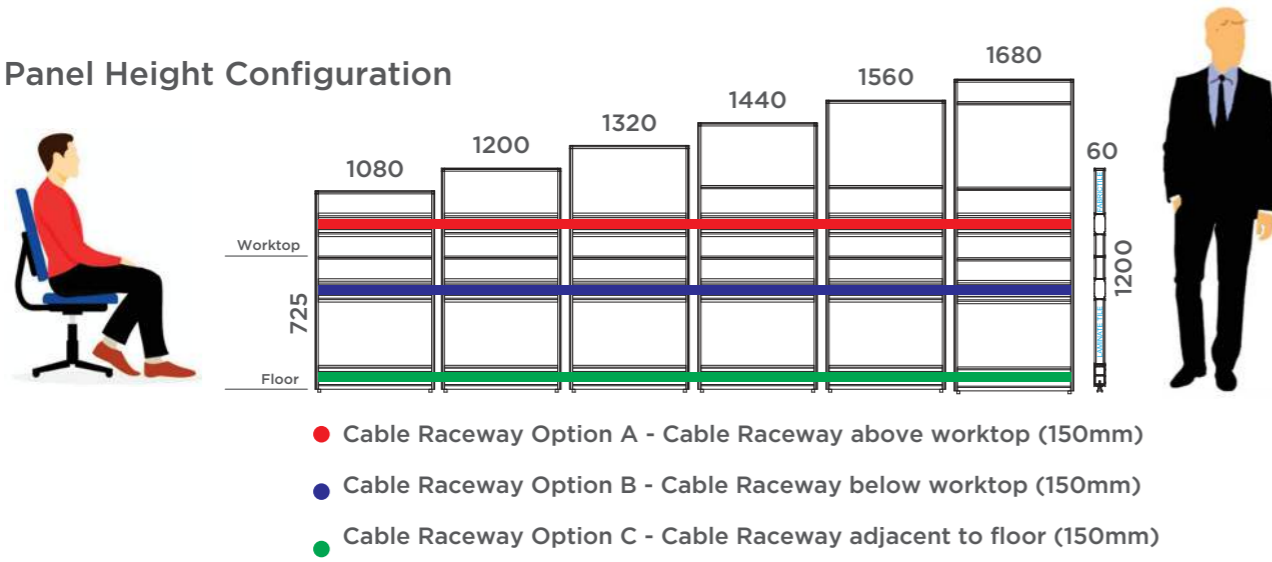

Cable Management

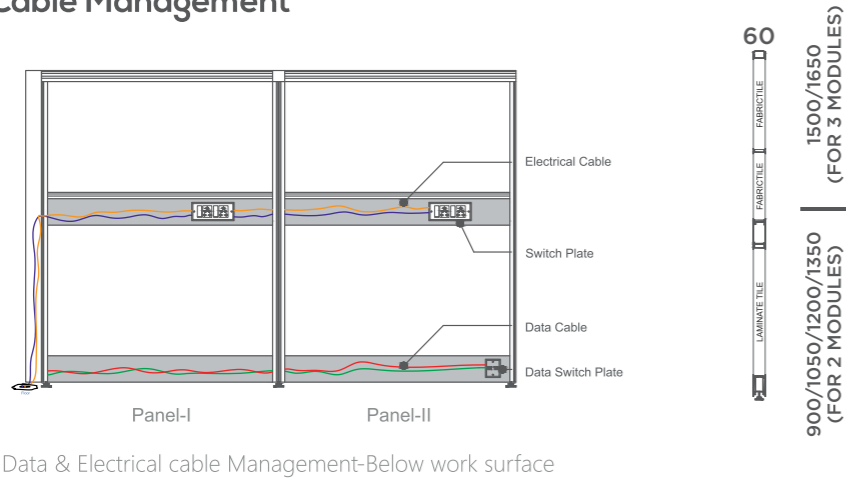

Finish Options

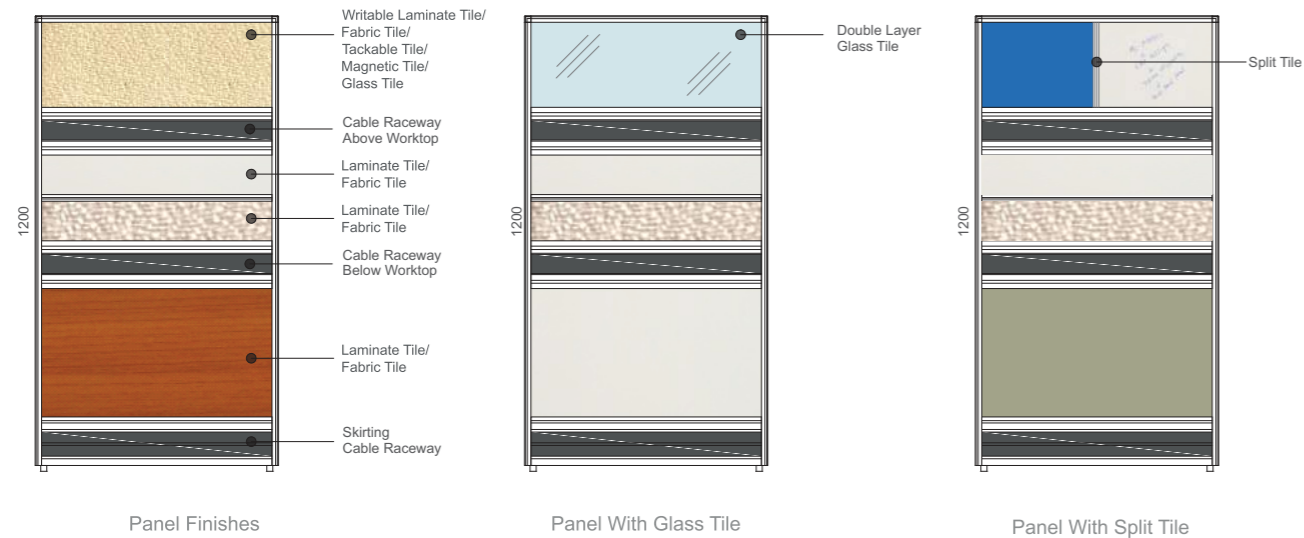

I 4pax Inline Cluster (Main 60mm Panel + Return 30mm Panel with Change of Ht.)



I 4Pax Inline Cluster (60mm Panel With Writing Surface + Return Panel 30mm)



I 4Pax Inline Cluster (60mm Panel With Change of Ht. + Return 30mm With Optimize Leg)



I 4pax Inline Cluster (60mm Panel With Overhead Storage Unit + Return Panel 30mm)



I 120° 3Pax Cluster (Main 60mm + Return 30mm Panel with Clear Glass)

SURFACE MATERIAL FINISHES

GLASS FINISHES



NKL
Clear Glass



NKL
Lemon Yellow



NKL
Electric Blue



NKL
Sky Blue



NKL
Energy Red



NKL
Titanium Orange



NKL
Jade White



NKL
Lime Burst

LAMINATE FINISHES



NKL
Classic Planked
Walnut



NKL
Frosty White



NKL
Thansu Maple



NKL
Highland Pine



NKL
Oxford Cherry



NKL
Graphite Gray



NKL
Silver Gray



NKL
Electric Blue



NKL
Acacia



NKL
Wenge

POWDER COATING FINISHES



NKL
Moonshell
Grey



NKL
Texture Moonlight
Grey



NKL
Graphite Grey



NKL
Prince Grey



NKL
White



NKL
Black



NKL
Simens Grey



NKL
Ivory



NKL
Ultra Blue



NKL
Deep Blue

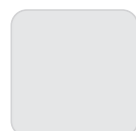

NKL
Telegrey

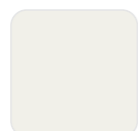

NKL
RAL 9010

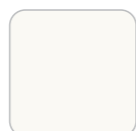

NKL
Pale White

SURFACE MATERIAL FINISHES

FABRIC FINISHES - FESTIVAL



NKL
Pearl



NKL
Purple



NKL
Waterfall



NKL
Salmon



NKL
Dago Orange



NKL
Dolphine

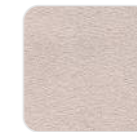

NKL
Clouds

FABRIC FINISHES - VIBRANT



NKL
V1030



NKL
V1003



NKL
V1021A



NKL
V1028



NKL
V1032



NKL
V1024



NKL
V1015

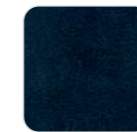

NKL
V1012

FABRIC FINISHES - MARS

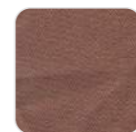

NKL
Carmel



NKL
Night Sky



NKL
411 Azazon



NKL
Blue



NKL
Flame



NKL
Granada



NKL
Oliva



NKL
Lemon



NKL
Relection



NKL
Baby Blue



NKL
Dolphine

HEIGHT ADJUSTABLE TABLE



Rise Height Adjustable Table



This Cutting-edge Height-adjustable Table Is Designed For Optimal Functionality, Ensuring Seamless Digital Adjustment, Robust Specifications, And Customizable Options For Diverse Office Needs.

Digital Height Adjustment With 4 Dedicated Memory Functions.

Specifications:

- Adjustable height range: 575-1255mm
- Extendable frame range: 1080-1800mm to fit various desk sizes
- Top size options: 1200-1800mm
- Foot size selection: 600mm or 700mm

Innovative Design:

- No-hole leg design, ensuring a sleek exterior with no visible screws.

Options:

- Compatible with all handsets
- Compatible with various styles of feet
- Bracket available for crossbar support.

Performance and Safety:

- Load capacity: 1200N
- Max speed: 40mm/s
- Low noise level: <50db with no-load condition
- Anti-collision safety protection
- Low standby power <0.1W

Standard Finishes:

- Powder coating in standard color: White (RAL9016)





Assert Cabin Set

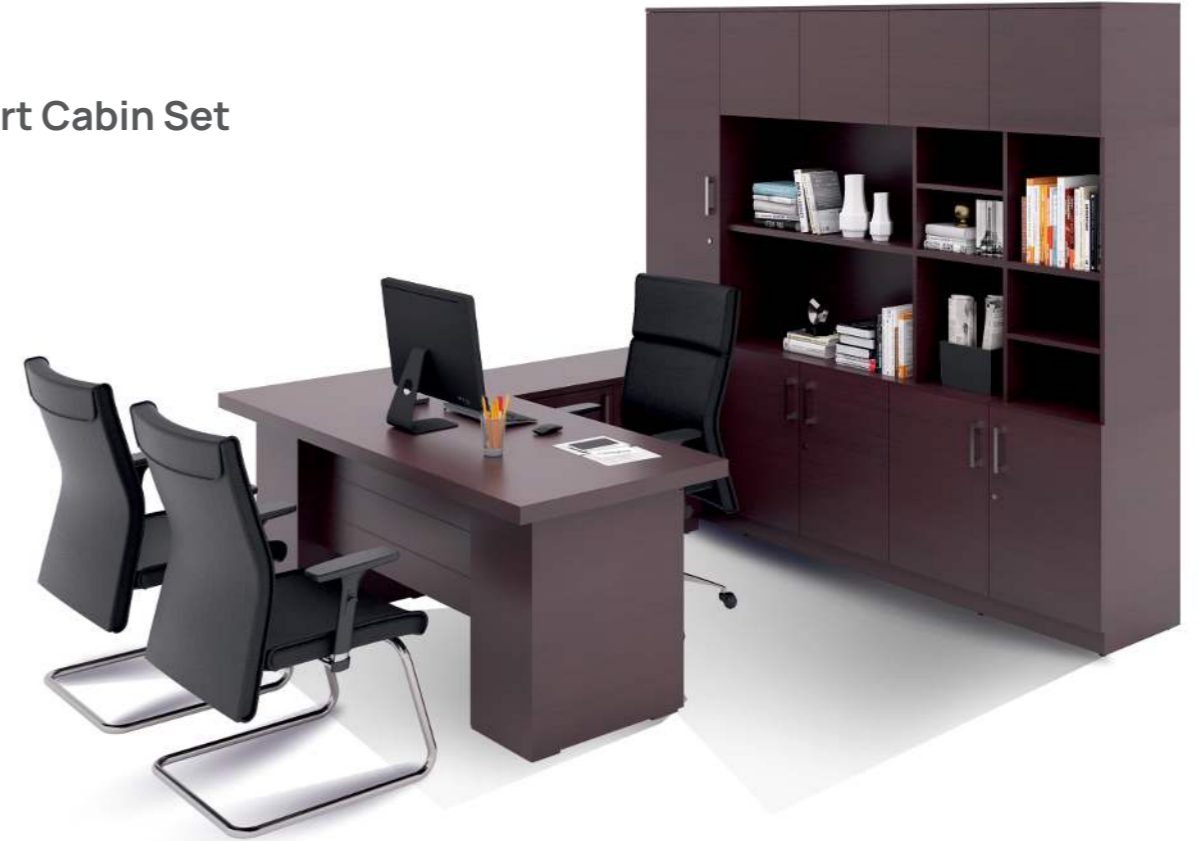

Discover Assert Cabin Tables—a perfect blend of durability, distinctive design, aesthetic enhancements, stability, and thoughtful cable management, elevating your workspace with style and functionality.

Quality Construction:

- Boasts an exceptionally durable and sturdy structure with robust reinforcement for added stability.
- Chrome-finished leveller plate not only contributes to aesthetics but also ensures stability.

Cable Management:

- Incorporates an intelligent cable management system for a neat and organized workspace.

Modular Structure:

- Fully knockdown design for easy assembly and adaptability to different configurations.

Structural Elements:

- Showcases a unique design and profile, featuring a substantial 50mm thick top for a solid worksurface.
- Aluminum fluted accents add a touch of sophistication to the overall design.

Standard Finishes:

- Available in Classic Walnut

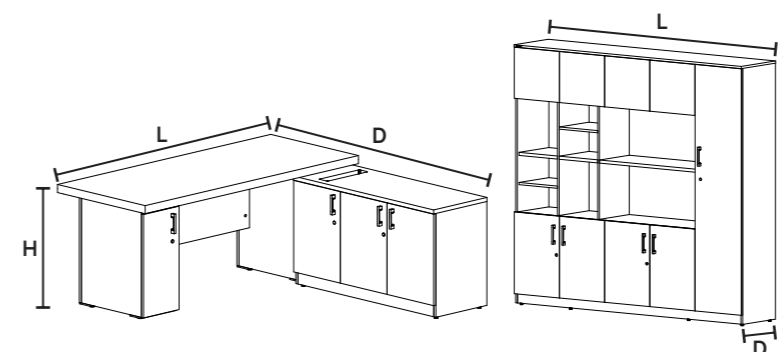

Dimensions

	Length	Depth	Height
Cabin Table (Main Table + Return Storage)	1800	1850	750
Main Table	1800	750	750
Return Storage	1300*	450	685*
Back Storage	1800	450	1800

All Dimension in mm

Executive Cabin Set



This Executive Desk set combines practicality with sophistication, featuring premium materials, structural integrity, and an elegant finish for a timeless office aesthetic.

Executive Desk Ensemble:

- Includes Executive Desk with Return, Back Storage, and Glass Door Tower Unit.
- Knock-down construction for easy assembly.

Premium Materials:

- 36mm thick post-laminated Particle Board top with matching edge band
- 18mm thick pre-laminated Particle Board modesty.

Structural Elements:

- Reinforcement below the top prevents sagging.
- Gable foot bracket made of steel with Nylon levelers.

Standard Finishes:

- Available in Classic Walnut & Thansu Maple.

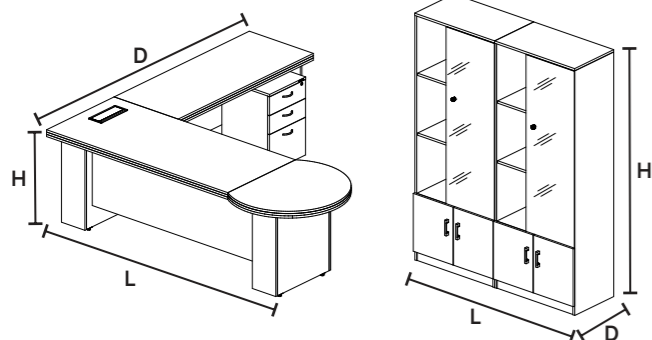
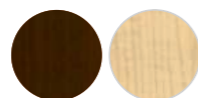

Dimensions

	Length	Depth	Height
Cabin Table	2400	2325	750
Back Storage	1500	450	1950

All Dimension in mm

Elegant Neo



Elegant Neo Executive Tables showcase premium construction, structural integrity, aesthetic enhancements, and thoughtful cable management for a refined and organized workspace.

Aesthetic Enhancements:

- The curved front of the table top adds a sophisticated touch.

Premium Materials:

- Utilizes 25mm thick pre-laminated Particle Board for the top.
- Ensures a polished finish with edge banding all around.

Structural Elements:

- Features knock-down construction for easy setup.
- 18mm thick pre-laminated Particle Board for product construction.
- Gable foot brackets made from steel with nylon levelers.
- Equipped with grommets on both sides for convenient and accessible cable management.

Standard Finishes:

- Available in Classic Walnut

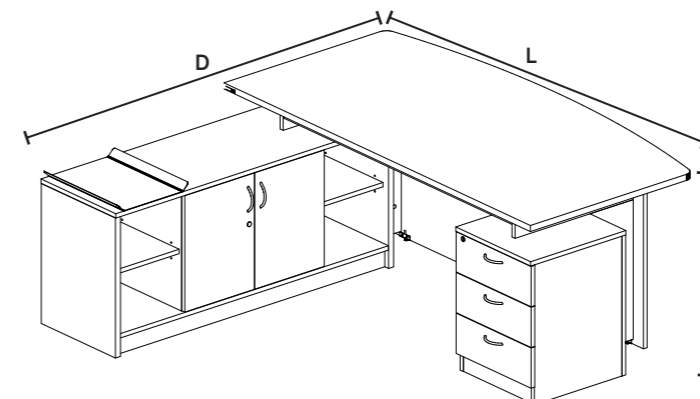

Dimensions

	Length	Depth	Height
Cabin Table	1800	1800	750

All Dimension in mm

MANAGER DESK SERIES



Dual Tone Table



This meticulously designed table emphasizes both functionality and aesthetics, featuring quality construction, stability measures, and a tasteful finish.

Quality Construction:

- 25mm thick pre-laminated Particle Board used for the top and Gable End.
- Edge banding all around ensures a polished finish.
- Incorporates a reinforcement tube beneath the top to prevent sagging.

Structural Elements:

- Features knock-down construction for streamlined assembly.
- 18mm thick pre-laminated Particle Board for the modesty panel.
- Gable foot brackets crafted from steel with nylon levelers.

Aesthetic Enhancements:

- Includes decorative profiles and design elements for a sophisticated appearance.

Cable Management:

- Equipped with an 8-module cable tray and access flap for seamless wire management.

Standard Finishes:

- Available in Classic Walnut & Highland Pine.

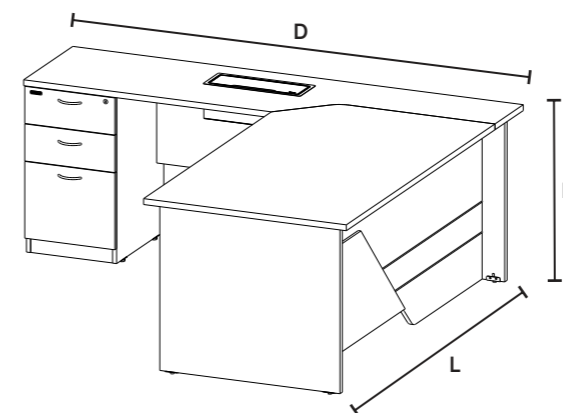

Dimensions

	Length	Depth	Height
Table	1650	1950	750
	2100	2250	750

All Dimension in mm

Prime Return Table



Experience a fusion of structural integrity and functional design for unparalleled office sophistication.

Quality Construction:

- Utilizes 25mm thick pre-laminated Particle Board for the top and Gable End.
- Return Top is also crafted from 25mm thick pre-laminated Particle Board.
- Edge banding is applied all around for a refined appearance.
- Modesty panel crafted from 18mm thick pre-laminated Particle Board.
- Gable foot brackets constructed from steel with nylon levelers for stability.
- Features a reinforcement tube beneath the top to prevent sagging.

Efficient Assembly:

- Incorporates efficient knock-down construction for simplified assembly.

Functional Design:

- Top-supported pedestal provided in a Box/Box/File (BBF) configuration.

Standard Finishes:

- Available in Thansu Maple with Graphite Grey.

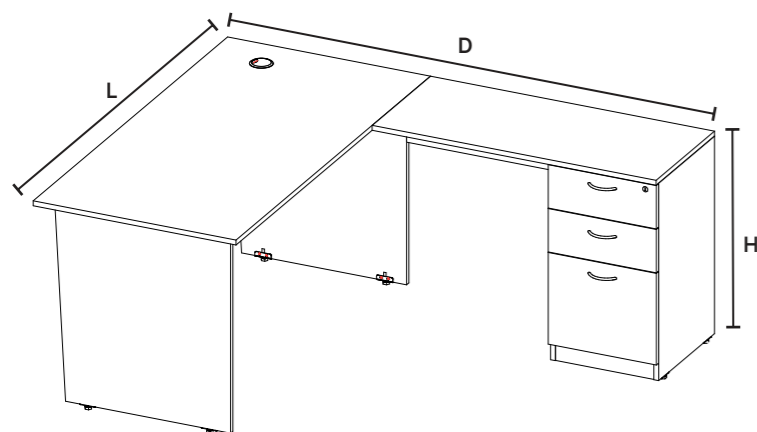
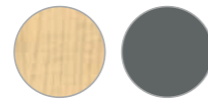

Dimensions

Length	Depth	Height
1500	1800	750

All Dimension in mm

Prime Curvilinear Table



Experience a fusion of functionality and elegance with this meticulously crafted furniture piece, available in a range of finishes to suit your preferences.

Efficient Assembly:

- Incorporates Knock-down Construction For Convenient And Swift Assembly.

Functional Design:

- Top-supported pedestal provided in Box/Box/File (BBF) configuration.
- Pedestal includes wooden drawers with bottom mounting slides for convenience.
- Equipped with a grommet to facilitate efficient wire management.

Quality Construction:

- Utilizes 25mm thick pre-laminated Particle Board for the top and Gable End.
- Features edge banding all around to ensure a polished finish.
- Modesty panel crafted from 18mm thick pre-laminated Particle Board.
- Gable foot brackets made of steel with nylon levelers for stability.
- Features a reinforcement tube beneath the top to prevent sagging.

Standard Finishes:

- Available in Highland Pine, Acacia, Frosty White, Thansu Maple, and Graphite Grey.



Dimensions

Length	Depth	Height
1500	1200	750

All Dimension in mm



Omni Table



Experience the versatility and sophistication of OMNI Tables, featuring streamlined assembly, sturdy construction, aesthetic design, and comprehensive wire management for a modern and organized workspace.

Quality Construction:

- CRCA leg construction ensures durability and stability for long-term use.
- Easily accessible switchboard integrated into the front modesty panel.
- PVC-edged banding on all sides of the pre-laminated particle board panel.

Cable Management:

- Cable management options from the floor, through the leg, and leg-to-leg, accommodating up to 6 cables with a 6mm diameter.

Structural Elements:

- Diverse perforation and color options enhance outer cover aesthetics.
- Inner covers facilitate cable maintenance, optimizing user workspace.
- Metal and Wooden modesty options with integrated cable way.
- Leg design allows various configurations, maximizing user space.

Modular Structure:

- Fully knockdown design for easy assembly and adaptability to different configurations.

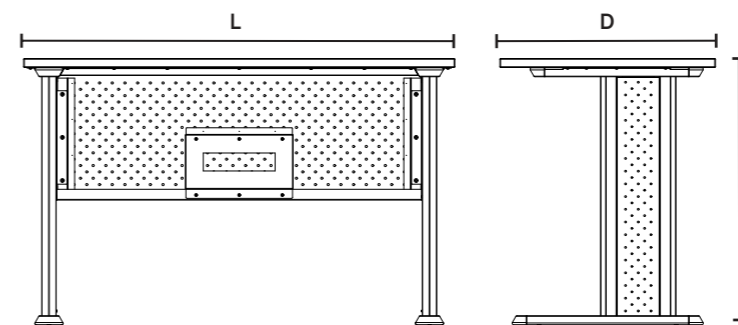

Dimensions

Length	Depth	Height
900	600/750	750
1200	600/750	750
1350	600/750	750
1500	600/750	750

All Dimension in mm

Maximus Office Table



- **Efficient Assembly:** Features knock-down assembly for efficiency.
- **Durable Materials:** 25mm thick Pre-Laminated Particle Board for top and Gable End.
- **Functional Design:** Modesty crafted from 18mm thick Particle Board.
- **Enhanced Stability:** Gable foot brackets made of steel with nylon levelers.
- **Organized Storage:** 3 drawers with central locking mechanism.
- **Structural Integrity:** Reinforcement tube prevents sagging.
- **Standard Finishes:** Available in Graphite Grey, Thansu Maple, Walnut, Wenge.

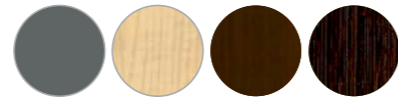

Dimensions

Length	Depth	Height
1200	600	750
1500	600	750

All Dimension in mm

Prime Office Table

- **Efficient Assembly:** Utilizes knock-down construction for quick setup.
- **Durable Materials:** 18mm thick Pre-Laminated Particle Board for top and Modesty.
- **Aesthetic Touch:** Gable End adorned with decorative aluminum profile.
- **Enhanced Stability:** Gable foot brackets made of steel with nylon levelers.
- **Standard Finishes:** Available in Wenge.



Dimensions

Length	Depth	Height
900	600	750
1200	600	750
1500	750	750
1800	750	750
1800	900	750

All Dimension in mm

Dalton Office Table

- **Efficient Assembly:** Incorporates knock-down construction for convenience.
- **Durable Materials:** 18mm thick Pre-Laminated Particle Board for top.
- **Functional Design:** Gable and Modesty made of 15mm thick Particle Board.
- **Organized Storage:** Includes 1 drawer and shutter compartment with 1 open shelf.
- **Standard Finishes:** Available in Walnut and Frosty White options.



Dimensions

Length	Depth	Height
1200	600	750

All Dimension in mm

Leonardo Office Table

- **Efficient Assembly:** Features knock-down construction for easy setup.
- **Durable Materials:** 18mm thick Pre-Laminated Particle Board for top.
- **Functional Design:** Gable and Modesty made of 15mm thick Particle Board.
- **Organized Storage:** Includes 2 box drawers, and 1 file drawer.
- **Standard Finishes:** Available in Wenge and Highline Pine options.



Dimensions

Length	Depth	Height
1200	600	750

All Dimension in mm

Noah Office Table

● **Premium Construction:**

- The top is crafted from high-quality 25mm thick material.
- Robust 25 x 25 mm x 1.2 mm thick MS Tube understructure.
- Modesty panel made of 0.6mm thick CRCA Sheet for added durability.

● **Refined Aesthetics:**

- Pre-laminated particle board with matching edge band ensures a polished appearance.

● **Stability Enhancement:**

- Four nylon levelers ensure proper and stable leveling.

● **Assembly Convenience:**

- Incorporates knockdown construction for easy and efficient assembly.



Noah Office Table With Single Drawer



Noah Office Table With One-Side Integrated Pedestal (BBF)



Noah Office Table With Both-Side Integrated Pedestal (BF+BBB)

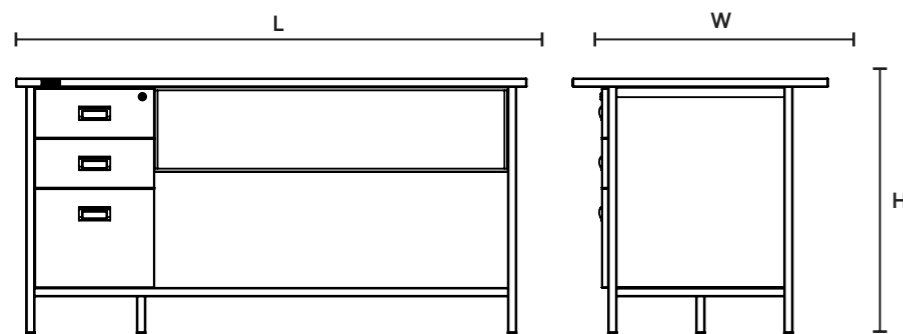

Dimensions

Length	Depth	Height
900	600	750
1200	600	750
1500	750	750
1800	900	750

All Dimension in mm

Stylo Table

● **Premium Construction:**

- The top is crafted from high-quality 25mm thick material.
- Robust 25 mm (Dia) x 1.2 mm thick MS Tube understructure.
- Modesty panel made of 0.6mm thick CRCA Sheet for added durability.

● **Refined Aesthetics:**

- Pre-laminated particle board with matching edge band ensures a polished appearance.

● **Stability Enhancement:**

- Four nylon levelers ensure proper and stable leveling.

● **Assembly Convenience:**

- Incorporates knockdown construction for easy and efficient assembly.



Stylo Office Table Without Drawer



Stylo Office Table With One-Side Integrated Pedestal (BBB)



Stylo Office Table With Both-Side Integrated Pedestal (BF+BBB)

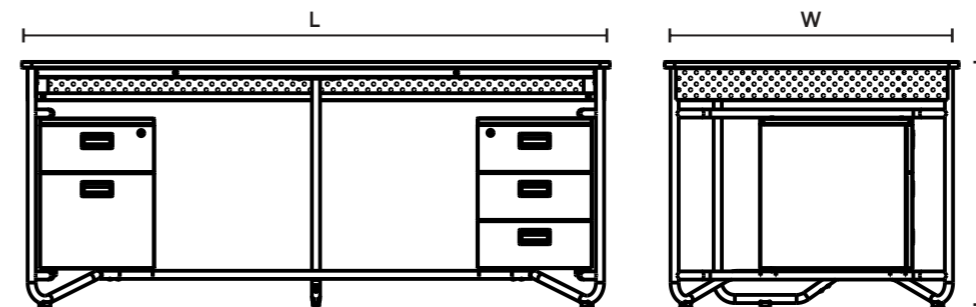

Dimensions

Length	Depth	Height
900	600	750
1200	600	750
1500	750	750
1800	900	750

All Dimension in mm

CONFERENCE TABLE



Assert Conference Table & Volga Mid-Back Chair

BOD Conference Table



Experience unmatched sophistication with a conference table that seamlessly blends streamlined assembly, premium materials, and robust structural design for an elevated workspace environment.

Quality Construction:

- 25mm thick pre-laminated particle board for the Top & Gable End with edge banding.
- Modesty crafted from 18mm thick pre-laminated particle board.

Structural Elements:

- Reinforcement below the top prevents sagging, ensuring long-lasting stability.
- Gable foot bracket constructed with steel, featuring nylon levelers.

Streamlined Assembly:

- Adopts efficient knock-down construction for simplified setup.

Standard Finishes:

- Available in Classic Walnut & Graphite Grey.

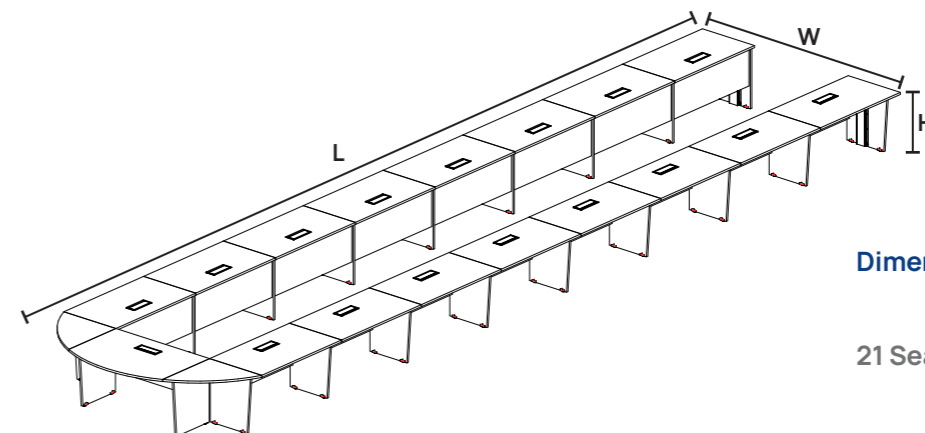

Dimensions

	Length	Depth	Height
21 Seater	6000	2700	750

All Dimension in mm

CONFERENCE TABLE

Conclave Conference Table



Discover the epitome of sophistication with CONCLAVE Conference Tables, featuring efficient assembly, premium materials, and advanced wire management for a truly refined workspace experience.

Quality Construction:

- 25mm thick pre-laminated Particle Board for the Top and Gable End.
- Edge banding applied all around for a polished finish.
- Modesty panel crafted from 18mm thick pre-laminated Particle Board.

Structural Elements:

- Gable foot brackets constructed from steel with nylon levelers for stability.

Streamlined Assembly:

- Utilizes knock-down construction for streamlined and convenient setup.

Wire Management:

- Equipped with an 8-module cable tray and access flap for seamless wire organization.

Standard Finishes:

- Available in Thansu Maple & Graphite Grey.



Dimensions

	Length	Depth	Height
8 Seater	2400	1100	750
10 Seater	3000	1100	750
12 Seater	3600	1100	750
14 Seater	4200	1100	750
16 Seater	4800	1100	750

All Dimension in mm

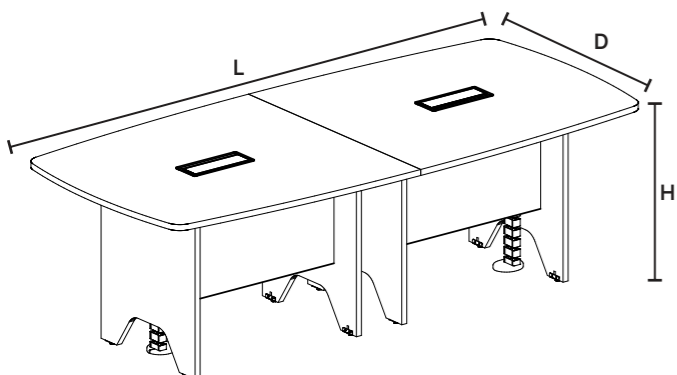

Neptune Conference Table



NEPTUNE Conference Tables embody efficiency, premium materials, and advanced wire management, ensuring a sophisticated and well-organized workspace environment through innovative design elements.

Quality Construction:

- Utilizes 25mm thick pre-laminated Particle Board for the Top and Gable End.
- Edge banding applied all around ensures a polished and durable finish.
- Modesty panel crafted from 18mm thick pre-laminated Particle Board.

Structural Elements:

- Gable foot brackets constructed from steel with nylon levelers for stability.

Streamlined Assembly:

- Features knock-down construction for streamlined and hassle-free setup.

Wire Management:

- Equipped with an 8-module cable tray and Access Flap for seamless wire organization via Vertebrae.

Standard Finishes:

- Available in Thansu Maple & Graphite Grey.



Dimensions

	Length	Depth	Height
8 Seater	2400	1200	750
10 Seater	3000	1200	750
12 Seater	3600	1200	750
14 Seater	4200	1200	750
16 Seater	4800	1200	750

All Dimension in mm

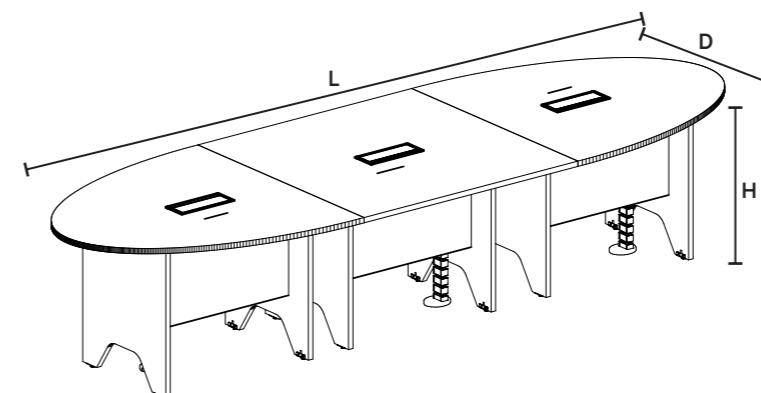

CONFERENCE TABLE

Forum Conference Table



FORUM Conference Tables offer a perfect blend of streamlined assembly, premium construction, structural integrity, and advanced wire management, ensuring a sophisticated and organized workspace.

Quality Construction:

- Utilizes 25mm thick pre-laminated Particle Board for the top and Gable End.
- Edge banding applied all around ensures a polished and durable finish.
- Modesty panel crafted from 18mm thick pre-laminated Particle Board.

Structural Elements:

- Gable foot brackets constructed from steel with nylon levelers for stability.

Streamlined Assembly:

- Features knock-down construction for effortless and efficient setup.

Wire Management:

- Equipped with an 8-module cable tray and Access Flap, facilitating seamless wire organization.

Standard Finishes:

- Available in Classic Walnut & Frosty White



Dimensions

	Length	Depth	Height
8 Seater	2400	1200	750
10 Seater	3000	1200	750
12 Seater	3600	1200	750
14 Seater	4200	1200	750
16 Seater	4800	1200	750

All Dimension in mm

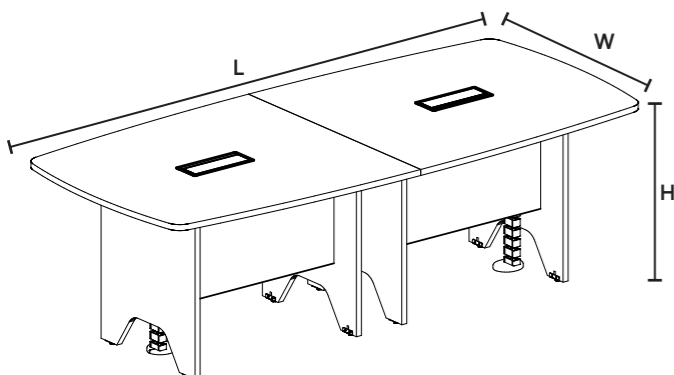

Parley Conference Table



PARLEY Conference Table embody a fusion of streamlined assembly, premium materials, structural integrity, & convenient wire management, ensuring sophisticated & well-organized workspace for productive discussions.

Quality Construction:

- Utilizes 25mm thick pre-laminated Particle Board for the top and Gable End.
- Edge banding applied all around ensures a polished and durable finish.
- Modesty panel crafted from 18mm thick pre-laminated Particle Board.

Structural Elements:

- Gable foot brackets constructed from steel with nylon levelers for stability.

Streamlined Assembly:

- Features knock-down construction for convenient and efficient setup.

Wire Management:

- Equipped with a grommet for seamless wire management.

Standard Finishes:

- Available in Classic Walnut & Graphite Grey.



Dimensions

	Length	Depth	Height
8 Seater	2400	1200	750
10 Seater	3000	1200	750
12 Seater	3600	1200	750
14 Seater	4200	1500	750
16 Seater	4800	1500	750

All Dimension in mm

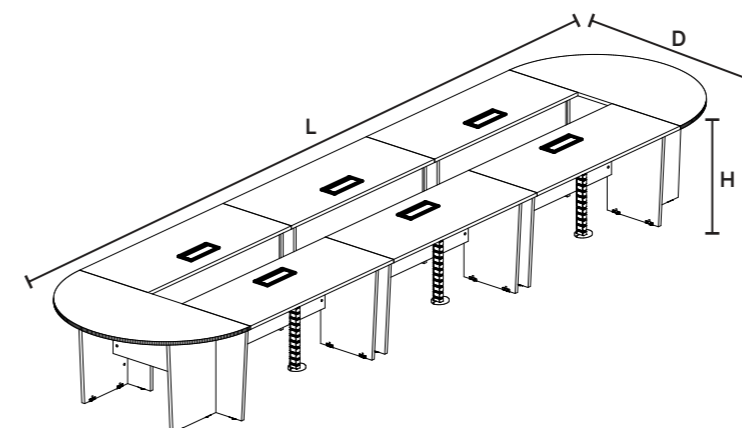

SEATING
SOLUTIONS





Command Series Chair

Thoughtfully Crafted Comfort: Foam back and seat designed for ergonomic support.

Intelligent Adjustments: Synchro with a 4-position locking mechanism for personalized comfort.

Luxurious Seating: Available in genuine leather or leatherette upholstery options.

Elegant Stability: Chrome Plated Aluminum Star Base.

Sculpted Armrests:

- High Back & Mid Back with 3D armrest with PU Top.
- Visitor Chair with Fixed Looped Armrest



High-Back
Chair



Mid-Back
Chair



Visitor
Chair

Available Colors

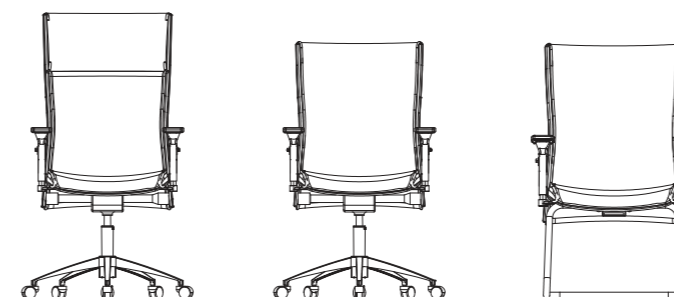

Dimensions

	Length	Depth	Height
High Back	700	690	1160/1260
Mid Back	700	690	960/1060
Visitor	650	620	1050

All Dimension in mm

EXECUTIVE OFFICE CHAIRS



Volga Plus Series Chair

Luxurious Seating: Leatherette Backrest and Seat Cushion with molded PU Foam and Hot-pressed Plywood.

Adaptable Comfort: Synchro with a 4-position locking mechanism for personalized adjustment.

Enhanced Support: Lumbar Support for enhanced ergonomic design with adjustable neck-rest*Elevated Armrests: 3D armrest with PU Top for added comfort.

Sturdy Foundation: 650mm Dia Aluminum Star Base* ensures stability.



High-Back Chair



Mid-Back Chair



Visitor Chair

Available Colors

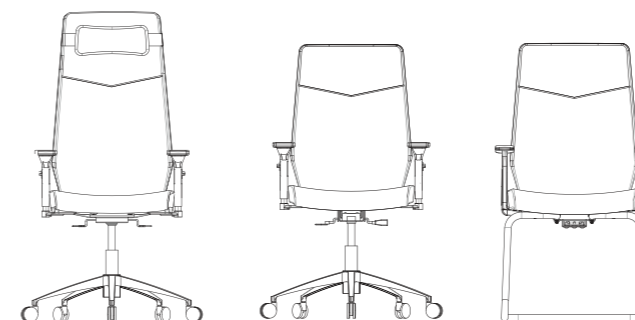

Dimensions

	Length	Depth	Height
High Back	700	715	1170/1270
Mid Back	700	715	1055/1155
Visitor	600	605	1070

All Dimension in mm



Boss Series Chair

Sumptuous Seating: Foam back and seat upholstered with premium leatherette fabric.

Dynamic Tilt: Center Tilt with upright locking Mechanism.

Elegance in Detail: Dual-tone handle with Wood and Aluminum for a sophisticated look.

Stylish Foundation: Chrome-plated Aluminum star base* / Cantilever Base*.



High-Back
Chair



Mid-Back
Chair



Visitor
Chair

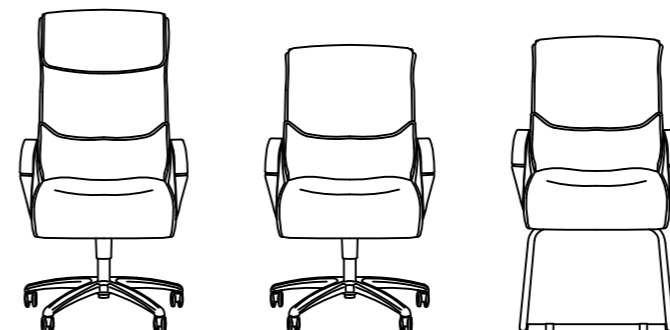

Available Colors



Dimensions	Length	Depth	Height
High Back	700	640	1150/1250
Mid Back	700	640	960/1060
Visitor	580	670	990

All Dimension in mm

Libra High Back



- PVC cushioned seat & back
- PP arms with soft PVC pads
- Center tilt mechanism
- Nylon star base
- Twin wheel nylon casters

Available Colors



Dimensions

	Length	Depth	Height
High Back	630	730	1100/1200

All Dimension in mm

Bold High Back



- PU Upholstery
- Centre Tilt Mechanism
- PU padded fixed polypropylene armrest
- Nylon Star Base
- Nylon Casters

Available Colors



Dimensions

	Length	Depth	Height
High Back	700	640	1020/1120

All Dimension in mm

Veneto High Back

- PU Upholstery
- Centre Tilt Mechanism
- PU padded fixed polypropylene armrest
- Nylon Star Base
- Twin Wheel Nylon Casters



Available Colors



Dimensions

	Length	Depth	Height
High Back	700	640	1050/1150

All Dimension in mm

Trenvi High Back

- PVC upholstery
- Center tilt mechanism
- PVC upholstered armrest
- Nylon star base & Nylon casters



Available Colors



Dimensions

	Length	Depth	Height
High Back	730	690	1120/1220

All Dimension in mm



Glory High Back

- Nylon frame backrest in mesh
- Seat upholstered with Leatherette fabric.
- Weight sensitive mechanism with multi position locking.
- PU padded headrest
- Adjustable lumbar support
- 3D Adjustable armrest with PU pad
- Nylon star base with twin wheel PU casters

Glory Mid Back

- Nylon frame backrest in mesh
- Seat upholstered with Leatherette fabric.
- Weight sensitive mechanism with multi position locking.
- Adjustable lumbar support
- 3D Adjustable armrest with PU pad
- Nylon star base with twin wheel PU casters



Glory Visitor Chair

- Nylon frame backrest in mesh
- Seat upholstered with Leatherette fabric.
- Adjustable lumbar support
- Fixed Armrest
- Powder Coated Under Structure

Dimensions

	Length	Depth	Height
High Back	700	730	1210/1330
Mid Back	700	730	1010/1130
Visitor	632	590	915

All Dimension in mm

Available in a Variety
of Colors Options:





Trenton High Back



- Mesh back chair with fabric upholstery on PU foam seat
- Adjustable Head rest and PU Arm rest
- Adjustable lumbar support
- Self adjustable mechanism with 4 locking position
- Nylon Star Base with Pu casters
- Nylon star base for extra load carrying capacity

Trenton Mid Back

- Mesh back chair with fabric upholstery on PU foam seat
- Adjustable PU arm rest
- Adjustable lumbar support
- Self adjustable mechanism with 4 locking position with nylon casters & star base
- Nylon star base for extra load carrying capacity



Available Colors



Dimensions

	Length	Depth	Height
High Back	710	700	1170/1270
Mid Back	710	700	970/1070

All Dimension in mm



Prius Mid Back



- Plastic Shell with Cushioned Back and Moulded Foam Seat Upholstered with Fabric
- Center Tilt with Upright Locking for All-Day Comfort
- Ergonomic Design for Enhanced Seating Experience
- Durable Construction for Long-Lasting Performance
- Versatile Style Suitable for Various Workspaces
- Easy Assembly and Maintenance for Convenience

Available in a Variety of Colors Options:



Dimensions

	Length	Depth	Height
Mid Back	710	710	865/955

All Dimension in mm



Zing Office Chair with Arm



- Height adjustable Revolving chair
- PU castors
- PP moulded Shell.
- Chrome plated Metal star base
- Seat cushion

Available Colors



Dimensions

	Length	Depth	Height
Mid Back	630	610	795/915

All Dimension in mm

Zing Office Chair without Arm



- Seat cushion made of Moulded PU Foam with Hot-pressed Plywood
- Crepe Fabric upholstery
- Standard Mechanism
- Nylon starbase & casters

Available Colors



Dimensions

	Length	Depth	Height
Mid Back	630	610	795/915

All Dimension in mm

Volga High Back

- Seat and Back made up of Ply with cushion upholstered with fabric
- PU padded Neckrest
- CTS mechanism
- Adjustable Armrest with PU Pad
- Dia 600mm Nylon Star base
- Nylon casters



Volga Mid Back

- Seat and Back made up of Ply with cushion upholstered with fabric
- CTS mechanism
- Adjustable Armrest with PU Pad
- Dia 600mm Nylon Star base
- Nylon casters



Volga Visitor Chair

- Foam back and seat upholstered with fabric.
- Powder Coated Under Structure
- Fixed Armrest



Dimensions

	Length	Depth	Height
High Back	730	700	1170/1270
Mid Back	730	700	1055/1155
Visitor	600	605	1070

All Dimension in mm

Available in a Variety of Colors Options:



Alba High Back

- Nylon Moulded Back Upholstered with Mesh
- Moulded Foam Seat Upholstered with Fabric
- Centre Tilt Synchro Mechanism with upright locking.
- Adjustable Headrest
- PP Height Adjustable Armrest
- Adjustable Lumbar Support
- MS chrome plated starbase



Alba Mid Back

- Nylon Moulded Back Upholstered with Mesh
- Moulded Foam Seat Upholstered with Fabric
- Centre Tilt Synchro Mechanism with upright locking.
- PP Height Adjustable Armrest
- Adjustable Lumbar Support
- Nylon Starbase



Dimensions

	Length	Depth	Height
High Back	660	660	1210/1310
Mid Back	660	660	1010/1110
Visitor	680	680	990

All Dimension in mm

Alba Visitor Chair

- Seat Made of Moulded Foam with Fabric
- Cantilever MS Powder Coated Base
- PP Armrest
- Push Back Mechanism
- Mesh with Nylon Back
- Adjustable Lumbar Support



Available in a Variety of Colors Options:



Victory Mid Back



- Center Tilt with Synchro Mechanism for All-Day Comfort
- Ergonomic Design for Enhanced Seating Experience
- 660 PCD Nylon Star Base for Enhanced Chair Stability
- Versatile Style Suitable for Various Workspaces
- Easy Assembly and Maintenance for Convenience

Available Colors



Dimensions

	Length	Depth	Height
Mid Back	660	710	970/1060

All Dimension in mm

Yaris Mid Back

- Mono Tilt with Spring Tension Mechanism for All-Day Comfort
- Ergonomic Design for Enhanced Seating Experience
- Sleek Chrome Star Base for Stylish Durability
- Versatile Style Suitable for Various Workspaces
- Easy Assembly and Maintenance for Convenience



Available Colors



Dimensions

	Length	Depth	Height
Mid Back	630	643	910/1030

All Dimension in mm

Thames Neo High Back

- Metal frame backrest with fabric
- Seat cushion made of Moulded PU Foam and Hot-pressed Plywood
- Push Back mechanism
- PP Fixed Armrest
- Dia 600mm Nylon Star base
- Nylon casters



Thames Neo Mid Back

- Metal frame backrest with fabric
- Seat cushion made of Moulded PU Foam and Hot-pressed Plywood
- Push Back mechanism
- PP Fixed Armrest
- Dia 600mm Nylon Star base
- Nylon casters

Thames Neo Visitor

- Foam back and seat upholstered with fabric.
- Powder Coated Under Structure
- Fixed Armrest.



Dimensions

	Length	Depth	Height
High Back	630	640	1045/1145
Mid Back	630	640	945/1045
Visitor	632	590	915

All Dimension in mm

Available Colors



Hexon High Back



- PP frame backrest in mesh.
- Seat cushion made of Moulded PU Foam and Hot-pressed Plywood
- CTS mechanism
- Adjustable Armrest with PU Pad
- Nylon Star base & Nylon casters

Hexon Mid Back

- PP frame backrest in mesh.
 - Seat cushion made of Moulded PU Foam and Hot-pressed Plywood
 - CTS mechanism
 - Adjustable Armrest with PU Pad
- Nylon Star base & casters



Available Colors



Dimensions

	Length	Depth	Height
High Back	665	695	1120/1220
Mid Back	665	695	975/1075

All Dimension in mm

Matrix High Back



- Seat with fabric upholstery
- Back with mesh and nylon back
- Adjustable lumbar support
- PP fixed armrests
- 100mm height gas lift (Class 3 BIFMA Certified)
- Centre tilt synchro mechanism with upright lock
- Nylon star base and casters

Matrix Mid Back

- Seat with fabric upholstery
- Back with mesh and nylon back
- Adjustable lumbar support
- PP fixed armrests
- 100mm height gas lift (Class 3 BIFMA Certified)
- Centre tilt synchro mechanism with upright lock
- Nylon star base and casters



Available Colors



Dimensions

	Length	Depth	Height
High Back	590	600	1155/1255
Mid Back	590	600	940/1040

All Dimension in mm

Savio High Back



- Nylon Starbase with Nylon casters
- Seat and Back made up of Ply with cushion upholstered with fabric
- Push back with upright locking
- Fixed PP armrest

Savio Mid Back

- Nylon Starbase with Nylon casters
- Seat and Back made up of Ply with cushion upholstered with fabric
- Push back with upright locking
- Fixed PP armrest



Available Colors



Dimensions	Length	Depth	Height
High Back	640	640	990/1090
Mid Back	640	640	920/1020

All Dimension in mm

Elite High Back

- Seat cushion made of Moulded PU Foam and Hot-Pressed Plywood
- Crepe fabric Upholtery
- Seat & back with edge PVC bedding
- Centre Tilt mechanism with upright locking
- Fixed Loop Armrest
- Metal star base with twin wheel casters



Elite Mid Back

- Seat cushion made of Moulded PU Foam and Hot-Pressed Plywood
- Crepe fabric Upholtery
- Seat & back with edge PVC bedding
- Centre Tilt mechanism with upright locking
- Fixed Loop Armrest
- Metal star base with twin wheel casters

Elite Visitor Chair

- Seat cushion made of Moulded PU Foam and Hot-Pressed Plywood
- Crepe fabric Upholtery
- Seat & back with edge PVC bedding
- Centre Tilt mechanism with upright locking
- Fixed Loop Armrest
- Powder coated MS base



Available Colors



Dimensions	Length	Depth	Height
High Back	710	710	1120/1220
Mid Back	710	710	830/930
Visitor	530	550	840

All Dimension in mm



Optima High Back

- Cushioned seat & back with fabric upholstery
- Centre Tilt Synchro Mechanism
- PP fixed armrests
- Nylon star base
- Nylon casters

Optima Mid Back

- Cushioned seat & back with fabric upholstery
- Centre Tilt Synchro Mechanism
- PP fixed armrests
- Nylon star base
- Nylon casters



Optima Visitor Chair

- Cushioned seat & back with fabric upholstery
- PP Fixed armrests
- Push Back Mechanism
- Powder coted MS Base



Dimensions

	Length	Depth	Height
High Back	680	680	980/1080
Mid Back	680	680	910/1010
Visitor	680	680	990

All Dimension in mm

Available Colors



Mustang Mid Back



- Mesh back chair with fabric upholstered seat
- Metal powder coated base & Twin wheel Nylon casters
- Push Back Mechanism

Available Colors



Dimensions

	Length	Depth	Height
High Back	700	700	850/970

All Dimension in mm

Xeon

- Ergonomically designed for maximum comfort
- Chrome plated starbase for extra load carrying capacity
- Centre tilt mechanism
- Mesh Back and molded foam seat with fabric upholstery
- Chrome Plated loop armrest

Available Colors



Dimensions

	Length	Depth	Height
High Back	580	610	980/1100

All Dimension in mm



Ethan Mid Back



- Mesh Back with cushioned seat in fabric upholstery for Seat and Back Cushion
- Center tilt synchro mechanism
- Adjustable Armrest
- 2 Way Adjustable Lumber support
- Nylon Star Base
- Nylon Casters

Available Colors



Dimensions

	Length	Depth	Height
High Back	600	600	940/1040

All Dimension in mm

Hanoi Mid Back

- Mesh Back Chair
- Centre Tilt Mechanism
- Fixed Armrest
- Nylon Star Base
- Nylon Casters



Available Colors



Dimensions

	Length	Depth	Height
High Back	600	600	920/1020

All Dimension in mm

Astor Mid Back



- Mesh Back
- Center Tilt Mechanism
- Fabric Upholstered Seat Cushion
- Fixed arm rest
- Nylon Star Base
- Nylon Casters

Available Colors



Dimensions

	Length	Depth	Height
High Back	600	600	920/1020

All Dimension in mm

Acqua High Back

- Mesh Back Chair
- Centre Tilt Mechanism
- Mesh Back and molded foam seat with fabric upholstery
- Chrome Plated loop armrest
- Chrome plated starbase
- Nylon Casters



Available Colors



Dimensions

	Length	Depth	Height
High Back	700	610	1070/1170

All Dimension in mm



**CONTRACT 01
SOFT PVC WITH ARMS**

- Frame made up of SS 202 with Mirror finish
 - Seat and Back made up of Ply and cushion upholstered with Soft PVC
 - Fabric upholstery also available in Maroon, Blue and Black
 - Stackable Design for space utilization
 - Chair with arm with PP top
- 590D X 530W X 787H



INTER LOCKING ARRANGEMENT



**CONTRACT 01
WITHOUT ARM**

- SS Tubular Frame
 - PVC upholstered Seat & Back.
 - Special Interlocking facility with Nylon footcap
 - Available in Crepe Fabric as well
 - Recommended for emergency evacuation
- 507W X 570D X 755H



**CONTRACT 02
WITH ARM**

- SS Tubular Frame
 - PVC upholstered Seat and Back
 - PP Armrest for extra support and comfort
 - Nylon footcap
- 550W X 605D X 788H



**CONTRACT 02
SOFT PVC WITHOUT ARMS**

- Frame made up of SS 202 with Mirror finish
 - Seat and Back made up of Ply and cushion upholstered with Soft PVC
 - Stackable Design for space utilization
- 605D X 486W X 765H



**CONTRACT 03
WITHOUT ARM**

- Loop Frame made-up of SS 202.
 - Seat and back made up of PP.
 - Nylon Foot caps
- 564D X 532W X 853H



**CONTRACT 05
WITHOUT ARM**

- SS Tubular Frame
 - PVC upholstered Seat and Back
 - easy stacking upto 10 levels
 - Comes with ganging and labelling facilities
 - Nylon foot cap
 - Side interlocking arrangement available on request
- 529W X 605D X 786H



**CONTRACT 11
SOFT PVC WITHOUT ARMS**

- Frame made up of SS 202 with Mirror finish
 - Seat and Back made up of Ply and cushion upholstered with Soft PVC
 - Stackable Design for space utilization
- 571D X 508W X 863H



**FESTA WITH
ARM-REST + CUSHION**

- Moulded PP seat and back
 - Powder coated tubular frame
 - Easily Removable Cushion
 - Stackable chair for space Constraints
 - Fixed armrest
- 533W X 560D X 828H



FESTA WITH ARM-REST

- Moulded PP seat and back
 - Powder coated tubular frame
 - Stackable chair for space Constraints
 - Fixed armrest
- 533W X 560D X 828H



FESTA WITHOUT ARM-REST

- Moulded PP seat and back
 - Powder coated frame made of MS ERW round pipe
- 533W X 560D X 828H



GUEST FOLDING CHAIR

- Moulded PP seat & back with powder coated
 - 19 mm dia MS Frame gives a durable, easy to carry Guest Chair
 - Sturdy - yet lightweight
 - This foldable chair can be stored below sofa, beds or resting against walls, behind doors
 - You can easily match it with different tables and styles
- 660L X 570W X 850H

Colour Options:





CHOPPER CHAIR

- PVC upholstered seat and back with PU foam for complete comfort
- Wooden arm rest
- Chrome plated Mild Steel Frame
580W X 620D X 810H



FALCON CHAIR

- Hard PVC upholstered seat and back with PU foam
- Cantilever Frame made up of Chrome plated Mild steel
- PU Cladding on Fixed Armrest
585W X 680D X 980H



INDUS CHAIR

- PU upholstered seat and back
- PU foam for complete comfort
- Chrome plated MS Frame
520W X 595D X 860H



AMAZE WITH ARM-REST

- Upholstered seat cushion on PP seat insert
- perforated backrest made of polypropylene
- fixed height arm rest with integral skin polyurethane arm pad
- Powder coated tubular frame
580W X 600D X 800H



RUNNER CHAIR

- Cantilever Frame made up of Chrome plated Mild steel
- PU Cladding on Fixed Armrest
- PU upholstered seat and back with PU foam
- PU Armrest
- Plastic Foot Cap Provided at the Bottom Which is in Contact Against the Floor
570W X 635D X 980H



ZING VISITOR CHAIR

- Seat cushion made of Moulded PU Foam with Hot-pressed Plywood
- Crepe Fabric upholstery
- Standard Mechanism
- Fabric cushion on seat and Back
530W X 550D X 890H



XEON CHAIR

- Seat cushion made of Moulded PU Foam and Hot-pressed Plywood
- Metal frame Back-Rest with Mesh fabric
- PP Fixed Armrest
- PC Metal Under structure
583W X 589D X 886H



STACKING TROLLY 01 & 02

- Frame is made up of 19 Dia pipe, 1 thk. MS ERW tubes with powder coted tubular frame
- Each trolley contain a no. plate for model no. MS CRCA sheet.
- Big wheels for easy maneuver.
- Stacking Capacity - Contract 01-20 chairs, Contract 02 - 12 chairs
571W X 774D X 584H



Thame with Full Tablet



- Fabric / Mesh Upholstered Back
- Upholstered Seat
- MS Powder Coated Legs
- Post-Laminated Ply Board with Edge-band for writing pad

Available Colors



Dimensions

	Length	Depth	Height
Chair	600	580	940
Tablet	611	310	18

All Dimension in mm

Zing with Writing Pad

- Seat-back Shell made of Polypropylene Cushion made of ply upholstered with neutral B fabric
- Post-Laminated Ply Board Writing Pad
- Prelaminated writing pad with PVC edge band with Nylon Foot-cap

Available Colors



Dimensions

	Length	Depth	Height
Chair	650	580	870
Tablet	350	405	18

All Dimension in mm



Amaze with Full Tablet



- Fabric / Mesh Upholstered Back
- Upholstered Seat
- MS Powder Coated Legs
- Post-Laminated Ply Board with Edge-band for writing pad

Available Colors



Dimensions

	Length	Depth	Height
Chair	580	600	800
Tablet	610	310	18

All Dimension in mm

Amaze with Castor & Full Tablet

- Modern and sturdy design
- PP seat with upholstered cushion
- Perforated backrest made of PP
- Powder coated MS Oblong tube with casters
- Armrest with PU Pad
- Post-Laminated Ply Board with PVC edge-band.



Available Colors



Dimensions

	Length	Depth	Height
Chair	580	600	800
Tablet	611	310	18

All Dimension in mm

Contract 01 with Full Tablet



- SS tubular frame and Legs Made of 1mm Thick Tube with Diameter of 16mm Stainless Steel
- PVC Upholstered Seat and Back on 12mm Plywood Covered with PU Foam
- Pre-Laminated Ply Board with PVC Edge-band for Writing Pad
- Post-Laminated Ply Board

Available Colors



Dimensions

	Length	Depth	Height
Chair	550	590	786
Tablet	611	310	18

All Dimension in mm

Contract 02 with Tablet

- SS tubular frame and Legs Made of 1mm Thick Tube with Diameter of 16mm Stainless Steel
- PVC Upholstered Seat and Back on 12mm Plywood Covered with PU Foam
- Pre-Laminated Ply Board with PVC Edge-band for Writing Pad
- Post-Laminated Ply Board



Available Colors



Dimensions

	Length	Depth	Height
Chair	550	605	788
Tablet	440	260	18

All Dimension in mm



STADIUM CHAIR

- Seat-back Shell made of moulded PP
- 2 Leg frame stand with powder coating
- Center- Center distance between seat - 460
- Grouted frame on the floor 1805W X 470D X 818.5H



ELANO 2 & 3 SEATER

- Combination of Powder Coated and Chrome Plated Mild Steel
- 2 Seater : 1220L X 680D X 780H
- 3 Seater : 1800L X 680D X 780H

NOVELLA 07 MULTI SEATER

- Shell back and seat made of moulded PP
 - Available with/without arms
 - 4 Leg frame with powder coated
 - Centre - centre distance between seat - 550
- 1682W X 638D X 856H



ITALIA 2 & 3 SEATER

- Combination of Powder Coated and Chrome Plated Mild Steel
- 2 Seater : 1180L X 660D X 770H
- 3 Seater : 1740L X 660D X 770H



SWING STADIUM SEATING

- Seat-back Shell made of moulded PP
- Sturdy Die Cast Aluminum Frame
- Center- Center distance between seat – 460 mm
- Grouted frame on the floor

CHR 12 STADIUM SEATING

- Seat-back Shell made of moulded PP
- Sturdy Die Cast Aluminum Frame
- Center- Center distance between seat – 460 mm
- Grouted frame on the floor





Glorious

- Synchronized Pushback Mechanism For Seat Slide And Back Recline.
- Auto Tip-up Seat
- PPCP Moulded Housing For Seat Cushion And Backrest
- Cushion Housing With Acoustical Perforation
- Concealed Slider Box Type Stand Design
- PPCP Armrest



Maximus - With & Without Writing Pad

- Synchronized Pushback Mechanism For Seat Slide And Back Recline.
- Auto Tip-up Seat
- PPCP Moulded Housing For Seat Cushion And Backrest
- Cushion Housing With Acoustical Perforation
- Concealed Slider Box Type Stand Design
- PU Armrest
- Foldable Writing Pad (Available with Maximus+)



Opera - With & Without Writing Pad

- Fixed Backrest
- Auto Tip-up Seat
- PPCP Moulded Housing For Seat Cushion And Backrest
- Foldable Writing Pad (Available with Opera+)
- Cushion Housing With Acoustical Perforation
- PU Armrest



Available Colors





Vault Storage

- Manufactured by prime quality CRCA
- Knock Down Structure
- Integrated Handle for easy access and
- Clean look
- Powder Coated panels for better
- Durability
- Adjustable Shelves
- Adjustable Leveler for alignment



Dimensions

	Length	Depth	Height
Vault 2015	900	450	2015
Vault 1315	900	450	1315
Vault 750	900	450	750

All Dimension in mm



VAULT PLU

- Complete knockdown structure & fully modular
- Available as main and add-on unit for space utilization
- Number of possible storage combination 1,2,4,6
- Ventilating holes for air circulation
- Powder coated finish, non-toxic zero-emission paints
- Available in cam lock
- Provision for name plate on each door
- Dual tone finish
- Primary material: crca (cold rolled close annealed)



COMBINATION WITH

Application Area



6d Cabin
45.2 Ltr Volume



4d Cabin
67.9 Ltr Volume



2d Cabin
136.4 Ltr Volume



1d Cabin
275.1 Ltr Volume

Dimensions

	Length	Depth	Height
Primary Tower	380	450	1830
Add On Tower	380	450	1830

All Dimension in mm



SCAN FOR VIDEO



LOCKR BOX

- Complete Knockdown structure and fully modular
- Number of possible Storage Locker combination 1,2,3 and 6
- Number of possible storage combination 1,2,4,6
- Made with 100% Virgin PP
- Comes with Pad Lock or Cam Lock or Num Lock
- Comes with slot available at the back for screwing/attaching to the wall
- Shelves inside can take a maximum Distributed Weight of 5 Kg

Application Area



6d Cabin
55.5 Ltr Volume



2d Cabin
156 Ltr Volume



3d Cabin
106 Ltr Volume



1d Cabin
308 Ltr Volume



COMBINATION WITH

Available Colors



Dimensions

	Length	Depth	Height
Primary Tower	380	475	1830
Add On Tower	380	475	1830

All Dimension in mm



SCAN FOR VIDEO

Rafel Storage (Metal Door)

- Complete knockdown structure
- Available in 3 way locking door
- Adjustable shelves to conceal and secure
- Fully enclosed bottom to help prevent moisture and dust
- Available in Metal Plane Door
- Number of Shelves 4 nos
- Primary Material CRCA (Cold rolled close Annealed)



Dimensions

	Length	Depth	Height
Rafel 2015	900	450	2015
Rafel 1200	900	450	1200
Rafel 750	900	450	750

All Dimension in mm

Rafel Storage (Wooden Door)

- Complete knockdown structure.
- Available locking doors
- Adjustable shelves to conceal and secure.
- Fully enclosed bottom to help prevent moisture and dust
- Available in Wooden Door
- Number of Shelves 4 nos
- Primary Material CRCA (Cold rolled close Annealed)



Rafel Storage (Glass Door)

- Complete knockdown structure.
- Adjustable shelves to conceal and secure
- Fully enclosed bottom to help prevent moisture and dust
- Glass can easily change without changing complete door assembly
- Number of Shelves 4 nos
- Primary Material CRCA (Cold rolled close Annealed)

Dimensions

Rafel	Length	Depth	Height
Wooden / Glass	900	450	2015

All Dimension in mm



Andy - Personal Locker Grey 18 PLU

- Complete knockdown structure.
- Available locking doors
- Adjustable shelves to conceal and secure.
- Fully enclosed bottom to help prevent moisture and dust
- Glass can easily change without changing complete door assembly.
- Available in Glass Door, Plane Door, Wooden Door
- Number of Shelves 4 nos.
- Primary Material CRCA (Cold rolled close Annealed)



Noble Office Almira

- Sturdy structure with complete knockdown design.
- Adjustable base with plinth screw to prevent skidding.
- Zinc alloy core lock with 90-degree rotations for security.
- Fully enclosed bottom prevents moisture and dust infiltration.
- Align lockers offer a secure storage solution.
- Integrated secret compartment for added belongings security.

Standard Finishes:

- Available in Body - Pearl White & Metal Door - Luster Brown, Oxford Blue, Natural Ebony.



Available Colors



Body



Metal Door



Dimensions

	Length	Depth	Height
Andy	900	400	1850
Grace	900	540	1950

All Dimension in mm

Squadro Glass Door Storewel

- Manufactured by prime quality of CRCA "cold rolled close annealed" Steel sheets
- Body and shelves made from a combination of 20-22 gauge steel sheets
- Four shelves provided making 4 equal compartments for storage
- High quality three way locking mechanism Also available with locker Almira and Glass door without locker



Squadro Office Almira

- Manufactured by prime quality of CRCA "cold rolled close annealed" Steel sheets
- Body and shelves made from a combination of 20-22 gauge steel sheets
- Four shelves provided making 4 equal compartments for storage
- High quality three way locking mechanism Also available with locker Almira and Glass door without locker

Dimensions

	Length	Depth	Height
Squadro Glass Door	900	540	2000
Squadro Office Almira	900	480	1900

All Dimension in mm



Squadro Storage with 2/3/4 Compartments

- Manufactured by prime quality CRCA
- Body and Drawers made from 22 guage
- Steel Sheets (0.8mm)
- Assembled/welded Structure
- Adjustable Leveler for alignment



Glaze Book Case

- Complete Welded Construction
- Available locking doors
- Fixed shelves to conceal and secure
- Fully enclosed bottom to help prevent moisture and dust
- Glass can easily change without changing complete door
- 3/4 Number of Shelves
- Primary Material CRCA (Cold rolled close Annealed)



Walter Book Case

- Complete knockdown structure.
- Door features a roller slider mechanism for smooth operation. Adjustable base with plinth screw for stability.
- Lock with zinc alloy core, 90-degree rotations for security.
- Fully enclosed body prevents dust and insects intrusion.
- Transparent toughened glass allows external visibility.
- Dual handles ensure a smooth door-opening experience.

Dimensions

	Length	Depth	Height
4 Compartment Storage	470	620	1320
3 Compartment Storage	470	620	1015
2 Compartment Storage	470	620	710

All Dimension in mm

Dimensions

	Length	Depth	Height
Glaze Book Case	840	330	1670
Walter Book Case	915	350	1750

All Dimension in mm

Squadro Mobile Locker Unit

- Manufactured by prime quality CRCA steel sheets
- Body and drawers made from 22 guage steel sheet (0.8mm)
- Knock down construction
- Locking facility with duplicate key
- Total 78 individual lockers



Squadro PLU

- Manufactured by prime quality CRCA steel sheets
- Body and drawers made from 22 guage steel sheet (0.8mm)
- Knock down construction
- Locking facility with duplicate key
- Available in 1/2/4/6 door

Dimensions

	Length	Depth	Height
Squadro Mobile Locker	1000	200	1800
Squadro PLU	380	457	1830

All Dimension in mm

Compactor

- Manufactured by prime quality CRCA steel sheets of 0.8 mm thickness
- Knock down construction
- Locking facility with duplicate key
- Undercarriage is manufactured of 3.1 mm HR sheet
- Bodies are bolted to rigid welded structure undercarriages and these move on channels
- Light duty - 50kg / shelf (uniformly distributed)
- Heavy duty - 80kg / shelf (uniformly distributed)

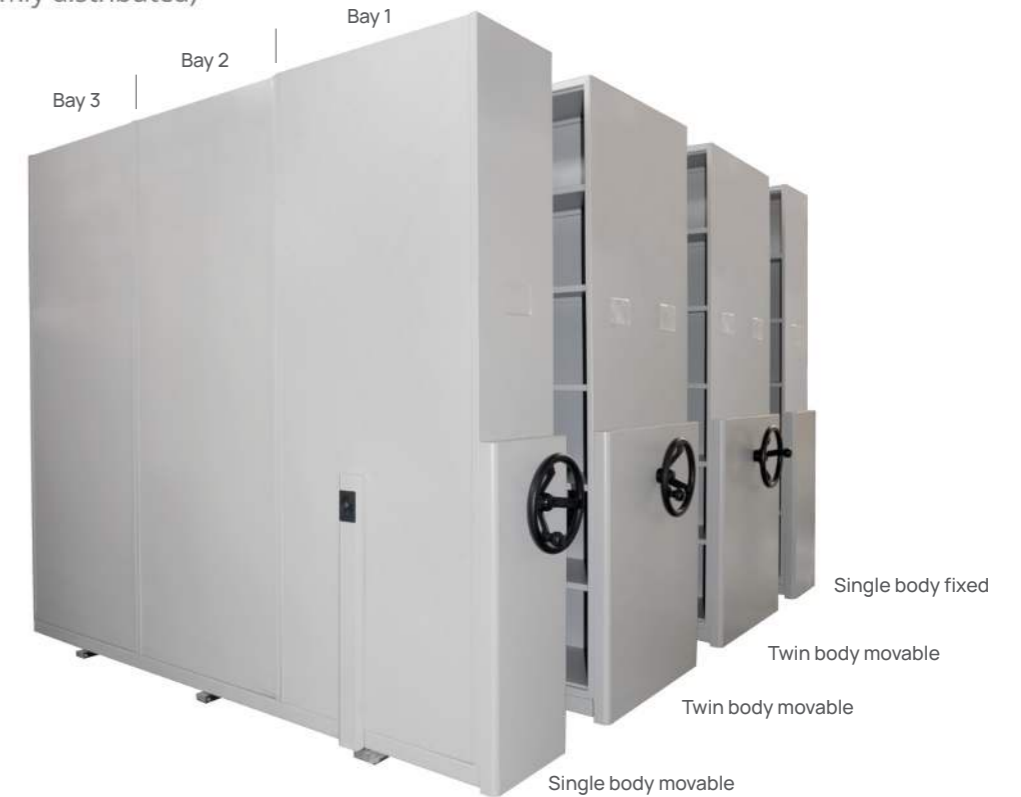

Dimensions

	Length	Depth	Height
Compactor	915	381/457	1980/2362

All Dimension in mm

STORAGE SOLUTIONS



Unibox Metal Facia
BBBB Graphite Grey



Unibox Metal Facia
BBBB White



Unibox Metal Facia
FF White



Unibox Wooden
Facia BBBB



Unibox Wooden
Facia BBF

Dimensions

Length	Depth	Height
400	450	650

All Dimension in mm

*All pedestals are available in variants: BBBB, BBF & FF



Unite - Wooden BBBB



Unite - Wooden BBF



Optimize - Wooden BBBB



Optimize - Wooden BBF

Dimensions

Length	Depth	Height
400	450	650

All Dimension in mm

*All pedestals are available in variants: BBBB, BBF & FF



Zing Chair - One Chair Many Possibilities

- Available with multiple versions e.g with cushion, w/o cushion, 4 leg frame, with armrest & without armrest, pedestal, writing pad etc
- Injection Moulded Shell made of Polypropylene
- Pipe size 16mm dia with 2 mm thickness
- Stackable
- Special joinery to assemble the shell with the frame assembly
- Stainless Steel or Ivory Powder Coated Leg Finish
- Nylon Foot-cap



Dimensions

	Length	Depth	Height
Zing Bar Stool	595	592	1200
Zing Chair	530	536	890

All Dimension in mm

Available Colors





NOVELLA 07

485W X 587D X 805H

Colours Available:



NOVELLA 08

475W X 530D X 813H

Colours Available:



NOVELLA 15

495W X 475D X 857H

Colours Available:



NOVELLA 17

446W X 530D X 905H

Colours Available:



NOVELLA 09

605W X 568D X 785H

Colours Available:



NOVELLA 10

595W X 580D X 760H

Colours Available:



NOVELLA 18

446W X 530D X 905H

Colours Available:



NOVELLA 19

446W X 530D X 905H

Colours Available:





CLUB

650W X 595D X 825H

Colours Available:



CLUB WITH CUSHION

650W X 595D X 825H

Colours Available:



CRYSTAL PC/PP

608W X 620D X 808H

PP Colours Available:



CAPTAIN CHAIR

650W X 575D X 805H

Colours Available:



ENAMORA

470W X 565D X 850H

Colours Available:



ENAMORA WITH CUSHION

470W X 565D X 850H

Colours Available:



ALL WOOD CHAIR

560W x 580D x 890H

Colours Available:



GOA SOFA

1 Seater: 740W X 715D X 820H
2 Seater: 1280W X 715D X 820H
3 Seater: 1820W X 715D X 820H

Cafeteria Table Top

Zayka - 35

isotop
World Class Technology



STABILITY



HEAT RESISTANT



DAMP PROOF



WEATHER RESISTANT



STAIN RESISTANT



MINIMUM MAINTENANCE



SCRATCH RESISTANT



RESISTANT TO CIGARETTE BURNS



Zayka Rectangle (White)



Zayka Square (Teak)



Zayka Round (Cherry wood)

Colours Available

Square & Rectangle



Round



Zayka

PREMIUM

ZAYKA PREMIUM range of table tops are made from sustainably harvested source and conform to BS-EN 438-2:2005 Standards. These tops now resist even more abrasion, rough handling, outdoor weather and last longer than the conventional moulded tabletops. Zayka Premium is UV resistant and available in Pearl White, Dark Walnut and Warm Grey colors only. The available sizes are 1200x800 and 800x800.



Zayka Rectangle (Yangon)



Zayka Square (Creiss)

laziz



Laziz Rectangle (Frosty White)

Laziz Rectangle (Silver Gray)



Laziz Square (Frosty White)

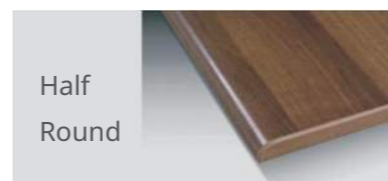

Half
Round



Full
Round

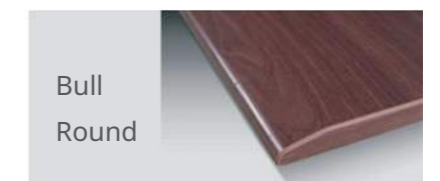

Bull
Round

Available In Customised Colours, Shapes & Sizes

Base



Base 01

1000/1800L X 650/900D X 750H



Base 03 (Aluminium)

1145L X 600D X 690H



Base 22

800L X 400D X 720H



Base 30

600L X 600D X 725H



Base 07 (Aluminium)

680L X 680D X 690H



Base 13

600L X 600D X 720H

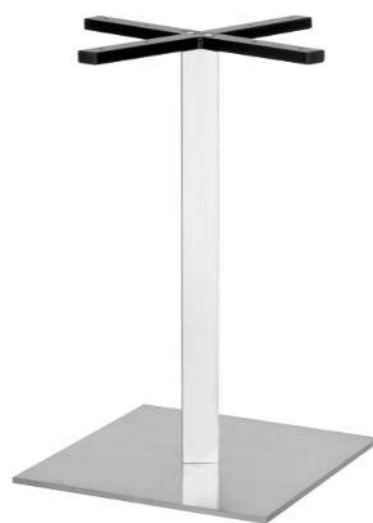

Base 21

450L X 450D X 720H



Base 32

700L X 700D X 720H



Base 34

1500L X 600D X 735H



Base 37

900L X 600D X 735H



Base 40

1100L X 600D X 725H



Base 48 A

1100L X 600D X 735H



Base 48 B

1700L X 600D X 735H



Base 44

800L X 800D X 1080H



Base 41

1700L X 600D X 725H



Base 42

600L X 600D X 735H



Base 48 C

600L X 600D X 735H



Base 51

1040L X 740D X 735H

Shapes	Round			Square			4 seater Rectangle		6 seater Rectangle	
Table top Dimension	600mm	900mm	1050mm	600mm	800mm	900mm	1200 x 800	1200 x 750	1800 x 800	1800 x 900
Matching Bases	7,42	21,13,42,48C	ABC	7,21,13,42	7,21,13,42,48C	21,13,30,42,48C	1,3,37,48A,51,22,40		1,48B,41,42,34	

Allure Lounge Chair

- Modern Design for Comfortable, Stylish Seating
- Enhanced Comfort with Additional Seat Cushion
- Plush Velvet Upholstery for Tactile Luxury
- Elegant Metal Legs with a Wooden Finish for Extra Stability

Available Colors



Lux Lounge Seating

- Feather-Light Yet Supportive Seating
- 40mm Foam with Luxury Fabric for Comfort
- Plush Velvet Upholstery for Tactile Luxury
- Wide Base for Extra Stability

Available Colors



Linea



Curve

Dimensions

	Length	Depth	Height
Allure Lounge Chair	570	620	786
Linea Lounge Seating	410	410	500
Curve Lounge Seating	435	435	500

All Dimension in mm

Coffee Table

Cube

615W X 6115D X 310H



Indiana

900 Dia X 750H



Britz

895W X 595D X 450H

BREAKOUT ZONE FURNITURE

Russo Sofa



- Upholstery of soft PVC
- Kiln dried solid hardwood & plywood frame
- Chrome plated legs
- 32 density medium soft foam for seat
- 28 density hard foam for backrest
- Available in 3/2/1 seater options

Standard Colors: Black & White



Dimensions

	Length	Depth	Height
1 Seater	940	720	685
2 Seater	1420	720	685
3 Seater	1910	720	685

All Dimension in mm

Brado



- Upholstery of soft PVC
- Kiln dried solid hardwood & plywood frame
- 32 density hard foam for seat & backrest
- Available in 3/2/1 seater options

Standard Colors: Black & White



Dimensions

	Length	Depth	Height
1 Seater	770	940	740
2 Seater	1220	940	740
3 Seater	1740	940	740

All Dimension in mm

Arrow



- Made up of soft PVC
- Chrome plated legs
- 32 density soft foam used for comfortable seats
- 28 density hard foam used for back rest
- Available in 3/2/1 seater options

Standard Colors: Black & White



Dimensions

	Length	Depth	Height
1 Seater	750	770	760
2 Seater	1220	770	760
3 Seater	1745	770	760

All Dimension in mm

Reed

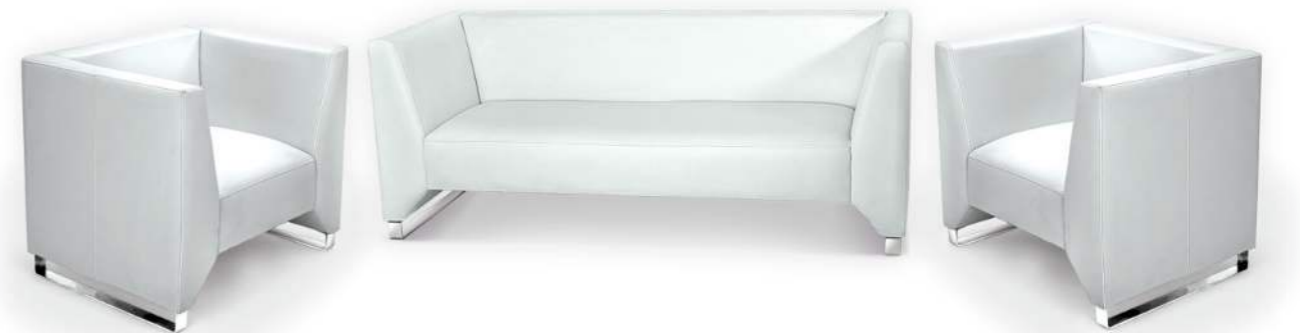

- Upholstery of soft PVC
- Kiln dried solid hardwood & plywood frame
- 32 density medium soft foam for seat
- 28 density hard foam for backrest
- Available in 3/2/1 seater options

Standard Colors: Black & White



Dimensions

	Length	Depth	Height
1 Seater	900	700	765
2 Seater	1385	700	765
3 Seater	1900	700	765

All Dimension in mm

Wello Water Wheel



Education Furniture



Sato Toilets



Waste Bins



SOCIAL IMPACT PRODUCTS



Magna Fincorp - Kolkata



Magna Fincorp - Thane



IIT - Mumbai



IIT - Mumbai



TATA Technologies



Amar Madhuban



Central Public Works Division



Central Public Works Division



Cronus Pharma



TCS



Central Public Works Division



Central Public Works Division

VALUED PARTNERS

