

AUDITORIUM SEATING





GLORIOUS

If You're Looking To Give Your Guests A Luxurious Experience, Our Glorious Auditorium Chairs Are Perfect. The Seat Is Comfortable And Features All The Amenities Your Guests Could Think Of, Including A Recliner Backrest, A Seat Tip-up System, And Even A Front Mount Cup Holder. You'll Definitely Dazzle Your Audience With These Chairs! With Its Clean Lines And Simple Design, This Seat Is The Ideal Choice For Style, Comfort, And Aesthetics.



KEY FEATURES

- Synchronized Pushback Mechanism For Seat Slide And Back Recline.
- Auto Tip-up Seat
- PPCP Moulded Housing For Seat Cushion And Backrest
- Cushion Housing With Acoustical Perforation
- Back And Seat Inner Frames By 2.2 Cm Dia Tubular Frame
- Engineered Seat And Back Cushions Made By High-pressure Technology With Best-in-class DOW Chemical From USA.
- Concealed Slider Box Type Stand Design
- PPCP Armrest
- Standard 3 Yrs Warranty Against Manufacturing Defects

LUXURIOUS SEAT PAN

This Chair Is Designed To Provide More Room And Comfort For The User, With A Seat That Is Larger Than Traditional Auditorium Chairs.

SUPER DESIGN AESTHETICS

This Chair Boasts A Sleek And Stylish Design That Is Sure To Catch Anyone's Eye.

IMPROVED ERGONOMICS

The Chair That Offers The Greatest Comfort Possible, And Their Adjustment To Body Posture Is An Added Value

EASY ON MAINTENANCE

The Chair Is Easy To Clean And Maintain, With Stain-Resistant And Easy-To-Clean Fabric.

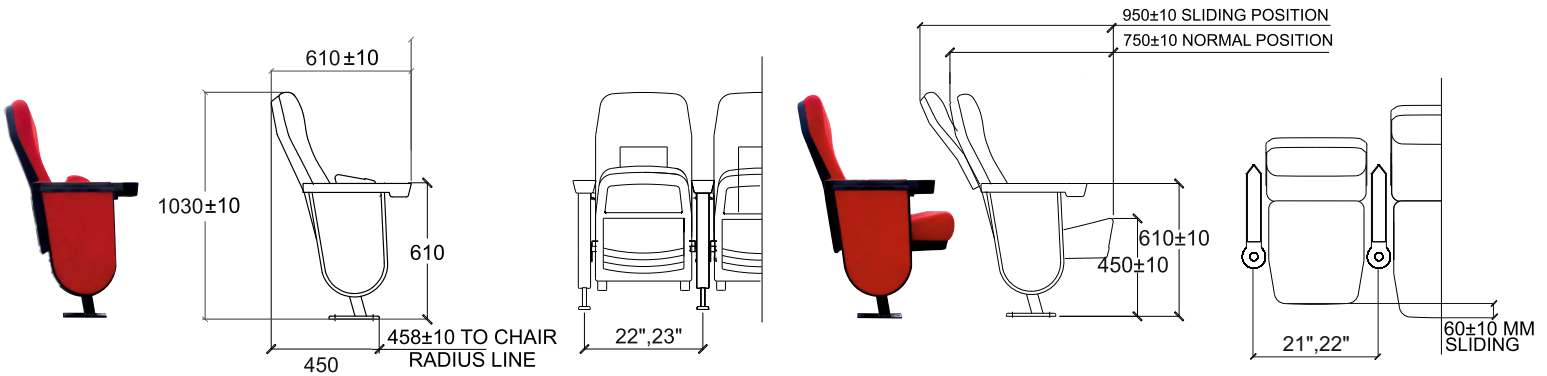



MAXIMUS +

Auditorium Seating Is Obviously One Of The Foundations Of A Good Venue. Maximus Plus Is A Contemporary And Sophisticated Auditorium Seat Suitable For High-end Facilities That Demand The Ultimate Comfort And Style Along With High Utilities. This State-of-the-art Auditorium Seat Features A Clean Design And An Upholstered Panel With A Heavy-duty Writing Pad. Maximus Plus Is An Ideal Seat For Corporate Auditoriums, Executive Training Centers, Or Even VIP Seating.



KEY FEATURES

- Synchronized Pushback Mechanism For Seat Slide And Back Recline.
- Auto Tip-up Seat
- PPCP Moulded Housing For Seat Cushion And Backrest
- Foldable Writing Pad Which Goes Inside The Side Panels To Conceal And Protect It When Not In Use.
- Cushion Housing With Acoustical Perforation
- Seat And Back Inner Frames By 2.2 Cm Dia Tubular Frame
- Engineered Seat And Back Cushions Made By High-Pressure Technology With Best-In-Class DOW Chemical From USA
- Concealed Slider Box Type Stand Design
- PU Armrest
- Standard 3 Yrs Warranty Against Manufacturing Defects

GENEROUS WORK SPACE

Integrated Writing Tablets Provide A More Spacious & Practical Workstation For Occupants To Take Notes And Use Laptops Or Other Portable Devices.

SUPERIOR DESIGN AESTHETICS

Designed To Comfortably Complement The Project Environment

SYNCHRONIZED PUSHBACK SYSTEM

Durable Synchronized Seat Forward Slide And Back Recline System

VERIFIED STRENGTH AND STABILITY

The Frames Are Welded Assemblies Of Heavy Gauge And Solid Steel Components

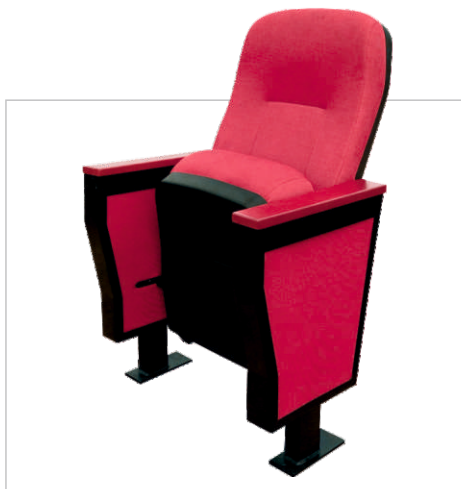
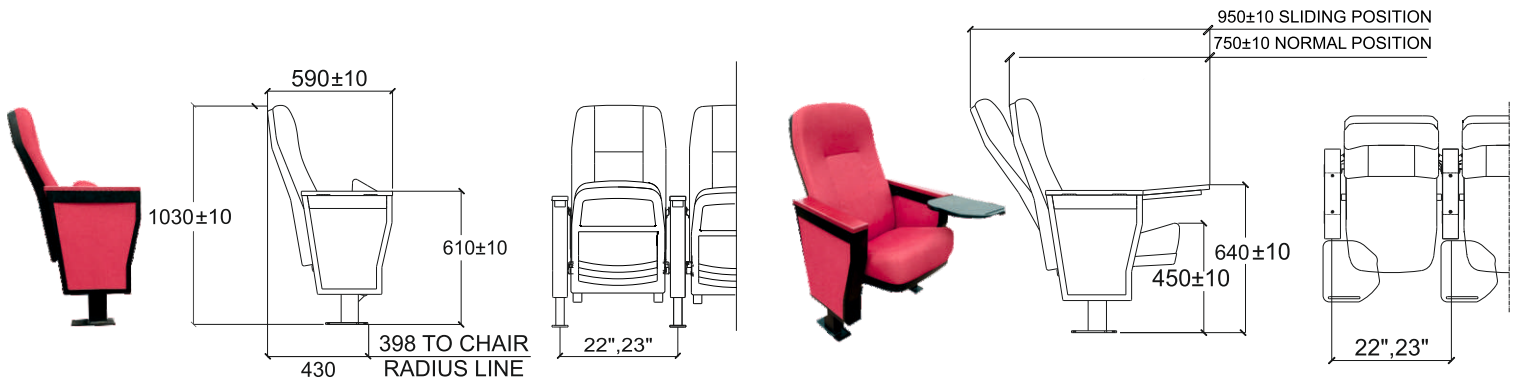



MAXIMUS

The Maximus Is The Theatre Seat Of Choice Where Comfort And Durability Are The Primary Concerns. In Venues Such As Auditoriums And Lecture Theatres, Occupants May Have To Remain Seated For Extended Periods Of Time. Its Unique Design With A Seat Tip-up System Allows Ease Of Access And Egress. The Recliner Backrest Options Ensure Maximum Comfort And Function. Designed To Be Comfortable And Maintenance-free Throughout Its Lifetime, This Seat Provides Levels Of Comfort Far Beyond Its Size.



KEY FEATURES

- Synchronized Pushback Mechanism For Seat Slide And Back Recline.
- Auto Tip-up Seat
- PPCP Moulded Housing For Seat Cushion And Backrest
- Cushion Housing With Acoustical Perforation
- Seat And Back Inner Frames By 2.2 Cm Dia Tubular Frame
- Engineered Seat And Back Cushions Made By High-Pressure Technology With Best-In-Class DOW Chemical From USA.
- PPCP Armrest
- Standard 3 Yrs Warranty Against Manufacturing Defects

IMPROVED COMFORT

Ergonomics Are A Fundamental Part Of The Design That Guarantees Maximum Comfort And Well-being For The User.

SYNCHRONIZED PUSHBACK SYSTEM

Durable Synchronized Seat Forward Slide And Back Recline System

EASY ACCESS

Small Closed Depth, It Can Be Incorporated Into Narrow Tiers Without Compromising On Comfort Or Access.

VERIFIED STRENGTH AND STABILITY

The Frames Are Welded Assemblies Of Heavy Gauge And Solid Steel Components

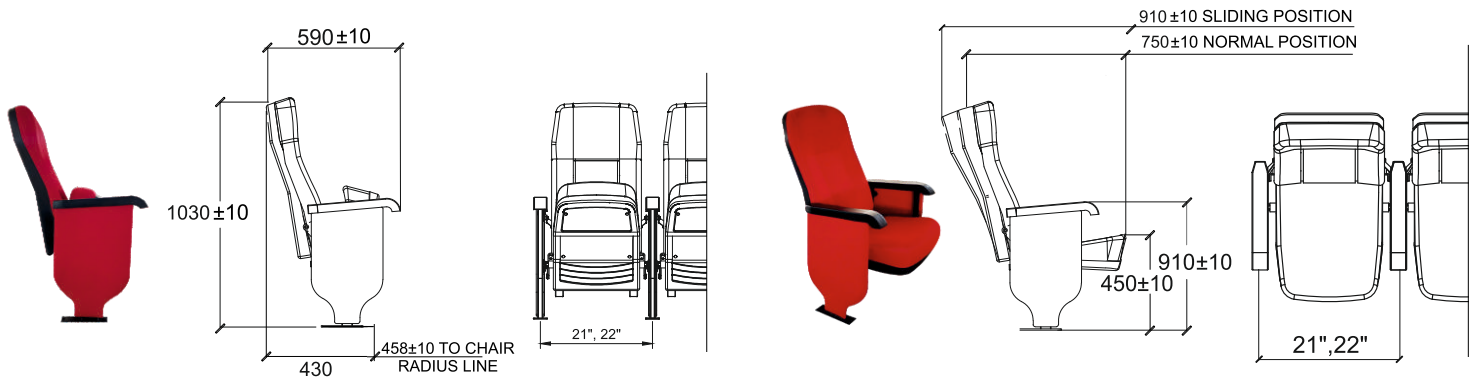

OPERA +

Lecture Sitting Can Be Found In Almost Every College And University. Given That A Child Spends As Much As 8 To 9 Hours Per Day Sitting At A Desk, The Opera Plus Auditorium Chair Is Uniquely Designed For The Utmost Comfort Of The Occupant. The Integrated Writing Pad Is An Additional Feature To The Lecture Seating, Which Is Arranged Keeping The Present And Advanced Educational Scenarios' Needs In Mind.

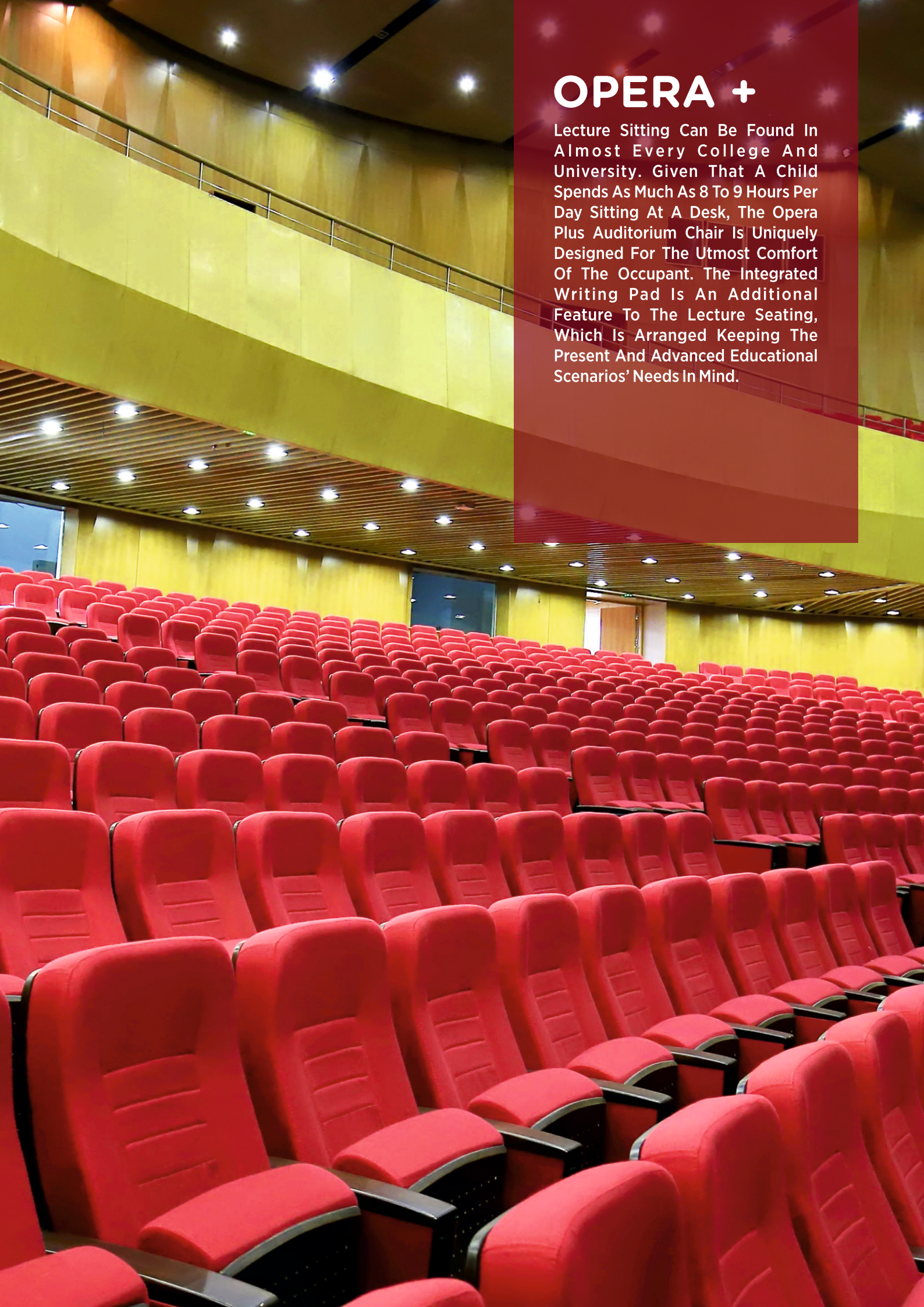



KEY FEATURES

- Fixed Backrest
- Auto Tip-up Seat
- PPCP Moulded Housing For Seat Cushion And Backrest
- Foldable Writing Pad Which Goes Inside The Side Panels To Conceal It And Protect When Not In Use.
- Cushion Housing With Acoustical Perforation
- Seat And Back Inner Frames By 2.2 Cm Dia Tubular Frame
- Engineered Seat And Back Cushions Made By High-Pressure Technology With Best-In-Class DOW Chemical From USA.
- PU Armrest
- Standard 3 Yrs Warranty Against Manufacturing Defects



TRADITIONAL LECTURE THEATRE SEATING

Made-To-Measure Lecture Theatre Seating With A Durable Tip-up Mechanism And Integrated Writing Pad.

TIP-UP MECHANISM

Seat Tip-up Action Is Attained By The Use Of A Tested And Proven Torsion Spring Mechanism; That Will Never Fail To Return The Seat To Its Upright Position.

ENDLESS DESIGN POTENTIAL

A Clean, Functional Design Makes This Auditorium Chair A Popular Choice Among Universities And Corporate Training Rooms.

COST OF OWNERSHIP

With Superior Service And Warranty Levels Offered By Nilkamal, Purchasing Opera Plus Seating Is A Better Long-term Value.

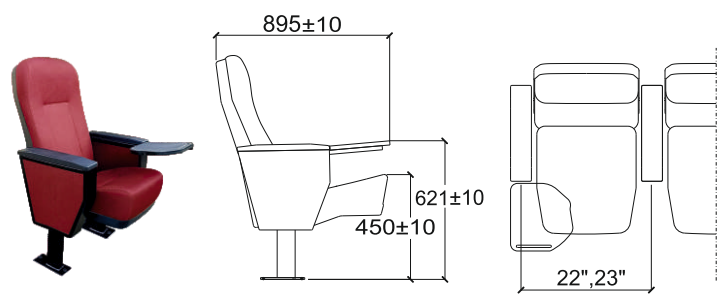
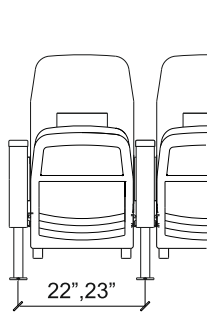
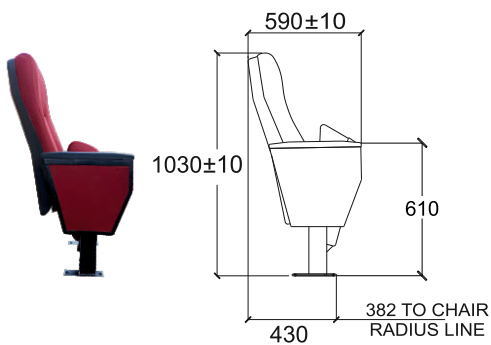



OPERA

The Opera Is An Auditorium Chair That Provides High Levels Of Comfort And Versatility Beyond Its Compact Size. Opera Is Designed As The Ideal Fixed Seating Solution For Modern Conference Projects, And Its Modular Design Makes It Easy To Install, Maintain, And Configure. It Is Perfect For Projects With A Limited Budget And Timeframe. Opera Chair Offers High-quality Seats At Reasonable Prices.



KEY FEATURES

- Fixed Backrest
- Auto Tip-up Seat
- PPCP Moulded Housing For Seat Cushion And Backrest
- Cushion Housing With Acoustical Perforation
- Seat And Back Inner Frames By 2.2 Cm Dia Tubular Frame
- Engineered Seat And Back Cushions Made By High-Pressure Technology With Best-In-Class DOW Chemical From USA.
- PPCP Armrest
- Standard 3 Yrs Warranty Against Manufacturing Defects

LONG LASTING

Robust And Durable, Fixed Seating Is Designed To Provide Many Years Of Maintenance-Free Usage.

IMPROVED COMFORT

High-quality Foam And Fabric Comfort Is An Important Specification When Designing Seating Plans In Venues Such As Auditoriums And Lecture Theatres.

EASY CLEANING

Opera Plus Can Be Cleaned Quickly And Efficiently. Seat's Tip-up System Provides Full Access Underneath.

UNIFORM AESTHETICS

Neat Rows With Orderly Seat Spacing Are Pleasing To The Eye. This Can Enhance And Transform Venues, Attracting Potential Clients, Visitors, Or Students.

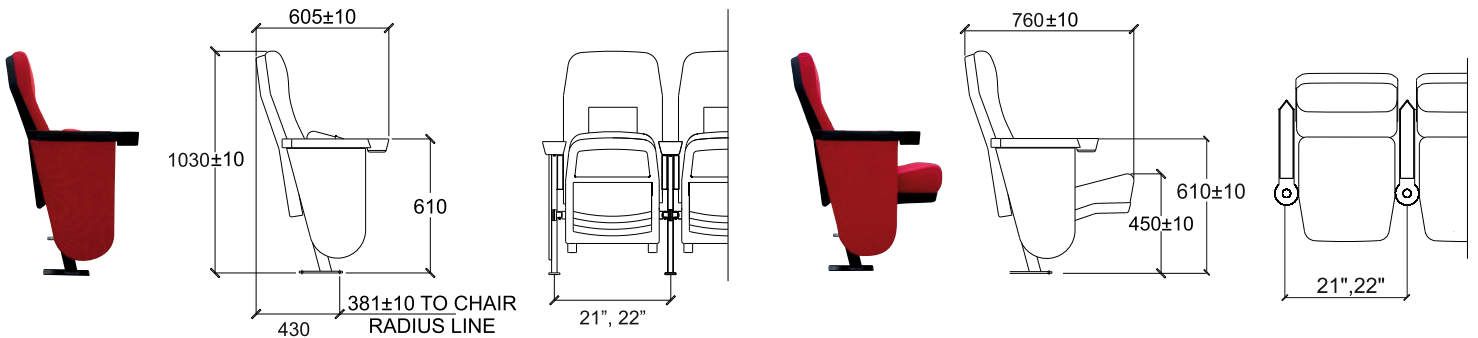



Nilkamal

India's Favourite Furniture

Nilkamal's Association With Furniture Needs No Introduction. Nilkamal Is The World's Largest Manufacturer Of Moulded Furniture & India's Favourite Furniture Brand With 50 Stores, 1,100+ Distributors, And 20000+ Dealers. From The Fast-paced Metro Cities To The Deepest Regions Of India, Nilkamal Aims To Bring Quality And Budget-friendly Furniture To Everyone. Our Furniture Has Eternally Been A Part Of Indian Homes' Interiors, Knowingly Or Unknowingly Taking Space In The Form Of A Simple Plastic Chair In Your Living Room Or An Entire Furniture Set In Your Bedrooms Or Offices Adding Both Emotion And Charm To Your Sheen Interiors.

With A Massive Manufacturing Setup And Vast Experience Managing Projects Of All Sizes, Nilkamal Is A Leading Manufacturer And Installer Of Retractable And Auditorium Seating. We Are Known Throughout The Industry For Our High-quality Products. We Put A Strong Emphasis On Ensuring That Our Products Conform To All Relevant Standards And That They Are Safely Maintained Throughout Their Lifetime.

