

# RUBY® 10 RUBY® 10 Speech



*Advanced Features and Functions*



© 2021 Freedom Scientific, Inc. All Rights Reserved. RUBY® is a registered trademark of Freedom Scientific, Inc. in the United States and other countries. Information in this document is subject to change without notice. No part of this publication may be reproduced or transmitted in any form or any means electronic or mechanical, for any purpose, without the express written permission of Freedom Scientific.

## Your Purchase

Depending on your needs, you have either received a RUBY 10 or RUBY 10 Speech. RUBY 10 Speech includes optical character recognition (OCR) and speech functionality—not RUBY 10. If you have RUBY 10, please disregard sections of this user's guide that describe the speech or scanning controls.

## Warranty

Congratulations on your purchase of the RUBY 10 or RUBY 10 Speech Video Magnifier. To register your product and validate your warranty, visit the [Freedom Scientific website](#).

**Caution:** These devices have no user-serviceable components. Any unauthorized attempt to service or replace internal components by opening the case will void the product warranty.

## Technical Support

You can search our [knowledgebase](#) for immediate answers to your product questions. Freedom Scientific also offers free technical support to its U.S. customers using any of the following methods:

- [Submit a Technical Support request](#)
- Call +1 (727) 803-8600 weekdays between 8:30 AM and 7:00 PM ET
- Send an email to [support@freedomscientific.com](mailto:support@freedomscientific.com)

International customers are supported by their local dealer or distributor. Use our [dealer locator](#) to find the dealer serving your area.

If you need to return your unit, the technical support specialist will issue a Return Materials Authorization (RMA) number that must be referenced on the outside of the package containing your returned unit. Your unit or its accessory will then be exchanged or repaired as needed.

## Table of Contents

Your Purchase .....	ii
Warranty .....	ii
Technical Support .....	ii
<b>Getting Started.....</b>	<b>1</b>
Charge RUBY 10 .....	1
First Use.....	2
Power Down and Standby.....	3
<b>RUBY 10 Overview.....</b>	<b>4</b>
How to Use This Guide .....	4
What's in the Box? .....	4
Snapshots and Captures.....	5
RUBY 10 versus RUBY 10 Speech.....	5
Help Text.....	5
Views .....	8
Physical Buttons.....	12
On-screen Buttons .....	14
Display Options .....	15
Touch Screen.....	15
Menus .....	16
Tactile Response .....	17
<b>Default Mode and Advanced Mode.....</b>	<b>18</b>
Default Mode.....	18
Default Mode Main Menu.....	19
Default Live View On-screen Buttons .....	20
Advanced Mode .....	24
Advanced Mode Main Menu .....	24
Advanced Mode Live View On-screen Buttons .....	25

<b>Cameras .....</b>	<b>32</b>
Magnification Camera .....	33
Overview Camera .....	34
Full-page Camera .....	37
Reading .....	39
Writing .....	40
Hobbies .....	40
<b>Live View .....</b>	<b>41</b>
Magnifying an Image in Live View .....	41
Color Modes .....	42
Tap to Focus and Show/Hide On-screen Buttons .....	42
Focus Lock .....	42
Light .....	42
Lines and Masks .....	42
Taking a Snapshot .....	43
<b>Color, Contrast, and Clarity .....</b>	<b>44</b>
Color Combinations .....	45
Text Color Combinations .....	45
Image Color Combinations .....	46
Adding Color Combinations .....	46
Visual Display Settings .....	48
Light Sensitivity Filter .....	48
Color Blindness Filter .....	48
Visual Properties .....	49
Brightness .....	50
Contrast .....	50
Edge Effects .....	51
Reset Settings .....	54

<b>Saving and Scanning Files.....</b>	<b>55</b>
Capturing a Page .....	55
Capturing Multiple Pages .....	55
Navigating Using the Touch Screen.....	57
Navigating Using Page Numbers.....	57
Changing the Page Order .....	58
Saving a File .....	58
Recording Audio Tags.....	59
Reading Language and Voice .....	60
Viewing Modes.....	61
Text Mode button.....	62
Viewing Modes Screen .....	62
<b>Managing Files.....</b>	<b>64</b>
Opening and Editing a File .....	64
Image Files .....	65
Document Files.....	65
File Names .....	66
Exporting or Importing Files.....	66
Storing Files .....	67
Deleting Files .....	68
<b>Connecting RUBY 10 to Other Devices .....</b>	<b>69</b>
Audio Jack Connections.....	69
USB-C Cable Connections .....	69
Miracast Wireless Connection .....	70
Connecting to a Miracast-enabled Display .....	70
Status of Miracast Connection .....	71

Bluetooth Wireless Connection .....	72
Using Bluetooth to Connect .....	72
Re-enable Bluetooth .....	73
Status of Bluetooth Connection.....	73
<b>Updating RUBY 10 .....</b>	<b>74</b>
Requirements .....	74
Update RUBY 10 Using a USB-C Drive .....	75
Update Using a USB Cable .....	76
<b>Menus .....</b>	<b>78</b>
File Manager .....	79
Settings Menu .....	79
Appearance Menu .....	80
Language Menu.....	81
System Settings.....	82
Default Mode / Advanced Mode .....	83
About.....	83
Miracast .....	83
Bluetooth.....	84
Visual Properties .....	84
Sound Settings.....	84

To get started, follow the instructions in this section for charging the device and using it for the first time.

### Charge RUBY 10

Fully charge RUBY 10 before using it for the first time. It takes about four hours to fully charge the device. Anytime the charging LED light on the left side of the device is red, the battery needs to be charged. You can work when the LED is solid red, which means that the battery is charging. However, it is best to leave it plugged in until the light turns green.



The light turns green when the battery is fully charged. With a fully charged battery, you can use the device for about three hours without it being plugged in. It is best to charge it whenever possible.

To charge RUBY 10:

1. Insert the USB Type C cable into the USB-C slot on the left side of the device.
2. Attach the power adapter to the USB-C cable, and plug the power adapter into an electrical outlet. You can alternately insert the cable into a computer without using the adapter, but this charging method is slower.
3. Power on RUBY 10 by pressing the orange Power button on the left side of the device.
4. See the next section, [First Use](#).

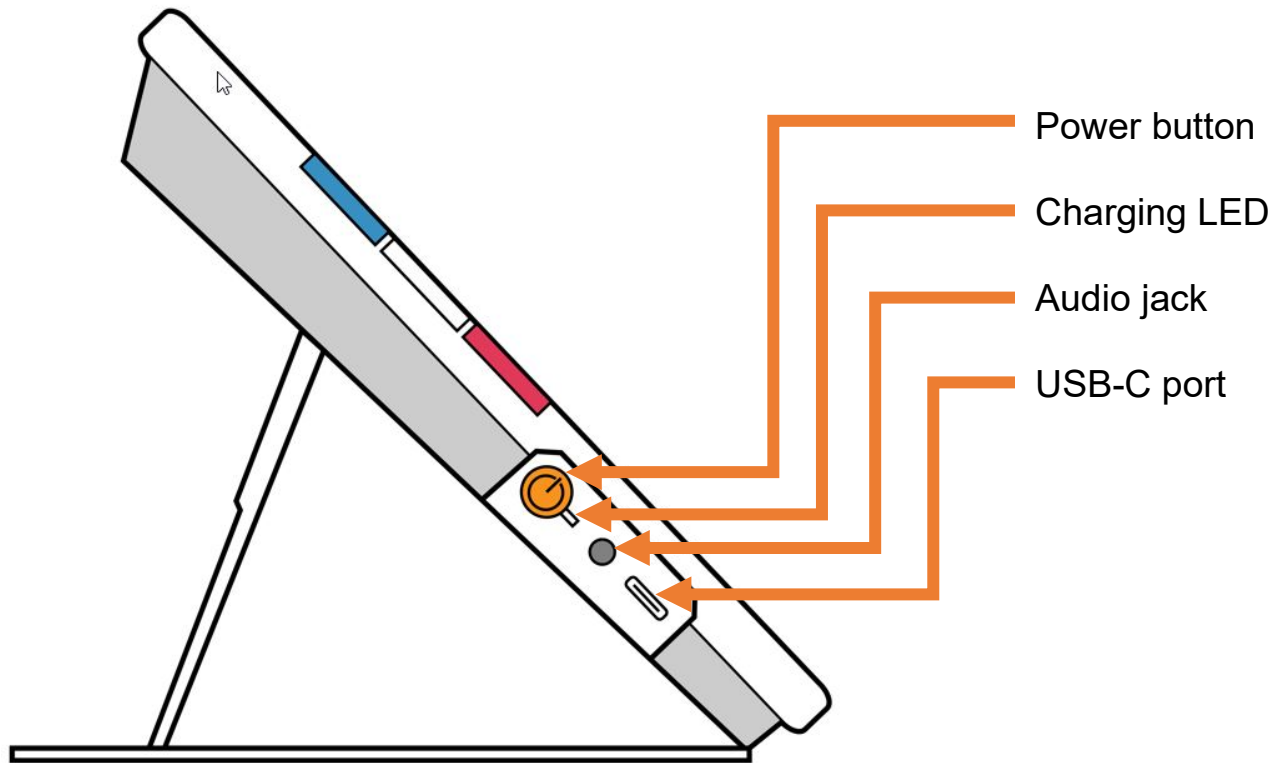

## First Use

The first time you use RUBY 10, you must select the menu language and voice, font size, and time and date. You cannot use the device until you set these options. However, you can change the settings later if needed using the instructions in this document. You only need to set these options again if you reset the device to factory settings.

**Tip:** If you are uncertain about a button or icon, you can display help text by pressing on the control for about three seconds until you see help text displayed on the screen.

Before you begin using RUBY 10:

1. Charge RUBY 10 and power on the device. See the [previous section](#).
2. The first time you power on your RUBY 10, the **Select Menu Language** screen is displayed. Swipe up or down until the language to be used for displaying the user interface (e.g., screens and help text) is selected in the center of the screen.



3. Tap the **Next** button in the lower right corner to go to the next screen.



4. On the **Font Size** screen, scroll to select the size of text you want used to display the user interface. Tap the **Next** button. If you want to return to the previous screen, tap the **Back** arrow in the lower left corner.



- 
5. **RUBY 10 Speech only:** On the **Select Menu Voice** screen, select the voice you want used to narrate the user interface, such as the menu names and the help text. Tap the **Next** button.

**Note:** You can easily change the voice later by going to **Main Menu > Settings Menu > Language Menu > Select Menu Language**.

- 
6. On the **Select Date** screen, scroll through each column to select the month, day, and year. Tap the **Next** button.
  7. On the **Select Time** screen, scroll through each column to select the hour, minutes, and AM or PM. You can also choose a 24-hour clock if desired. Tap the **Next** button. Setup is complete and Live view displays.

**Note:** If the time changes to daylight savings time or standard time, you can easily change the time by going to **Main Menu > Settings Menu > System Settings > Time & Date**.

## Power Down and Standby

To put the device on standby, briefly press the orange Power button. Press it for seven seconds to power down.

## How to Use This Guide

We recommend that you first familiarize yourself with the information in this overview so you can easily recognize the names of the buttons, icons, and menus. You may find it useful to print all or parts of this document, which is formatted for double-sided printing (odd pages on front and even pages on back).

The instructions are organized by task. Review the table of contents and perform searches within this file to find the information you need.

RUBY 10 has no speech or text recognition, while RUBY 10 Speech has both. If you have a RUBY 10, then descriptions of speech features and text recognition in this document do not apply to you.

## What's in the Box?

The RUBY 10 packaging contains:

- The RUBY 10 video magnifier or the RUBY 10 Speech video magnifier
- A protective pouch
- A USB power supply with USB-C cable
- 4 country-specific power plugs (EU, US, UK, and AU)
- A screen cleaning cloth
- *Safety and Care* document
- *Setup and Use* document

If any of these items are missing from your package, contact your distributor or Freedom Scientific.

## Snapshots and Captures

Live video and capture are available using three cameras, each with its own purpose. Live video allows you to get a magnified or augmented view of an object and prepare the camera to take a clear snapshot. Capturing allows you to save a snapshot, recognize text, and have it read to you.

A short press of the red Capture button freezes the image on the screen as a snapshot. With a long press of the Capture button, you can save a page, recognize the text on it, and have it read to you.

## RUBY 10 versus RUBY 10 Speech

If you received a RUBY 10 model rather than a RUBY 10 Speech model, then speech functionality is unavailable in your device. Menus and controls for voice and speech are not found on your RUBY 10 screen. You should ignore all mention of voices, speech, and reading aloud in this manual. You also do not have the text recognition feature (also called optical character recognition or OCR) so you cannot scan an image and convert it to text.

If you have RUBY 10 Speech and because of your locale, you select a language without an available voice, or a voice has not been installed, the feature to define the menu voice is hidden. However, you can select another language to use for the reading voice, which is separate from the menu voice.

## Help Text



Help text assists you in learning to use RUBY 10 and make the most of its features. When you press a button or on-screen control for three to four seconds, help text is displayed and/or spoken, describing what you are about to do.

For example, pressing the blue Color Mode button for about three seconds results in information about this button scrolling across the top of the screen. Pressing the **Main Menu** button for three seconds, as shown in the following drawing, results in “Open Main Menu” displayed on the screen.

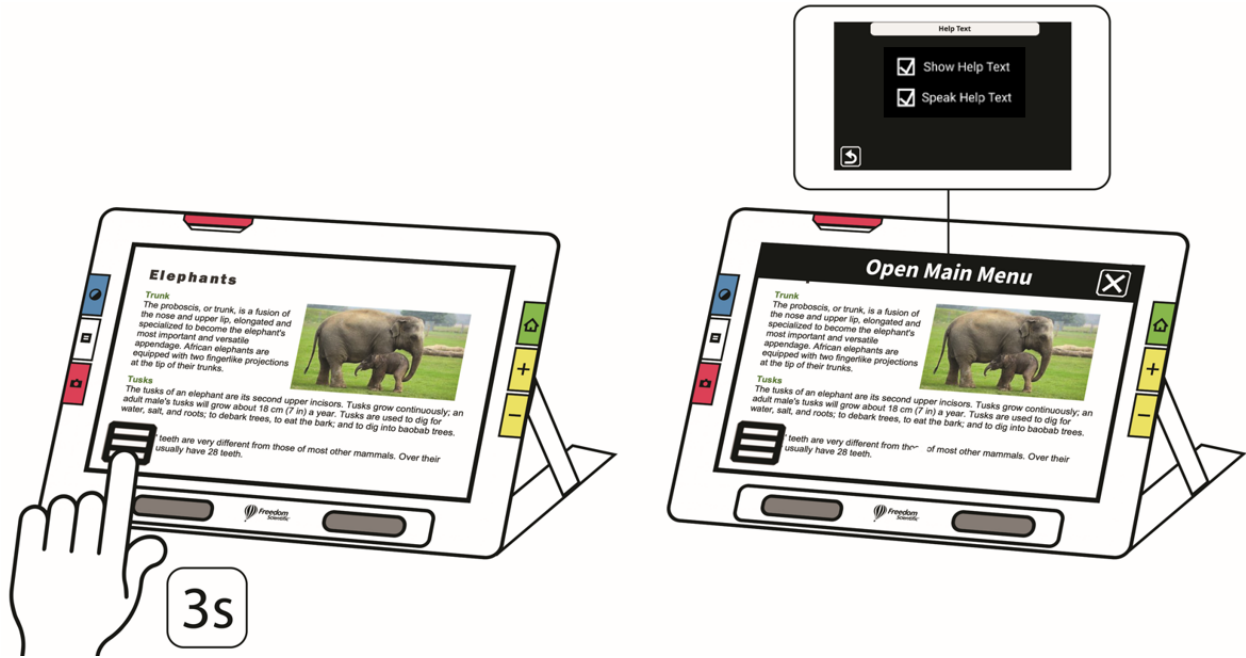

You can close the help by tapping the **Cancel** button to the right of the text box.

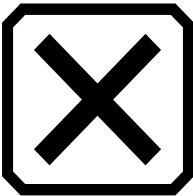

---

**RUBY 10 Speech only:** If you want to have the help text spoken:

1. Tap the screen to display the on-screen buttons.
2. Tap the **Main Menu** button.

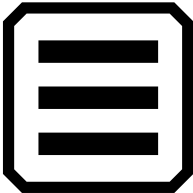

3. Once in the Main Menu, go to **Settings Menu > Language Menu > Help Text**.



4. On the **Help Text** screen, tap one or both checkboxes to display and/or listen to help text. The same text is spoken if you check **Speak Help Text** on the **Help Text** screen.



## Views

RUBY 10 works differently depending on which view you are using. In Live view, you can achieve both a magnified and improved view of the environment and prepare the camera to take a clear snapshot. Go to Live view at any time by pressing the green Live View button.

A short press of the red Capture button freezes the image on the screen as a snapshot.



You can drag a snapshot to see parts of the image that are outside the screen's boundaries. If you take a snapshot of a shirt, for example, you can zoom in to magnify the label, then drag the image up or down to view the stitching or other clothing details. You can pan the image in any direction until the end of the snapshot.

---

## ***RUBY 10 SPEECH ONLY***

---

A long press of the Capture button saves a page, recognizes the text on it, and has it read to you

When viewing text that has been captured and scanned, or when viewing an imported document file (RTF, PDF, or DocX), you are in Document view. Document view includes Image, Teleprompter, or Tickertape mode. Examples are provided below.

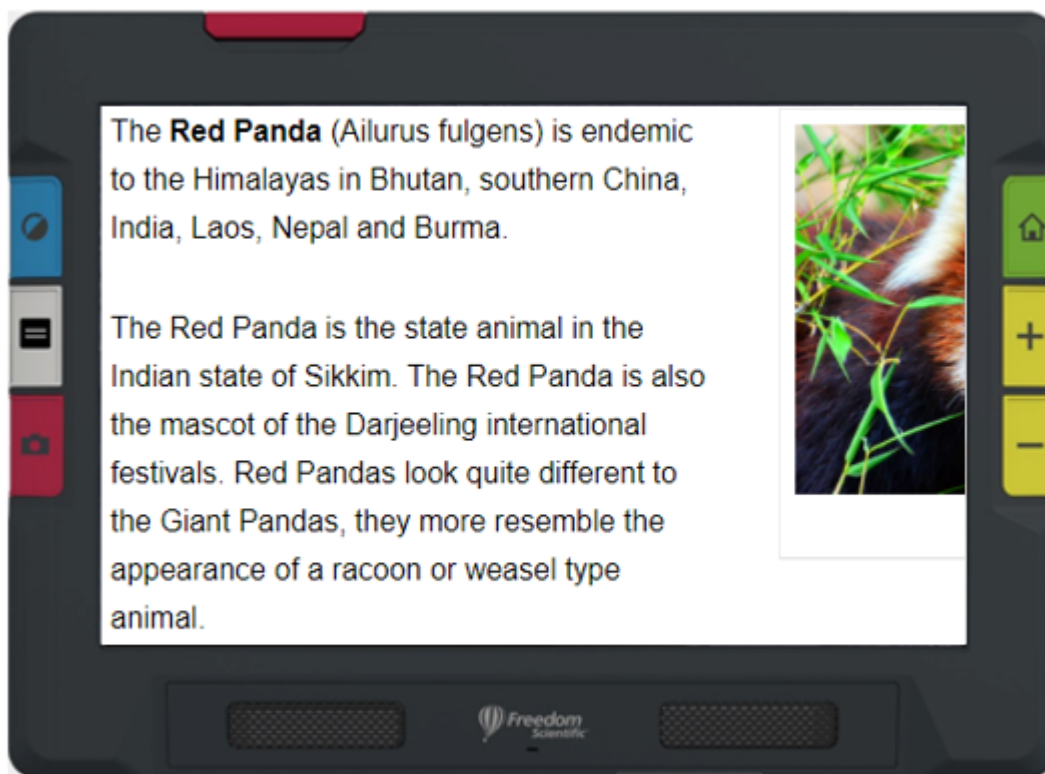

*Example of Image mode*

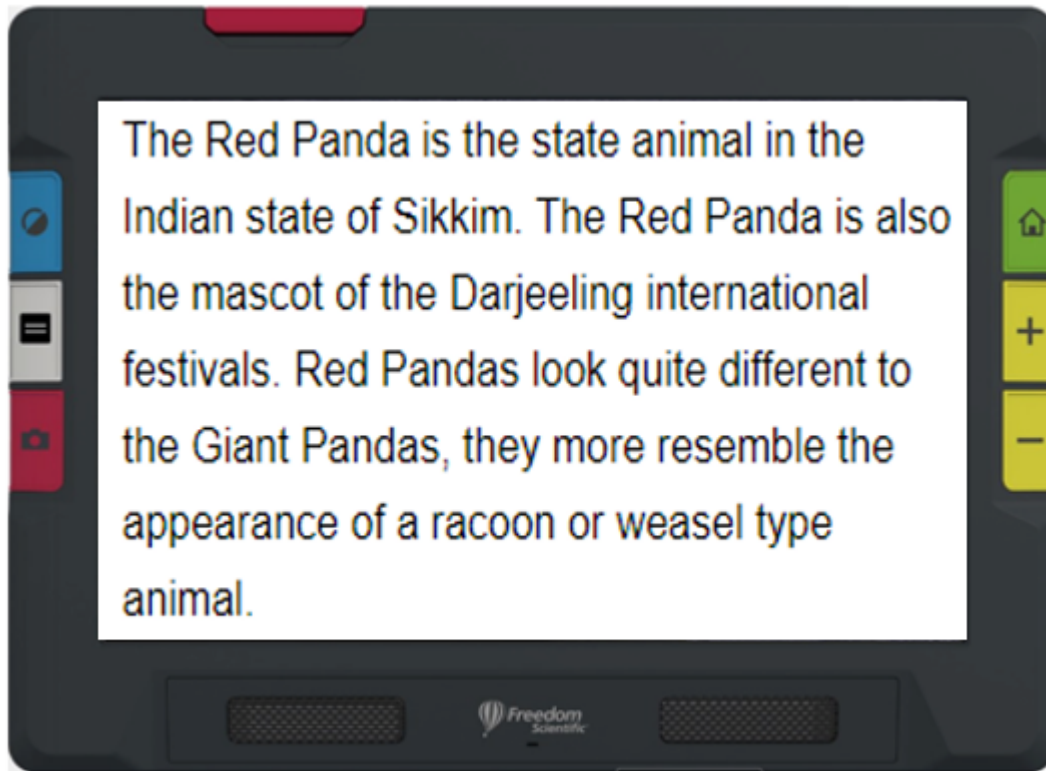

*Example of Teleprompter mode*





*Example of Tickertape mode*

---

## Physical Buttons

The following illustration shows a graphical display of the hardware buttons to explain how they work. The table below the graphic provides more detail about each button.

A long press, as shown in this illustration, means pressing the button about one second before releasing it, as opposed to a short press, which means pressing and immediately releasing the button.

**Tip:** When in Live view, you can press the blue Color Mode button for about a second, then when you release it, the screen displays in full color. The screen color does not change until you release the Color Mode button.

**Short press:**

rotate through configured color modes  
**Long press:** in Live view only, displays full color

**Live view:**

toggle lines and masks

**Document view:**

toggle teleprompter, tickertape, image, and zone modes

**Short press:**

capture image

**Long press:**

capture, scan, and read text

Push up to raise camera arm.  
Fully extend to use full-page camera









Go to Live view, where device screen displays image seen by current camera

**Press and hold:** continuously increase/decrease magnification

**Press and release:** incrementally increase/decrease magnification

Pinch to zoom on touch screen to increase or decrease magnification

Button	Name	Color	Location	Description
	Power	Orange	Left side of device	Press to power on the device. Short press to put on standby. Long press to power off.
	Color Mode	Blue	Top left	Short press rotates through configured color combinations used in the display.  Long press displays full color in Live view only (not in menus, snapshots or documents).
	Text Mode	Gray	Middle left	Toggle lines and masks in Live view. Toggle between teleprompter, tickertape, image, and zone modes in document view.
	Capture	Red	Bottom left	Short press captures the current image on the screen.  Long press both captures and recognizes the text in the capture.
	Live View	Green	Top right	Activates the camera so that whatever the camera is pointed at is displayed on the screen.
	Zoom In/Out	Yellow	Middle and bottom right	Press and hold for continuous magnification, press and release to incrementally magnify, or pinch to zoom on touch screen to increase or decrease magnification.

## On-screen Buttons

Touch the screen to display the on-screen buttons. These buttons take you to menus and screens where you can configure the device to best meet your needs.

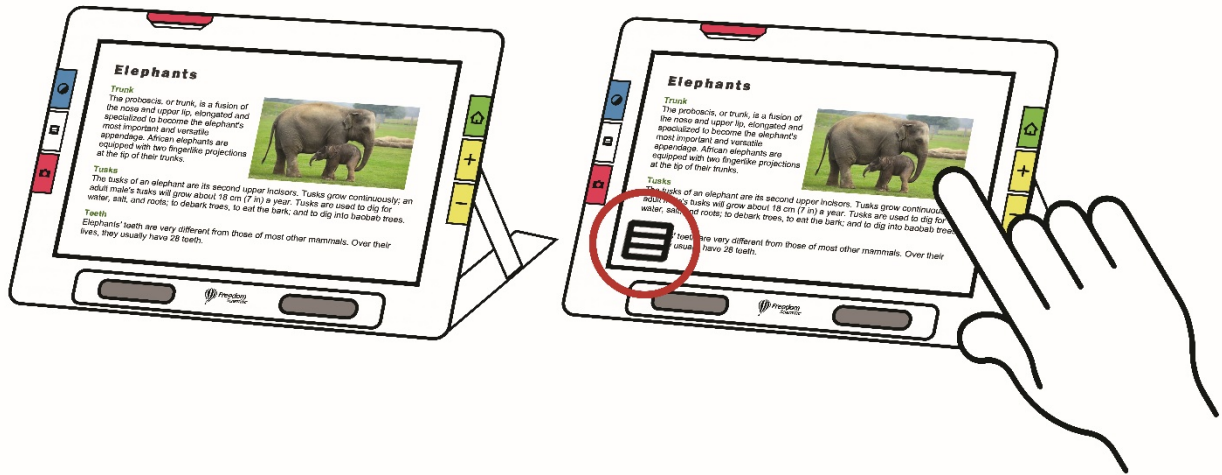

The buttons displayed depend on your view. Buttons are described in applicable sections. For example, the buttons displayed when you open a file are described in the Managing Files section.

The available buttons also are dependent on whether you are in Default mode or Advanced mode. More capabilities are offered in Advanced mode. See [Default Mode and Advanced Mode](#) to learn how to use these modes.

## Display Options

You can display video in full color, high contrast, or grayscale. These features are used to enhance images:

- Color blindness correction to optimize colors for best viewing by individuals who are color blind
- Contrast normalization to balance color and grayscale image viewing
- Dynamic contrast to make text more visible from the background
- Brightness sensitivity to adjust color for individuals sensitive to high brightness
- Edge smoothing, edge highlighting, and edge only mode

See [Color, Contrast, and Clarity](#) on page 44 to learn how to use these settings to display the image best suited to your eyesight.

## Touch Screen

The touch screen gives you a simple way to perform functions in RUBY 10 by directly interacting with the LCD screen.

- Tap on the screen to focus the camera and to display the on-screen buttons.
- Tap buttons and icons to navigate through menus and dialog boxes and to perform functions.
- Select options by scrolling through lists until the option you want is centered in the screen where it is emphasized.
- Pinch to zoom on touch screen to increase or decrease magnification: Place two fingers together on the screen, then spread them out to increase magnification and see more detail in part of the image. Place two fingers apart and pull them together to decrease magnification and see more of the image.



## Menus

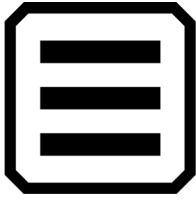

Menus are displayed by tapping the **Main Menu** button.

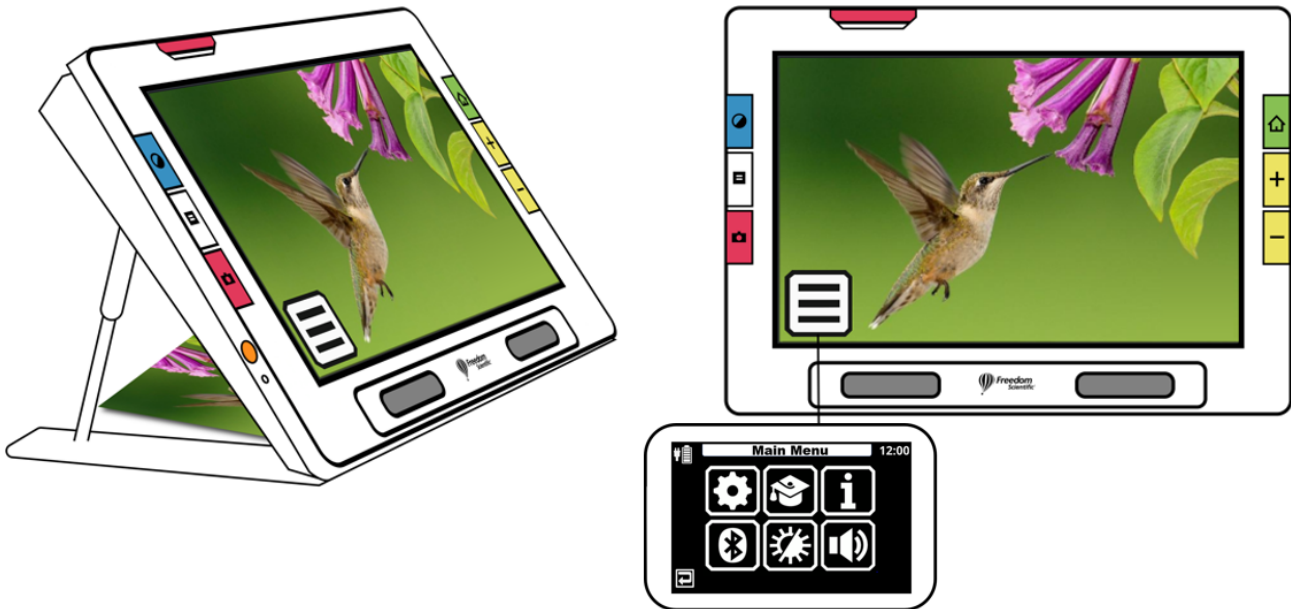

To move through previous menus, you can tap the **Back** button.



Press the green Live View button to leave the menus entirely.

## Tactile Response



For immediate feedback confirming your actions, RUBY 10 can vibrate briefly when you press a physical button or tap a software control (e.g., a checkbox, radio button, toggle switch, icon, or on-screen button).

To turn on this tactile response:

1. Tap the screen to display on-screen buttons, then go to **Main Menu > System Menu**.
2. Tap the **Touch Vibration** icon to enable it.

## Default Mode and Advanced Mode



Your device is set to Default mode when you first use it. Default mode presents a limited, easy-to-use user interface that provides the core features that most users want. Once you become familiar with RUBY 10, you may wish to try out Advanced mode, which offers more functionality.

To change to Advanced mode, tap the screen to display the on-screen buttons, then go to **Main Menu > Advanced Mode**.

**Note:** If your device does not have the **Advanced Mode** icon and you want to use this mode, contact your point of purchase.

### Default Mode

In Default mode, you cannot perform these functions:

- Save a file
- Capture or update multipage documents
- Connect via Miracast
- Manage files
  - Import or export documents
  - Create text files
  - Maintain device storage



## Default Mode Main Menu

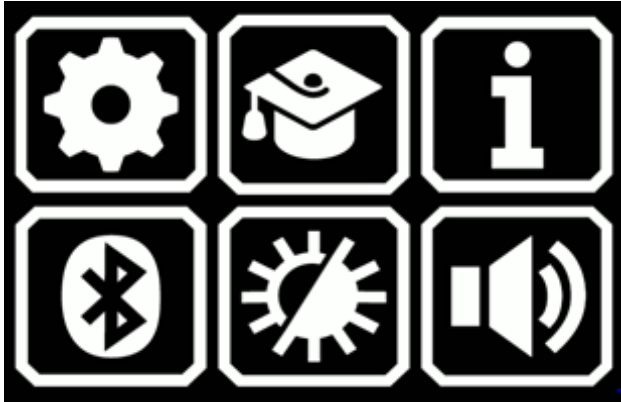

Tap any of the six icons on the Main Menu in Default mode to perform these functions:

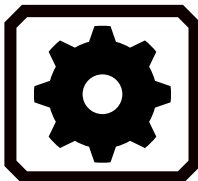

Display the **Settings Menu**.



Go from Default mode to Advanced mode, which is more difficult to use but has more functionality, including multipage document scanning, file management, and Miracast.



Display facts about your device, including software version, product serial number, and technical support contact information.

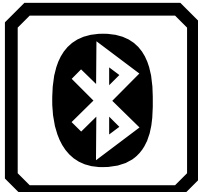

Connect to Bluetooth using a wireless connection.



Change the visual properties to improve the image on the screen.



Adjust the sound settings to increase or decrease the volume.

---

**RUBY 10 Speech only:** Adjust the volume and rate of speech.

---

### ***Default Live View On-screen Buttons***

Buttons display when you tap the screen, and those buttons provide additional features. The buttons are hidden after 10 seconds, but you can tap the screen to display them again.

#### *Overview Camera*

When you tap the screen while in Default mode using the Overview camera, these buttons are displayed: **Main Menu**, **Light On/Off**, and **Focus Lock On/Off**.

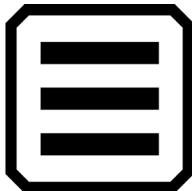

Display main menu.

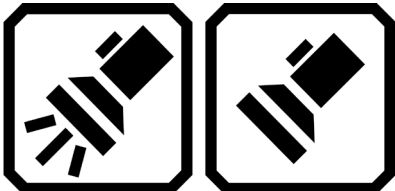

Toggle the light on or off as needed to use the device more efficiently.

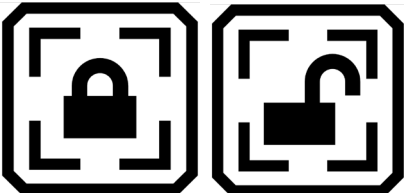

Toggle between locking the focus at its current position or unlocking it. Button on screen reflects the current state.



*Sample showing the buttons that display while using the Overview camera in Default mode*

### *Full-page Camera*

When you tap the screen while in Default mode using the Full-page camera, these buttons are displayed: **Main Menu**, **Light On/Off**, **Focus Lock On/Off**, and **Positioning**.

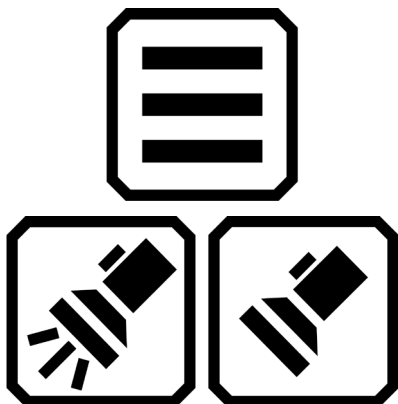

Display main menu.

Toggle the light on or off as needed to use the device more efficiently.

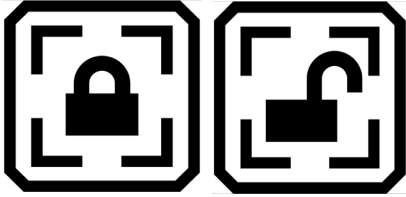

Toggle between locking the focus at its current position or unlocking it. Button on screen reflects the current state.

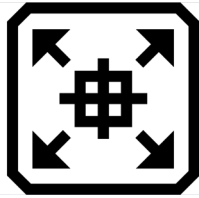

Press and hold to zoom out and display crosshairs on the screen to help you reposition the object under the camera. Release to return to the previous magnification level. You can also use it to hone on a distant object.

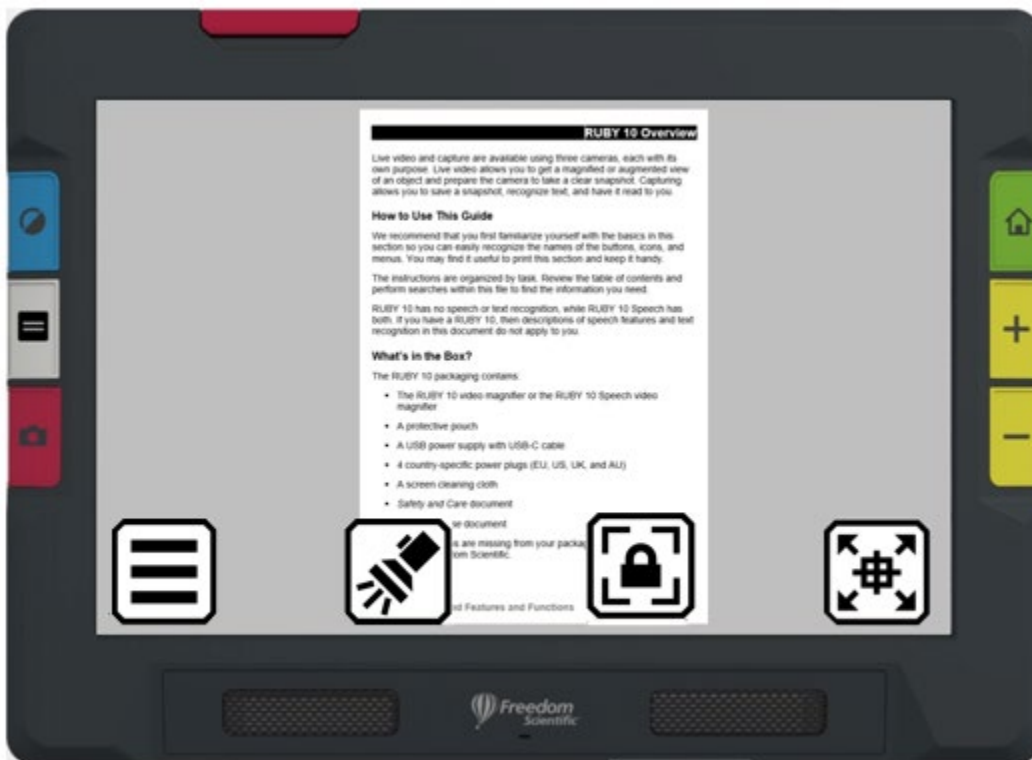

*Sample showing the buttons that display while using the Full-page camera in Default mode*

## *Magnification Camera*

When you tap the screen while in Default mode using the Magnification camera, the **Main Menu** button is displayed.

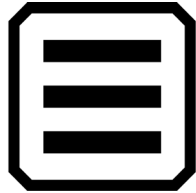

Display main menu.



*Sample showing the button that displays while using the Magnification camera in Default mode*

## Advanced Mode

Advanced mode makes the full functionality of RUBY 10 available to you. Many tools enable you to create vibrant images and documents that are enhanced to be perfect for your unique vision.

Everyone is different, so RUBY 10 gives you the ability to change not only the colors of an image, but also the shadows and edges, the contrast, and the brightness. These tools are available through the hardware and on-screen buttons, as well as through the **Main Menu**.

### *Advanced Mode Main Menu*



Tap any of the eight icons on the **Main Menu** to perform these functions:



Manage document and image files.

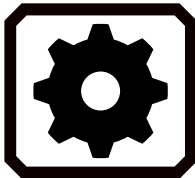

Display the **Settings Menu**, which contains links to other menus that enable you to change the default appearance of images and documents, define reading and menu language and voice, and update system settings.



Go from Advanced mode to Default mode, which is simpler to use but has less functionality. In Default mode, you cannot save files, recognize text, create multi-page documents, or connect via Miracast.



Display information about this device, such as the software version, product serial number, and other data you may need if you require technical support.



Connect RUBY 10 to another device using a Miracast wireless connection.

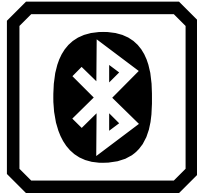

Connect RUBY 10 to another device using a Bluetooth wireless connection.

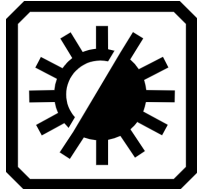

Change the visual properties to improve the image on the screen.

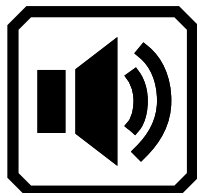

Adjust the sound settings to increase or decrease the volume.

---

**RUBY 10 Speech only:** Adjust both the volume and the rate of speech.

---

### ***Advanced Mode Live View On-screen Buttons***

Buttons display when you tap the screen, and those buttons provide additional features. The buttons are hidden after 10 seconds, but you can tap the screen to display them again.

#### *Overview Camera*

When you tap the screen while in Advanced mode using the Overview camera (neither the stand nor the camera arm are extended), these buttons are displayed: **Main Menu**, **Light**, **Brightness**, **Edge Effects**, **Focus Lock**, and **Dynamic Contrast**.



Display main menu.

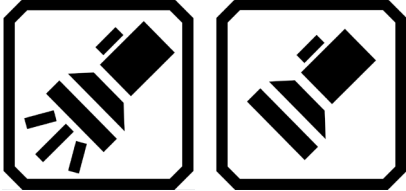

Toggle the light on or off as needed to use the device more efficiently.

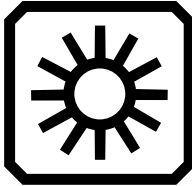

Increase or decrease brightness level of the RUBY 10 display in real time by moving the slider up or down.

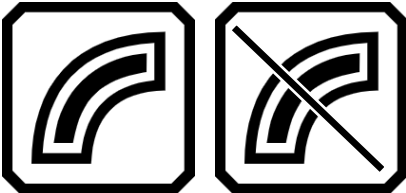

Smooth and highlight edges. When disabled, a diagonal line is displayed across the button.



Smooth edges. High contrast color combinations only.



Show edges only. High contrast color combinations only.

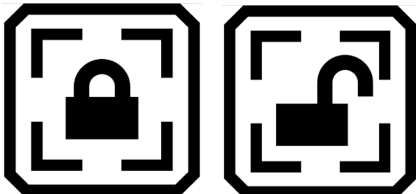

Toggle between locking the focus at its current position or unlocking it. Button reflects the next state.

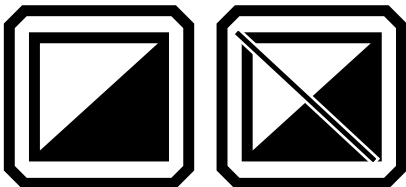

Dynamically adjust and normalize the contrast in images. When disabled, a diagonal line is displayed across the button.





*Sample showing the buttons that display while using the Overview camera in Advanced mode*

## Full-page Camera

When you tap the screen while in Advanced mode using the Full-page camera (both the stand and the camera arm are extended), these buttons are displayed: **Main Menu**, **Light**, **Brightness**, **Positioning**, **Edge Effects**, **Focus Lock**, and **Dynamic Contrast**.

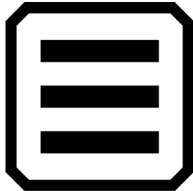

Display main menu.

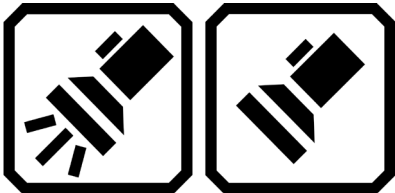

Toggle the light on or off as needed to use the device more efficiently.

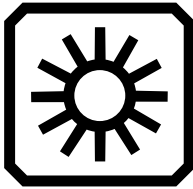

Increase or decrease brightness level of the RUBY 10 display in real time by moving the slider up or down.

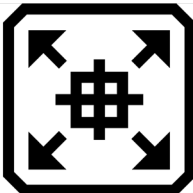

Press and hold to zoom out and display crosshairs on the screen to help you reposition the object under the camera. Release to return to the previous magnification level. You can also use it to hone on a distant object.

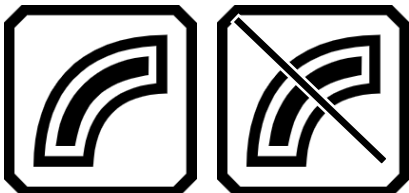

Smooth and highlight edges. When disabled, a diagonal line is displayed across the button.



Smooth edges. High contrast color combinations only.

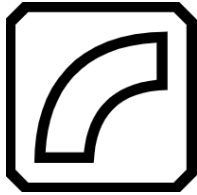

Show edges only. High contrast color combinations only.

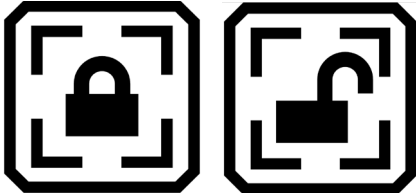

Toggle between locking the focus at its current position or unlocking it. Button reflects the next state.

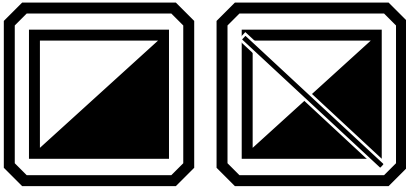

Dynamically adjust and normalize the contrast in images. When disabled, a diagonal line is displayed across the button.



*Sample showing the buttons that display while using the Full-page camera in Advanced mode*

## Magnification Camera

When you tap the screen while in Advanced mode using the Magnification camera (the stand is extended but not the camera arm), these buttons are displayed: **Main Menu**, **Brightness**, **Edge Effects**, and **Dynamic Contrast**.

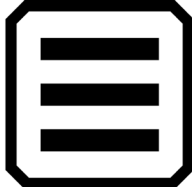

Display main menu.

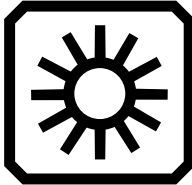

Increase or decrease brightness level of the RUBY 10 display in real time by moving the slider up or down.

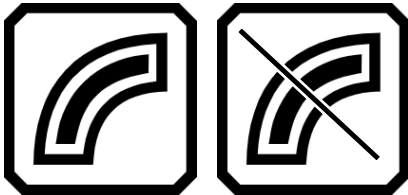

Smooth and highlight edges. When disabled, a diagonal line is displayed across the button.



Show edges only. High contrast color combinations only.



Smooth edges. High contrast color combinations only.

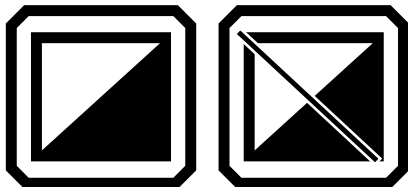

Dynamically adjust and normalize the contrast in images. When disabled, a diagonal line is displayed across the button.



*Sample showing the buttons that display while using the Magnification camera in Advanced mode*

## Cameras

Cameras enable you to view objects in Live view, take snapshots, enhance images, and save them. RUBY 10 has three cameras, each serving a specific task or situation. Only one camera is active at a time, and its associated light is only enabled if it is active.

The availability of the cameras depends on the position of the integrated reading stand and the swing-out camera arm. All cameras can be used in both Default mode and Advanced mode.

Three cameras and the camera arm enable you to use RUBY 10 in different ways, as described in the following table.

Camera	Location	RUBY 10 Position	Purpose
<i>Magnification camera</i> , min 2x to 24x	Center of the body facing downward. Blocked if the stand is closed.	Stand is open and the camera arm is closed.	Reading on a desk or table. Put document beneath RUBY 10.
<i>Overview camera</i> , min 1.8x to 22x	Center of the body. Partially blocked if the stand is open.	Both the stand and the camera arm are closed.	Spotting objects while holding the device, such as while shopping.
<i>Full-page camera</i> , min 0.4x to 13x	At the end of the arm	Stand is open and the camera arm is fully extended.	Read and capture full-page document images, write your signature, or view other objects like photos. Good for hobbies.

From minimum zoom to maximum zoom takes five seconds for each camera. You can display an image in full color, high contrast, or grayscale.

## Magnification Camera



The Magnification camera is used for reading on a desk or table. You must place the device on top of reading material, so leave the camera arm closed and extend the stand. The light is always on in this mode due to the darkness beneath the device.

1. Extend the stand.
  - a. Hold the device upright with the bottom edge stabilized against a desk.
  - b. Curl your fingers around the unit and push out the stand until it is fully extended and clicks into place.
  - c. Gently set the unit down on the stand.

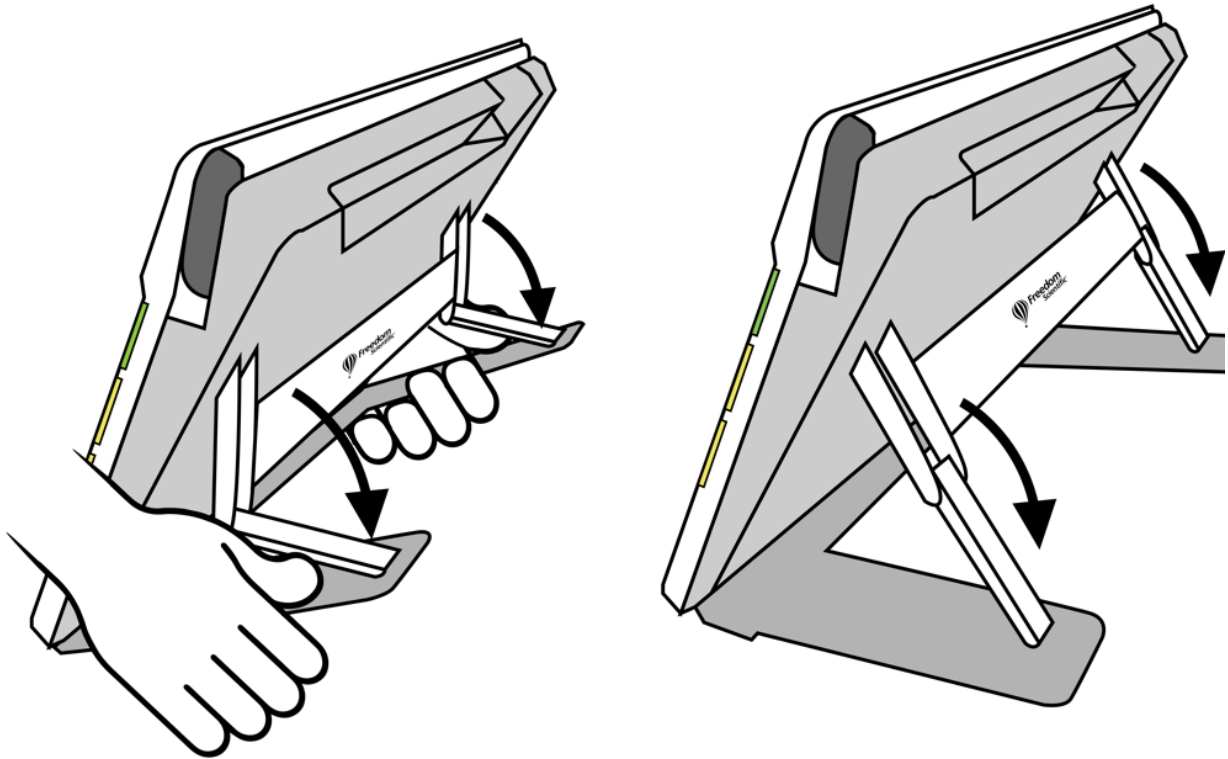

2. Put the material you want to view beneath RUBY 10 until it is centered on the screen.
3. Optionally, enhance the image using the yellow Zoom In/Out buttons or blue Color Mode button.
4. Optionally, press the red Capture button to take a snapshot. Press the green Live View button to return to the Live view.

## Overview Camera

The Overview camera is ideal for spotting labels, price tags, receipts, business cards, and more while carrying the device. You can use it to view objects several feet away.





To use the Overview camera:

1. Close the reading stand by pressing the Freedom Scientific logo on the bar found on the back of the device.

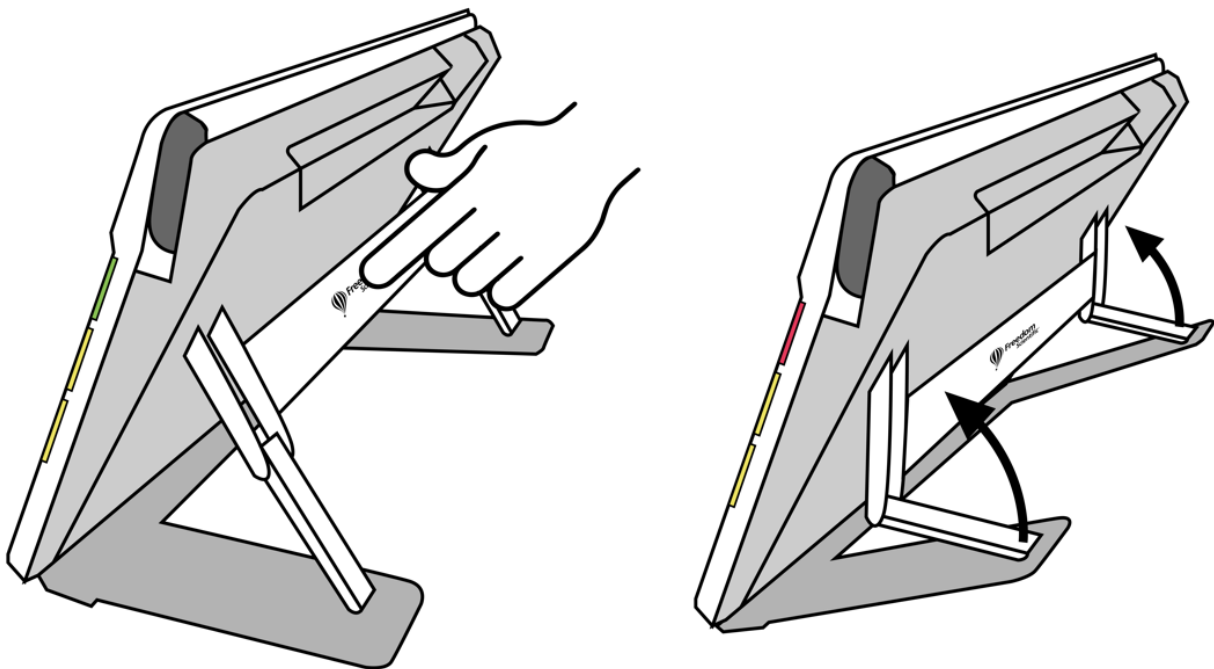

2. Close the camera arm until it flush against the top of the device.
3. Point the camera at what you want to view.
4. Optionally, enhance the image using the yellow Zoom In/Out buttons or blue Color Mode button.
5. Optionally, tap the screen to display buttons at the bottom of the screen. Using these buttons, you can display the Main Menu, turn on/off the light, or enable/disable focus lock.
6. Optionally, press the red Capture button to take a snapshot. Press the green Live View button to return to the Live view.

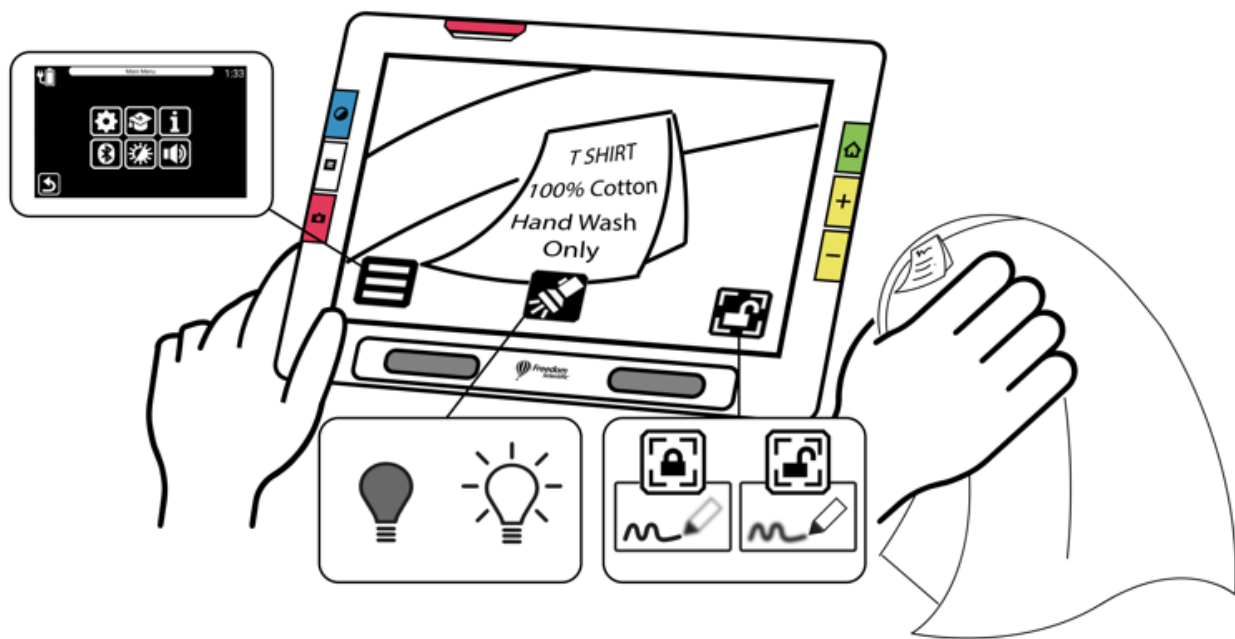

## Full-page Camera



When the swing-out camera arm is opened and the stand is extended, the camera on it can be used to read and scan printed materials or write your signature without being restricted in your movements. You could also use this camera to work on hobbies, such as painting.

To use the Full-page camera:

1. [Open the stand.](#)
2. Fully extend the camera arm.
  - a. Push up on orange tab at top of unit until the camera arm begins to slide out.
  - b. Pull up to extend the camera arm.
  - c. Continue pulling to the right until the camera arm is fully extended. The arm must be fully extended to use the Full-page camera.

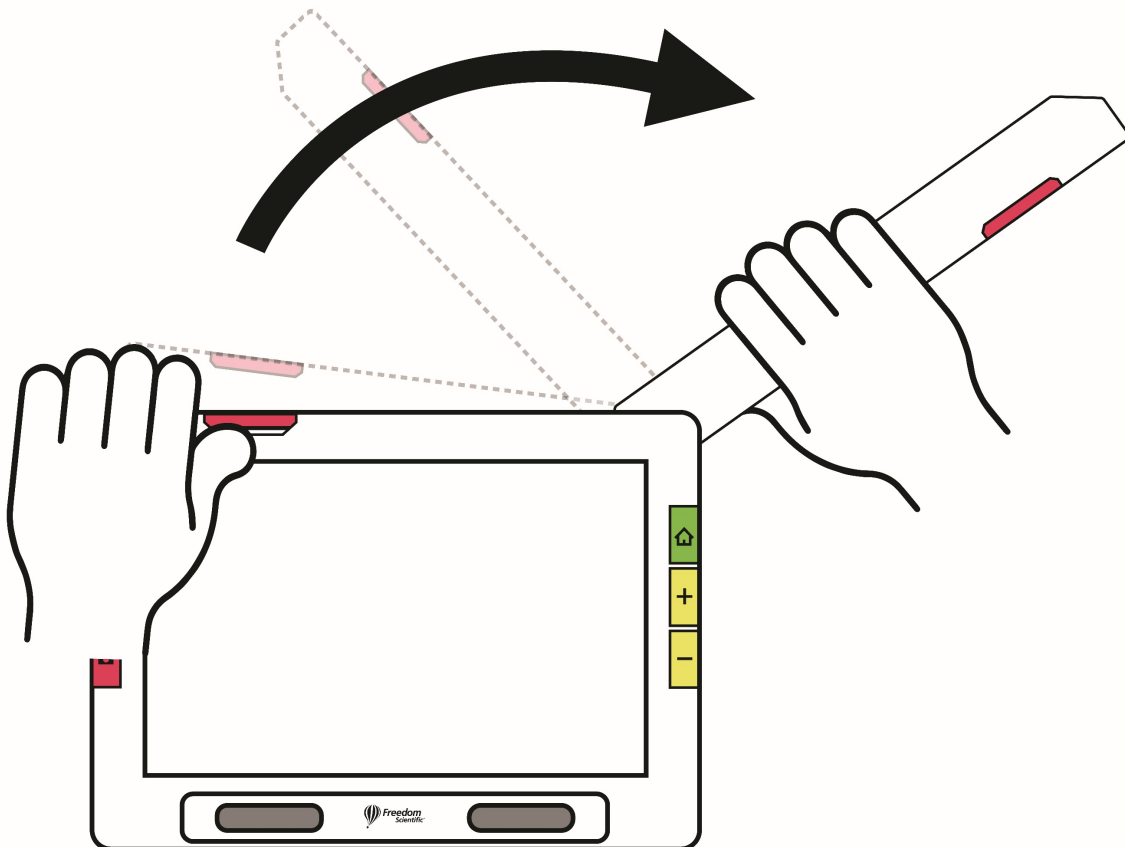

3. Lay your document flat on the desk to the right of the device beneath the camera.
4. Move the document as needed to fit the content in the gray camera frame. For hobbies, hold objects at a comfortable distance in front of the camera. For writing, you can watch your hands on the display.

5. Optionally, select the best color combination using the blue Color Mode button, and increase or decrease magnification using the yellow Zoom In/Out buttons.
6. Optionally, tap the screen to show the available icons. These icons enable you to display the **Main Menu**, turn on/off the Light, enable/disable focus lock, or position the object under the camera using the crosshairs that display (left to right in the following illustration).

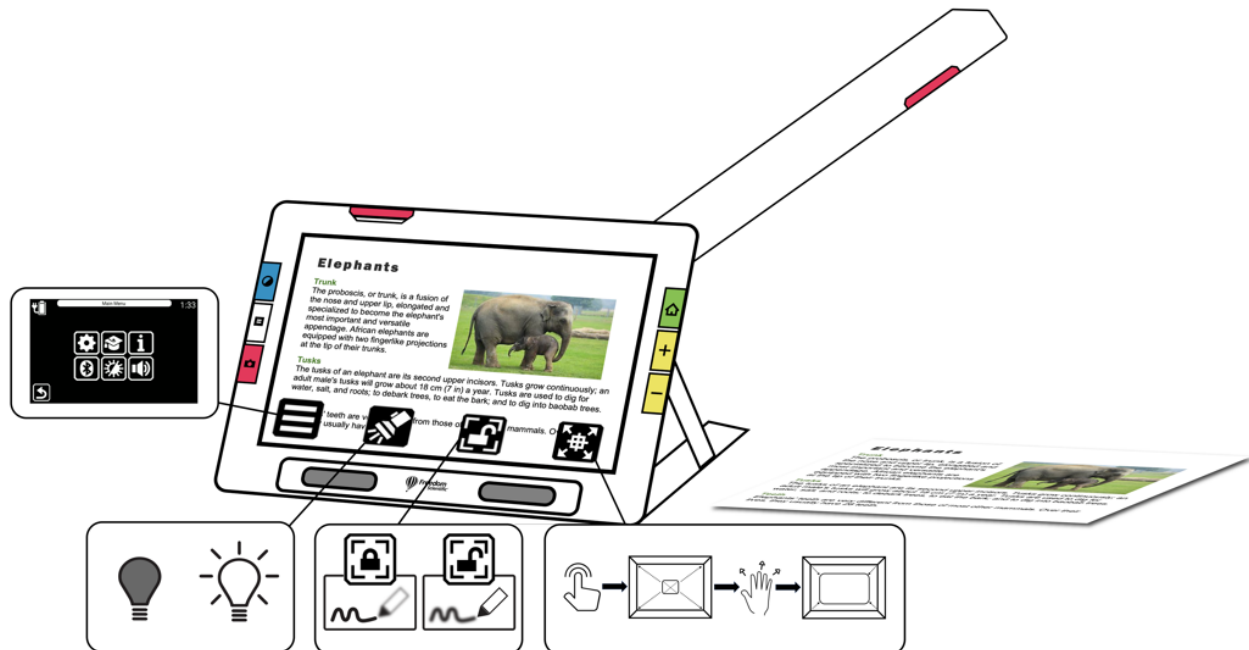

- 
7. **RUBY 10 Speech only:** Perform text recognition of a document and have it read to you by pressing and holding the red **Camera** button for one second (longer than when you take a snapshot).
- 

## Reading

Place your page to the right of the device until it fills the screen. Press the red Capture button for about one second until the screen displays a camera. The text is recognized and read to you.

**Tip:** If your document is not read to you, check your volume level and ensure your reading language is set correctly. If the text seems to be read inaccurately, try repositioning the document or improving the lighting in the environment. You can also use edge effects to make the lighting more even.

## Writing

Place your paper beside the device, then write on it while watching yourself on the screen.



Before placing your hand under the camera, enable focus lock so the camera focuses on the paper instead of your hand.

Tap the **Focus Lock** button to toggle between locked and unlocked.



## Hobbies

Hold the object(s), such as your canvas and brushes when painting, to the right of the device until you see the appropriate image on the screen.

Live camera view is the default. In Live view, you can achieve both a magnified and improved view and prepare the camera to take a clear snapshot. Press the green Live View button to enter Live view.

### Magnifying an Image in Live View

Press and hold the top yellow Zoom In button or the bottom yellow Zoom Out button on the right side of the RUBY 10 body for continuous zoom magnification. Press and release to incrementally increase or decrease magnification. Both continuous and incremental magnification are available for live, frozen, and saved images.



When the stand is open and focus lock is disabled, the camera automatically stabilizes the image. If no motion is detected, the image is frozen so it is easier to read.



## Color Modes

Press the blue Color Mode button on the left side of RUBY 10 to cycle through true color, grayscale, and your choice of color combinations. Color modes can be applied during Live view or after an image has been saved.

## Tap to Focus and Show/Hide On-screen Buttons

In any position, you can tap the screen to focus on one part of the picture. Automatic focus occurs regardless of whether focus lock is on or off. Tapping the screen also displays the on-screen buttons.

## Focus Lock

The **Focus Lock** button is available when using the Overview camera and the Full-page camera. Tapping this button locks the focus at its current position, while tapping it again unlocks it.

## Light

A light comes on automatically when using any camera. However, you can turn the light off or on by tapping the **Light** button. The availability of this button depends on the mode and camera used.

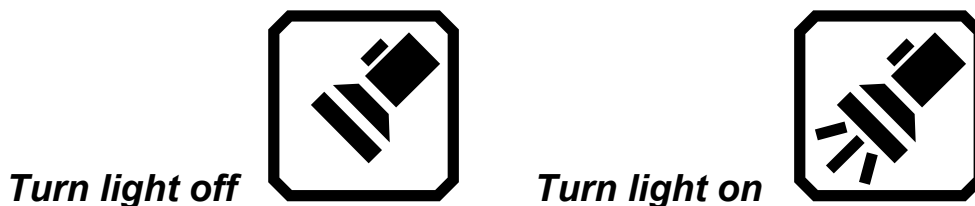

When lights come on, they brighten gradually, reaching full strength in about five seconds to reduce eye strain. For heat protection, the power supplied to the lights is based on the temperature of the device.

## Lines and Masks

You can toggle between lines and masks by pressing the gray Text Mode button. Both help you keep your place on the screen. To move a line, drag it on the touch screen. To change the size of the masked area, drag the boundary. A short press of the Text Mode button returns to normal view.



## Taking a Snapshot

Press the red Capture button briefly to take a picture of the current image. Press the green Live View button to return to live video.

Taking a snapshot can be useful for reading labels on items on a store shelf. For example, you can move RUBY 10 close to items and take a snapshot, then bring RUBY 10 close enough for you to read the labels on the RUBY 10 screen.

Optionally, press the yellow Zoom In button to increase the magnification of the snapshot, or the Zoom Out button to decrease magnification.

Press the blue Color Mode button to display the snapshot in different color combinations. For more information on improving the quality of images, see [Color, Contrast, and Clarity](#).

## Color, Contrast, and Clarity

You have many ways to improve the visual acuity of images and text. Features used to change the way images are displayed and captured include:

- Color modes
- Brightness sensitivity settings
- Color blindness modes (protanopia, deuteranopia, tritanopia)
- Edge enhancements, edge smoothing, or edge-only mode
- Contrast settings

Some features can be toggled by tapping a button on the screen, while others must be enabled using menus. Menus are also used to determine the way images and text are displayed by default.

The **Appearance Menu** is used to modify the way RUBY 10 displays menus, images, and text. To change the way RUBY 10 appears, tap the screen to display on-screen buttons, then go to **Main Menu > Settings Menu > Appearance Menu**.



The **Appearance** menu offers ways to change the way your screen looks and the way the camera projects what is seen. The four icons on this menu display screens that are used to change the appearance of text and images:

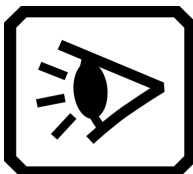

The **Viewing Modes** screen enables you to change the way text is displayed by default. See [Viewing Modes](#) for information on this screen.

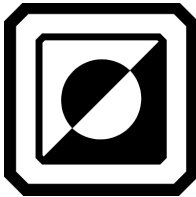

The **Color Combinations** screen allows you to determine the color combinations included in the rotation when you press the blue Color Mode button. You can determine one set of colors for menus and text and another set for images. Neither true color nor grayscale is a choice for displaying menus or text files (defined on the **Text** tab). The default for displaying the menus is light gray on black, but you can change these colors by adding any combination that works best for you. See [Color Combinations](#) for more information.



The **Visual Display Settings** screen offers a light sensitivity filter (enabled by default) and color blindness filter (no filter by default).

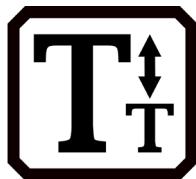

The **Font Size** screen enables you to change the size of the letters used to display text. The size is set to 28 points by default, but this screen allows you to select the font size that is best for you.

## Color Combinations

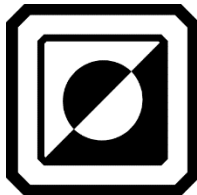

You can build two unique sets of color combinations that are always available using the blue Color Mode button. One set is for text, the other for images.

### ***Text Color Combinations***

One set of color combinations is used to display text:

- The system interface, including menus, screens, buttons, and help text.

- 
- **Advanced mode only:** Document views, including Tickertape mode, Teleprompter mode, text files that have been imported, or text files that have been created when you scanned a file where text was recognized.
- 

## ***Image Color Combinations***

A separate set of color combinations is used to display images, including Live view, Snapshot view, and Zone view. True color and grayscale are always available for images. High contrast blends are up to you.

- True color matches the real-life image. You can add optional effects to change the brightness, how the colors are presented, and to enhance the contrast and clarity. In Live view, a long press of the Color Mode button changes the color combination to true color.
- In grayscale, the document is shown in black, white, and shades of gray.
- High contrast blends colors to differentiate the background and the foreground, and to accentuate the features of the image.

## ***Adding Color Combinations***

The **Color Combinations** screen displays the color combinations that will be included in the rotation when you press the blue Color Mode button. The available color combinations are up to you, although defaults are provided.

The **Color Combinations** screen has two tabs. On the **Text** tab, you set the rotation of color combinations for the RUBY 10 menus and text documents, such as saved files where you have used text recognition, and the **Image** tab, which includes live view, snapshots, saved captures, and a zone or image view of a document. You can change the selected color combination at any time.

To add a color combination:

1. Tap the screen to display the on-screen buttons.
2. Go to **Main Menu > Settings Menu > Appearance Menu > Color Combinations**.

3. Tap the upper left **Plus** button.

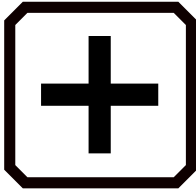

4. On the **Add Color Combinations** screen, scroll to select the color combination you wish to add. The selected colors are shown in rectangles, such as black on red.

**Note:** Optionally, press the left middle button to invert the currently selected color combination, such as changing black on red to red on black.

5. To add the color combination, tap the plus sign again. A confirmation message is displayed.
6. Continue adding all the color combinations that you want in the rotation.
7. Tap the **Back** button at the bottom left to return to the **Color Modes** screen. Review the color combinations to ensure you have the ones you want in the rotation.
  - To remove a color combination, tap the trash can button, which is the second from the top on the left.
  - To add another color combination, return to step 3.
8. When you are satisfied with the color combinations in the rotation, tap the **Back** button or press the green Live View button.

**Note:** Although you have countless color combinations available to you, keep in mind how long it will take to rotate through them. If you want to display in full color, for example, you probably will not want to press the Color Mode button 20 times to get to it.

## Visual Display Settings



RUBY 10 offers a light sensitivity filter and three color blindness correction filters to users with varying eye conditions. To display these visual display settings, tap the screen to display the on-screen buttons, then go to **Main Menu > Settings Menu > Appearance > Visual Display Settings**.

Two fields on this screen enable you to improve how the image is displayed: the **Light Sensitivity Filter** and the **Color Blindness Filter**.

### *Light Sensitivity Filter*

Enabled by default, the **Light Sensitivity Filter** mutes the lighting of very bright colors to allow for eye conditions where bright light makes it difficult to read. For example, white might be shown as a light gray.



To disable it, slide the toggle to the left.



Rather than changing the overall brightness of the display screen, this setting changes how bright colors are presented in images.

### *Color Blindness Filter*

RUBY 10 offers three color blindness correction filters to improve contrast between colors. For example, one filter changes reds to pinks, which is a color better recognized by users affected by protanopia. These filters are applied to colors in the menus and all views, including Live view, Snapshot view, and all Document views.

To enable the **Color Blindness Filter**, tap the **Edit** button to the right of the current setting.

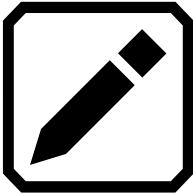

On the **Color Blindness Filter** screen that displays, select the option that appears to be a solid gray rectangle. If none appear to be solid gray, then select **No Filter**. After selecting one of the four options, tap the **Back** button.

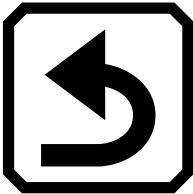

The setting under **Color Blindness Filter** reflects the option that you selected. The setting is immediately applied.

## Visual Properties

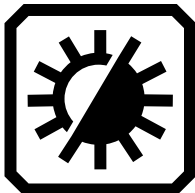

To globally change the way images are displayed, tap the screen to display the on-screen buttons, then go to **Main Menu > Visual Properties**.

On the **Visual Properties** screen, you can adjust the contrast, highlight and smooth edges, and adjust screen brightness. Problems that visual properties compensate for might include a crinkled or yellowed page, shadows, ink smears, or book creases.

## ***Brightness***

Use the left slider on the screen to control the screen brightness. Move the slider up to brighten the screen.

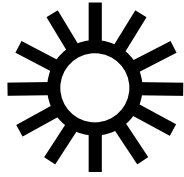

Move the slider down to darken the screen.



## ***Contrast***

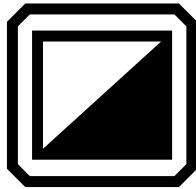

Tap the **Contrast** button to enable this function and display a slider beneath the button. Contrast can be adjusted in Live view, Snapshot view, Image view, or Zone view.

**Note:** Image quality can vary widely based on ambient lighting conditions and the document being imaged.

Move the slider up to increase contrast in full color and grayscale. With high contrast colors, move the slider up for more background color and less foreground color.





Move the slider down to decrease contrast in full color and grayscale. With high contrast colors, move the slider down for less background color and more foreground color.

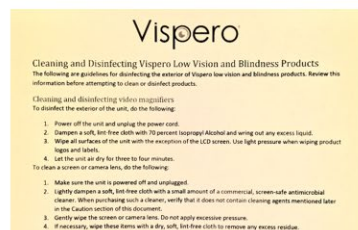
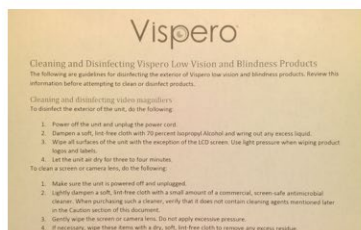
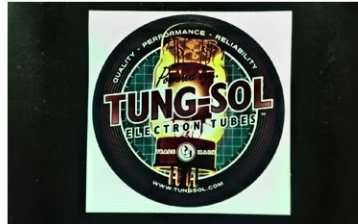

*Examples of contrast adjustments: left, no adjustments were made; center, full color is enhanced, right, high contrast colors are enhanced*

**Tip:** It is recommended that you use trial and error to see the real-time difference as you move the slider up and down.

## Edge Effects

Edge effects give you a unique approach to displaying images. Toggle the **Edge Effects** button and use the corresponding slider to smooth the edges within images, display edges only, or highlight the edges.

This feature is available in Live view, Snapshot view, Image view, and Zone view. Edge effects are global and saved for each camera orientation: Magnification, Overview, and Full-page.

Tap the **Edge Effects** button to toggle to the desired approach.

Long press the **Edge Effects** button to go straight to the control window where you can use the slider to adjust the edge effects settings.



Highlight the edges within the image. Available in high contrast colors, true color, and grayscale. See sample below.

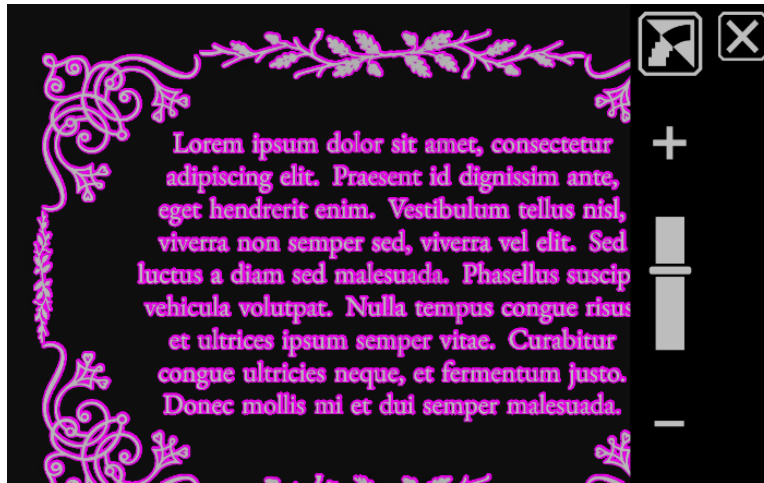

*High contrast with edge highlighting. Tap the toggle button above the slider to show the image with edge smoothing.*

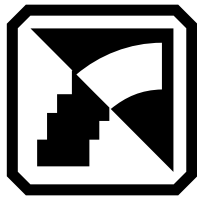

Smooth the edges within an image. The outline is enhanced using the same color as the image. Not available for full color or grayscale. Available in high contrast colors only.

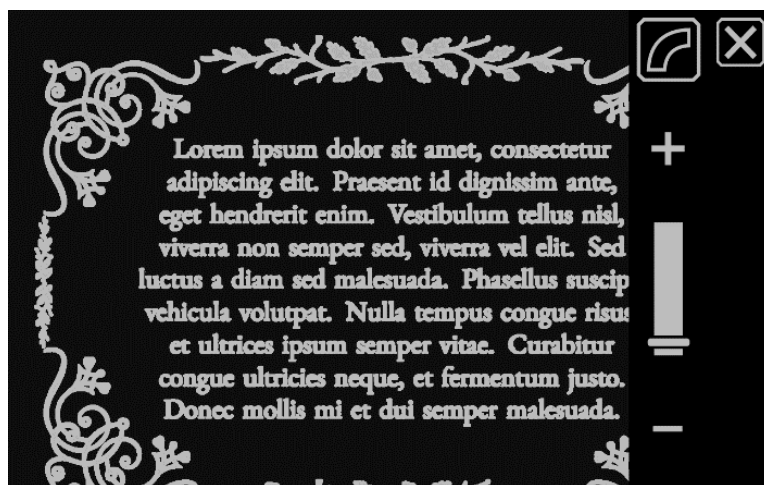

*High contrast colors with edge smoothing. Tap the toggle button to show the image with edges only.*



Show only the edges within an image. Not available for full color or grayscale. Available in high contrast colors only.

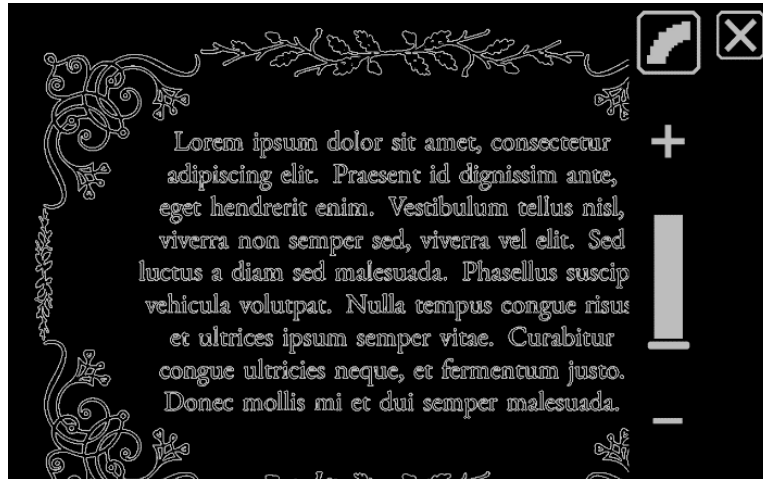

*High contrast colors with edges only. Tap the toggle button to show the image with no edge effects.*



Do not apply any edge effects. Available in any color mode. See samples below.

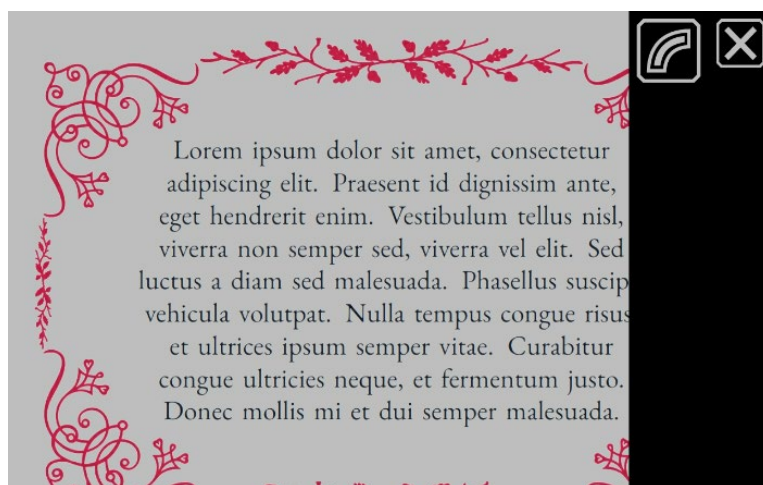

*Full color image with no edge effects. Tap the toggle button to show the image with edge highlighting.*

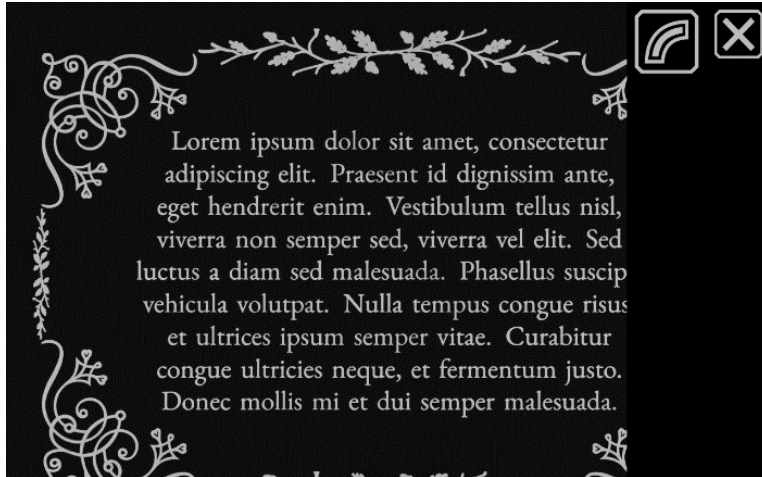

*High contrast image with no edge effects. Tap the toggle button to show the image with edge highlighting.*

### **Reset Settings**

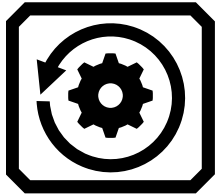

Tap the **Reset Settings** button to reset the contrast and edge effects settings to the default.

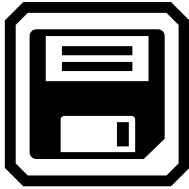

If you have RUBY 10 Speech, your device includes text recognition, also called optical character recognition (OCR), and speech. You can capture an image of a page and RUBY 10 will recognize the text and read it to you. The file is not saved unless you tap the **Save** button, as discussed in the following sections.

### **Capturing a Page**

You can capture images from any position, whether the stand is open or closed or the camera arm is extended or closed.

For a full page of text, however, you need to open the stand and fully extend the camera arm. Place the material you want to capture under the camera arm so the page is centered on the screen. Bold, italics, and underline are recognized. For steps on setting up RUBY 10, see [Full-page Camera](#).

To save a file after it is captured, tap the **Save** button.



### **Capturing Multiple Pages**

With a long press of the red Capture button (about one second), you save a page, recognize the text on it, and have it narrated. You can begin reading before all the text is recognized. Using the Full-page camera is recommended for capturing text. However, you can use any camera to capture an image.

To capture multiple pages:

1. Open the stand and extend the camera arm to use the Full-page camera.
2. In Live view, frame the image on the screen.
3. Press the red Capture button for about one second (a long press). A camera icon is displayed while the image is captured.
4. Tap the **Add Page** button.

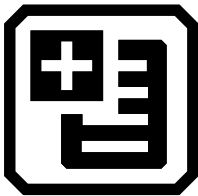

5. Continue adding pages until you are done. Tap the **Preview** button to review the captured pages. If you are unhappy with a scan, you can delete the page and rescan it.

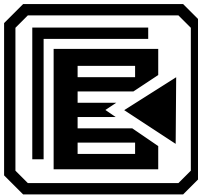

6. If you want to keep the file, tap the **Save** button so you can open it later from File Manager.



7. In the **Record Audio Tag?** screen, tap **Yes** to record a name for the file. See [Recording Audio Tags](#) on page 59 for more information.

**Note:** It is recommended that you name each file so that you recognize the contents when you later look for the file.

## ***Navigating Using the Touch Screen***

You can move to the previous page of a document by panning to the top of a page, then swiping downward on the touch screen. Move to the next page by panning to the bottom of a page, then swiping upward on the touch screen.

## ***Navigating Using Page Numbers***

To move around a multipage document, tap the page number to display a scrolling list of page numbers, then either scroll to the page number you want or tap one of the following buttons:

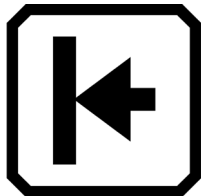

**Start of Document** displays the first page of the document.



**Previous Page** displays the previous page in the sequence of scanned pages.



**Furthest Viewed** displays the furthest location that you have previously viewed. If you have a 10-page document and have viewed the first five pages, for example, then you would jump to page 5.



**Next Page** displays the next page in the sequence of scanned pages.

## ***Changing the Page Order***

You can swap the position of the current page with the previous page using the **Swap Pages** button.



## **Saving a File**

To save a file, tap the screen to display the buttons, then tap the **Save** button.



You are asked if you want to add an audio tag, which is a name for the file. We recommend that you do. See [Recording Audio Tags](#) for more information.

Each text file is saved using the reading language currently selected. When you save and open the file later, the same language and voice is used to read it. However, you can easily change the language. See [Reading Language and Voice](#) for more information.

You also can change the appearance of a capture or before or after saving it by pressing the blue Color Mode button or the yellow Zoom In/Out buttons, or by tapping on-screen buttons. For more information, see [Color, Contrast, and Clarity](#).



## Recording Audio Tags

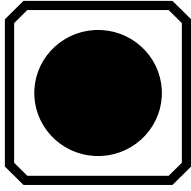

Audio tags help identify your saved files on RUBY 10. You can apply an audio tag to any file that you save or import. However, a file exported to a USB-C flash drive or copied to a computer will not keep its audio tag, so the audio tag is only useful on RUBY 10.

You can add an audio tag when you save a captured image or text file, or later, when you open a saved file.

To see more information about the file and play its audio tag, tap the **Information** button. The file is displayed, and its name is at the top of the screen.

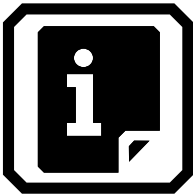

You can change the audio tag using the **Record** button near the top of the screen, just under the file name.



To listen to an audio tag, tap the **Play** button.

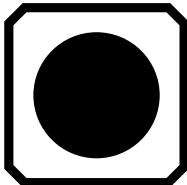

To add or change the audio tag, tap the **Record** button, speak the name of your file, then press the square **Stop** button.

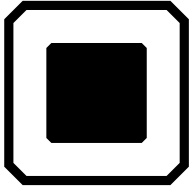

When you are finished speaking the name of the audio tag, tap the **Stop** button.

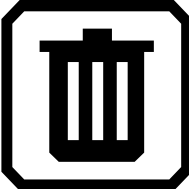

To delete the audio tag, tap the **Delete** button and confirm the deletion by tapping **Yes**.

## Reading Language and Voice



RUBY 10 Speech reads text aloud using the reading language and voice that was set when you scanned the file. It identifies paragraphs and bold, italicized, and underlined text as it reads.

To set the reading language and voice, tap the screen to display the on-screen buttons, then go to **Main Menu > Settings > Reading Settings > Reading Language**. The default is English.

You can set only one language and one voice at a time for reading. If you were studying French, for example, then you could change the reading language to French. When you were ready to switch back to homework in English, you could reset the language to English.

When you open a text file you captured earlier, you hear the same reading language and voice that was set when you saved it. To delete the language and voice saved with the file and revert to the reading language and voice currently set, go to the **Editing File** screen and tap the **Edit** button next to the language.

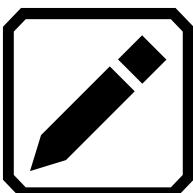

If you open a text file that you imported, the current reading language and voice is used. You cannot change it, so the **Language and Voice** button is not displayed in the **Editing File** screen.

Changing the default reading language and voice does not affect the language and voice saved with each document file.

## Viewing Modes

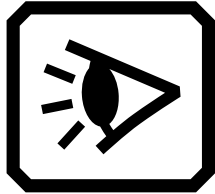

If you open a DOCX or PDF file, or if you open a captured file with recognized text, then the first viewing mode is **Zone** view. With zones, the text is separated by highlighted and numbered boxes to help you navigate around the document.

If you tap the **Play** button, then narration starts at the beginning of the document.

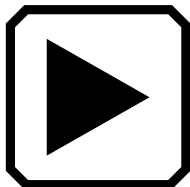

Optionally, you can choose where you want to begin reading by long pressing a zone. In this view, the captured image is in full color. Selecting a color mode changes the zone highlighting and numbering.

### ***Text Mode button***

In a document, you can press the gray Text Mode button to toggle through viewing modes and determine the best way to read the current text. The first viewing mode is set according to the default selected in the **Viewing Modes** screen, where you also set the default highlighting and whether lines or masks are used.

In an image, the gray Text Mode button toggles through lines, masks, or neither.

### ***Viewing Modes Screen***

To change the way recognized text is displayed or highlighted by default:

1. Tap the screen to display the on-screen buttons.
2. Go to **Main Menu > Settings > Reading Settings > Viewing Modes**.
3. Toggle the top right button to select the default viewing mode. The **Viewing Modes** screen displays a sample of the current viewing mode while the toggle button displays the next mode in the cycle.



Snapshot mode shows a full screen of text without high contrast color.



Teleprompter mode shows text in paragraph form using high contrast color.



Tickertape mode shows one line of text at a time using high contrast color.

**Note:** Zones are not available in the **Viewing Modes** screen and cannot be selected as the default mode.

4. Tap the bottom right button to toggle the way text is emphasized as it is read aloud:

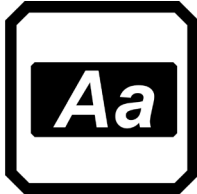

Box highlighting



Underline highlighting

5. Each default is set automatically when you make the selection.
-



In Advanced mode, RUBY 10's file manager enables you to view, store, delete, import, and export files. You can also add or re-record a file's audio tag.

On the **Main Menu**, tap the **File Manager** icon to display the **Files** screen. This screen has two tabs, **Images** and **Document**, which list the files saved on RUBY 10.

Icons represent the file type. RUBY 10 supports the following image files: JPEG, BMP, WebP, and PNG. RUBY 10 supports the following document files: DocX, PDF, RTF, and TXT.

A multi-page file is VCB (Vispero Compressed Book), which can be comprised of images and/or text.

Files are ordered by the capture date, or date modified, and the most recent file is at the top.

The system file name, displayed below the file type, cannot be changed.

## **Opening and Editing a File**

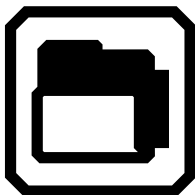

To open or edit a file, tap the screen to display the on-screen buttons, then go to **Main Menu > File Manager**. The **Files** screen displays.

Go to the **Images** tab for files with these extensions: BMP, JPEG, PNG, and WebP.

Go to the **Document** tab for files with these extensions: DocX, PDF, RTF, and TXT. A multi-page file has a VCB (Vispero Compressed Book) extension. Icons represent the file type.

Select the file on the **Files** screen, then tap the **Open** button. See the [Image Files](#) or [Document Files](#) sections that follow to learn how to edit a file.

**Note:** You can select and open only one file at a time.

### ***Image Files***

When you open an image file, tap the screen to display the buttons. Tap a button to make changes to the image.



Flip the image.

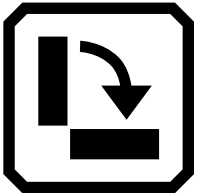

Rotate the image clockwise 90 degrees.

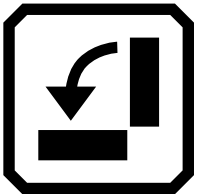

Rotate image counterclockwise 90 degrees.

### ***Document Files***

When you open a document that was captured on RUBY 10, the document is read using the same reading language and voice that was set when you saved the file.

If the language is the same as the default reading language but the voice is different, the default voice is used. If the language is available but the voice is not, the voice closest to the missing one by locale and gender is used.

To change the language and voice saved with the file, tap the **Edit** button next to the language.



If you open a text file that you imported, the current reading language and voice is used. You cannot change it.

### ***File Names***

If you have named the file by adding an audio tag, then you can listen to it by tapping the **Play** button at the top of the page. If you wish to re-record the audio tag, tap the **Record** button. See [Recording Audio Tags](#) for more information.

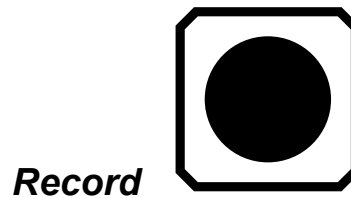

### **Exporting or Importing Files**

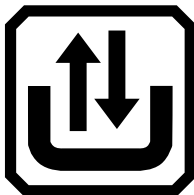

From the **Files** screen, you can export or import files by tapping the **Transfer** button, which displays the **Select Transfer Mode** screen.

Tap the **Export** button to move RUBY 10 files onto a USB-C drive.

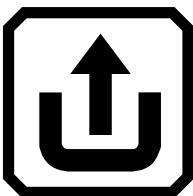



Tap the **Import** button to move files onto RUBY 10 from a USB-C drive.

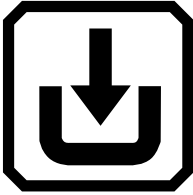

**Note:** You can only import a folder (directory) of files—not a single file or subfolders (subdirectories).

RUBY 10 exports files automatically so you do not need to be familiar with file directory structures. However, you must either export all files at once or one at a time.

## Storing Files

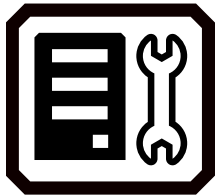

You have approximately 3 GB of space to save files. However, storage lessens when additional languages are used for OCR and speech. Keep an eye on the amount of storage available to avoid running out of space—if this occurs, you must delete some files to make room before you can save new ones.

To help you manage device storage, review the **Device Storage** screen. Tap the screen to display the on-screen buttons, then go to **Main Menu > Settings > System Settings > Storage**.

## Deleting Files

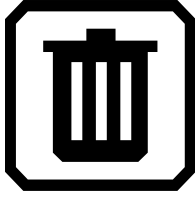

If RUBY 10's memory is full, then an error message will display when you attempt to capture an image. You must delete some files before saving new ones. You can either delete one file at a time or all of them at once.

**Note:** You cannot delete an open file.

If you want to back up the files before you delete them, export them to a USB-C drive. See [Exporting or Importing Files](#) on page 66.

To delete a single file, go to the **Files** screen, select the icon that represents the file, then tap the **Delete** button.

To delete all files:

1. Tap the screen to display the on-screen buttons.
  2. Go to **Main Menu > Settings > System Settings > Storage**.
  3. Tap the **Delete All** button.
-

## Connecting RUBY 10 to Other Devices

RUBY 10 offers an audio jack, a USB-C connection, Miracast, and Bluetooth to connect with a variety of devices, including headphones, a speaker, an HDMI TV or monitor, a computer, or a cell phone.

### Audio Jack Connections

RUBY 10 has an audio jack, where you can plug in headphones or a speaker. The round jack is to the right of the orange Power button.

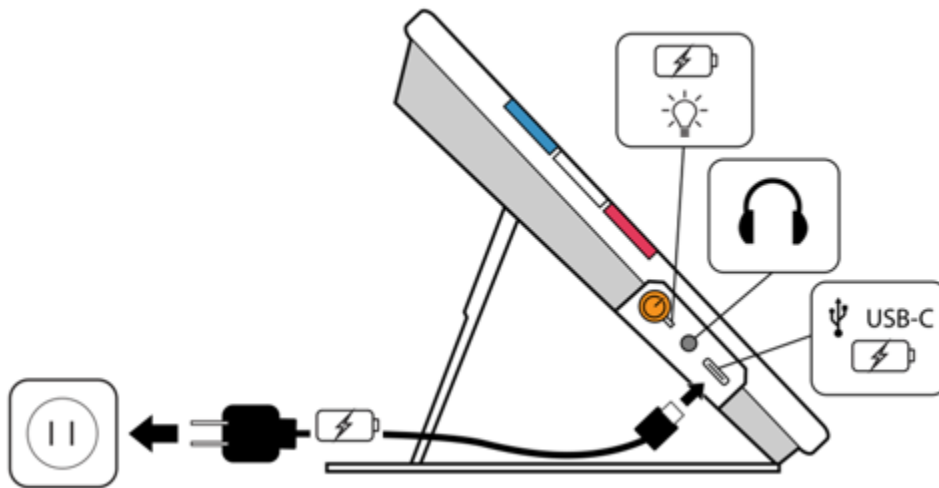

### USB-C Cable Connections

RUBY 10 has a USB C-port, which can be used with the USB-C cable that came in the box to:

- Charge the device.
- Connect the device to a computer to transfer files or perform updates.

You also can connect the device to an HDMI TV to mirror RUBY 10 content using a USB-C to HDMI active cable.

---

## ADVANCED MODE ONLY

---

### Miracast Wireless Connection

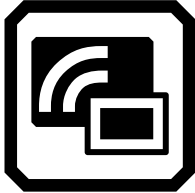

You can use Miracast® to stream RUBY 10 audio and visual content to a computer, television, tablets, or phone. The content simultaneously displays on RUBY 10 and the other device. RUBY 10 supports Wi-Fi Direct from RUBY 10 to a device (not vice versa).

**Note:** Bluetooth is not required to use Miracast.

#### *Connecting to a Miracast-enabled Display*

If you connect to a Miracast-enabled display, RUBY 10 streams its audio and visual content to that display in a mirrored view. You must enable Miracast both on RUBY 10 and the receiving device before you can stream content. To enable Miracast on RUBY 10:

1. Enable Miracast on the device to display the RUBY 10 screen. The device must be ready to connect over Wi-Fi Direct.
2. Tap the RUBY 10 screen to display the on-screen buttons.
3. Go to **Main Menu > Miracast**.

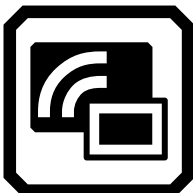

4. On the **Miracast** screen, enable Miracast by tapping the checkmark.



5. RUBY 10 automatically scans for devices and lists them on the **Miracast** screen. Select the name of the device where you will display the RUBY 10 screen, and tap the plus sign.

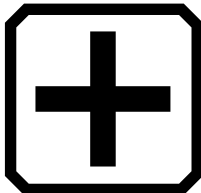

A message indicates whether RUBY 10 successfully connects with the device. Once the connection is made, RUBY 10 streams its content to that display in a mirrored view.

6. When you are done streaming content, return to the **Miracast** screen and tap the **Disable** button.

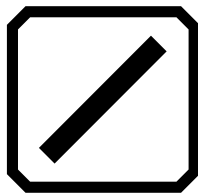

### ***Status of Miracast Connection***

The word in parentheses by the name of each device denotes its status:

- “Connected” means the device is actively connected with RUBY 10.
  - “New” displays beside the name of a device that is not connected.
-

## Bluetooth Wireless Connection

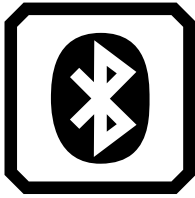

You can use Bluetooth® to connect RUBY 10 with an audio device, such as headphones or a speaker.

### *Using Bluetooth to Connect*

You can only connect with one device at a time. To connect RUBY 10 with an audio device using Bluetooth:

1. Tap the **Bluetooth** button on the Main Menu to display the **Bluetooth** screen. Enable Bluetooth by tapping the checkmark.



2. RUBY 10 automatically scans for wireless devices and lists them on this screen. “New” displays beside the name of each device before it is paired. Enable Bluetooth on the device you want to use for audio.
3. Wirelessly connect RUBY 10 with the device by selecting its name and tapping the plus sign. The plus sign is hidden while RUBY is connecting.

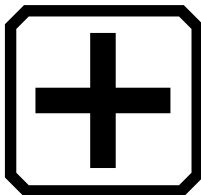

**Note:** Keyboards, mice, and microphones are not supported.

4. When you are done, return to the **Bluetooth** screen and tap the **Disable** button.

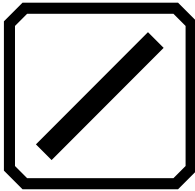

### ***Re-enable Bluetooth***

When you re-enable Bluetooth, RUBY 10 automatically pairs with all previously paired devices. If you no longer wish to pair with a device, select the device name and tap the **Delete** button. RUBY 10 disconnects with the device and loses the memory of the connection. The device name no longer displays.

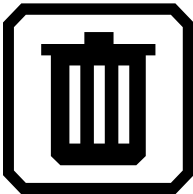

### ***Status of Bluetooth Connection***

The word in parentheses by the name of each device denotes its status:

- “Paired” means RUBY 10 previously connected to the device.
- “Connected” means the device is actively connected with RUBY 10.
- “New” means the device has not been paired.

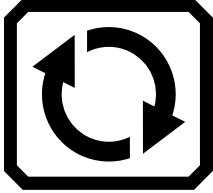

You can update your device by downloading a new release from the Freedom Scientific website and using the **Update** screen to install it either from a USB-C drive or from a computer using the USB cable. Review the requirements below before following the update steps.

**Note:** It is recommended that you use a USB-C drive because it requires much less free space on the device.

### Requirements

Before you update your RUBY 10, ensure that:

- You download the release file, which has a VHU extension, from the Freedom Scientific website. A VHU (Vispero Hardware Update) file updates the RUBY 10 software and firmware.
- You have either the USB cable that came with RUBY 10 or a USB-C flash drive (formatted FAT32). The flash drive is preferred.

**Tip:** A flash drive can also be used to import/export files from RUBY 10 and download log files for technical support. We recommend purchasing a dual flash drive that offers both USB-A and USB-C. Also, a USB-C adapter can be used with a USB-A flash drive.

- Your device has enough free space to update. To determine the available device storage, tap the screen to display on-screen buttons, then go to **Main Menu > Settings > System Settings > Storage**. For a more accurate assessment of the space needed, refer to the documentation accompanying the VHU file on the website. It takes less free space if you use the USB-C flash drive rather than the USB-C cable.



- Your device has 60 percent battery power according to the bars on the battery icon in the top left corner of the screen.

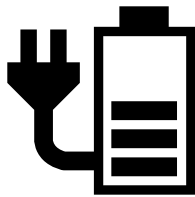

**Note:** The device is fully charged when the LED light by the orange Power button is green. The battery icon indicates the remaining battery life with each segment representing about 20% of total charge capacity.

## Update RUBY 10 Using a USB-C Drive

This method is preferred because it requires much less free space on the device. To update the device using a USB-C flash drive:

1. Go to the Freedom Scientific website and download the latest RUBY 10 release file, which has a VHU extension.
2. Copy the VHU file onto a USB-C flash drive.
3. Insert the USB-C drive with the VHU release file into the RUBY 10 USB port.

**Caution:** Do not remove the drive before you receive the confirmation message and the system fully restarts.

4. On RUBY 10, tap the screen to display the on-screen buttons, then go to **Main Menu > Settings Menu > System Settings > Update Device**.

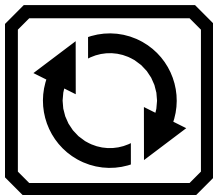

5. Select the file and tap the **Update** button.

**Tip:** If the file does not display, try flipping over the USB-C flash drive and reinserting it into the port.

6. After the update, a confirmation message displays. Tap **OK** and the system automatically restarts.

## Update Using a USB Cable

To update the device using a USB cable:

1. Go to the Freedom Scientific website and download the latest RUBY 10 release file, which has a VHU extension.
2. Insert the USB-A side of the cable into the computer where you downloaded the VHU file.
3. Insert the USB-C side of the cable into the RUBY 10. File Manager automatically detects the RUBY 10 file structure.
4. In Windows File Manager, copy the VHU file from the computer into the **DCIM/Updates** folder on RUBY 10. The **Update Device** screen automatically opens on RUBY 10 when you begin copying, but do not proceed until the file has copied 100%. Check the file transfer progress bar to determine the status of the copy.

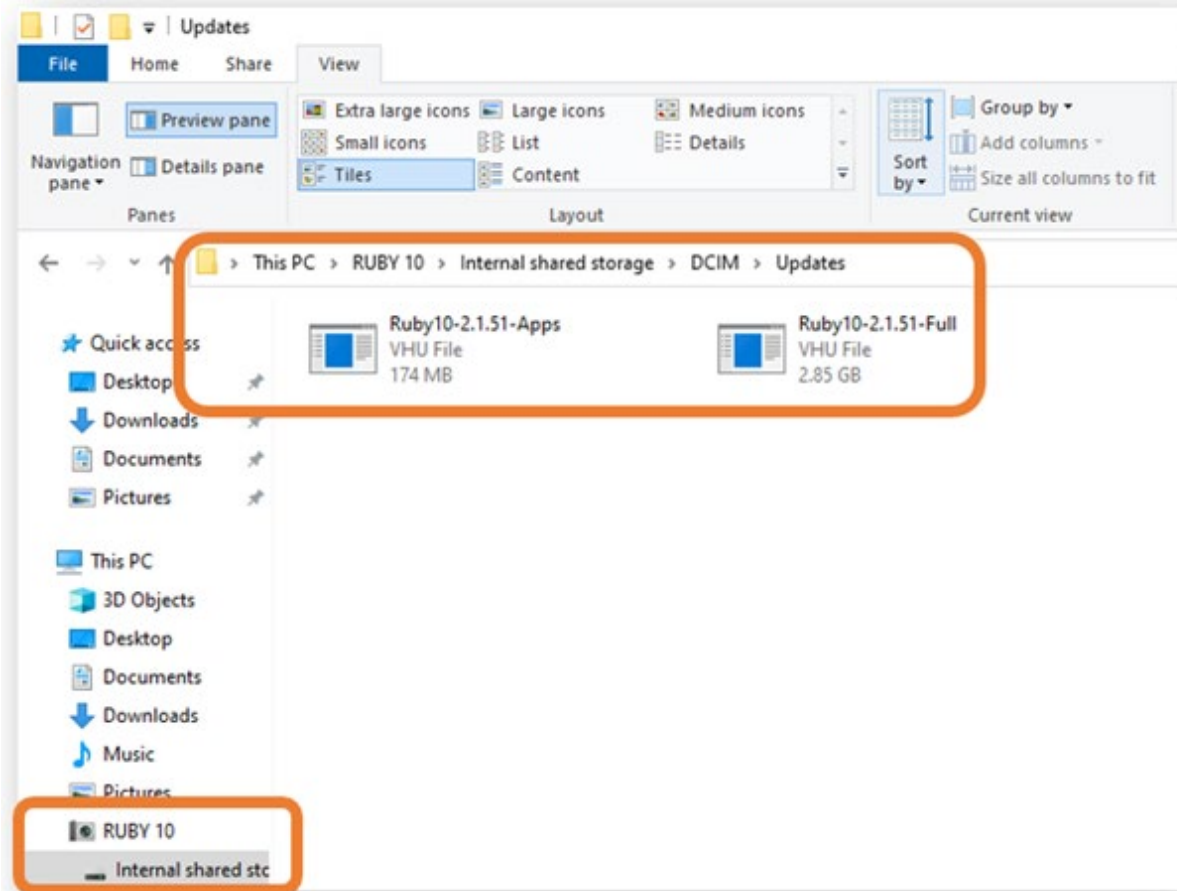

5. Select the file and tap the **Update** button.
6. After a successful update, a confirmation message displays. Tap **OK** and the system automatically restarts. The VHU file used to update the device is automatically deleted from the RUBY 10.

**Note:** Rarely, an **Invalid Configuration** screen with an **Update** button displays. If this happens, copy the VHU file onto a USB-C flash drive, insert it into the RUBY 10 USB port, and tap the **Update** button on the **Invalid Configuration** screen.

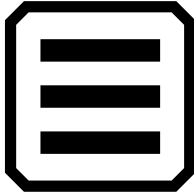

You access the menus by tapping the **Main Menu** button, which is available in Live view by tapping the screen. The icons on the **Main Menu** depend on whether you are in Default or Advanced mode. This section describes the Advanced mode because Default mode is a subset of it. For information on the differences between the two modes, go to [Default Mode and Advanced Mode](#).

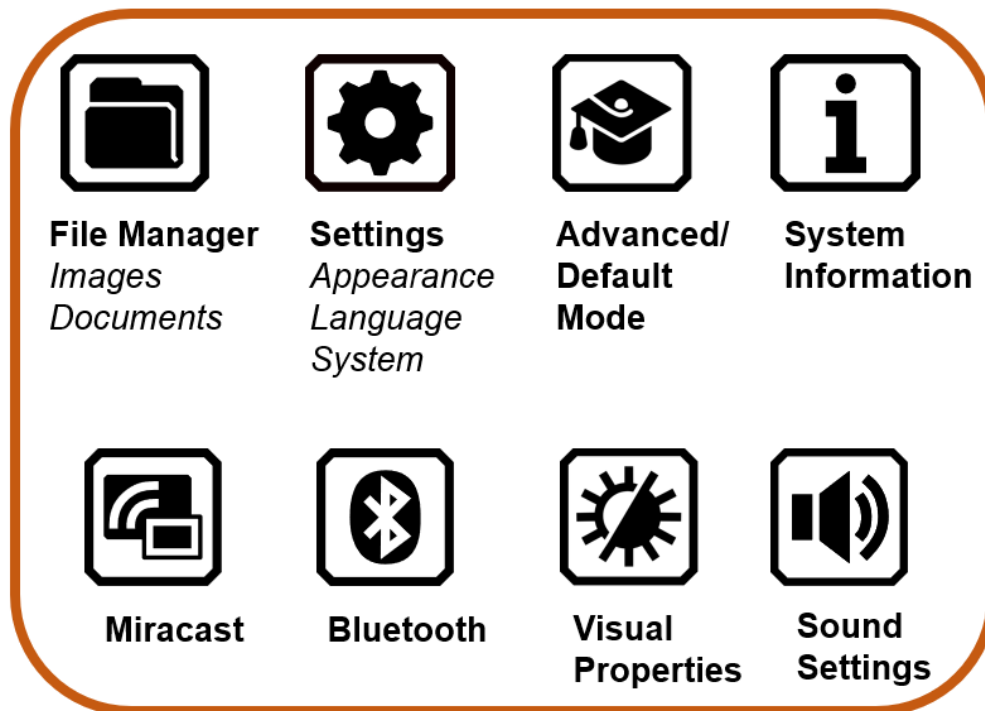

The **Main Menu** offers ways to use your device and change its settings, such as its appearance and languages. Tapping on an icon on the **Main Menu** displays another menu or a screen for performing tasks.

This chapter outlines the contents of the menus and the screens used to modify the behavior of RUBY 10. The Main Menu has icons that you tap to display other menus and screens.

You can continue tapping the **Back** button to move through previous menus, or you can press the green Live View button to get out of the menus entirely.

## File Manager



Displays the **Files** screen, which has an **Images** tab and a **Document** tab. You can import and export files from this screen, as well as open files and assign audio tags.

## Settings Menu

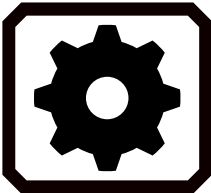

Opens the **Settings Menu**, which has three icons used to display the **Appearance Menu**, the **Language Menu**, and **System Settings**.

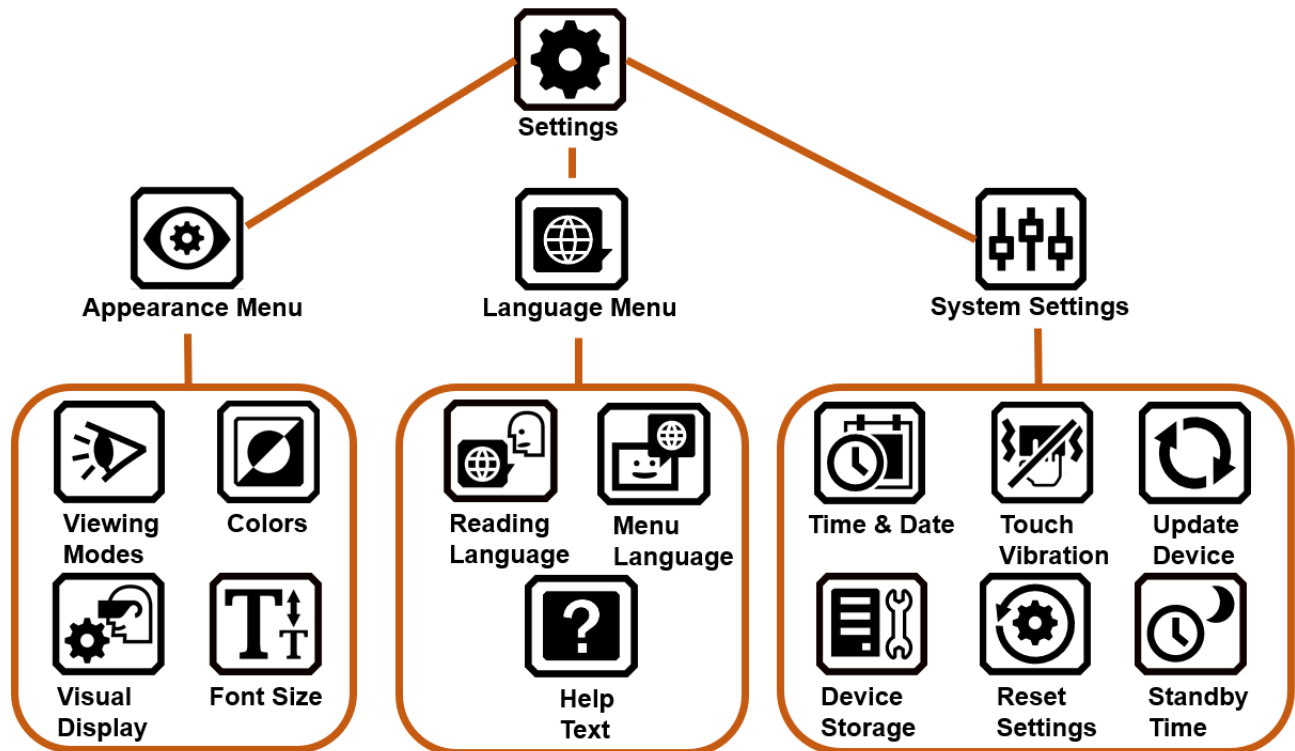

## *Appearance Menu*

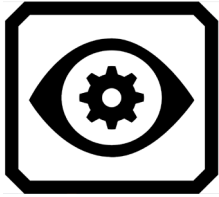

Takes you to screens where you set the viewing modes, color combinations, visual displays settings, and default font size.

### *Viewing Modes Screen*

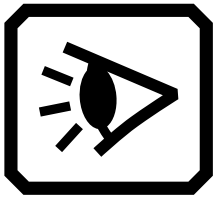

Provides buttons for setting the way documents display on the screen by default. You can select full image, teleprompter, or tickertape. For highlighting, you can select underline or box. See page [Viewing Modes Screen](#).

### *Color Combinations*

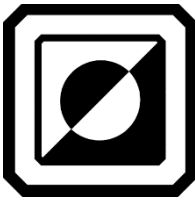

Has two tabs where you select the color combinations included in the rotation when you press the **blue** Color Mode button. One tab controls text colors, while the other controls image colors.

### *Visual Display Settings*



Enables you to set filters for light sensitivity and color blindness.

### *Default Font Size*

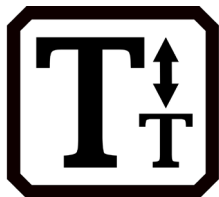

Allows you to set the default size of text used in the menus, screens, and help text of the RUBY 10 user interface. You can select 24 point through 72 point.

## *Language Menu*



Displays screens for setting the menu language and the reading language. Also takes you to a screen for determining whether the help text is available and narrated.

## *Reading Language*



Displays the **Reading Language** screen. Using the Language tab, select the language used to perform text recognition when you scan a document. Tap the **Voice** tab to select the voice used to narrate the recognized text in document files.

## *Menu Language*



Displays the **Select Menu Language** screen. Using the **Language** tab, select the language used to display the menus, screens, messages, and help text. Optionally, tap the **Voice** tab to select the voice used to narrate the user interface while you move around the system.

## *Help Text*



Displays the **Help Text** screen, which enables you to view and/or listen to text describing the hardware button or software control after you press and hold it for three seconds.

## System Settings

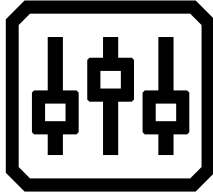

Displays the **System Settings** menu, which takes you to screens for determining characteristics of the device: time and date, touch vibration, updating the device, and device storage.

### *Time & Date*

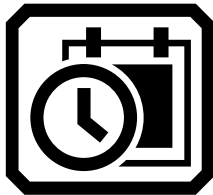

Displays the **Time & Date** screen, where you tap each **Pencil** icon to display the **Select Date** screen or **Select Time** screen. Swipe up or down in each column and tap to set the date and time. You can also choose to use a 24-hour clock. The time is displayed in the upper-right corner of menus, and files are time stamped with the time and date when you saved them.

### *Touch Vibration*



Enables or disables touch vibration (also called haptic feedback) when you press a button or tap a software control.

### *Update Device*

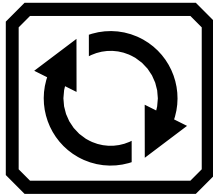

Displays the **Update Device** screen, where you can install a new release of software and firmware. See [Updating RUBY 10](#).

### *Device Storage*

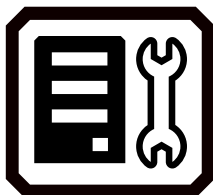

Displays the **Device Storage** screen, which shows the available gigabytes of storage remaining on RUBY 10. See page [Storing Files](#).



### *Reset Settings*

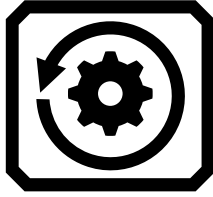

Displays the **Reset Settings** screen. Tapping **Yes** on this screen returns the device settings to the original factory default values. You will have to set the menu language and voice, font size, and time and date just as you did the first time you used RUBY 10. See page 2 for instructions.

### *Standby Time*

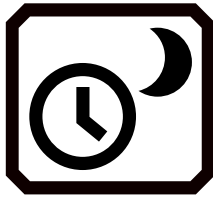

Displays the **Standby Time** screen, which is used to set the number of minutes the device is unused before automatically entering standby mode. Values are **None** to **30 minutes**. Select the value and tap **Previous** to immediately enable the new value.

### **Default Mode / Advanced Mode**



Moves from Default mode to Advanced mode or from Advanced mode to Default mode.

### **About**

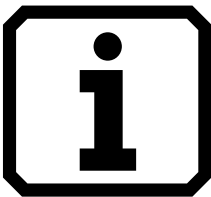

Displays the **About** screen, which provides technical facts about the device and support contact information. The **Delete** button on this screen enables you to clear support data. The **Export** button is used to export support data to a USB-C drive or to another computer using the USB-C cable.

### **Miracast**

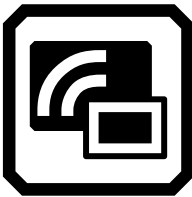

Displays the **Miracast** screen, where you can connect RUBY 10 to another display device, such as a television, over a wireless connection.

## Bluetooth

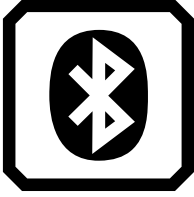

Displays the **Bluetooth** screen, where you can connect RUBY 10 to another device via a Bluetooth wireless connection.

## Visual Properties

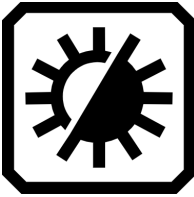

Displays the **Visual Properties** screen, where you can globally adjust the contrast to improve how images display. You can also adjust how much edges are smoothed and/or highlighted, as well as the brightness of the screen. See [Visual Properties](#) for more information.

## Sound Settings



Displays the **Sound Settings** screen, where you globally control the volume. Slide the left control up for louder or down for softer.

---

**RUBY 10 Speech only:** Control the rate of speech by sliding the right control up for faster or down for slower.

---