

Instruction manual

(original instruction manual)

Assembly and operation

DESCEND (Ultra-Low Bed)

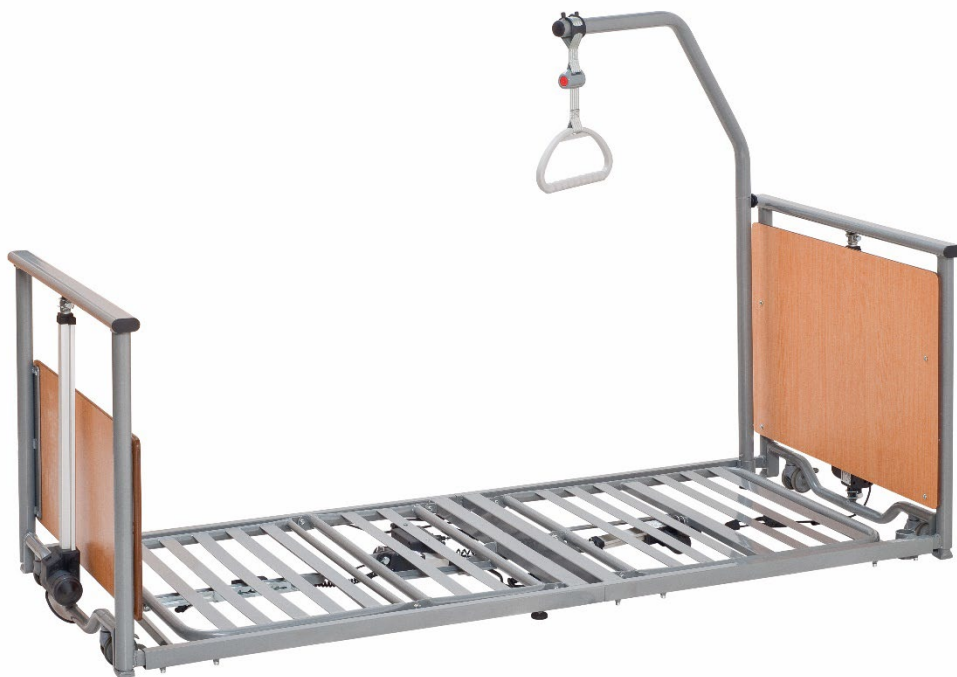

Index

Foreword	4
1 General information	5
1.1 Explanation of the symbols used	5
1.2 Explanation of the designated groups of persons.....	6
2 Intended purpose	8
2.1 Intended use (application environment)	8
2.2 Unauthorized use.....	8
3 Safety instructions	9
3.1 General safety instructions	9
3.2 Safety instructions for the operator	9
3.3 Safety instructions for the user	10
3.4 Cleaning and disinfection.....	10
3.5 Maintenance and repair.....	10
3.6 Accessories / Options.....	11
3.7 Storage.....	11
3.8 Useful life and disposal.....	11
4 Storage and transport	12
5 Assembly and commissioning	12
5.1 Removal from the transport device.....	12
5.2 Control of the delivery and the scope of delivery	14
5.3 Assembling the Descend.....	14
5.4 Erector with triangle handle (accessory)	18
5.5 Foldable side rails (accessories- item number BC 1.19.0270000).....	19
<i>5.5.1 Safety instructions when using the steel side rails</i>	19
<i>5.5.2 Assembly of the steel-side rails</i>	20
5.6 Commissioning	21
5.7 Disassembling the Descend care bed	21
6 Functional description	22
6.1 Technical overview of the Descend	22
6.2 Hand control with locking function	23
6.3 Locking function for handset.....	23
6.4 Operation of the lockable track rollers	24
6.5 Emergency lowering	24
<i>6.5.1 Emergency lowering via integrated 9V battery (electric)</i>	24
<i>6.5.2 Battery change</i>	24
<i>6.5.3 Emergency lowering of the backrest (manual)</i>	25
6.6 Trendelenburg / Reverse Trendelenburg function (option)	26
7 Care, cleaning and disinfection	27
8 Cause and remedy of malfunctions	28
9 Maintenance	28
9.1 Fundamentals	28
9.2 Maintenance plan	29
9.3 Check of first-error safety by means of locking function in manual switch.....	31
10 Warranty	31
11 Useful life and disposal	31
12 Technical specifications	32

12.1	Technical data (mechanical)	32
12.2	Technical data (electrical).....	32
12.3	Technical data environment.....	33
12.4	Classification	33
12.5	Identification plates	33
12.6	Information on electromagnetic compatibility	35
13	Declaration of conformity	39

**Please read and observe these operating instructions before each use!
If you change ownership, please include this instruction manual!**

Foreword

Dear customer,

The Prius Healthcare team would like to thank you for the trust you have placed in our Descend care bed. With the decision to purchase a care bed from "Prius Healthcare" you receive a care product with high functionality at the highest safety level.

With the purchased care bed, we can guarantee you optimal lying comfort.

All beds are carefully checked by our staff before delivery.

The healthcare bed delivered to you has left our premises in perfect condition.

When you receive the healthcare bed, the responsibility for its proper and intended operation also passes to you at the same time.

These instructions for use inform you as the operator and your users about the function and safe handling of the Descend healthcare bed in their daily work.

Please always keep the instructions for use at hand near the healthcare bed.

We are convinced that our product will make a positive contribution to your care.

Yours sincerely

The Prius Healthcare Team

1 General information

Before the first use:



Read the instruction manual conscientiously and completely!



Please pay attention to the various safety instructions. The Descend nursing bed should be cleaned and disinfected before using it for the first time and before each use.

Prius Healthcare care beds carry the CE mark and meet the requirements for safety and functionality. The Descend healthcare bed has been tested according to international standards, which include the safety requirements for medical products.

However, these safety requirements can only be met if the user is satisfied that the patient bed (including accessories) is in proper condition before use.

Please note the Medical Device Operator Ordinance (MPBetreibV, 2021).

1.1 Explanation of the symbols used

In these instruction manual, important information is indicated by the following symbols:



Read information with this symbol carefully and observe it urgently. This information is relevant to safety.



This symbol warns of dangerous voltage. There is a danger to life!



This symbol warns of general dangers. There is danger to life and health



Mark of conformity according to Medical Devices Regulation (EU) 2017/745



Manufacturing date



Manufacturer of the medical device



Medical device



Serial number

IPX4

Protection of electrical equipment against splashing water



Symbol for device of protection class II, double protective insulation



Symbol for type B application part according to IEC 60601-1

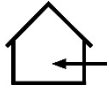

The nursing bed may only be used indoors



The product must be sent to a separate waste collection system in the European Union. Disposal with normal household waste is not permitted.



Symbol for direct current (DC)



Symbol for alternating current (AC)



Symbol for safe working load



Symbol for maximum patient weight



Symbol for reading the instruction manual

1.2 Explanation of the designated groups of persons

Operator

The operator of a medical device is any natural or legal person who is responsible for the operation of the health facility in which the medical device is operated or used by its employees. Contrary to sentence 1, the operator of a medical device which is owned by a member of the medical profession or the medical profession and which is brought into a health facility for use by this member shall be the relevant member of the medical profession or the medical profession. A person is also considered to be an operator if he keeps medical devices ready for use outside of health facilities in his company or facility or in public space. [§2, paragraph 2, MPBetreibV, 2021]

Requirements to be met by the operator

- Please note that for you as the operator of this medical device, the requirements of the Medical Device Operator Ordinance (MPBetreibV, 2021) are binding.
- The Descend nursing bed is a medical device and may only be operated and used in accordance with its intended purpose and the regulations of the MPBetreibV, the relevant legal regulations as well as the generally recognised rules of technology.
- Only instruct persons to use this medical device who have the necessary training or knowledge and experience and who have been instructed in the medical device to be used.
- Instruct the user in the proper handling of this medical device and document the instruction in an appropriate form.
- A combination with other medical devices (including accessories) or with other objects may only be operated and used if they are suitable for use in this combination, considering the intended purpose and the safety of patients, users, employees or third parties.

User

The user is anyone who uses a medical device on a patient within the scope of the Medical Device Operator Ordinance (MPBetreibV). [§2, Para. 3, MPBetreibV, 2021]

User requirements

- Use the Descend nursing bed only as intended and in accordance with these instructions for use.
- Only use this product if you have been properly instructed in its use and have the necessary training or knowledge and experience.
(e.g. nursing staff).
- Before using the Descend nursing bed, make sure that it is in good working order and condition.
- Observe the instructions for use and the other safety-related information enclosed.
- If suspected serious events occur in connection with the Descend care bed, they must be reported to Prius Healthcare and the responsible federal authority. Serious incidents occurring in other contracting states of the Agreement on the European Economic Area must be reported to the competent authorities of this state.
- Suspected Serious events means an event that cannot be ruled out due to an undesirable side effect of a product, a malfunction, deterioration in the properties or performance of a product, including application errors due to ergonomic features or an inadequacy of the information provided by the manufacturer is based.
Such a suspected serious event can have led directly or indirectly to death, to a temporary or permanent serious deterioration in the state of health of a patient, user or other person, as well as to a serious risk to public health (refer to the Ordinance on the Reporting of Suspected serious incidents with medical devices as well as for the exchange of information between the responsible authorities -MPAMIV)

Patient / Resident

In these instructions for use, a patient is defined as a person who needs nursing care due to his or her illness, disability or age and is lying in a nursing bed.

Patient / Resident

In these instructions for use, a patient is defined as a person who needs nursing care due to his or her illness, disability or age and is lying in a healthcare bed.

requirements for the patient / resident

It is possible for the patient lying in bed to independently operate the electrical adjustment functions of the care bed via the hand switch if he has been instructed in the use of the care bed and is mentally and physically able to do so.

Independent use of the care bed by the patient therefore requires that the patient can carry out the adjustment functions safely and specifically using the hand control and can also free himself from dangerous situations.

Qualified personnel

The operator's employees who are authorised to deliver, assemble, dismantle and transport the healthcare bed based on their training or instruction are referred to as qualified personnel. In addition, these persons are instructed in the instructions for cleaning and disinfecting the healthcare bed.

2 Intended purpose

2.1 Intended use (application environment)

The Descend nursing bed is designed for the accommodation of adults with a height from 150 cm and a body weight from 40 kg to max. 170 kg. It is suitable for use in retirement homes, nursing homes and in home care - i.e. in 3 and 4 - and may only be operated under the operating conditions described in these operating instructions.

The Descend nursing bed is designed to alleviate or compensate for a disability or incapacity and to facilitate working conditions for the caregiver.

The Descend is a low bed, i.e. the bed frame can be lowered close to the floor. It can therefore be used specifically to prevent falls.

Any other use is considered improper and is excluded from possible liability.

Attention: The Descend nursing beds are not designed for use in hospitals.

They are not EX-protected and must not be operated in hazardous areas.

The Descend may only be used in dry interior rooms.

They are only suitable for transporting patients within the patient's room and with the lying surface adjusted to the lowest horizontal position.

The Descend nursing bed has no connection option for equipotential bonding.

You must therefore take this into account when combining the care bed with other electrical medical devices or with other mains-operated products.

The operator, as a competent person, must check whether the corresponding combination of the care bed with other electrical devices is safe during the service life and no unacceptable risks can occur.

The operator of the medical devices is responsible for ensuring that the combination of the devices meets the requirements of IEC 60601-1.

Non-electrical medical devices must comply with the IEC or ISO safety standards applicable to these devices if they are to be used / combined with the care bed.

If cables from other devices are routed in the care bed, precautions must be taken to prevent these cables from being crushed between parts of the care bed.

Take into account the information and safety instructions in the instructions for use of the electrical devices that you want to combine with the Descend nursing beds (e.g. anti-decubitus alternating pressure systems, feeding systems, infusion pumps, lamps, etc.) as well as the requirements of the IEC 60601-1 standard (in the current Version).

In this case, **all bed functions** must be **deactivated** for safety reasons for the duration of use via the **integrated locking device** on the hand control.

2.2 Unauthorized use

All uses deviating from the intended use, which can then also lead to hazards.

These include, for example:

- Load on the nursing bed exceeds the permissible safe working load (see par. 12.5 and nameplate on bed frame)
- Operation of the nursing bed by the patient or resident who has not received any instruction
- Use of the nursing bed for children and adults with atypical anatomy
- Try to move the nursing bed in the braked position
- Use of the nursing bed on a non-horizontal surface (max. inclination 5°)

3 Safety instructions

3.1 General safety instructions

 Possible potential dangers which may occur despite proper operation must be pointed out separately during the instruction. Before initial operation, the user/care personnel must read the operating instructions carefully and in detail.

 No objects or body parts of persons may be in the movement area of the bed while the adjustment functions are being actuated. Risk of crushing!

 Ensure that the nursing bed cannot be operated by children playing and that there are no pets under the bed when the bed is adjusted.

 If the psychological or mental condition of the patient requires it, the hand control must be locked via the lock switch on the back of the hand control (nurse key). The locking function is described in detail in par. 6.3. For this patient group it may also be necessary to place the hand control outside the patient's access area in order to avoid the risk of strangulation by the cable.

 Bed adjustments may only be carried out by instructed persons or in the presence of an instructed person.

The mains plug should always be accessible so that in an emergency the device can be disconnected from the mains supply by pulling it out of the socket.

 **The mains cable must be exposed and must not be jammed, as it is carried along when the bed is adjusted in height. Otherwise the mains cable can be torn out of its strain relief and damaged. In addition, the mains plug can be torn out of the socket and expose electrical cores.**

Cables from other devices used in the Descend healthcare bed must not be pinched, squeezed or pulled by the functions of the healthcare bed. Take appropriate precautions.

 **If the mains supply cable or the mains plug is damaged, the complete supply cable with plug must be replaced. The work may only be carried out by the manufacturer or authorized specialists.**

 **Do not use multiple sockets to connect the mains plug, as liquids can penetrate here. (Fire hazard and electrical shock)**

Before cleaning and disinfecting the care bed, the mains plug must be disconnected from the mains and securely hung up. The plugs for the handset and the motors which are plugged into the control unit on the lying surface drive must be plugged in. This is necessary so that no water can penetrate the control unit.

The maximum duty cycle and safe working load must not be exceeded, otherwise safe operation is no longer guaranteed (see technical data).

 **The Descend care bed must not be used in potentially explosive areas.**

The care bed may only be dismantled if there is no patient or occupant in it.

3.2 Safety instructions for the operator

 Use these operating instructions to instruct each user on safe operation before initial use.

Inform the user of any hazards that may exist if the device is not handled properly.

Only instructed persons may operate the care bed. This also applies to persons who only operate the healthcare bed as representatives.

According to the Medical Devices Regulation (EU) 2017/745, care beds are Class I active medical devices.

This results in obligations for you in accordance with the Medical Device Operator Ordinance (MPBetreibV) in order to ensure the permanently safe operation of this medical device without endangering patients, users and third parties. For long-term use of the systems, function checks and visible damage must be carried out and documented at least once a year (see chapter 9.2).

3.3 Safety instructions for the user

Let the operator instruct you in the safe operation of the care bed.

Observe the general safety instructions as described in para. 3.1.

Bed adjustments may only be carried out by instructed persons or in the presence of an instructed person.

Move the lying surface to the lowest position if you leave the nursing bed unattended with the patient. This will reduce the patient's risk of injury from falling.

If a malfunction or damage is suspected, immediately unplug the power plug from the socket. Mark the healthcare bed as a "defect" and take it out of operation. After that, please inform the responsible operator immediately.

3.4 Cleaning and disinfection



Lebensgefahr

Before cleaning and disinfection, the mains plug must be disconnected from the mains and securely hung up. The plug for the handset and the motors, which are plugged into the control at the lying surface drive, must be plugged in. This is necessary so that no water can penetrate the control unit.

Do not immerse the electrical components in water, but only wipe them off with a damp cloth.



The electrical components must not be sprayed with a high-pressure cleaner or water jet. Only wipe disinfection is permitted.

To avoid skin irritation, always wear liquid-impermeable gloves during cleaning and disinfection work.



Gefahr

Attention: When spray disinfecting with alcohol-containing agents, there is a risk of explosion and fire when used over large areas.

3.5 Maintenance and repair



Maintenance measures (inspection and maintenance) and maintenance (repair) may only be carried out by persons who have at least read the safety regulations, followed these operating instructions and are qualified in accordance with MPBetreibV (2021) §5.



Maintenance, inspection and repair work are not allowed to be carried out on the nursing bed when it is in use and the patient is in it.



In order to detect possible defects in time and to ensure safe use, a technical check (visual and functional check) must be carried out by qualified personnel at least once a year according to the maintenance schedule (see chapter 9.2) after a longer period of inactivity and before each reuse.



If defects, damages or defects are found during the tests, the healthcare bed may no longer be operated. Maintenance of the healthcare bed must be carried out by qualified personnel in accordance with MPBetreibV (2021) §5.



Only original spare parts and accessories of the manufacturer may be used, otherwise any warranty and product liability are excluded.



The 9V block battery is the energy storage device for electrical emergency lowering in the event of a power failure. The energy storage is enough for max. one emergency lowering and must then be replaced. If the expiry date of the battery has expired, it must also be replaced immediately. As batteries are self-discharging, it is recommended to replace the battery every two years when not in

use. Make sure that the battery is an alkaline manganese battery of type 6LR61 and that only this type may be used. Empty batteries must be disposed of in an environmentally friendly manner.

3.6 Accessories / Options



An erector with triangle handle is available as an accessory (see chapter 6.4), the safe working load of which must not exceed 80 kg. The erector is not intended for lifting persons but facilitates the change from lying to sitting position or for changing the position. The trapeze bar must not be swivelled outside the bed and must only be used within its permissible adjustment range, which is defined by the tube holder on the bed. Otherwise the bed may tip over completely and lead to serious injuries.



A foldable side rail is available as a further accessory. When using the optional side rails, observe the assembly instructions in Chapter 5.5 and the safety instructions in chapter 5.5.1.



Please only use mattresses that are compatible with the optional side rails supplied. The distance between the mattress surface in the non-compressed state and the upper edge of the upper side rail must be at least 22 cm. If the distance is less than this, a side guard must be used. As a rule, a mattress thickness of 12 cm is suitable.



Make sure that the dimensions of the mattress match the dimensions of the lying surface of your care bed. When using mattresses that are not compatible with this care bed, hazards can arise, e.g. through falling out, trapping, etc.

Further options are:

- Trendelenburg / Antitrendelenburg function (see chapter 6.6)
- Mattress extension 200mm
- Reading lamp
- Floor lighting

3.7 Storage

If the nursing bed is to be stored for a longer period, the 9V block battery should be removed as a precaution to prevent damage to the bed from any leaking liquid.

3.8 Useful life and disposal

With correct operation and appropriate use, this care bed has an expected service life of 7 to 10 years.

The nursing bed must not be disposed of with normal household waste at the end of its service life. For environmentally friendly disposal, please contact your local authority or Prius Healthcare.



The electrical components (power supply units, control units, drives and hand controls) of these beds are to be treated like electronic waste in accordance with WEEE Directive 2012/19/EU (Waste Electrical and Electronic Equipment) and disposed of properly.

The components used conform to the directive 2011/65/EU (RoHS II) on the restriction of the use of certain hazardous substances in electrical and electronic equipment.



When disposing of it, please note that the bed or its accessories can be contaminated and contaminated with germs. Damage can also result in sharp edges, splintering, etc. These can lead to health risks.

4 Storage and transport

Due to the modular design of the care bed, transport can be carried out effortlessly. This is made possible by a transport device. The care bed integrated in the transport frame can be manoeuvred in the narrowest space by means of the bed rollers.



5 Assembly and commissioning

5.1 Removal from the transport device

On receipt of the delivery and before assembly, check whether the packaging is damaged. Complain any visible damage immediately to the delivering company.

1. Cut the packaging tapes with a side cutter or scissors.
2. Lift the transport carton from the entire bed unit including the transport device.



Please do not dispose of the cover! This can be reused as dust protection when the care bed is later stored in the transport frame.

3. For removal from the transport device, the Descend must be stationary, i.e. the four individual brakes on the wheels must be stationary.
4. First lift the lying surface half for the foot end **(a)** and then the lying surface half for the head end **(b)** out of the transport device.



(a) Lying surface half for the foot end



(b) Lying surface half for the head end

5. Remove both bedsteads from the transport device. Loosen the 4 Allen screws on the connecting straps and unhook them.
6. The Allen screws are needed again for the assembly of the lying surface with the bed control parts!

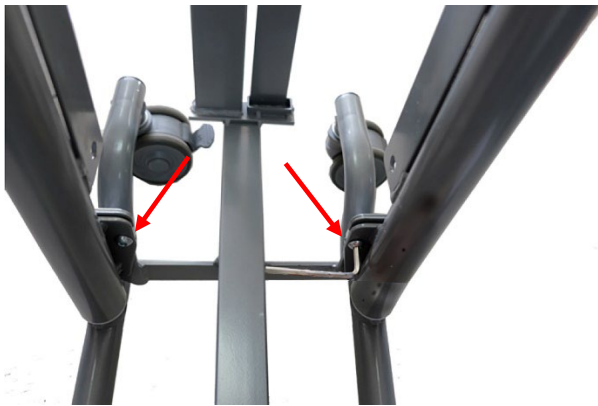

5.2 Control of the delivery and the scope of delivery

After unpacking and removal from the transport device, please check that the delivery is complete. The following parts are included in the scope of delivery:

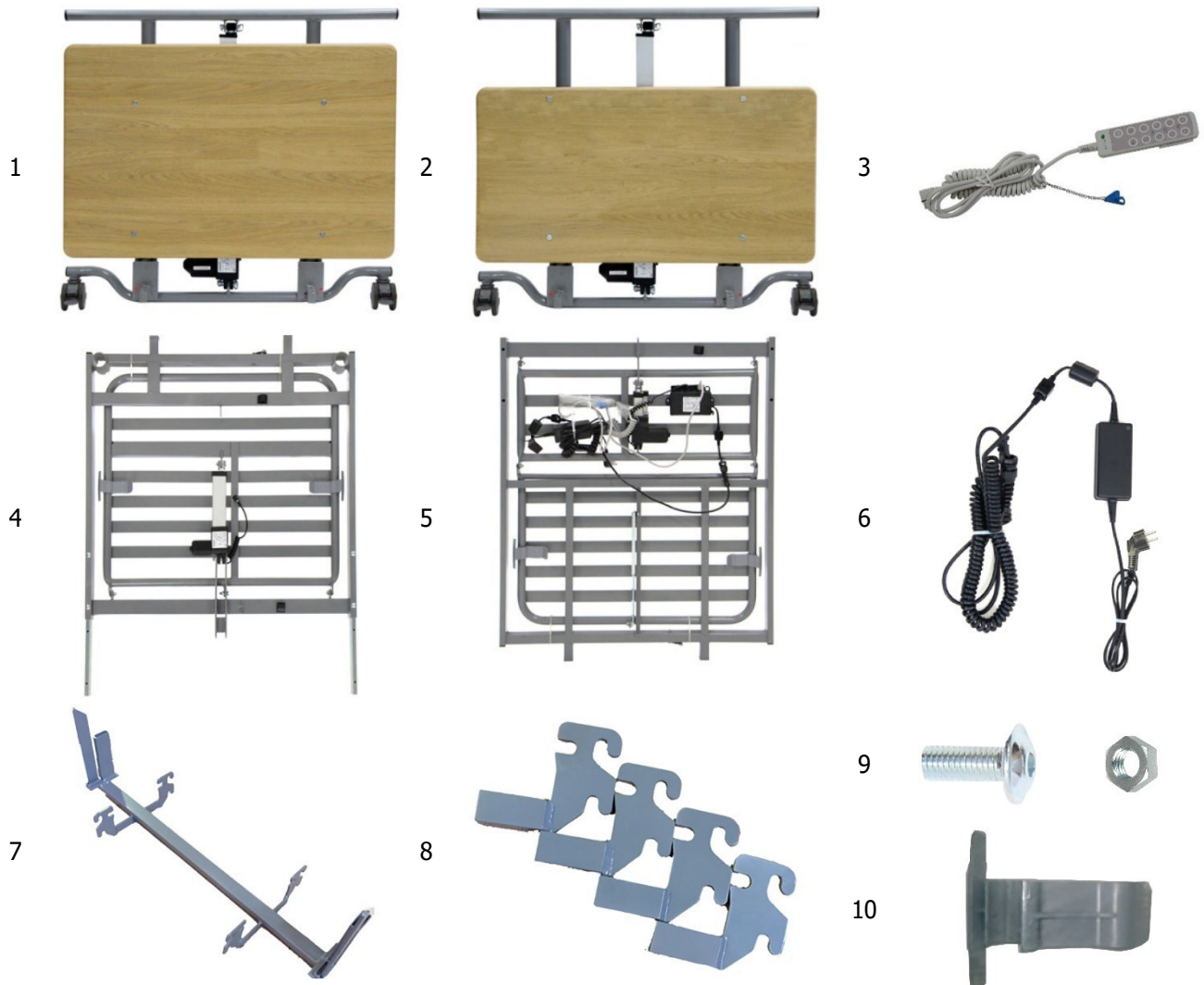

- | | | | |
|-----------|--|-----------|--------------------------------------|
| 1 | Bed control unit head side 1x | 6 | Power supply unit with mains plug 1x |
| 2 | Bed control unit foot side 1x | 7 | Transport device 1x |
| 3 | Hand control with nurse key 1x | 8 | Connecting pieces 4x |
| 4 | Lying surface half head side 1x | 9 | Allen screw 12x and nuts 4x |
| 5 | Lying surface half foot side 1x | 10 | Mattress holder 4x |
| 11 | Instruction manual 1x (without illustration) | | |

5.3 Assembling the Descend

Proceed as follows to assemble the Descend:

- Place the two halves of the lying surface (head and foot side) on the floor with the upper side facing downwards.
- Push the two lying surface connectors already mounted on the lying surface half of the head side into the frame openings of the lying surface half of the foot side.

3. When both lying surface halves are completely pushed into each other, screw the Allen screws into the 4 holes on the frame of the lying surface half of the foot side.
Check that the 4 Allen screws are tight on the lying surface half of the head side.

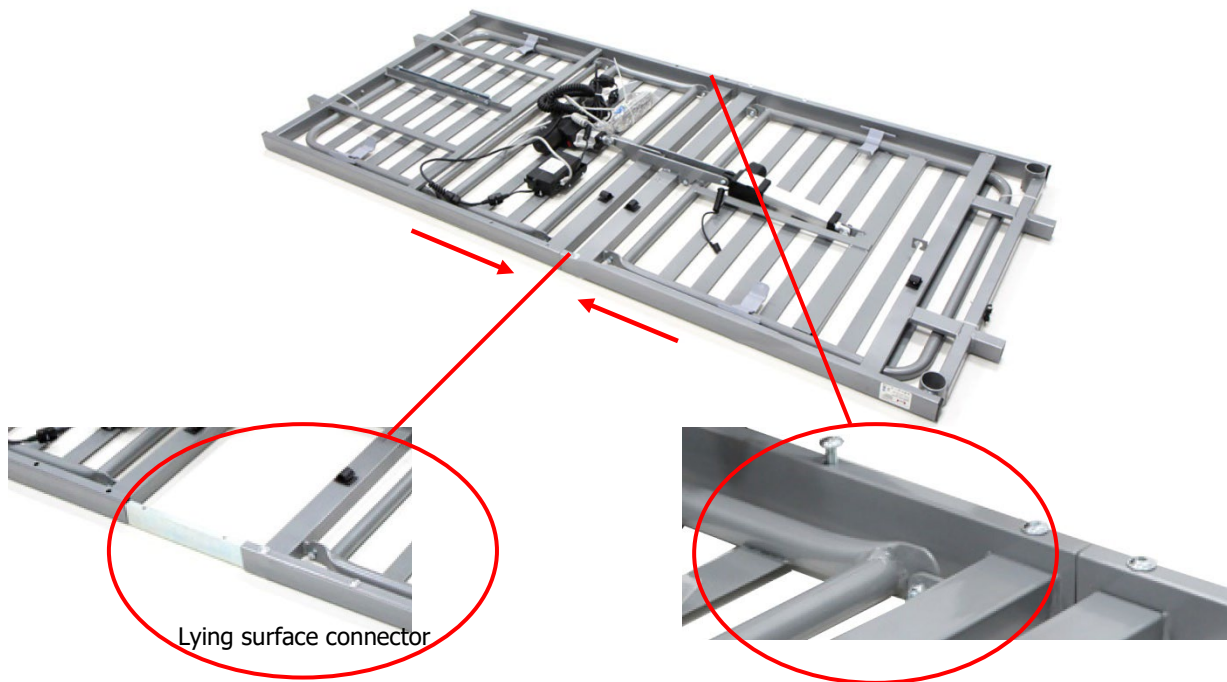

4. Disconnect the cable ties that attach the power supply unit and the hand control to the lying surface.



The electrical cables must not be damaged when the cable ties are cut.

5. Remove the cover from the control unit by loosening both screws.



6. Connect the two plugs of the height adjustment drives of the bed control parts (marked yellow) and the plug of the backrest adjustment drive (marked white) to the control unit.
7. The plug for the thigh adjustment drive (marked blue) and the plug for the hand switch are already plugged into the control unit at the factory.



- 1 Height adjustment drive
- 2 Height adjustment drive
- 3 Thigh adjustment drive
- 4 Backrest adjustment drive
- 5 Hand control

8. Replace the cover plate on the control unit by screwing in both screws.
9. Fix the cable of the hand control and the mains cable to the underside of the lying surface using the tabs provided.
10. Fasten the strain relief of the mains cable in the holder at the head end.



11. Carefully turn the lying surface over so that the drives point downwards to the floor. Do not damage the control unit or the drives.
12. Use a side cutter or knife to remove the cable ties that fix the lying surface to the frame.
13. Insert the connecting straps into the front frame openings and fasten each with two Allen screws.

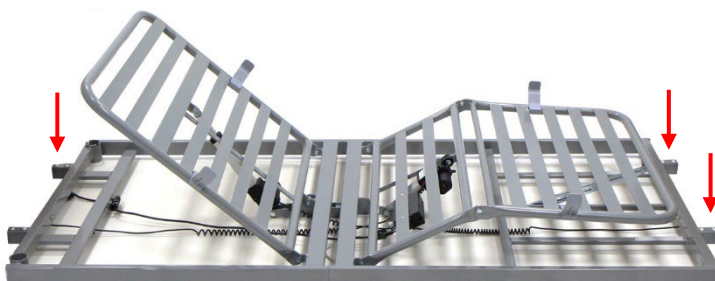

14. Connect the lying surface to the bed control parts. To do this, hook the previously assembled connecting straps into the locating pins on the bed control elements. Then fasten the connections with one Allen screw and one nut each.

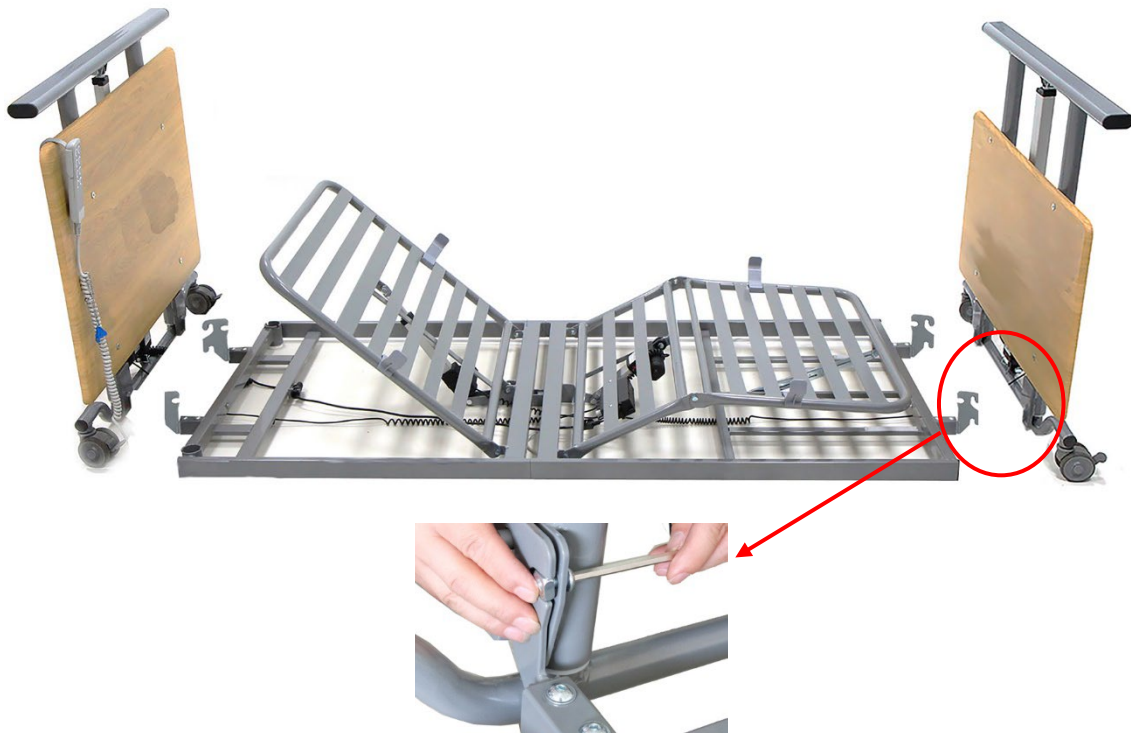

Be sure to mount the bed control for the head side to the lying surface end of the backrest and the bed control for the foot side to the lying surface end of the thigh rest.

15. At the front side of the lying surface frame there is a cable guide at the head and foot side to hold and protect the cables of the height adjustment drives.

To be able to guide the cables through the cable guide, you must loosen the reel on the cable guide with two ring spanners (7mm), insert the cable of the height adjustment drive and fasten the reel again.



16. Position the Descend care bed in the desired position in the room and plug the mains plug into the socket.



The mains plug must always be accessible so that in an emergency the system can be disconnected from the mains supply by pulling it out of the socket.

Make sure that the power cord is positioned so that it cannot be crushed or damaged by driving over it.

5.4 Erector with triangle handle (accessory)

With the help of the erector, the patient can stand up and move more easily into another position. A triangle handle is attached to the erector.

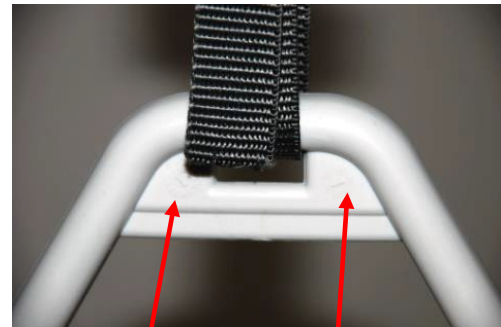
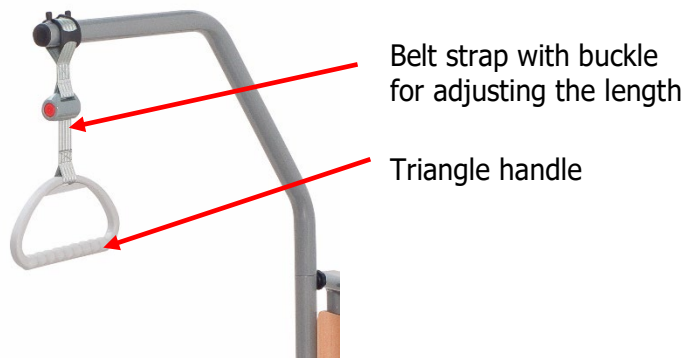

Production month Production year

Mount the erecting bracket and insert it into the erecting fixture in the lying surface. Make sure that the locking cylinder pin engages in the recess of the erecting fixture.



Attention: The erecting bracket must not be used outside the latching mechanism.

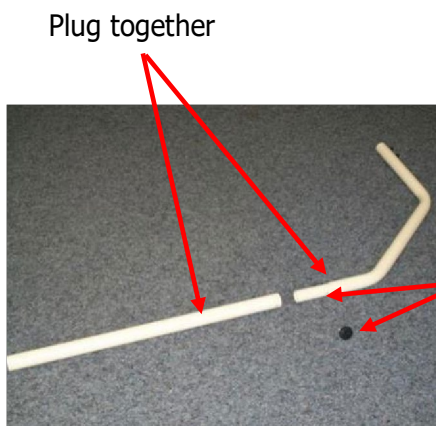

Plug together

Erector admission

Screw the star grip screw into the threaded hole and tighten.

Engage the snap-in cylinder pin in the recess



The length of the strap of the triangle handle can be adjusted by the buckle. Select an adjustment that allows the user to easily reach the handle when lying down (usually between 55-70 cm measured from the upper edge of the mattress).

Make sure that the belt is securely fastened again.

The triangle handle has a shelf life of at least 5 years under normal use (see embossing of production date). It is then recommended to replace the triangle handle.

Slide the fixed loop of the triangle belt over the first bolt of the erector and check its secure hold by pulling the triangle handle firmly downwards.

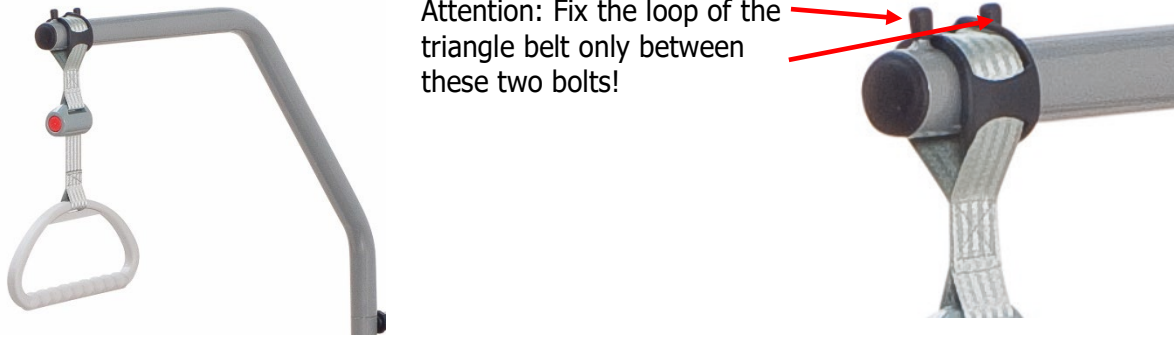

5.5 Foldable side rails (accessories- item number BC 1.19.0270000)

Prius Healthcare side rails are available as accessories for the Descend nursing beds. The intended use of the side rails is the installation exclusively on the Descend. The use of the optional side rails reduces the risk of the patient falling out of the Descend unintentionally. The side rails are not designed to prevent the patient from leaving the bed intentionally.

Any other use is considered improper and is excluded from possible liability.

5.5.1 Safety instructions when using the steel side rails

- ⚠ Only use side rails approved by Prius Healthcare as optional accessories (item number BC 1.19.0270000).
- ⚠ The use of incompatible side rails is not permitted and can lead to hazards, e.g. due to trapping.
- ⚠ The distance between two side rails lying one above the other or between the lower edge of the lower side rail and the lying surface must not exceed 12 cm.
- ⚠ Only instructed personnel may assemble/disassemble the side rails.
- ⚠ When using the side rails, their suitability must be assessed by the attending physician or a nurse, considering the individual needs and abilities of the patient.
- ⚠ During operation of the adjustment functions of the nursing bed, no parts of the patient's body may protrude over the lying surface or touch the side rails.
- ⚠ The side rails only offer protection against rolling out when the backrest and knee adjustment are in the horizontal position.
- ⚠ Under no circumstances should side rails be used improperly (e.g. for climbing over or supporting).
- ⚠ The distance between the top edge of the side rail and the top of the mattress in non-compressed condition must be at least 22 cm.
- ⚠ When using side rails, there is an increased risk of crushing and clamping.

5.5.2 Assembly of the steel-side rails

Proceed as follows to install the steel side rails:



1. Remove the black caps from the pre-drilled holes on the bed frame of the Descend.

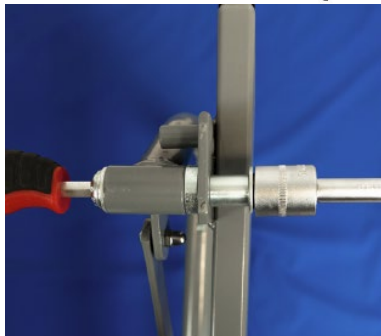
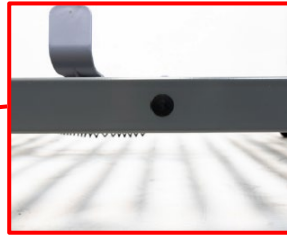

2. Loosen the nuts on the side rail.



3. Place the side rail on the bed frame tube so that the screws fit into the existing holes.

It is easier if you remove the mattress first and put the head- and footrest up)



4. Tighten the nuts again

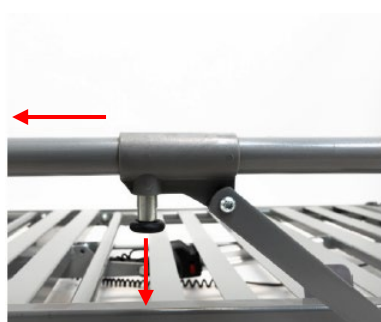

5. To fold in the side rail, pull on the locking bolt



6. Push the side rail with the unlocked bolts to the side until it is completely folded in.

 After installing the side rails, check that they are securely attached to the mattress base frame.

 After folding up the side rail, the locking bolt must be fully engaged again. Check the strength of the folded up side rail.

5.6 Commissioning

The Descend care bed is ready for operation after it has been successfully carried out and all steps from chapter 5, paras. 5.3 and 5.5 have been observed. Once the Descend has been installed, carry out a check in accordance with Chapter 9, Section 9.2.

Clean and disinfect the bed before using it for the first time and before each use according to chapter 7. Place your mattress on the lying surface of your Descend. The mattress dimensions must correspond to the dimensions of the lying surface.

Connect the mains plug into the mains socket.

 The mains plug must always be accessible so that in an emergency the system can be disconnected from the mains supply by pulling it out of the socket.

Make sure that the power cord is not crushed or driven over.

The Descend nursing bed can now be used.

5.7 Disassembling the Descend care bed

Always disconnect the mains plug from the socket before dismantling!
Disassembly of the care bed is carried out in reverse order to the assembly.

6 Functional description

6.1 Technical overview of the Descend

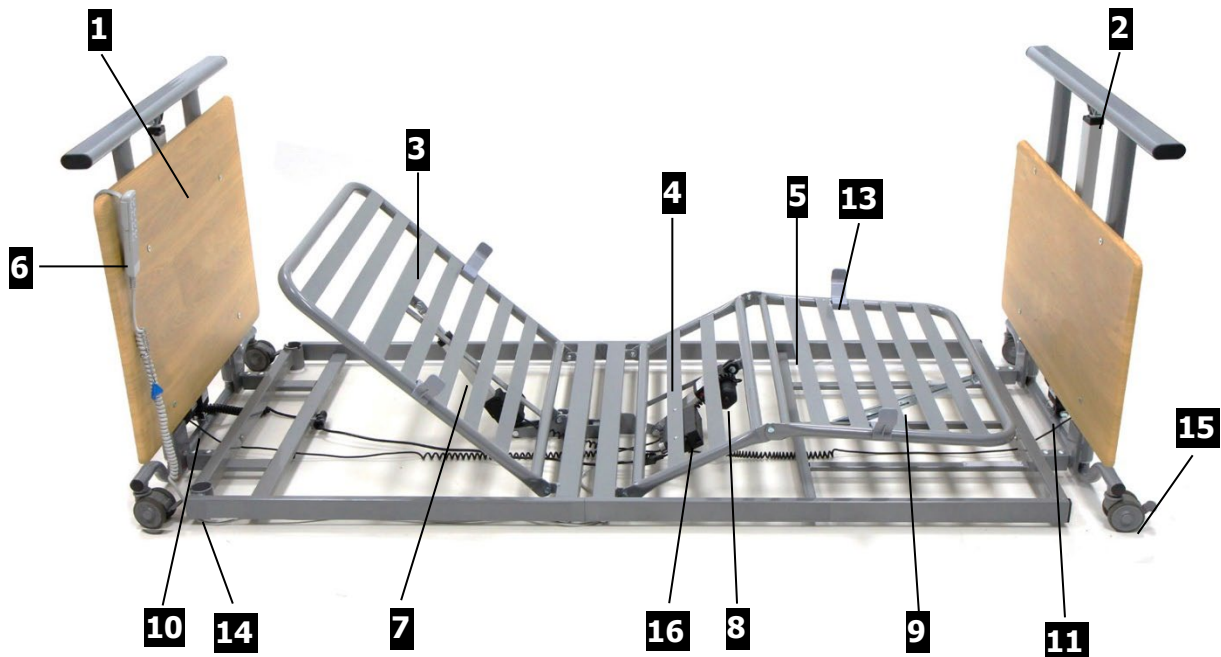

- 1 Bed control unit on the head side with integrated height adjustment drive
- 2 Bed control unit on the foot side with integrated height adjustment drive
- 3 Electrically adjustable backrest
- 4 Electrically adjustable thigh support
- 5 Mechanically adjustable lower leg support
- 6 Hand control with nurse key
- 7 Electric drive for backrest
- 8 Electric drive for thigh support
- 9 Mechanical latching mechanism for adjusting the lower leg support
- 10 Electric height adjustment drive for the head side
- 11 Electric height adjustment drive on foot side
- 12 Power supply unit with SMPS, mains cable and mains plug
- 13 Mattress holder
- 14 Tube holder for erecting bracket (on both sides)
- 15 Mechanically lockable track roller
- 16 Control unit



6.2 Hand control with locking function

The electric bed functions can be operated via the handset. All functions can be locked with the nurse key.



In order to avoid damage, the hand control should always be suspended from the hand control hook when not in use. (e.g. bed control unit)

 Do not press multiple keys at the same time as this may overload and damage the system.

6.3 Locking function for handset

There is a lock on the back of the hand control. All electrical adjustment functions can be locked simultaneously by turning the enclosed nurse key in the lock.



Switching positions I and II are test positions used to check safety during regular safety checks or after repair work.

6.4 Operation of the lockable track rollers

All rollers of the bed can be locked individually and must always be locked during normal operation. This is total locking, i.e. directional locking and simultaneous braking of the roller.



Released brake

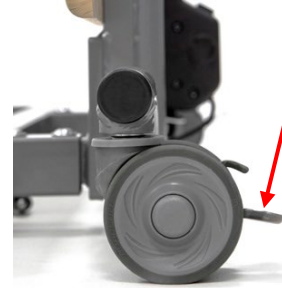

Lock the brake with your foot.



Attention: The brakes may only be released to move the bed!

See also safety instructions!

6.5 Emergency lowering

6.5.1 Emergency lowering via integrated 9V battery (electric)

The control unit mounted on the lying surface is equipped with a 9V block battery, which enables the individual electrical adjustment functions to be lowered in the event of a mains power failure. If the mains power should fail, you have the option of returning the electric drives to their lowest position. Please note that this is only possible once per 9V battery, as the capacity of the 9V battery is very limited.



After using the emergency lowering once, the 9V battery must be replaced with a new equivalent one (alkaline manganese battery type 6LR61).

However, the 9V battery should be replaced every 2 years even if not in use.

6.5.2 Battery change

To replace, check or remove the 9V battery for longer storage, the battery compartment of the control unit must be opened.

1. Disconnect the mains plug!
2. Remove the cover on the control unit by unscrewing the two crosshead screws.
3. Pull out the cover together with the 9V battery.
4. Disconnect the battery from the battery clip and replace it with a new equivalent battery of the type "alkaline manganese battery type 6LR61".

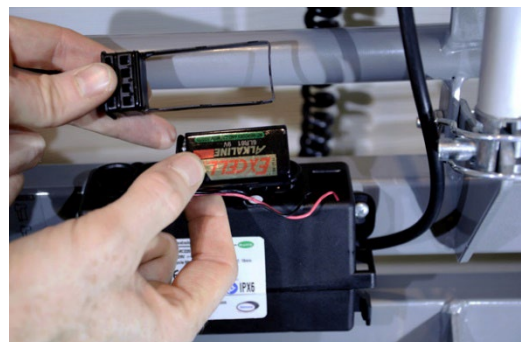



5. Slide the cover with the new 9V battery back into the opening of the control unit. Make sure that the seal is not damaged.

6. Finally fasten the cover to the control unit with both screws. Make sure that the screws are not overtightened during tightening.

6.5.3 Emergency lowering of the backrest (manual)

If the backrest must be lowered in less than 30 seconds in the event of a power failure or the Descend electric drive system has failed, you can lower the backrest manually.

-  Observe these safety and implementation instructions, as non-compliance can lead to uncontrolled falls from the backrest and thus to serious injuries for the user and the patient!
-  Always carry out the emergency lowering of the backrest by hand with two users!
-  Manual emergency lowering may only be carried out by instructed users and should be practised several times under normal conditions in order to be able to lower the backrest safely in an emergency.

Execution of mechanical emergency lowering:

1. The first user relieves the backrest before the emergency lowering by lifting the frame and holding it in this position. If necessary, the second user supports this procedure.
2. The second user unfolds the bent safety clip of the socket pin at the head end of the backrest drive.
3. Then he pulls the socket pin out of the lifting rod. The drive is now separated from the backrest and swivels downwards.
4. Both users lower the backrest slowly and in a controlled manner.

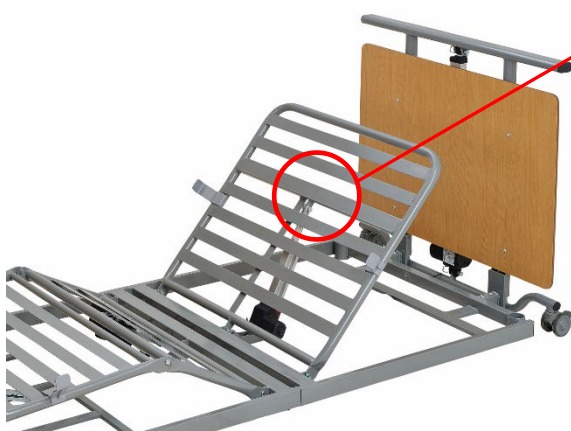

Loosen this socket pin on the backrest drive for manual emergency lowering.

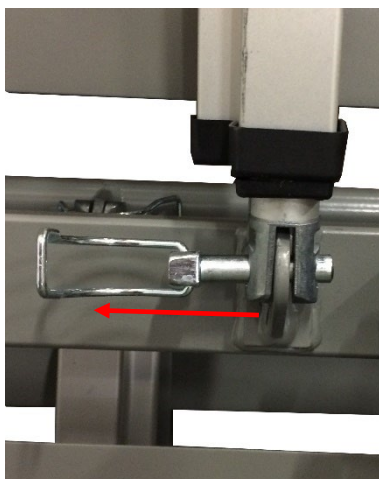

Open the safety clip on the socket pin and pull out the socket pin.

Restoration of the original condition:

1. Swivel the lifting rod of the drive up again in the direction of the backrest.
2. Insert the socket pin into the mounting of the lifting rod and the bed frame.
3. Make sure to reinsert the socket pin from the operator side so that it is always accessible.
4. Close the safety clip on the socket pin.

6.6 Trendelenburg / Reverse Trendelenburg function (option)

As an option, the Descend nursing bed can be equipped with Trendelenburg or Reverse Trendelenburg bearings.

With Trendelenburg bedding, the lying surface of the nursing bed is inclined in the headroom bedding. With Reverse Trendelenburg positioning, the lying surface is inclined to the low foot position.



Trendelenburg positioning may only be used at the instigation of a doctor, as it can influence the clinical condition of the patient.



Do not leave the patient unattended during Trendelenburg or Reverse Trendelenburg positioning.



Lock the Trendelenburg function when using the care bed in application environment 4 (home care).

Push-button for Antitrendelenburg function (inclination of the lying surface to the low foot position)



Push-button for Trendelenburg function (inclination of the lying surface to the head low position)

7 Care, cleaning and disinfection

Clean and disinfect the Descend care bed before using it for the first time and before using it again. For cleaning, wipe the bed by hand with a damp cloth. We recommend suitable cleaning and care products as cleaning agents for wooden and plastic furniture.

Household cleaners without ammonia and scouring agents are also permitted but should be dermatologically tested.

Solvents and scouring agents are not permitted as they attack and damage the various surfaces of the care bed.

For disinfection:

Indication:

In order to achieve effective disinfection, the nursing bed must be cleaned beforehand.

Disinfection is possible by spray or wipe disinfection with commercially available disinfectants. Do not use disinfectants containing chlorine as they can have a corrosive effect on metals, plastics etc. and are not environmentally friendly.

For wipe disinfection (surface disinfection) we recommend approved disinfectants and disinfection procedures from the list of disinfectants and disinfection procedures tested and approved by the Robert Koch Institute (<https://www.rki.de>) or from the VAH disinfectant list (Verbund für Angewandte Hygiene e.V. / <https://vah-online.de>).



Lebensgefahr

Before cleaning and disinfection, the mains plug must be disconnected from the mains and securely suspended. The plug for the handset and the motors, which are plugged into the control at the lying surface drive, must be plugged in. This is necessary so that no water can penetrate the control unit.



The electrical components must not be sprayed with a high-pressure cleaner or water jet. Only wipe disinfection is permitted.

8 Cause and remedy of malfunctions

Not every malfunction is directly attributable to a defect in the nursing bed. Before contacting your dealer or Prius Healthcare, please check the malfunction using the table below.

Malfunction	Possible cause	Remedy
No function of the drives	Mains plug not connected	Connect mains plug
	Lock function on hand control activated	Unlock the hand control.
	Hand control not plugged in	Insert the hand control into the control unit.
	Drive not plugged in	Plug the drive into the control unit.
Reversed adjustment functions	Connection cable on the connectors reversed	Check plugs and connectors and reinsert.
No function after power failure	9V block battery is empty	Replace 9V block battery
Bed moves very slowly	Bed can only be adjusted via battery. Mains plug not plugged in	Plug in the mains plug and replace the 9V block battery preventively.

9 Maintenance

9.1 Fundamentals

In accordance with MPBetreibV §7 (as of 2021), operators of care beds are obliged to ensure the safe and proper operation of the medical device on an ongoing basis by means of maintenance measures (inspection and maintenance).

The service life of the care bed depends essentially on the handling and maintenance. To ensure safe operation, we recommend that a visual and functional check, including an electrical check, be carried out at least once a year and before each reuse as a guide value. This should be carried out under your own responsibility and with verifiable compliance with the 2% error rate (see also DGUV regulation 3 §5, table 1B). If an error rate of <2% is demonstrably achieved during the electrical test, the test cycle can be extended to a maximum of two years.

Carry out maintenance at least once a year and before each reuse in accordance with the maintenance schedule and the test regulations in accordance with IEC 62353 in its current version.

The following tests according to IEC 62353 apply to our care beds:

1. Visual inspection
2. Leakage current measurement
3. Insulation resistance measurement
4. Functional test
5. Overall assessment and documentation



If you have any doubts about the safety or function of any part of the bed during the work described below, the bed must never be put back into operation. Then contact the supplier or manufacturer.



Maintenance, inspection and repair work are not allowed to be carried out on the nursing bed when it is in use and the patient is in it.



Electrical components must not be opened and must be replaced. Defective electrical components must be replaced by qualified personnel.



The electrical tests described here in accordance with IEC 62353 may only be carried out by a qualified electrician or, if suitable measuring and testing equipment is used, by a person trained in electrical engineering.

9.2 Maintenance plan

Care bed DESCEND
type

Serial No.: Responsible:

Location: Inspector:

Pos.	Test instruction	OK	n. OK	Comment
1.	Examination of the basic prerequisite			
1.1	Is the general condition okay?			
1.2	Type plate of the nursing bed and the electrical components legible?			
1.3	Instruction manual available and accessible to personnel?			
1.4	Appropriate and safe use?			
1.5	Will the side rails be used appropriately?			
2.	Visual inspection			
2.1	No surface damage or corrosion?			
2.2	Mechanical components and welds without defects?			
2.3	All mechanical connecting elements are tight?			
2.4	Lying surface floor without damage?			
2.5	Firm fit and no damage to the head and foot end pieces?			
2.6	All 4 rollers undamaged and tight?			
2.7	Parking brakes are undamaged and tight?			
2.8	Erector with grab handle and erector holder undamaged and no wear?			
2.9	Mains cable, connecting cables and plugs without damage?			
2.10	Transport protection for mains plug available?			
2.11	Strain relief for mains cable and handset securely fastened?			
2.12	Are all plug connections firmly plugged in? (sealing rings without damage)			
2.13	Correct and safe cable laying? (no damage)			
2.14	Motor, SMPS power supply and mains plug housings without damage?			
2.15	Hand control without damage?			
2.16	Thrust tubes of the height adjustment drives are undamaged?			
2.17	Socket pin with safety bracket on backrest drive is freely accessible for mechanical emergency lowering?			
2.18	9V block battery OK / expiration date enough until next test?			
2.19	Is the safe working load maintained?			
2.20	No surface damage, corrosion or deformities on the side rails?			
3	Electrical test according to IEC 62353			
3.1	Insulation resistance >7MΩ? Measured value:			
	Device leakage current <0.5mA? Measured value:			
3.2	The measurement of the device leakage current does not have to be carried out in the normal life expectancy of the care bed (within the first 10 years) if the visual and functional test has been passed if these care beds are equipped with a drive set from the manufacturer limoss and a power supply unit (SMPS) from the manufacturer limoss. With these care beds, the incoming mains voltage is converted into a protective low voltage of 29V in the power supply unit (SMPS).			

4	Functional test		
4.1	All adjustment possibilities of the care bed without obstacles on site?		
4.2	Does the locking mechanism for lower leg adjustment work?		
4.3	Stress test successfully carried out according to regulations?		
4.4	Function test of the handset: correct operation of the keys?		
4.5	Function test of the handset locking device: On/Off OK?		
4.6	Check of the first-error safety by means of an integrated locking box in the handset without complaint?		
4.7	Track rollers, easily rotatable by 360°?		
4.8	Wheels, individual parking brakes are functional (enough braking effect available)?		
4.9	When using the steel side rails		
	Side rails height above the mattress at least 22cm?		
4.10	Are all screws on the side rail (2 pieces per side rail) present and screwed tight?		
4.11	Locking bolt without damage and fully engages.		

Overall rating

Overall assessment of the Descend in order?

Observations:

.....

.....

Place / Date: Inspector:

Next exam: Signature:



9.3 Check of first-error safety by means of locking function in manual switch

Proceed as follows to check the safety device:

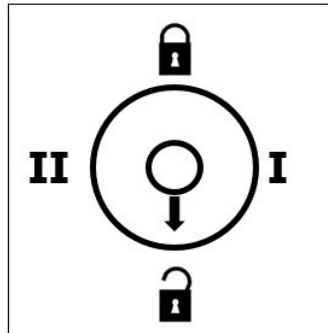
-  The switching positions I and II are test settings which are used for the safety checks as part of the annual inspection or after repair or before each re-use of the care bed.



Check the switch positions on the back of the handset using the following four points:

- Switch position adjustment : Move all bed adjustments to a slightly raised position.
- Setting the switch position : Electrical adjustments must not be possible when the adjustment keys are pressed.
- Set the switch on the back of the hand control to test position **I**: Electrical adjustments must not be possible when the adjustment keys are pressed.
- Move the switch on the back of the handset to test position **II**: Electrical adjustments must not be possible when the adjustment keys are pressed.

10 Warranty

Within the scope of our terms of delivery and payment, we guarantee the perfect condition of our care beds.

In the event of unauthorised modifications to the product, improperly carried out maintenance work and use contrary to the instructions for use, warranty and product liability claims shall lapse.

11 Useful life and disposal

The service life naturally depends on the way in which the bed is used. With correct operation and appropriate use, this care bed has an expected service life of 7 to 10 years.

The Descend nursing beds are suitable for re-use in accordance with the measures in chapters 7 and 9. Frequent transport, installation and adjustment reduce the service life just as much as improper handling, irregular maintenance and exceeding the safe working load or permissible load cycles of the electric drives. The healthcare bed must not be disposed of with normal household waste at the end of its service life. For environmentally friendly disposal, please contact your local authority or Prius Healthcare.



The electrical components (power supply units, control units, drives and hand controls) of these beds are to be treated like electronic waste in accordance with WEEE Directive 2012/19/EU (Waste Electrical and Electronic Equipment) and disposed of properly.

The components used conform to the directive 2011/65/EU (RoHS II) on the restriction of the use of certain hazardous substances in electrical and electronic equipment.

12 Technical specifications

12.1 Technical data (mechanical)

Safe working load (max. permissible load)	180kg	
Individual loads of the safe working load	Max. patient weight	170kg
	Mattress 200x90x12cm	10kg
	Total	180kg
Safe erecting load (optional)	80kg	
Max. patient weight	170kg	
Max. Mattress height	20cm	
Total length	2170mm (with 2000mm long lying surface)	
Total width	900mm (with 900mm wide lying surface)	
Height of upper edge of head/foot section	846 – 1419mm	
Height adjustment of lying surface	electric stepless from 67-640mm	
Backrest adjustment	electric stepless up to approx. 70°	
Thigh rest adjustment	electric stepless up to approx. 30°	
Foot elevation	mechanical, -20° to 0° in 5 steps	
Lying surface floor	Steel spring connectors	
Individual weights / empty weight	Half of the lying surface head side:	24kg
	Half of the lying surface foot side:	23,5kg
	Bed control parts:	13kg each
	Side rails (optional) per	5kg
	Empty weight:	73kg
Track rollers	Ø 75mm double plastic rollers	
Materials	frame, lying surface, side rails etc:	steel (powder-coated)
	Headboard and footboard:	wood-based material (veneered)
	Electronic components:	plastic and aluminum
Operating noise	<53 dB(A) at 1m	

12.2 Technical data (electrical)

Control + power supply SMPS	MC220 + MC125 (Limoss Company)
Hand control:	HC 148
Nominal voltage	230V
Nominal frequency	50/60Hz
Current type	AC~
Max. power consumption	2,1 A
Rated recording in idle state	0,5 Watt
Rated operation/nominal rest time	2Min/18Min (max. 5 switching cycles/min)
Primary fuse	2,0 A
Emergency lowering battery	9V block battery (alkaline manganese type 6LR61)
Reclining surface drive back part	1xMD125 (Limoss Company)
Reclining surface drive foot part	1xMD125 (Limoss Company)

Height adjustment drive 2xMD121 (Limoss Company)
 Protection class of the drives IPX4 (protection against splashing water on all sides)

12.3 Technical data environment

Temperature range operation +10°C to +40°C
 Temperature range storage/transport -10°C to +60°C
 Air humidity 30% to 75% rel.
 Air pressure between 795 and 1060 hPa

12.4 Classification

Medical device Class 1
 Degree of protection according to IEC 60601-1 Application part of type B (Protection against electric shock) 
 Housing protection class according to IEC 60529 IPX4 (protection against splashing water on all sides, but not suitable for tunnel washers)
 Max. Duty cycle 10%, On 2Min/Off 18Min
 Max. Switch-on cycles / min 5
 Safety inspections 1x yearly

12.5 Identification plates

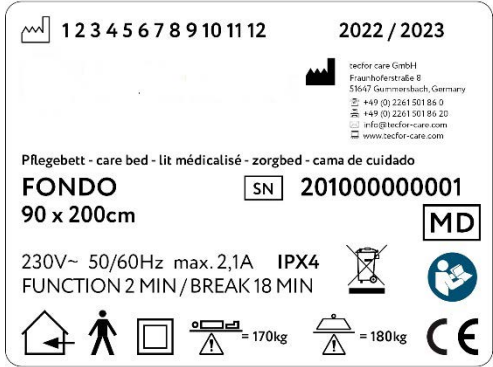
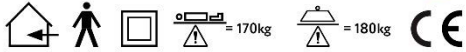
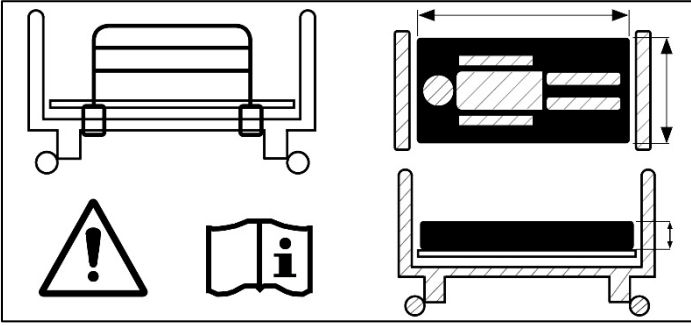
 <p>1 2 3 4 5 6 7 8 9 10 11 12 2022 / 2023</p> <p>tedfor care GmbH Fraunhoferstraße 8 51647 Gummersbach, Germany ☎ +49 (0) 2261 501 86 0 ✉ info@tedfor-care.com www.tedfor-care.com</p> <p>Pflegebett - care bed - lit médicalisé - zorgbed - cama de cuidado FONDO SN 201000000001 90 x 200cm MD</p> <p>230V~ 50/60Hz max. 2,1A IPX4 FUNCTION 2 MIN / BREAK 18 MIN</p> <p></p>	<p>Identification plate Position: Glued to the right inside of the lying surface frame</p>
	<p>Note: 1) Exchangeable mattresses 2) Removable side rails</p> <p>Position: Frame upper side of the bed lifting frame at the foot side</p>

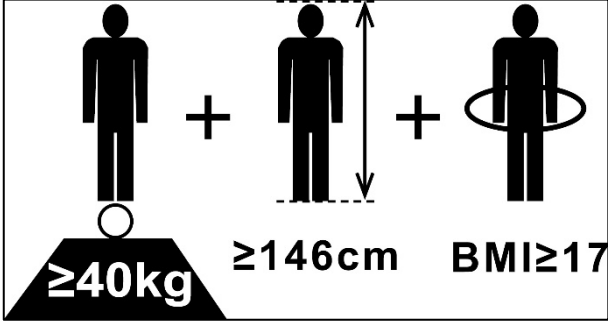
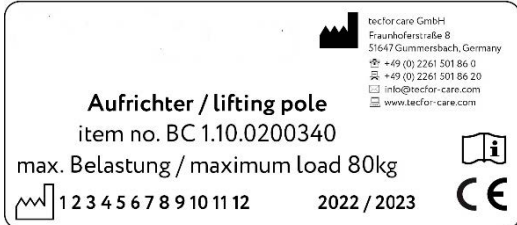
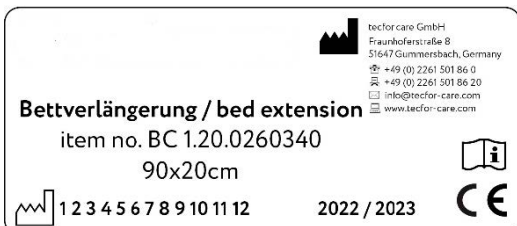
	<p>Note: Use of the care bed for adults</p> <p>Position: Frame upper side of the bed lifting frame at the foot side</p>
	<p>Identification plate erector (option)</p> <p>Position: Erector</p>
	<p>Identification plate bed extension (option)</p> <p>Position: Top side bed extension</p>

12.6 Information on electromagnetic compatibility

The Descend care bed meets the normative requirements with regard to its electromagnetic interference emissions and its immunity to interference. Therefore, if the care bed is used as intended, no functional restrictions are to be expected due to possible electromagnetic interference from adjacent electrical devices.



Attention:

Nevertheless, the use of the care bed in the immediate vicinity of other electrical devices should be avoided in order to prevent the care bed from malfunctioning due to electromagnetic interference. If it is necessary to use the care bed in addition to other electrical devices, the proper functioning of the care bed and these devices should be observed.



Only spare parts (mains cable, handset, motors, etc.) and accessories that have been approved by the manufacturer Prius Healthcare may be used in order to be able to guarantee trouble-free operation of the care bed.



The use of other accessories, other converters and other cables than those provided by Prius Healthcare for this care bed can result in increased electromagnetic interference emissions or reduced electromagnetic interference immunity of the care bed and lead to faulty operation.



Portable HF communication devices (mobile phones, two-way radios, etc.) including their accessories (e.g. antenna cables and external antennas) should not be used within a distance of less than 30cm from the electrical components and cables of the Descend care bed. Non-observance can lead to a reduction in the performance characteristics of the care bed.



HF surgical devices must not be used on Descend care beds, as this can lead to unforeseeable malfunctions in the care bed.



The Descend care bed is intended for use in the following specified electromagnetic environment during its entire service life in order to maintain basic safety and functional characteristics.

The operator or user of the care bed should ensure that it is used in such an environment.

The Descend care bed meets the requirements of the following EMC standards for interference emission and interference immunity:

Ambient limit values of the interference emissions	
Phenomenon	operation site in the field of medical care in a home environment
Conducted and radiated interference emissions	CISPR 11, Group 1, Class B
Harmonic distortions	see IEC 61000-3-2
Voltage fluctuations and flicker	see IEC 61000-3-3

Sheathing		
Phenomenon	EMC basic standard or test method	Immunity test level
Electrostatic discharge	IEC 61000-4-2	± 8 kV contact ± 2 kV, ± 4 kV, ± 8 kV, ± 15 kV air
High-frequency electromagnetic fields	IEC 61000-4-3	10 V/m ;(80 MHz up to 2,7 GHz; 80% AM at 1 kHz)
High-frequency electromagnetic fields in the immediate vicinity of wireless communication devices	IEC 61000-4-3	see table Test specifications for the immunity of sheathings to high-frequency wireless communication equipment (at the end of this chapter)
Magnetic fields with energetically rated frequencies	IEC 61000-4-8	30 A/m, 50 Hz or 60 Hz
Magnetic fields at close range	IEC 61000-4-39	no magnetically sensitive components, therefore no immunity rating required

AC port for supply input		
Phenomenon	EMC basic standard or test method	Immunity test level
Short, transient electrical disturbances / bursts	IEC 61000-4-4	± 2 kV, 100 kHz repetition frequency
Surges: conductor to conductor	IEC 61000-4-5	± 0,5 kV, ± 1kV
Conducted interference induced by high-frequency fields	IEC 61000-4-6	3 V 0,15 MHz up to 80 MHz 6 V in ISM and amateur radio frequency bands between 0,15 MHz and 80MHz 80 % AM at 1kHz
voltage dips	IEC 61000-4-11	0% U_T ; ½ period at 0, 45, 90, 135, 180, 225, 270 and 315 degree 0% U_T ; 1 period and 70% U_T ; 25/30 periods single-phase at 0 degree
voltage interruptions	IEC 61000-4-11	0% U_T ; 250/300 periods

DC port for supply input		
Phenomenon	EMC basic standard or test method	Immunity test level
Short, transient electrical disturbances / bursts	IEC 61000-4-4	± 2 kV 100 kHz repetition frequency
Surges: conductor to conductor	IEC 61000-4-5	± 0,5 kV, ± 1kV
Surges: conductor to earth	IEC 61000-4-5	± 0,5 kV, ± 1kV, ± 2kV
Conducted interference induced by high-frequency fields	IEC 61000-4-6	3 V 0,15 MHz up to 80 MHz 6 V in ISM and amateur radio frequency bands between 0,15 MHz and 80MHz 80 % AM at 1kHz

Patients' connection ports		
Phenomenon	EMC basic standard or test method	Immunity test level
Electrostatic discharge	IEC 61000-4-2	± 8 kV contact ± 2 kV, ± 4 kV, ± 8 kV, ± 15 kV air
Conducted interference induced by high-frequency fields	IEC 61000-4-6	3 V 0,15 MHz up to 80 MHz 6 V in ISM and amateur radio frequency bands between 0,15 MHz and 80MHz 80 % AM at 1kHz

SIP/SOP-Tor (Signaleingangs-/Signalausgangsteilen)		
Phenomenon	EMC basic standard or test method	Immunity test level
Electrostatic discharge	IEC 61000-4-2	± 8 kV contact ± 2 kV, ± 4 kV, ± 8 kV, ± 15 kV air
Short, transient electrical disturbances / bursts	IEC 61000-4-4	± 1 kV 100 kHz repetition frequency
Conducted interference induced by high-frequency fields	IEC 61000-4-6	3 V 0,15 MHz up to 80 MHz 6 V in ISM and amateur radio frequency bands between 0,15 MHz and 80MHz 80 % AM at 1kHz

Test specifications for the immunity of sheathings to high-frequency wireless communication equipment				
Test Frequency (MHz)	Frequency band (MHz)	Radioservice	Modulation	Immunity test level (v/m)
385	380 to 390	TETRA 400	Pulse modulation 18 Hz	27
450	430 to 470	GMRS 460, FRS 460	FM ± 5% lift, 1kHz sine	28
710	704 to 787	LTE band 13, 17	Pulse modulation 217 Hz	9
745				
780				
810	800 to 960	GSM 800/900, TETRA 800 iDEN820, CDMA 850, LTE Band 5	Pulse modulation 18 Hz	28
870				
930				
1720	1700 to 1990	GSM 1800, CDMA 1900, GSM 1900, DECT, LTE band 1;3; 4; 25; UMTS	Pulse modulation 217 Hz	28
1845				
1970				
2450	2400 to 2570	Bluetooth, WLAN 802.11 b/g/n, RFID 2450, LTE band 7	Pulse modulation 217 Hz	28
5240	5100 to 5800	WLAN 802.11 a/n	Pulse modulation 217 Hz	9
5500				
5785				

 The minimum distances for higher immunity test levels shall be calculated using the following equation.

$$E = \frac{6}{d} \sqrt{P}$$

P = maximum power in watts (W)
 d = Minimum distance in meters (m)
 E = Immunity test level in volts per meter (V/m)

If a test with these increased test levels is passed, the stated minimum distance of 30cm can be replaced by the new minimum distance calculated for the increased immunity test levels.

13 Declaration of conformity

EU Declaration of Conformity

We, the company

tecfor care GmbH
Fraunhoferstraße 8
51647 Gummersbach
Germany
SRN: DE-MF-000007722

declare under our sole responsibility that

the medical device: **Bed-in-Bed-System / bed type low bed
Fondo**
(item number: ULB 9.02.0343341)

Basis-UDI-DI: 426067976TVC-BE-BiB-ULBTA

complies with all applicable requirements of the Regulation (EU) 2017/745.
The associated documentation shall be kept on the premises of the manufacturer.

classification according to
Article 51(1) and Annex VIII:

class I,
rule 1 und 13:

The applied conformity assessment procedure is in compliance with Article 52(7).

The product also meets the requirements of Directive 2011/65/EU.

This declaration of conformity loses its validity if the product is modified without consultation with the manufacturer.

Gummersbach, 01.07.2022

A handwritten signature in black ink, appearing to read "R. Knabe".

Robin Knabe (Managing directors)



Prius Healthcare USA, LLC
160 Scarlet Blvd
Oldsmar, FL 34677 USA

Phone: 813-854-5464
Mail: info@priushc.com
Web: www.priushcusa.com