



POSITIVE POSTURE®

BRIO<sup>+</sup> MASSAGE CHAIR  
OWNER'S MANUAL

---

Before you start using your massage chair, please read this manual thoroughly for the correct methods of usage, especially taking note of the section on safety.

This manual should be kept on hand for easy reference. It is your guide to safe and efficient operation.

This product is designed for home use.

---

Model PP7913E

# CONTENTS

---

Introduction.....	2
Cautions & Warnings.....	3
Main Features.....	11
Parts & Functions.....	12
Assembly.....	14
Moving the Chair.....	20
Remote Functions.....	21
Sessions.....	24
Operation & Use.....	25
Care & Storage.....	31
Troubleshooting.....	32
FAQ.....	34
Warranty & After Sales Service.....	35
Specifications.....	36

*Note: The pictures in this manual are only for reference. Please refer to the actual product.*

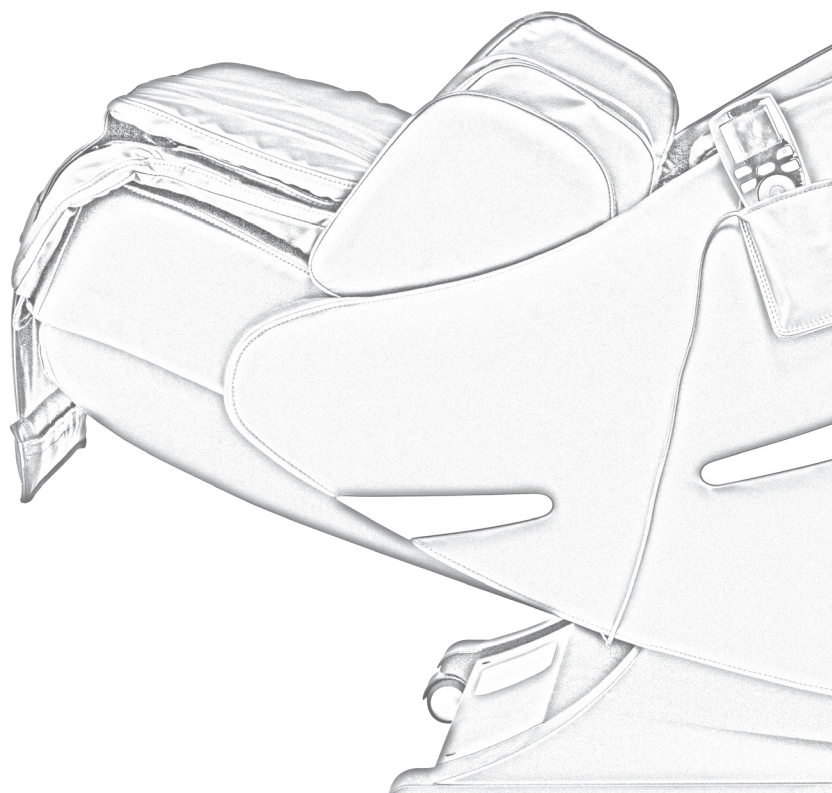

# INTRODUCTION

---

Congratulations on your recent Positive Posture massage chair purchase!

Massage combined with healthy eating, exercise, and a good sleep regimen is a great way to live a happy, productive life. We're confident that your new massage chair will provide you with many years of relaxation.

Your new Positive Posture massage chair includes a 3-year limited in-home warranty. If you have any questions or issues during or after the warranty period, **please contact Positive Posture directly** by calling or sending an email to [service@positiveposture.com](mailto:service@positiveposture.com).



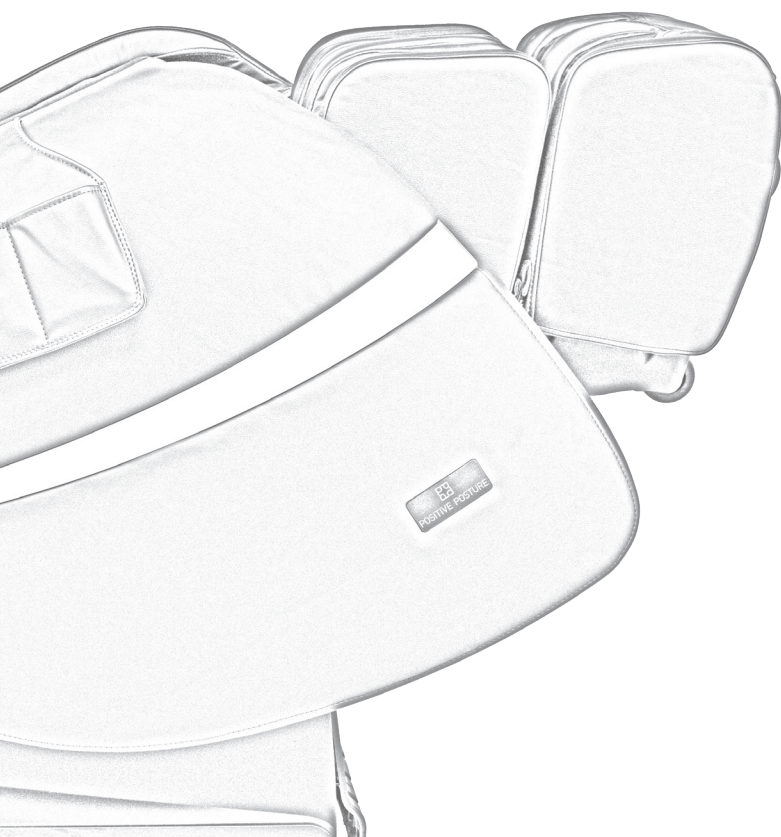



Thank you again for making Positive Posture a part of your daily life.



# CAUTIONS & WARNINGS

---

## Indications, Symbols, & Descriptions

 WARNING	This action could result in serious injury or death
 CAUTION	This action could result in personal injury or damage to property
	This action is prohibited
	Further action is required
	Do not disassemble
	Unplug power cord from wall outlet

### Important Safety Precautions

- Please follow all basic precautions while using this chair.
- Please read all instructions before using this massage chair. Refer to your Owner's Manual for important information about assembly as well as correct and safe procedures for using the chair.
- The above symbols are used to identify important safety instructions. Please familiarize yourself with these symbols and their meanings.
- Remember to keep this operating manual in an easily accessible place.

## General Safety



### TO REDUCE THE RISK OF ELECTRIC SHOCK

Always unplug this appliance from the electrical outlet immediately after using and before cleaning.



### TO REDUCE RISK OF BURNS, FIRE, ELECTRIC SHOCK, OR INJURY TO PERSONS

- An appliance should never be left unattended when plugged in. Unplug from outlet when not in use and before putting on or taking off parts.
- Do not operate under blanket or pillow. Excessive heating can occur and cause fire, electric shock, or injury to persons.
- Close supervision is necessary when this appliance is used by, on, or near children, invalids, or disabled persons.
- Use this appliance only for its intended use as described in this manual. Do not use attachments not recommended by the manufacturer.
- Never operate this appliance if the cord or plug is damaged, if it is not working properly, if it has been dropped or damaged, or if it has been exposed to water. If this happens, contact the service center for examination and repair.
- Do not carry this appliance by the supply cord or use the cord as a handle.
- Keep the cord away from heated surfaces.
- Never operate the appliance with air openings blocked. Keep the air openings free of lint, hair, etc.
- Never drop or insert any object into any opening.
- Do not use outdoors.
- Do not operate where aerosol (spray) products are being used or where oxygen is being administered.
- To disconnect, turn all controls to the off position, then remove plug from the outlet.
- Use heated surfaces carefully. May cause serious burns. Do not use over areas with sensitive skin or in the presence of poor circulation. The unattended use of heat by children or incapacitated persons may be dangerous.
- Keep children away from extended foot support (or other similar parts).
- Connect the appliance to a properly grounded outlet only. See Grounding Instructions.

# CAUTIONS & WARNINGS

## Grounding Instructions

This product must be grounded. If it should malfunction or breakdown, grounding provides a path of least resistance for electric shock. This product is equipped with an equipment-grounding conductor and a grounded plug. The plug must be plugged into an appropriate outlet that is properly installed and grounded in accordance with all local codes and ordinances.

**DANGER: Improper connection of the equipment-grounding conductor can result in a risk of electric shock. Check with a qualified electrician or serviceman if you are in doubt as to whether the product is properly grounded. Do not modify the plug provided with the product—if it will not fit the outlet, have a proper outlet installed by a qualified electrician.**

This product is for use only on a nominal 120V circuit and has a grounded plug that looks like the plug illustrated in Figure A below. Make sure that the product is connected to an outlet having the same configuration as the plug. An adapter should never be used with this product, such as shown in Figure B below.

YES

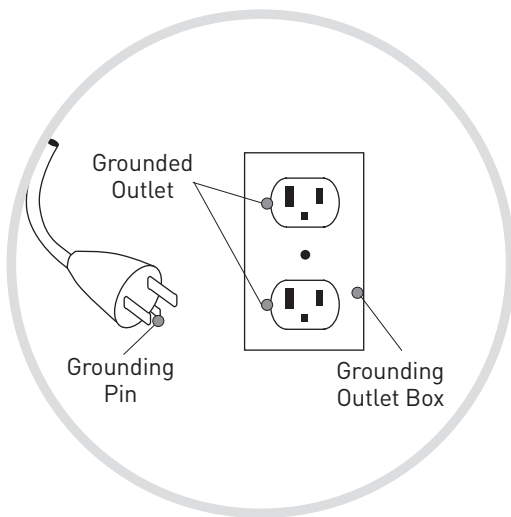

Figure A

NO

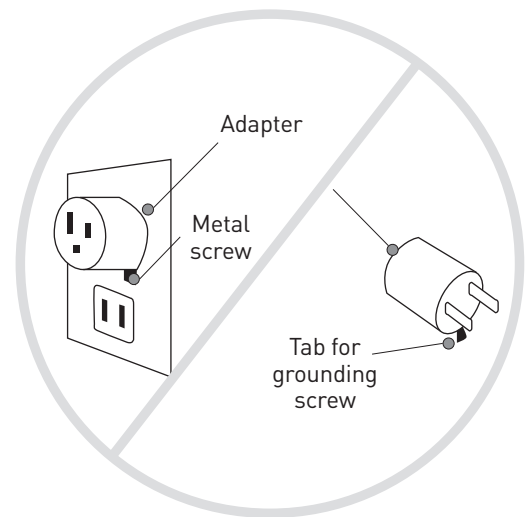

Figure B

## Safety During Installation



- This product uses a normal Alternating Current (AC) circuit and has a ground pin as displayed in the figure to the right. Always make sure that the chair is connected to an outlet that has the same configuration as the plug, and is fully inserted into the outlet. If the chair should malfunction or break down, the grounding will provide a path of least resistance for electrical current to help reduce the risk of electric shock.
- This chair must be plugged into an appropriate outlet that has been properly installed and grounded in accordance with all local codes and ordinances. It is recommended to always use a surge protector.
- Do not use with any type of transformer device.
- Do not use the chair with a power supply other than those shown in the image on page 5 (Model, Power Supply AC120V).
- Make sure the main switch is in the OFF position before inserting the plug into the outlet.
- Any modification of the plug provided is prohibited and can cause serious injury. If the plug does not fit into an outlet, contact a qualified electrician for proper installation.
- Failure to connect the grounding conductor of the chair can result in the risk of electrical shock. If you feel the product is not properly grounded, please contact a qualified electrician.
- Please unplug this chair from the electrical outlet after use and before any cleaning or maintenance. To do so, ensure the main power switch is in the OFF position, then unplug the chair from the outlet.



- This product is intended for use described in this Owner's Manual. Do not use any attachments that are not recommended by the manufacturer.
- Do not use this appliance if the cord or plug is damaged, if it is not working properly, if it has been dropped or damaged, or if it comes into contact with water. In case of any of these scenarios, please call Positive Posture immediately.
- Make sure all air openings are free of lint, hair, or other debris. Do not operate this appliance with the air openings blocked.
- Never use this appliance where aerosol spray products are used or oxygen is being administered.
- Excessive heating of this product can occur and cause fire, electric shock, or serious injury. Do not operate under a blanket, pillow, or heated surface.
- Do not try to move or carry this appliance by pulling or holding onto the power cord.
- Keep power cord away from all heated surfaces.

# CAUTIONS & WARNINGS

---

## Safety During Installation



### TO AVOID ACCIDENT AND INJURY

- Install the chair on a flat and level surface.
- Allow at least 4" (10cm) clearance from the chair's back to a wall to allow sufficient space for reclining up and down.
- Do not drop or slam the foot rest.
- This appliance is not recommended for children under the age of 14. Please keep children away while in use or storage.

### TO AVOID DAMAGE

- Do not use outdoors.
- Stoves, heating products, direct sunlight, or other high temperature areas can cause fading, discoloration, or hardening of the upholstery. Please keep your chair away from this type of exposure.

## Safety Before Use



### PEOPLE NOT SUITABLE TO USE THE CHAIR

- People with circulatory problems (such as varicose veins or thrombosis), children, and those advised not to use a massage chair by their doctor should not use this chair.
- If you have any of the following health conditions, please consult your doctor for medical advice before using this chair: serious heart problems, serious diabetes, serious osteoporosis, serious skin conditions, malignant tumor(s), sensory impairment, pregnancy (or suspected pregnancy) or those who have just given birth, acute gastrointestinal complaints (gastritis, hepatitis, enteritis), joint dysfunction such as rheumatism, hammer toe and gout, thecitis (or suspected thecitis), high fever, spinal abnormalities due to past injury or ailment, curvature of the spine (scoliosis), acute neck sprain (whip lash), or any other medical condition that may contraindicate usage of this product.
- Seek medical advice before using this chair if you have a pacemaker or other electronic medical device, if you have been restricted to bed rest, or if you are planning to use this chair to treat a specific ailment, to recover from surgery, or for therapy.
- Elderly people and those with weak bones should seek medical advice before using this chair even if they do not have a specific disease or disorder mentioned above.
- Do not use this chair if you have recently consumed alcohol.
- This appliance is not intended for use by persons (including children) with reduced physical, sensory or mental capabilities, or lack of experience and knowledge, unless they have been given supervision or instruction concerning use of the appliance by a person responsible for their safety.



## Safety Before Use, continued...



### TO AVOID ACCIDENT, INJURY, AND DAMAGE

- Children should be supervised to ensure that they do not play with the appliance.
- The appliance has a heated surface. Persons sensitive to heat must be careful when using the appliance.
- Do not use this chair for any other reason than described in this manual.
- Do not use this chair with any other therapeutic device or accessory besides those included.
- This chair is intended to be used with all the fabric attached. Failure to do so can result in serious injury.
- Check for any holes or tearing in the active massage area of the chair before each use. If a tear is noticed, stop using immediately and contact Positive Posture.
- Check the position of the roller mechanism prior to sitting down. If the rollers are not in the storage position, turn the power on and check that the chair is operating properly. For the proper storage position, see page 13.
- Do not move the chair while someone is in it.
- Do not stand on this chair.
- Do not sit on any part of the chair other than the seat.
- Do not sit, stand, or lean on the foot rest unless you are sitting in or getting up from the chair.

## Safety During Use



### TO AVOID ACCIDENT AND INJURY

- Do not wrap the power or remote cord around your body or place the chair on top of the cord.
- Do not scratch, tear, treat, twist, stretch, or bend the power or remote cord.
- Spilling water or other liquids on this chair may result in electric shock, short circuit, or combustion.
- Keep all children and pets off the chair and away from the surrounding moving area.
- Do not allow children, invalids, or disabled persons near the chair without close supervision. Keep all persons away from the reclining backrest and extending foot rest to avoid injury.
- Do not use the chair while more than one person is sitting in it, or when holding a baby or small child.
- Do not use the chair if any part of your body, including your hands, is wet.
- Do not use the chair unclothed.
- Do not use this chair for any purpose other than its intended uses outlined in this manual.
- Do not use the chair to massage the head, chest, stomach, and/or joints including knees and elbows.

# CAUTIONS & WARNINGS

---

## Safety During Use, continued...



### TO AVOID ACCIDENT AND INJURY

- Do not place your hands or feet into the roller tracks, or into any moving parts, such as the reclining mechanism.
- Remove all hard objects, such hair accessories or jewelry, before using.
- Do not use the foot rest for anything other than legs or feet.
- Do not operate this massage chair without someone in it.
- Do not put your hands or head between or beneath the leg rest.
- Do not sleep in the chair.
- Never unplug the power cord during operation.
- Upon initial use of this chair, start off with a lighter massage. Starting off with a deep massage may result in injury. Elderly and people with weak bones should be careful while selecting massage intensity.
- If you notice any abnormal condition or in case of an emergency, push the Pause button on the remote to stop operation immediately.
- Immediately discontinue use of the chair and seek medical advice if you notice any acute pain or unusual physical discomfort.
- If the massage feels too strong, reduce the stimulation according to this manual. If it still feels too strong, discontinue use immediately.
- Do not use this chair with the back pad removed.



### TO AVOID DAMAGE

- Do not use this chair if there is a power outage or the possibility of one. In this case, stop using the chair immediately, turn the power switch off, and unplug the cord from the wall outlet.
- Do not use this chair if there is a threat of lightning. If so, stop operation immediately, turn the main power switch off, and unplug the chair from the wall outlet.
- If a specific operation does not start or you find any incidence of abnormality, stop using the chair, turn off the main power switch, and unplug the cord from the wall outlet. Call Positive Posture immediately.

## Safety During Use, continued...



### TO AVOID DAMAGE

- Do not use this chair for any longer than 30 minutes each day. Avoid using a specific focused area massage for more than 5 minutes at a time. Long and continuous massage in the same position may cause discomfort or bodily harm.
- Do not attempt to force your leg, foot, arms, or hands back into the foot rest/armrest if it comes out. Undue force may result in damage to the chair.

### OTHER SAFETY PRECAUTIONS

- Do not cause any major impacts to the chair.
- Do not sit on any part of the chair other than the seat.

## Safety After Use and When Not in Use



### TO AVOID ACCIDENT, INJURY, AND DAMAGE

- Do not plug or unplug the chair with wet hands.
- Do not use any other power cord except the one supplied.
- Grasp the power plug when unplugging the cord from an outlet. Do not use the power cord to pull.
- Turn the main power switch off and unplug the power cord from the wall outlet after each use.
- Always recline the seat back to the upright position after using.
- Wipe down the chair after each use.
- Always store the chair in a low humidity environment.
- Do not place any objects on the chair.
- In case of malfunction, do not attempt to repair. Contact Positive Posture.
- Do not modify any part of the chair.
- Be sure to include this Owner's Manual when transferring this chair to another party.
- Do not dispose of this product or its accessories without consulting with your local authorities beforehand.

# MAIN FEATURES

---

## Intelligent Soft 4D Massage Mechanism

The backrest of your chair is equipped with Positive Posture's 4D technology. Developed based on traditional Chinese massage techniques, the massage mechanism is capable of kneading, tapping, rolling, adjustable speed, and much more.

## L-Track Design

The massage track is designed to mimic the shape of the human body, allowing the mechanism to massage from your neck down to your glutes.

## Acupressure Point Locator Function

Before each massage begins, the chair will scan your back to automatically customize the massage to your specific height and body type.

## Full Body Air Massage Function

Our air massage provides relief to your calves, hips, and outer thighs, as well as the arms, hands, and shoulders.

## Foot Rollers

This chair is equipped with a gentle rolling action to stimulate the soles after a long day. These have been carefully designed to avoid over-stimulating the soles of your feet.

## Calf Shiatsu

Strategically located shiatsu points carefully massage the rear of the calf along the medial line.

## Heat

Relaxing heat can be felt in the rollers, lower back, calves and feet.

## Automatic Reclining Function

To provide individual comfort for any user, the seat back can be reclined up to 160 degrees, while the foot rest can be adjusted up to 80 degrees at the push of a button.

## True Zero Gravity®

Improve blood circulation and alleviate pressure on the joints and spine with the True Zero Gravity position.

## Wall Hugging

Designed to fit almost anywhere, the unique wall hugging technology only requires 4" (10 cm) between the backrest and the wall.

## Stylish Remote Control

Easy to read and easy to use, our remote combines style and functional simplicity.

## Chromotherapy

After selecting a massage your remote screen will begin a color therapy session. A gradual transition between colors will help you relax and melt more deeply into your massage session. (Note: Chromotherapy must be activated within settings.)

## USB Port

USB port allows convenient access to charge your smart phone, tablet or other device while you relax. A port is located on the inside right arm.

# PARTS & FUNCTIONS

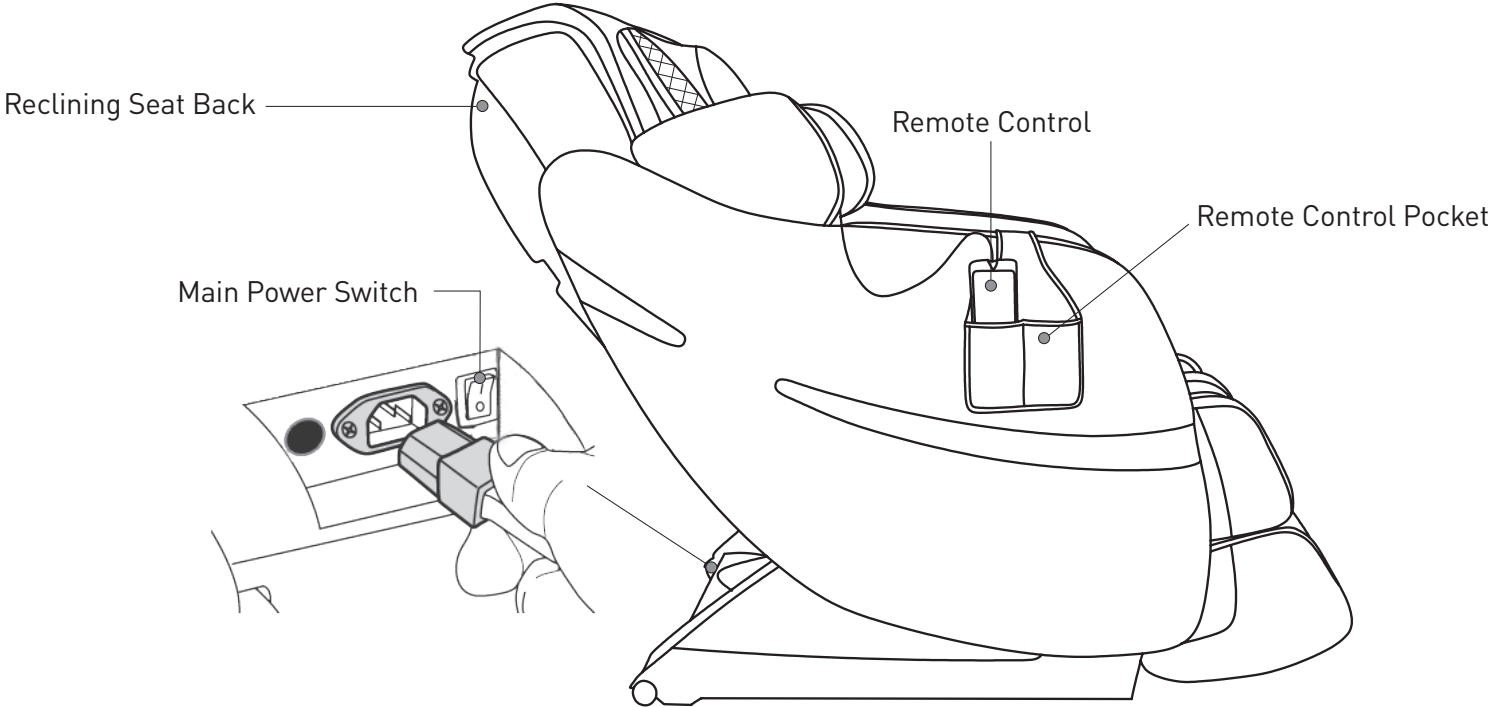
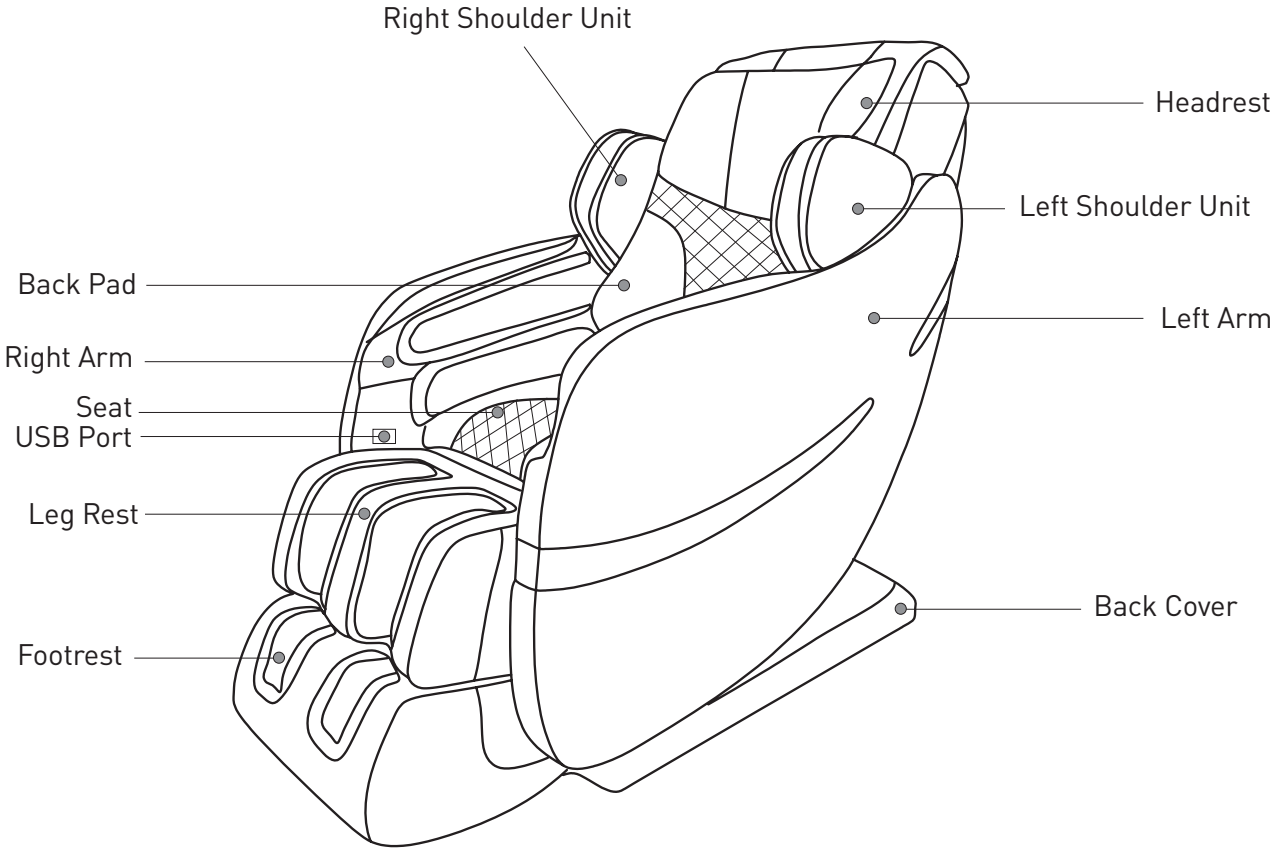

# PARTS & FUNCTIONS

---

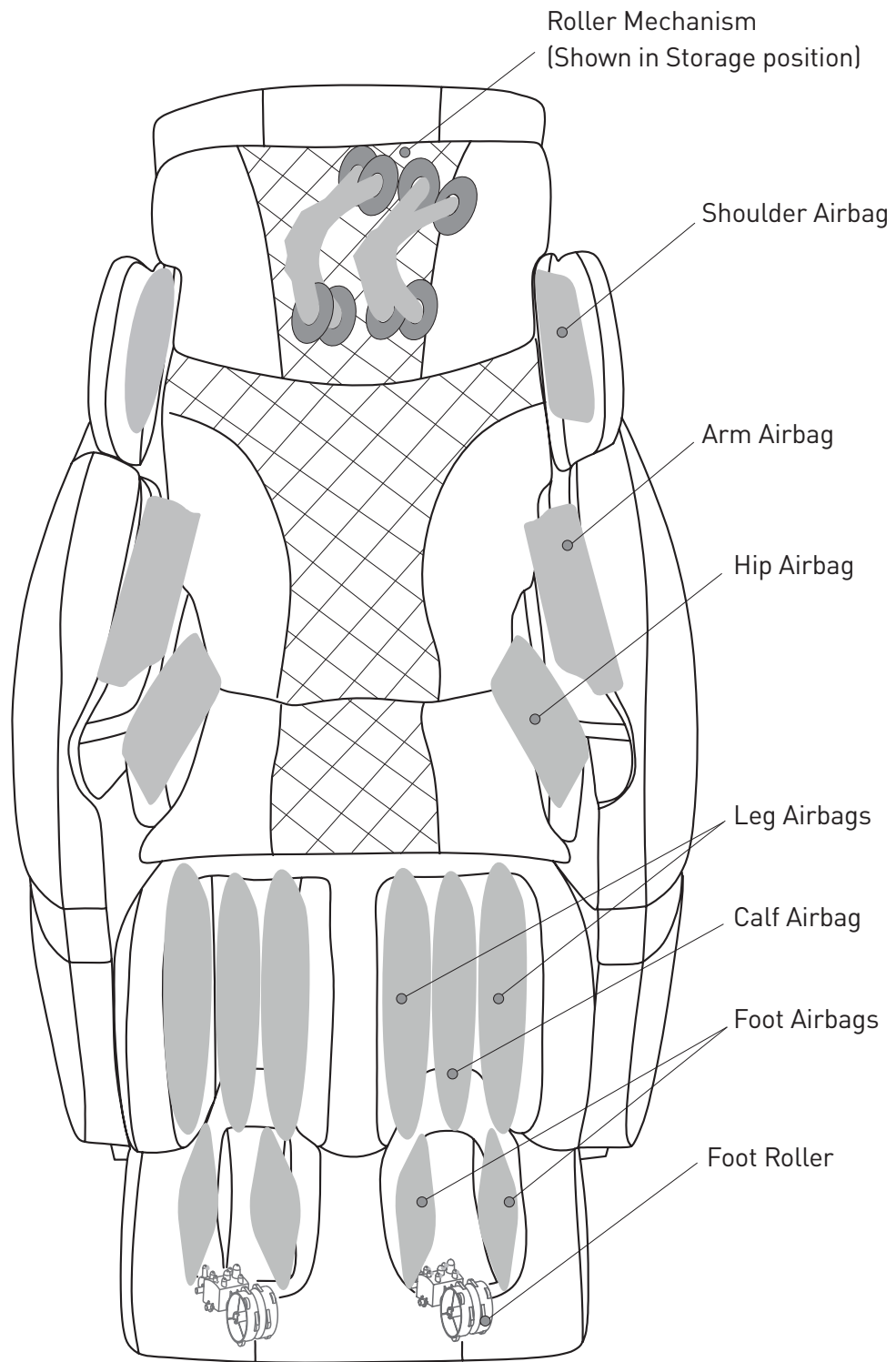

## Safety During Installation



### TO AVOID DAMAGE

- Do not install the chair in an area of high humidity, such as a bathroom or sauna.
- Do not use the chair in an excessively humid or dusty environment as this may result in malfunction or electric shock.
- Do not use the chair in a room with a temperature of 104°F (40°C) or higher.
- Do not expose the chair to heaters, stoves, or direct sunlight.
- Keep fire sources, such as cigarettes and ashtrays, away from the chair.
- Ensure chair is installed on a flat and level surface to avoid tipping over.
- As the chair is heavy, please exercise extra care not to damage the floor when positioning the chair.

## Assembly Preparation

- Ensure there is an allowance of at least 4" (10 cm) behind, and 12" (30 cm) in front of the chair to allow the backrest to recline and the leg rest to extend without obstruction during operation.
- Maintain a minimum distance of 3' (92 cm) from AV devices, such as a TV or radio, to prevent signal interference.
- It is recommended that a carpet be placed under the chair to prevent scratching the floor and to reduce noise during operation.
- As the chair is heavy, please exercise extra caution.

# ASSEMBLY

## Assembling the Chair

Important: Before starting, check the supplied items to ensure all parts are included in the package.

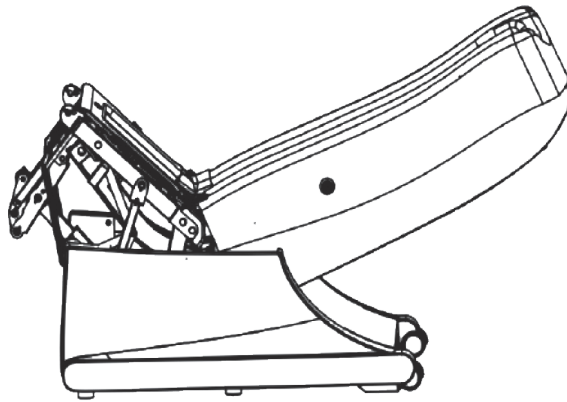

Base

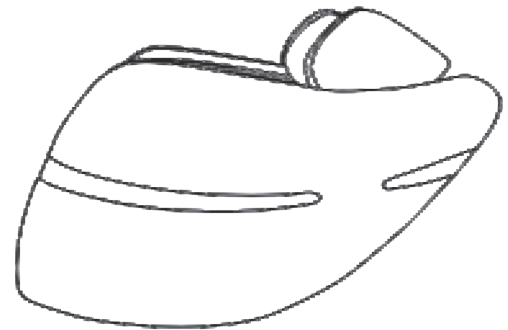

Arm (x2)

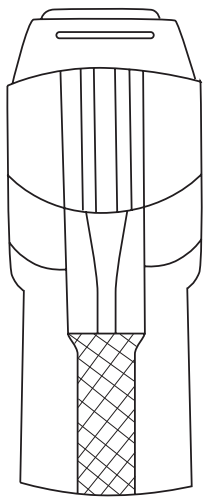

Back/Seat Pad

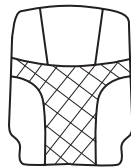

Back Pad Pillow



Carry Handle Bolt (x2)



Screw (x4)

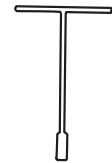

T-wrench

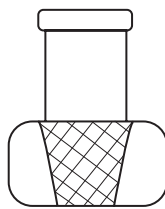

Head Pillow



Carry Handle Tool



Washer (x4)



Power Cord

Included with  
foot rest:

Straight pin  
(x2)

Cotter pin  
(x2)

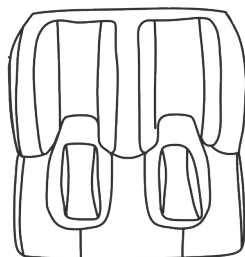

Foot rest

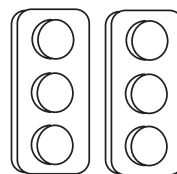

Shiatsu Pads



Remote

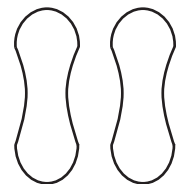

Foot Roller  
Buffer Pads



## Assembling the Chair, continued...



- To prevent disconnection, be sure to double check all connections by gently pulling on the electrical connector and air hose.
- If not connected properly, the air cells will not inflate as designed.

**STEP 1**

Unbox chair and place in designated area.

**STEP 2**

Standing in front of the chair base, locate the seat heat connector found on the right side. Ensure the connector/cord is resting on the seat rather than hanging on the side.

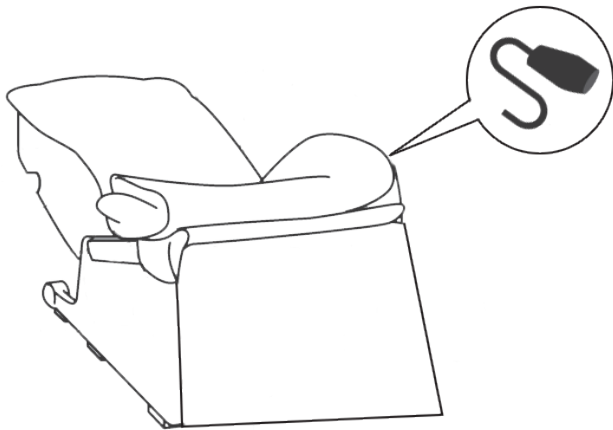
**STEP 3**

Unbox the arms and attach by aligning them to the base of the chair. Once aligned, firmly push arm toward chair base to lock into place.

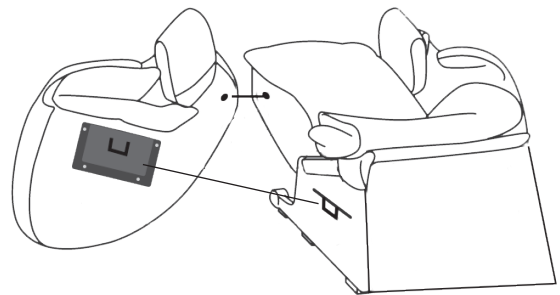

# ASSEMBLY

## Assembling the Chair, continued...

### STEP 4

Connect the airline and electrical connector from each armrest to the base of the chair. (You may need to move hip air bladders toward center of the seat to see connection points on base.)

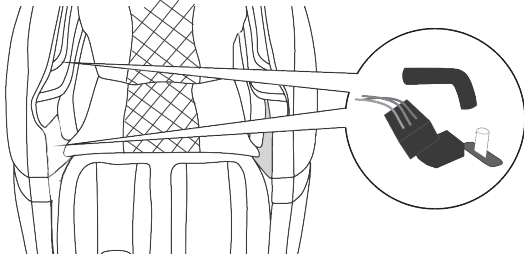

### STEP 5

Secure each armrest to the base of the chair using a bolt, nut, and the provided T-wrench tool. Secure at front and back of each arm. *Note: If screws are installed at an angle, the threads will be ruined.*

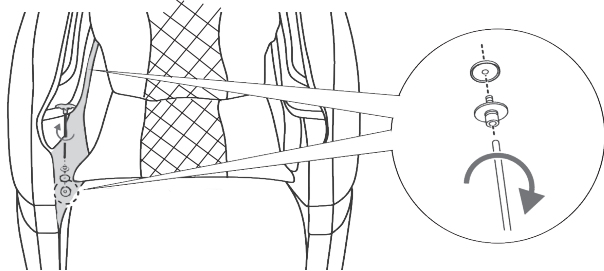

### STEP 6

Set the back/seat pad in place on the chair base. Connect the heat connector on the seat pad to the connector on the base.

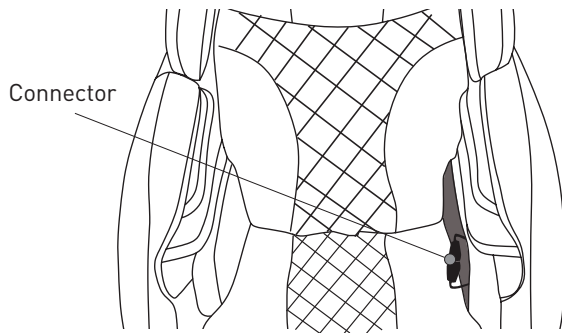

### STEP 7

Secure the back/seat pad in place by zipping the four zippers.

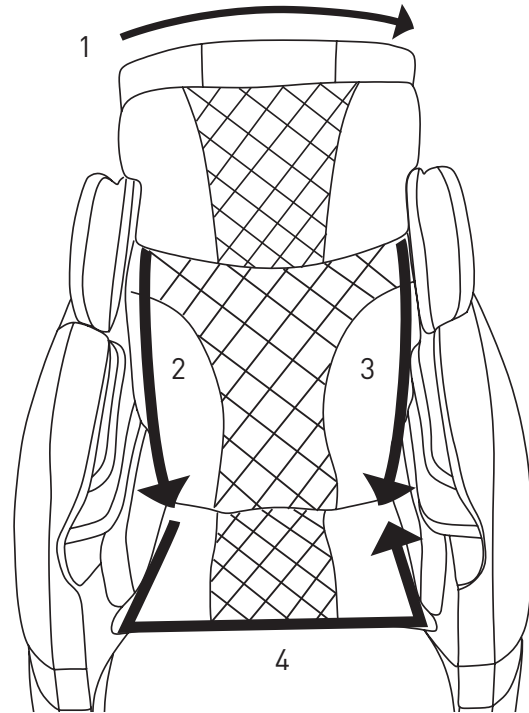

### STEP 8

Attach the head pillow to the back pad pillow by zipping the two together (Figure A), then place onto the chair (Figure B).

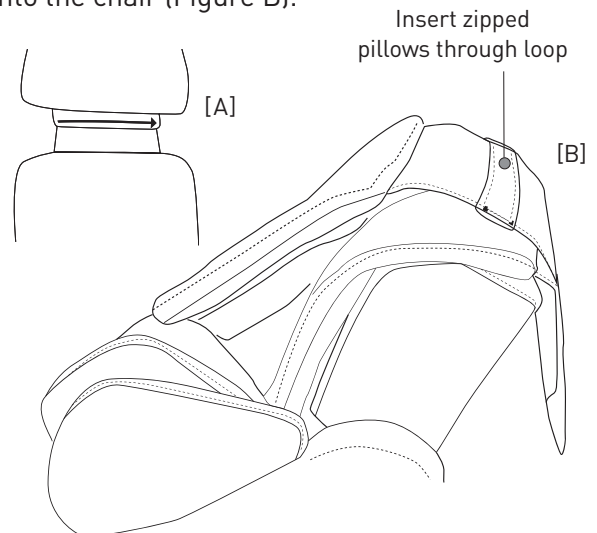

## Assembling the Chair, continued...

### STEP 9

Connect top and bottom zippers of hip air bladders on left and right sides.

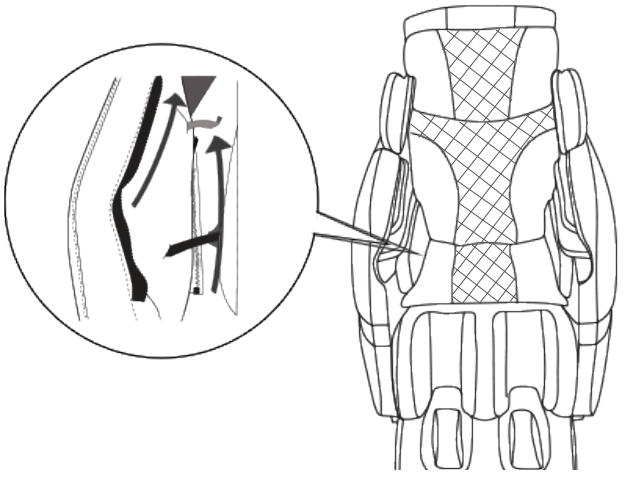

### STEP 12

Before use, insert the remote control into the pocket and manage the remote control cord as shown below. It can be attached to either the left or right side.

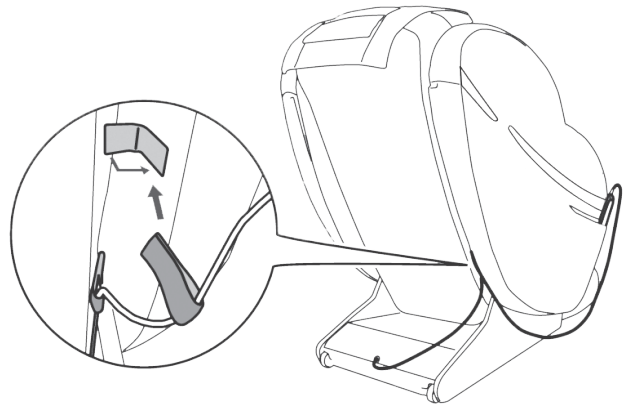

### STEP 10

Plug the power cord into the back base of the chair.

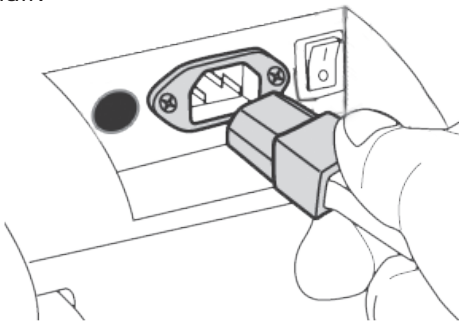

### STEP 13

Turn on the main power.

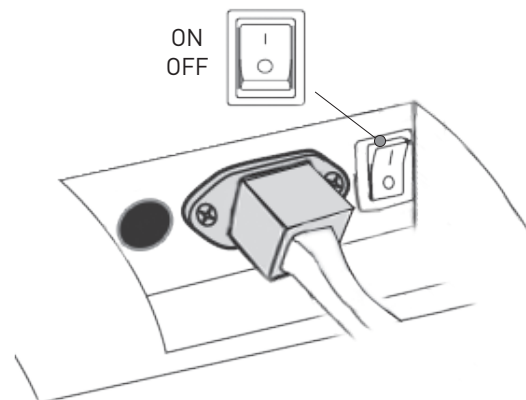

### STEP 11

Screw the remote control connector into the back base of the chair.

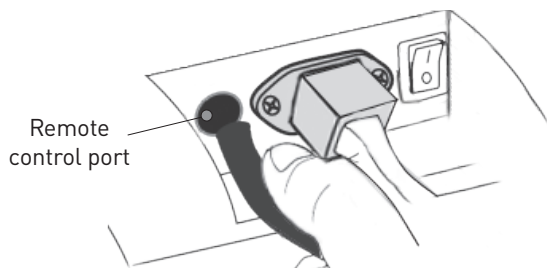

### STEP 14

Using the remote control, power on the chair, then use the Back Up button to bring the chair to its upright position. Again, using the remote control, power off the chair.

# ASSEMBLY

## Assembling the Chair, continued...

### STEP 15

Place the foot rest in front of the chair, then connect the one electrical connector and the three color-coded airlines from the foot rest to the base of the chair. Ensure hose colors match nozzle colors.

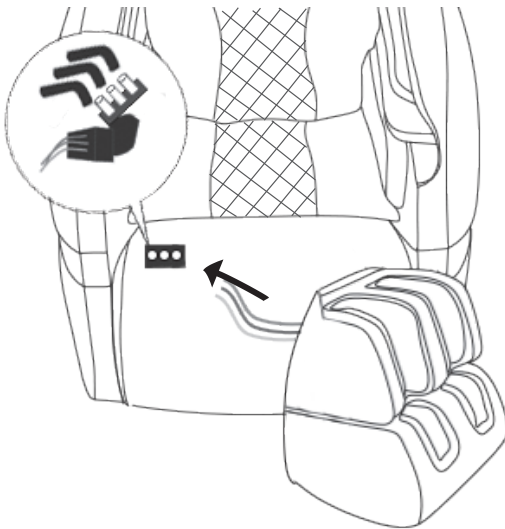

### STEP 17

Zip the seat pan cover to the foot rest.

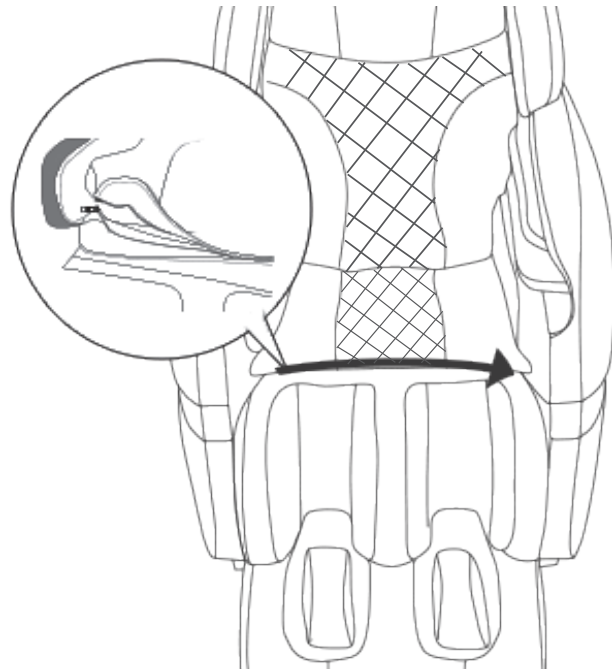

### STEP 16

First remove cotter pin and straight pin from foot rest. Then lift the foot rest so the foot rest connection point aligns with the foot rest brackets on the base. Insert the straight pins through the foot rest brackets, securing with cotter pins.

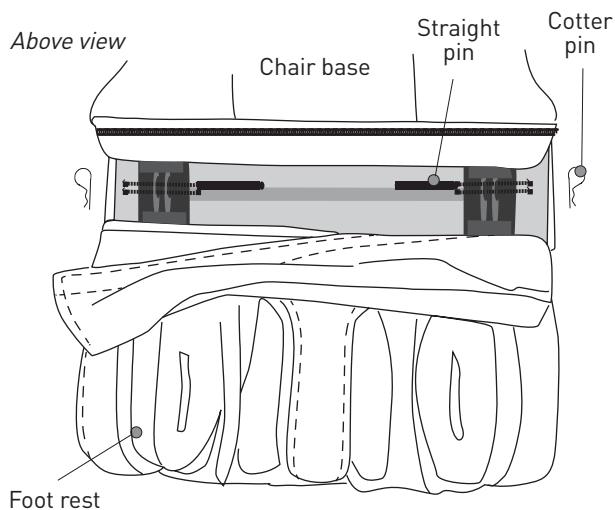

### STEP 18 (OPTIONAL)

Locate the pockets for the Shiatsu Pads and insert. Place foot roller buffer pads on top of foot area. Your chair is ready for use!

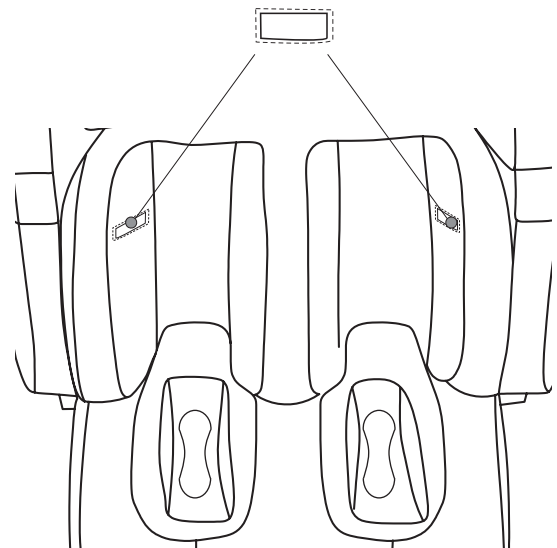

# MOVING THE CHAIR



## TO AVOID DAMAGE

- Never move the chair while it is operating or when someone is in it.
- As the chair is heavy, please exercise extra care not to abruptly drop it. This may cause damage to the floor as well as the internal components of the chair.

Before moving the chair, turn off the main power and disconnect the power plug from the wall outlet. Bind the cables and put them in the seat to avoid damage when moving the chair.



### OPTION 1

Have one person carefully lift the foot rest, while a second person lifts holding the sides of the headrest. Carry to desired location.

Hold the foot rest

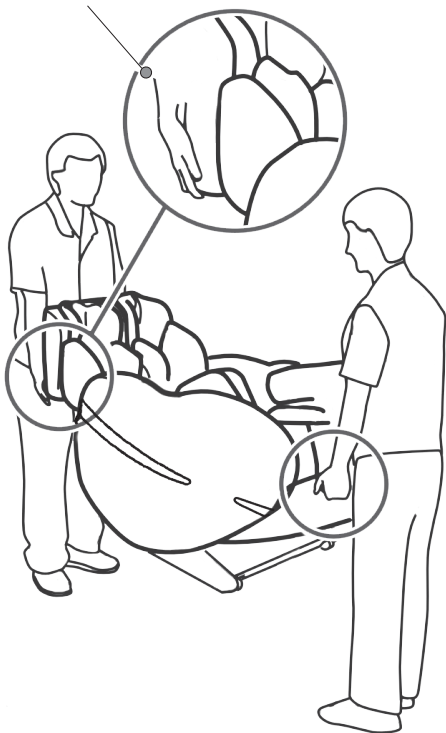

### OPTION 2

- With arms removed, attach the provided carrying handles to the base frame by sliding bolt through hole in the handle and into base as indicated below.
- Using two hands, grab the chair handles and gently lift until the chair is tilted back and resting on the casters located at the opposite end of the base. While the chair is lifted and resting on the casters, roll the chair into the newly desired position.

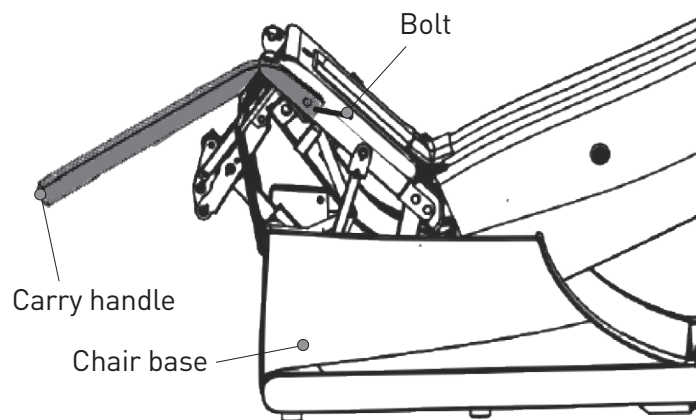

*Attach carry handle as shown; slide bolt through carry handle and into frame.*

# REMOTE FUNCTIONS







## TO AVOID DAMAGE

- Do not sit, step, or place heavy objects on the remote control.
- Do not drop the remote control.
- It is recommended that the remote control be placed in the remote pocket when not in use.
- Do not exert excessive force on the remote control.
- Do not pull the remote control cord forcefully.
- Do not operate the remote control using sharp edged or hard objects.



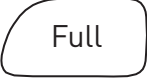
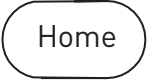
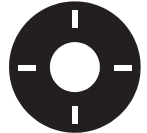

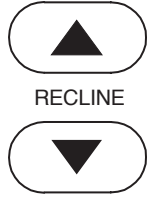



# REMOTE FUNCTIONS

	<ul style="list-style-type: none"> <li>• Press this button to turn the remote control power ON and OFF.</li> <li>• When the power is off, the remote screen is blank and the power button is illuminated in red. When the power is on, the remote screen shows data and the power button is not illuminated.</li> <li>• Pushing the POWER button while the chair is activated causes the rollers to return to their storage position and the chair to sit up, after which the chair turns itself off.</li> </ul>
	<ul style="list-style-type: none"> <li>• Press this button when you want to pause a massage.</li> <li>• During a pause, the pause button will illuminate red.</li> <li>• When the pause button is pressed again, the massage will resume from the point the session was stopped.</li> </ul>
	<ul style="list-style-type: none"> <li>• Press this button to activate the Quick Massage Program. When active, the Quick button will illuminate in blue.</li> </ul>
	<ul style="list-style-type: none"> <li>• Press this button to activate the Full Body Massage Program. When active, the Full Body button will illuminate in blue.</li> </ul>
	<ul style="list-style-type: none"> <li>• Press this button to activate the menu on the LCD Screen where you can select manual and massage sessions, adjust massage intensity, roller width, speed, and more.</li> <li>• Press this button again to return to the home screen.</li> </ul>
	<ul style="list-style-type: none"> <li>• Use the arrows to navigate through the menu(s) on the LCD screen (up, down, left, right).</li> </ul>
	<ul style="list-style-type: none"> <li>• After navigating to the desired selection within the LCD menu, press this button to select/activate the option.</li> </ul>
	<ul style="list-style-type: none"> <li>• Press these buttons to adjust the reclining angle of the chair.</li> <li>• To automatically incline or recline the back to its fully extended or upright position, press and hold the corresponding Recline button for approximately 2 seconds.</li> <li>• Press again to stop the chair while automatically reclining.</li> </ul>

# REMOTE FUNCTIONS

---

## Remote Functions, continued...

 <p>LEG REST</p> 	<ul style="list-style-type: none"><li>• Press these buttons to adjust the angle of the foot rest.</li><li>• To automatically raise or lower the foot rest, press and hold the corresponding foot button for approximately 2 seconds.</li><li>• Press again to stop the chair while automatically adjusting.</li></ul>
 <p>ROLLERS</p> 	<ul style="list-style-type: none"><li>• Press these buttons to adjust the roller's position during a manual massage or to perfect the shoulder scan position.</li></ul>
	<ul style="list-style-type: none"><li>• Press this button to turn the heat on and off in the lower back, calves, and feet.</li><li>• When the heat is on, the heat button will illuminate red.</li><li>• NOTE: The heat will automatically shut off after 20 minutes.</li></ul>
	<ul style="list-style-type: none"><li>• Press this button to change the intensity of the roller massage which can be adjusted in five varying intensities.</li></ul>
	<ul style="list-style-type: none"><li>• Press this button to manually turn on and off the foot rollers.</li><li>• When the foot roller is active, the foot roller button will illuminate blue.</li></ul>





## Programmed Sessions

This chair has a total of ten programmed massage sessions from which you can choose. These provide easy-to-use massage options optimized to meet your needs. Each of the below sessions (excluding the Quick session) lasts approximately 15 minutes and can be selected by navigating through the menus on the LCD screen unless otherwise noted.

### Quick

Incorporates massage, air, and foot rollers. It is designed to quickly refresh the entire body. Select by pressing the Quick Session button. Session lasts approximately 8 minutes.

### Full Body

A comprehensive, full body massage program rejuvenates your entire body and your mind. Select by pressing the Full Body Session button.

### Refresh

Recommended for use just after waking up in the morning or after a nap. It will encourage blood flow from your extremities toward the core of your body, while waking you up and preparing your body and mind for the day ahead.

### Relax

Full body session recommended for use just before bed to clear the mind and meditate. It is choreographed to move blood from the core of your body toward your extremities, relaxing you and quieting your body for sleep or meditation.

### Meditate

Full body massage designed to help relax the body and quiet the mind. It is designed around gentle, repetitive, and hypnotic motions.

### Stretch

Offers numerous carefully crafted stretching movements including hip rotation and back extension. Designed to help stretch and loosen the muscles of the entire body.

### Neck & Shoulders

Focused kneading massage around the neck and shoulders designed to help loosen the muscles of the upper back.

### Low Back

Performs focused tapping and kneading massage to soothe and loosen the muscles around the lower back and hip areas.

### Feet & Calves

Relieves sore and achy feet and legs. Excellent for people who have been on their feet all day.

### Full Body Air Massage Function

Full body air massage around your arms, shoulder, hips, legs, and feet. A gentle and soothing massage with no percussion movements at all.

# OPERATION & USE



## TO AVOID INJURY

Always check your surroundings before beginning a massage to ensure that no people, pets, or objects will be hit or squeezed by the reclining back or footrest.



## TO AVOID DAMAGE AND INJURY

- This massage chair is meant to be used for indoor household use only. The chair is not designed for commercial purposes.
- If you use the chair in a cold room, do not increase the temperature abruptly. Instead, increase the temperature gradually to a normal level.
- If the chair is stored in a cold place and is moved into a warm environment, wait one hour before use. Otherwise, performance may suffer, or the chair may malfunction due to condensation on the mechanism.
- Do not sit on the chair with the leg rest raised. Sudden heavy weight on the leg rest could cause damage to the mechanism, or it may result in accident or injury.
- Ensure the backrest returns to the upright position before sitting.
- Do not use the arm or shoulder unit for any area other than your arms and shoulders.
- If your arm comes out of the arm or shoulder unit or your leg/foot come out of the foot rest during a massage, do not try to force it back in.
- Do not massage your elbows.
- Do not put anything other than legs and feet in or on the foot rest.

## Positioning Yourself in the Chair

- When the chair is off, the rollers are stored in the top of the backrest. This is known as the storage position. If the rollers are not in the storage position, simply reset by pressing the Power button on the remote control before sitting on the chair.
- Adjust the headrest so it sits just above your shoulders and at the base of your neck.
- Before starting a massage, sit back fully in the chair so your entire back is resting against the backrest and your head is leaning on the pillow.

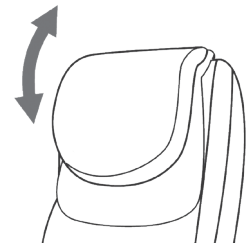

### SMALL HEADREST POSITIONING

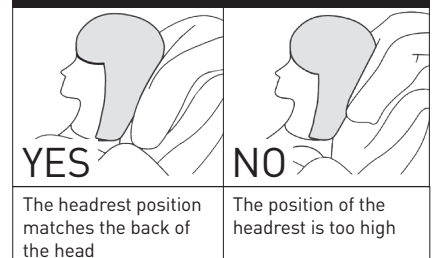

## Positioning Yourself in the Chair, continued...

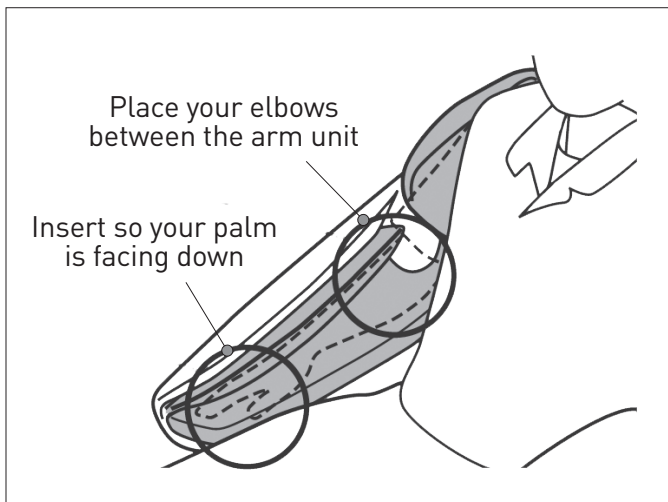

Place your arms in the arm unit, palms down.

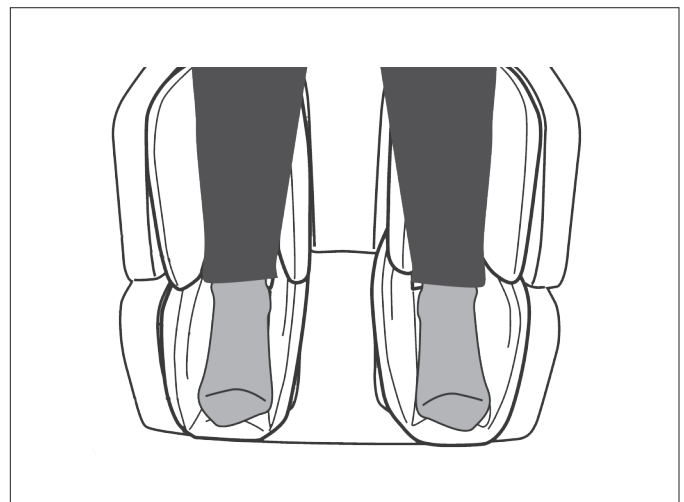

Place your legs and feet in the leg rest.

*Note: When the foot rest raises, press out with your feet and the foot rest will adjust to the appropriate length (see below).*

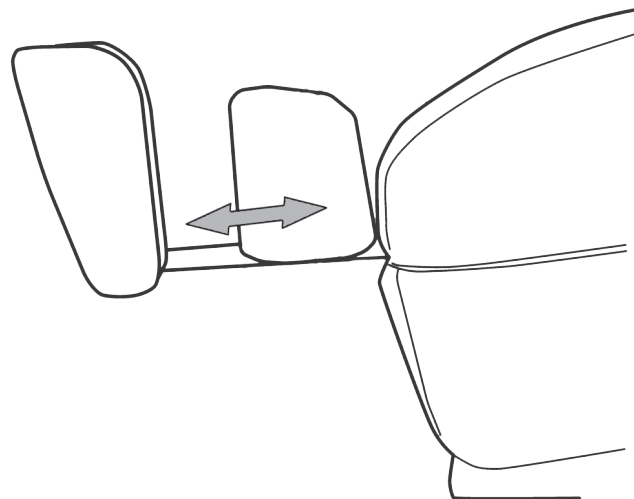

# OPERATION & USE

---



## TO AVOID INJURY

- If you feel the massage is too strong, reduce the stimulation using the Massage Intensity button as described earlier in this manual. If the massage remains too strong, stop operation immediately.
- Do not place hands or feet into the roller tracks, into the space between the seat and back, or into the moving parts.
- Do not sit wearing hard objects, such as hair accessories or jewelry.
- Keep massage sessions to no more than 30 minutes in length. Do not exceed 5 minutes for an area-specific massage for any part of the body.

## Powering On

- Press the Power button to turn the remote control power ON. When the power is ON, the remote screen shows data on the main menu and the Power button is not illuminated.

## Powering Off

- Press and hold the Power button for 2 seconds to turn the remote control power OFF. When powering off, the power button will flash red until the chair is fully reset. Once complete the power is OFF, the remote screen will be black/blank, and the Power button will glow red.
- If the chair has been in a reclined position it will automatically restore to the upright position when powered off.

*Note: The remote power will automatically turn off after approximately 15 minutes of inactivity.*

*Note: The Power button on the remote is not the Main Power switch. See page 13 for Main Power Switch location.*

## Starting a Massage & Accupressure Point Detection

- Use the remote to select the programmed, manual, or air massage session you desire.
- To experience the perfect massage for your body, adjust the headrest so it sits just above your shoulders and at the base of your neck. Then sit back fully in the chair so your entire back is resting against the backrest and your head is leaning on the pillow.
- After a massage is selected, the chair will automatically detect your acupressure points by running the rollers down and up your back.
- Once the acupressure detection has completed, the selected massage session will automatically begin.

*Note: Acupressure point detection will not activate with air massages or manual massages.*

*Note: Acupressure point detection only happens upon first massage when powered on. Memory settings keep this data for all massages after.*

## Accupressure Point Detection

To experience a massage as intended, it is extremely important to define the shoulder position prior to the start of a massage session.

- **Fine Tune Shoulder Position:** Once Auto-Detect is complete, the remote will beep, the roller buttons glow blue, and the help text “Fine tune shoulder position now” appears at the bottom of the screen. Roller position can be adjusted by pressing and holding the Roller Up or Down arrows until the mechanism is located in the proper position at the tops of the shoulder.
- The chair will remember your body profile for all massages performed during the same power cycle. The chair will only scan once while powered on, upon the first Programmed massage selection. If a second program is selected the scan from the first program is remembered and used for the new selection. Anytime a new user enters the chair, the remote, if it has been left on from a previous user, should be powered off and back on to ensure that the new user is properly scanned.

*Note: Fine Tune Shoulder Position lasts approximately 15 seconds before the shoulder position is stored and used for all massage choreography.*

*Note: Accupressure point detection does not occur when selecting Manual or Manual Air massages.*

## Stopping or Pausing a Massage

- If the Pause Button is pressed, all of the massage movements will pause. To restart the massage, press the Pause button again.
- To stop in the middle of a massage, press the Power button. The rollers will return to their storage position (upper part of the seat back), and the chair will automatically incline to its upright position.



# OPERATION & USE

---

To navigate through the menu options, use the right/left/up/down arrows surrounding the OK key.  
To select an option, press OK.

## Selecting an Auto Program

- When **Programs** is highlighted, use the right arrow to hover over the list of programmed massage sessions. Then use the down/up arrow until the program you would like to experience is highlighted. Press OK and the session will begin. A red dot next to the program name will indicate your active selection.

*All sessions do not appear on one screen as shown to the right. Use the down/up arrow to continually scroll through all session options.*



## Selecting a Manual Session

- When **Manual** is highlighted, use the right arrow to hover over the list of manual options. Then use the down/up arrow until the option you would like to experience is highlighted. Press OK and the session will begin.
- Manual sessions may be combined with a manual air session. A red dot next to the program name will indicate your active selection.
- Only one manual massage session can run at any given time.

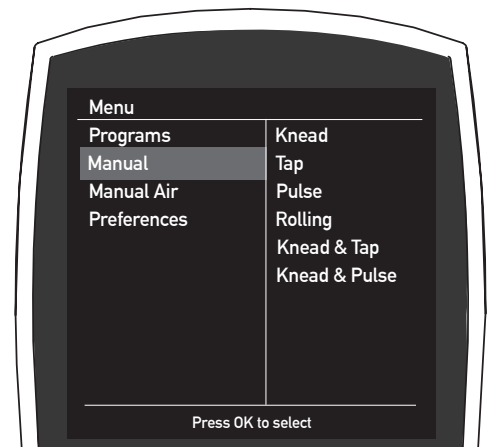

## Selecting an Air Massage

- When **Manual Air** is highlighted, use the right arrow to hover over the list of massage options. Then use the down/up arrow until the program you would like to experience is highlighted. Press OK and the session will begin. A red dot next to the program name will indicate your active selection.
- An air program may be combined with a manual session.
- Only one air massage program can run at any given time.

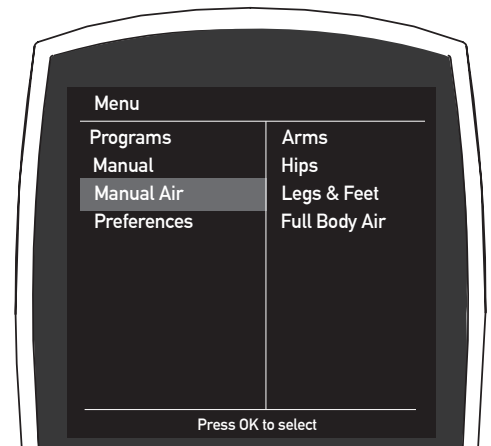

## Massage Mechanism Intensity Adjustment

*Feature available on Programmed (excluding Full Body Air), and Manual massages*

The degree of pressure felt from the massage mechanism, can be adjusted between Soft (1) and Firm (5) by pressing the 3D button on the remote or by adjusting intensity within the menu settings of the selected massage. The default setting is medium.

*Using the 3D button on the remote...*

- Press and release the button once to go from intensity level 3 to intensity level 4, and so on. Repeat as desired. When at intensity level 5 (Firm), another press of the 3D button will return the user to intensity level 1 (Soft).

*Using the menu settings of the selected massage...*

- If not already there, press Home/Menu to access the Main Menu. Use the navigation arrows, located in the center of the remote, to navigate to the active program, then use the right arrow to navigate to the 3D intensity adjustments. Once the desired intensity level is highlighted, press OK to select. A red dot next to the intensity level will indicate your active selection.

## Massage Mechanism Speed Adjustment

*Feature available for all Manual methods.*

Speed, or the pace at which the massaging movements of the massage mechanism occur, can be adjusted between Ultra Slow (1) and Fast (5) by adjusting speed within the menu settings of the selected massage. The default setting is 3.

*To adjust Speed using the menu settings of the selected massage...*

- If not already there, press Home/Menu to access the Main Menu. Use the navigation arrows, located in the center of the remote, to navigate to the active program, then use the right arrow to scroll to Speed adjustments. Once the desired speed is highlighted, press OK to select. A red dot next to the speed option will indicate your active selection.

## Width Adjustment

*Feature available for the following Manual methods: Rolling, Pulse, Tap*

Width, or the distance between the rollers on the massage mechanism, can be adjusted between Narrow, Middle and Wide within the menu settings of the selected massage. Note the default setting is Middle.

*To adjust Width using the menu settings of the selected massage...*

- If not already there, press Home/Menu to access the Main Menu. Use the navigation arrows, located in the center of the remote, to navigate to the active program, then use the right arrow to scroll to Width adjustments. Once the desired width is highlighted, press OK to select. A red dot next to the width option will indicate your active selection.

# OPERATIONS & USE

---

## Coverage Adjustment

*Feature available for all Manual methods.*

Coverage, or the area of the body that is massaged, can be adjusted between Partial Back (massages a small area approximately 6" (15.25 cm) in length) and Full Body (massages the length of the entire track) within the menu settings of the selected massage. Note the default setting for Coverage is Partial Back.

*To adjust Coverage using the menu settings of the selected massage...*

- If not already there, press Home/Menu to access the Main Menu. Use the navigation arrows, located in the center of the remote, to navigate to the active program, then use the right arrow to scroll to Coverage adjustments. Once the desired area is highlighted, press OK to select. A red dot next to the coverage option will indicate your active selection.
- When coverage selection is Partial Back, the up/down Roller buttons will adjust the area massage. To massage an area closer to the shoulder, press the Roller Up arrow. To massage an area close to the glutes press the Roller Down arrow.

## Combining Manual & Manual Air Massages

- A Manual massage method may be combined with an air massage.
- To activate air massage with a manual massage, if not already there, press Home/Menu to access the Main Menu. Use the navigation arrows, located in the center of the remote, to scroll to the desired Manual Massage, press OK to select. Then use the navigation arrows to scroll to the desired Manual Air Massage, press OK to select.

## Heat

- The chair is equipped with heat in the rollers, lower back, calves & feet. Heat can be enjoyed on its own, or during any massage session.
- To turn heat on, press the Heat button on the remote. When heat is on, the button will illuminate red.
- To turn off heat, press the Heat button a second time. When heat is off, the button will not be illuminated.
- If heat is desired only in select zones, this can be adjusted by, if not already there, pressing Home/Menu to access the Main Menu. Use the navigation arrows, located in the center of the remote to scroll to preferences, then scroll right to Heat settings, then press OK. Use the navigation arrows highlight the zones which you'd like to deactivate/activate. Press OK to change from Enabled (ON) to Disabled (OFF), and back again.

## Foot Rollers

- The chair is equipped with foot rollers which can be enjoyed on their own, or during any massage session.
- To turn Foot Rollers on, press the Foot Roller button on the remote. When foot rollers are on, the button will illuminate blue.
- To turn Foot Rollers off, press the Foot Roller button a second time. When the Foot Rollers are off the button will not be illuminated.

*Note: Foot Rollers automatically turn on with all programs excluding Stretch and Full Body Air.*



## Pausing a Massage

- To pause a massage, press and release the Pause button. Upon doing this, the massage mechanism will immediately cease all movement, the chair angle will remain in the exact position it was when the button was pressed, and the Power/Pause button will illuminate red.
- To resume the massage, quickly press and release the Pause button again. Upon doing this the Pause button will no longer illuminate, and the massage will resume from where it was stopped.

## Ending a Massage

- To end a massage in the middle of an active session, press and hold the Pause button for 2 seconds. This action will end the session by powering off the chair. The massage mechanism will slowly move to its storage position (upper shoulders) and, if the chair has been in a reclined position, it will automatically incline to the upright position. *Please remain in the chair until it has come completely upright. This will take no more than 1 minute.*

*NOTE: Massages will automatically stop after approximately 15 minutes of activity. The chair will remain reclined.*

*NOTE: Never get out of the chair without first returning it to its full upright position.*

*NOTE: Never press on shoulders or stand on foot rest to get out of chair.*

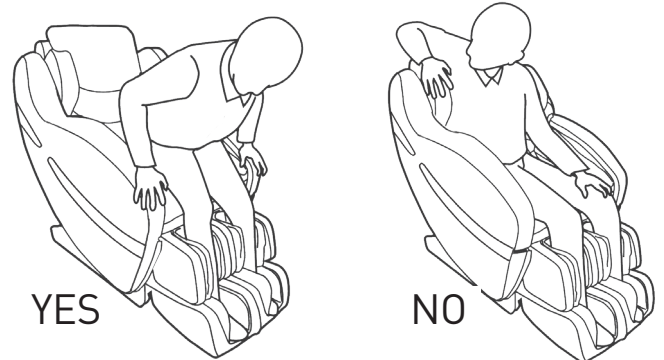

## Removable Foot Buffer Pads

- The chair comes with Foot Buffer pads in the accessory box. The foot buffer pads should be placed in the foot beds if the user finds the foot roller massage too intense.

## Sound

- The remote can be set up to either beep or remain silent with each button press. To change the Sound setting, if not already there, press the Home/Menu button to access to the Main Menu. Then use the navigation arrows to navigate to Preferences, scroll right to access Sound, press OK to turn the Sound ON. Press again to turn the Sound OFF.

*NOTE: The default setting is Sound Off.*

## Chromotherapy

- For additional sensory relaxation, the remote is programmed to be able to display chromotherapy sessions when powered on and the remote has been idle for 90 seconds.
- To change the Chromotherapy setting, if not already there, press the Home/Menu button to access to the Main Menu. Then use the navigation arrows to navigate to Preferences, scroll right to access Chromotherapy modes. Once desired setting is highlighted, press OK to preview and select. A red dot will appear to the right of the selected mode.

*NOTE: The default mode is Off.*



# OPERATIONS & USE

---

## About

Service contact information, as well as data about the chair which may be helpful when calling for service is located within the About menu. To view this information, if not already there, press the Home/Menu button to access to the Main Menu. Then use the navigation arrows to navigate to Preferences, scroll right to access the About menu.

## Reading the Remote Home Screen

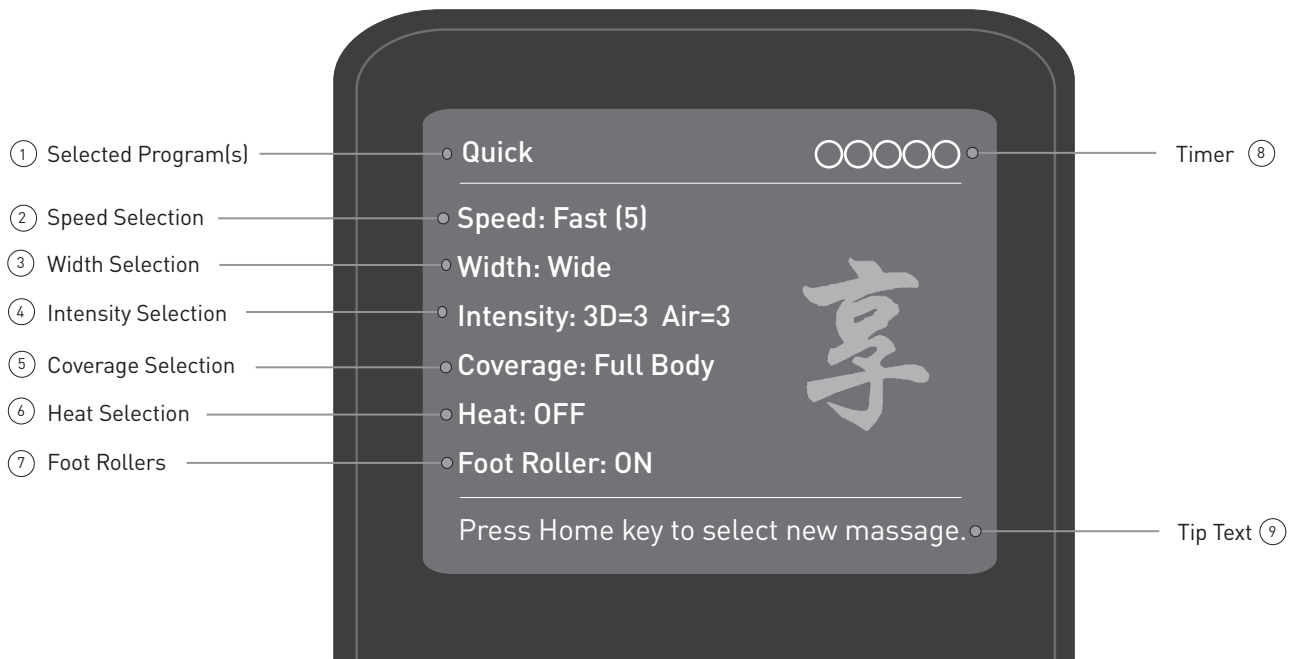

- ① The selected program(s) names will appear here.
- ② The information after the colon indicates your speed selection.
- ③ The information after the colon indicates your width selection.
- ④ The information after the colon indicates your intensity selections. The number shown after "3D=" is your mechanical intensity selection. The number shown after "Air=" is your air intensity selection.
- ⑤ The darkened word indicates your coverage selection.
- ⑥ The information after the colon indicates if heat is on or off.
- ⑦ The information after the colon indicates when the foot rollers are on or off.
- ⑧ Over the course of a program the circles will slowly fill indicating progress of the program. When all 5 circles are filled the program is nearly complete.
- ⑨ Scrolling tip text helps guide you through the massage chair usage.

## Storage

- After every use, turn off the main power switch located on the back of the chair and unplug the power cord from the wall outlet.
- When not in use, the chair should always be stored in its full upright position (backrest fully inclined, foot rest to its lowest position).
- The chair should be stored in a place of low humidity.
- Do not store the chair in direct sunlight or in places of high temperature. This may cause the color of the upholstery to fade.

## Cleaning & Care

 WARNING
<b>TO AVOID INJURY</b>
<ul style="list-style-type: none"><li>• Before cleaning, always unplug the power cord from the wall outlet.</li><li>• Never clean the chair or remote with wet hands.</li></ul>

 CAUTION
<b>TO AVOID DAMAGE</b>
<ul style="list-style-type: none"><li>• Before cleaning, always unplug the power cord from the wall outlet.</li><li>• Never clean the chair or remote with wet hands.</li></ul>

- Use a soft, dry clean cloth to wipe dust off of upholstered surfaces and the remote control.
- For spots on the fabric, dampen a soft, clean cloth with warm water and a mild detergent, then gently rub. Finish with a soft, dry clean cloth.



# TROUBLESHOOTING

---

## Troubleshooting Guide

If you encounter problems with the operation of your massage chair, please check the following points to see if they can be easily rectified. If the chair still malfunctions or does not work, please turn off the main power switch and remove the power plug from the wall outlet.

Contact Positive Posture for service. Do not dismantle or attempt to repair the chair yourself. Doing so will void the warranty.

**Problem: My chair doesn't work after powering on.**

**Possible Cause & Solution:**

- Ensure the chair is securely plugged into a working wall outlet.
- Ensure the main power switch on the back of the chair is switched to the ON position.
- Ensure the remote control and power cord are fully installed.
- Ensure the remote power is on by pressing the Power button on the remote.
- Ensure a massage session has been selected by pressing any programmed or manual massage button on the remote.
- Other issues may include the wires or plug being damaged, the fuse having burned out, or an issue with the inner circuit. Call Positive Posture for service.

**Problem: My chair makes a beeping sound during the massage.**

**Possible Cause & Solution:**

- This sound is normal during the shoulder scan. There is no cause for concern.

**Problem: My chair is very noisy.**

**Possible Cause & Solution:**

- There are many sounds made by the massage chair that are normal. This includes noise during tapping, the sound of the rollers rubbing against the seat covering while kneading, the sound of the rollers moving up and down the track, and the sound of the air pump and the air bags inflating and deflating. If you are hearing sounds other than this, or the sounds suddenly become different/louder, please call Positive Posture for service.

**Problem: The left and right rollers are out of alignment.**

**Possible Cause & Solution:**

- The rollers are designed to work independently, so in the stopped position they are sometimes out of line. This is part of the design and is normal.

## Troubleshooting Guide, continued...

**Problem: The rollers suddenly stopped in the middle of a session.**

**Possible Cause & Solution:**

- The chair may have lost power. Turn off the main power switch, unplug from the wall, then reinsert the power cord into the wall outlet and turn on the main power switch.
- Ensure the massage session didn't complete its cycle by using the remote to select a new massage session, programmed, or manual massage button on the remote.
- Sometimes when there is too much pressure on the rollers, they can stop moving temporarily. To test this, slightly lift your body or slightly raise the reclining seat back.

**Problem: The backrest or leg rest will not go down entirely.**

**Possible Cause & Solution:**

- Ensure there are not any objects blocking its path.

**Problem: The acupressure point detection is not working properly.**

**Possible Cause & Solution:**

- Try sitting further back in the chair so that your head rests firmly on the headrest. You can also adjust the shoulder position with the Roller buttons immediately after the acupressure point detection is complete.

**Problem: The power cord or plug is abnormally hot.**

**Possible Cause & Solution:**

- Stop using the chair immediately. Turn off the main power switch and remove the power plug from the wall outlet. Call Positive Posture for service.

## Frequently Asked Questions

**Q: Can I put the chair on a wood floor?**

**A:** Yes. However, because the chair could damage the floor surface we recommend laying a carpet or something similar under the chair.

**Q: I spilled water on the chair. What should I do?**

**A:** There is danger of electric shock. Immediately stop using the chair and do the following:

- Turn off the main power switch on the back of the chair.
- Unplug the power from the wall outlet.
- Contact Positive Posture for assistance.

**Q: How do I make the massage stronger?**

**A:** Try any of the following things:

- Use the 3D button to select maximum pressure.
- Sit back further in the chair so that your weight is against the reclining seat back.
- Lower the reclining seat back.

**Q: How do I make the massage lighter?**

**A:** Try any of the following things:

- Use the 3D button to select minimum pressure.
- Raise the reclining seat back.

# WARRANTY & AFTER SALES SERVICE

---

## Warranty

For warranty information please visit our website at [www.positiveposture.com/pages/warranty-support](http://www.positiveposture.com/pages/warranty-support). We recommend that you print this information at the time of purchase and keep it with your Owner's Manual.

## Service & Repairs

Before calling for repairs or service, review the Troubleshooting Guide on page 35 to see if the problem can be easily resolved. If the problem persists, contact Positive Posture for assistance by phone or email [service@positiveposture.com](mailto:service@positiveposture.com). Please have the following information ready:

- Your name, address, and telephone number
- Model Number (see the specification field on the front cover of this Owner's Manual or review the sticker affixed the back left of the base of your chair)
- Serial Number (see the sticker affixed to the back left of the base of your chair)
- Purchase date
- Malfunction condition (give as much detail as possible)
- Copy of original receipt

*Note: We will stock service parts (except fabric) for this massage chair for a minimum of five (5) years after terminating production of the model. The service parts are those necessary to maintain the function of the chair.*



# SPECIFICATIONS

---

Model Name	Brio+
Model Number	PP7913E
Power Supply	AC120V ~ 60Hz
Power Consumption	200W
Rated Time	30 minutes
Kneading Speed	From 17 times/minute to 38 times/minute
Tapping Speed	From 17 times/minute to 38 times/minute
Up/Down Speed	From 1 time/minute to maximum 18 times/minute
Back Stroke Range	47" (120 cm)
Preset Sessions	10 Sessions
Manual Sessions	9 Sessions
Air Pressure	Approximately 37 kPa
Program Timer	Approximately 15 minutes
Foot Rest Adjustment Range	Approximately 12.6" (32 cm)
Reclining Angle	Approximately 123 degrees to 157 degrees against flat floor
Chair Dimensions	59" (150 cm) L x 33.5" (85 cm) W x 48.4" (123 cm) H
Seat Width	18" (46 cm)
Seat Depth	18" (46 cm)
Chair Weight	251 lbs (114 kg)
Outer Cover	Synthetic Leather
Supplied Items	Power cord, T-shaped wrench, screws
Shipping Dimensions	Box 1: 60" (151 cm) x 30" (76 cm) x 33" (83 cm) Box 2: 57" (145 cm) x 21" (53.5 cm) x 35" (87 cm)
Shipping Weight	Box 1: 196 lbs (89 kg), Box 2: 121 lbs (55 kg)
Recommended User Weight	265 lbs (120 kg) (maximum)





# POSITIVE POSTURE®

---

Brio+ was meticulously designed to conform to your specific comfort and relaxation needs. If you have any questions at all about the operation of your massage chair, please contact a Positive Posture chair expert by phone or [service@positiveposture.com](mailto:service@positiveposture.com).

---