

ZOOMER™

LITE

PRODUCT MANUAL

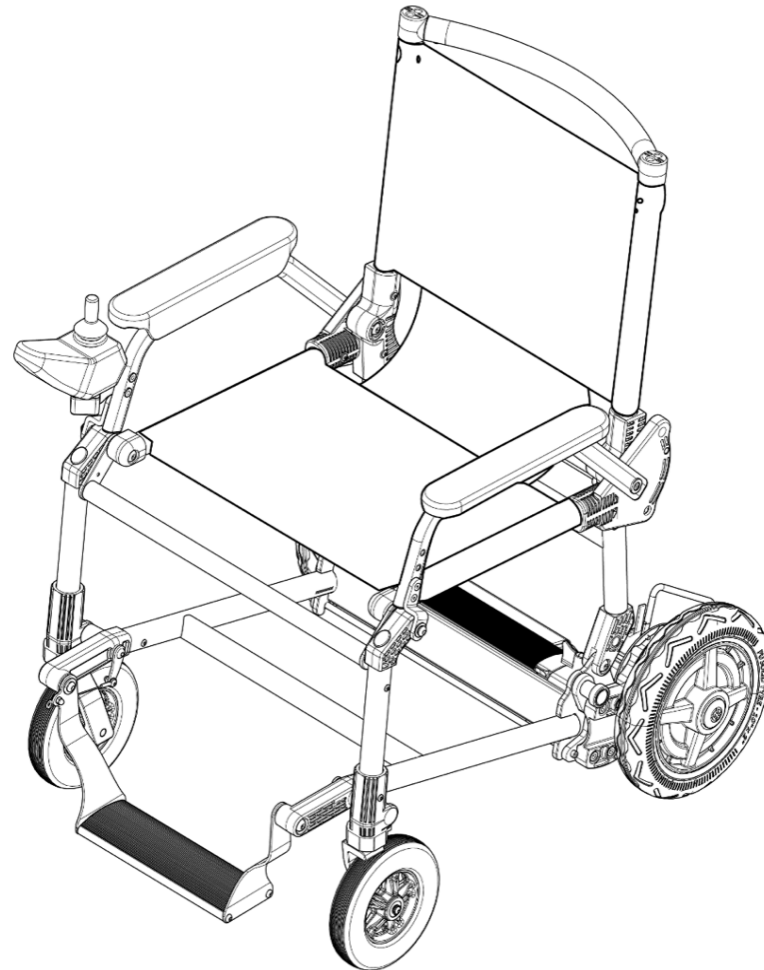

Journey
HEALTH & LIFESTYLE

Table of Contents

User Information and ZOOMER™ LITE General Information.....	4
1. Introduction.....	5
2. ZOOMER™ LITE Layout Front View	6
3. ZOOMER™ LITE Layout Rear View.....	7
4. Safety Warnings Signs.....	8-9
5. Initial Set Up of the ZOOMER™ LITE.....	10
6. Unfolding and Folding the ZOOMER™ LITE.....	11-12
7. Folding the ZOOMER™ LITE.....	13-14
7.1 - 7.2. Frame Quick Release Unfolding & Folding.....	15-16
8. Installing the Battery.....	17
9. Charging the Battery.....	18
10. Electromagnetic Brake System.....	19
11. Maximum Load Limit.....	20
12. Entering and Exiting the ZOOMER™ LITE Safely.....	20
13. Control Panel.....	21
14. Powering On the ZOOMER™ LITE.....	22

15. Safe Joystick Operation.....	23
16. Stationary State.....	23
17. LED Display and Joystick Control of the ZOOMER™ LITE	24-25
18. Technical Specifications.....	26-28
19. Electromagnetic Interference Warning.....	28
20. Reminder Safety Tips.....	29
21. Weather Conditions to Avoid.....	29-30
22. Transporting the ZOOMER™ LITE	30
23. Weight Distribution.....	31
24. Recommended Surfaces and Street Crossing.....	31
25. Traveling on Uneven Surfaces and Avoiding Obstacles.....	31
26. Using the ZOOMER™ LITE on a Ramp.....	32
27. Operating the ZOOMER™ LITE in Reverse.....	32
28. Avoiding Stairs, Steps and Escalators.....	33
29. Battery Safety and Warnings.....	33
30. Battery Maintenance.....	34
31. Over-Current Protector.....	34

32. Removing the Battery.....	34-35
33. Over-Discharge Protector.....	35
34. Lifting the ZOOMER™ LITE	36
35. Troubleshooting.....	37-40
36. Included Components.....	41
37. Anti-Theft Function.....	42
Warranty.....	43

GENERAL INFORMATION BEFORE USING THE ZOOMER™ LITE



GENERAL INFORMATION BEFORE USING THE ZOOMER™:

Before using the ZOOMER™ for the first time, please read this manual completely. This will ensure a safe and enjoyable experience. If you are unable to understand the operating instructions, tips and warnings, please contact your authorized dealer or ZOOMER™ Customer Service at 800-958-8324 M-F between 9am and 8pm eastern time for assistance. The ZOOMER™ must only be used as described in this Manual. Use in manner or methods not prescribed in this manual may negate warranty coverage, where applicable by law.

The ZOOMER™ is a personal electric vehicle, not considered to be a medical device, and has not been submitted to the Food and Drug Administration for review of clearance. The ZOOMER™ is not intended for individuals fully restricted to a seated position. Specifications listed herein are approximates and not always exact and may be subject to change without notice.

REFERENCE DATA:

Authorized supplier: _____

Address: _____

Phone number: _____

Date of purchase: _____

Serial Number: _____

1. Introduction

Thank you for selecting the ZOOMER™ as your mobility partner! The ZOOMER will assist you traveling inside and outside your home. Among the benefits you can enjoy with the ZOOMER are:

- Easy maneuverability inside and outside of the home. The joystick operation is easy to learn and allows you to drive and navigate the ZOOMER with a single hand.
- Easy transportability. The ZOOMER folds down to only 11 inches in a matter of seconds. In its folded position, the ZOOMER can be more easily stored in your home, but more importantly is now a travel companion like no other. It fits easily inside of your vehicle's trunk, cargo space and in many vehicles behind the front seat.
- Flexible Operation. The ZOOMER can be operated with either your right or left hand. Just select the proper side orientation during the set-up process and you are driving!
- A Travel Companion. The ZOOMER is not only an excellent travel companion to take with you in the car, but due to its Lithium Ion battery, it is an airline safe mobility device. Just remove the battery from the ZOOMER before you board the plane. Lithium Ion batteries cannot travel in the cargo area of a plane, but the ZOOMER's standard battery is safe as a carryon item. Check with your airline about how to best travel with your ZOOMER.
- Go Anywhere. The ZOOMER will take you virtually everywhere you want to go.

Your safety is our highest priority! Before using the ZOOMER™ electric mobility chair for the first time, please carefully read and follow all the instructions in this owner's manual. For your safety, it is crucial for you to fully understand all instructions in the manual. (The manufacturer assumes no responsibility for any damages or personal injury caused by the improper use of the ZOOMER™)

If you have difficulty understanding the warnings and/or instructions in this manual, please contact us for support!

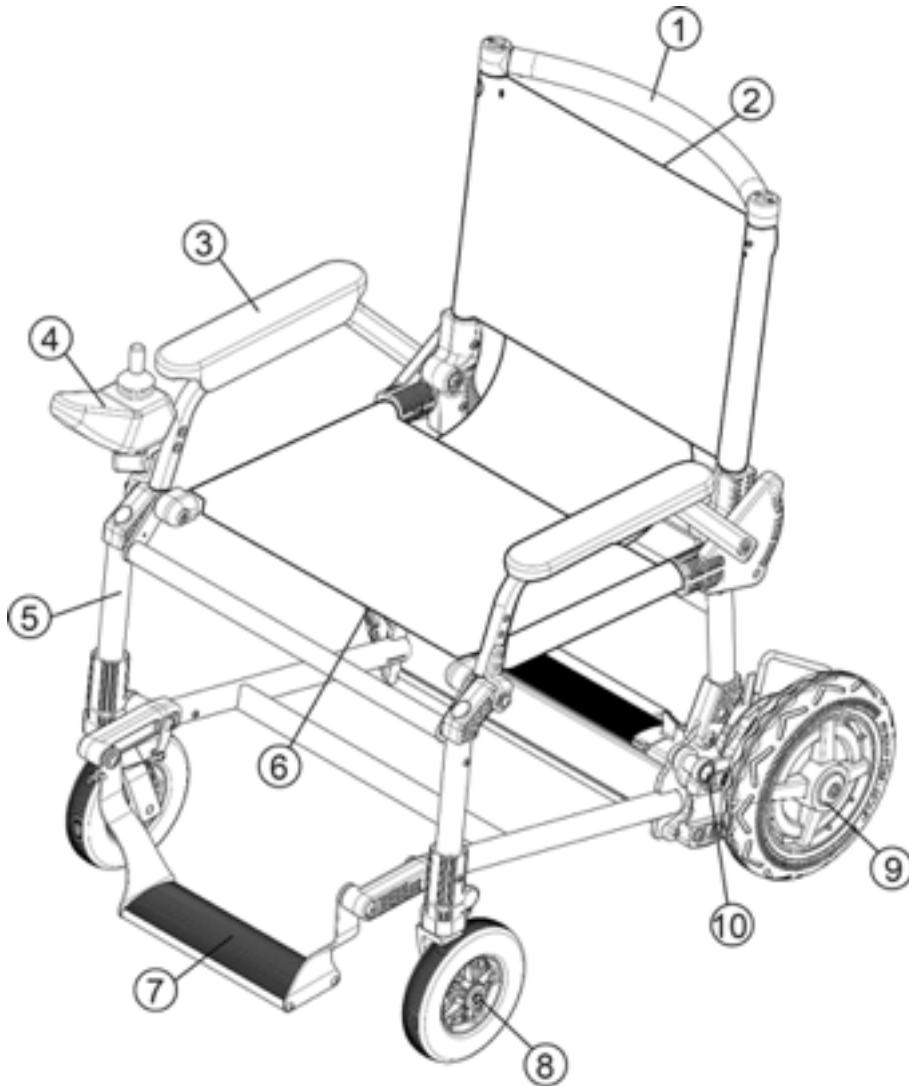



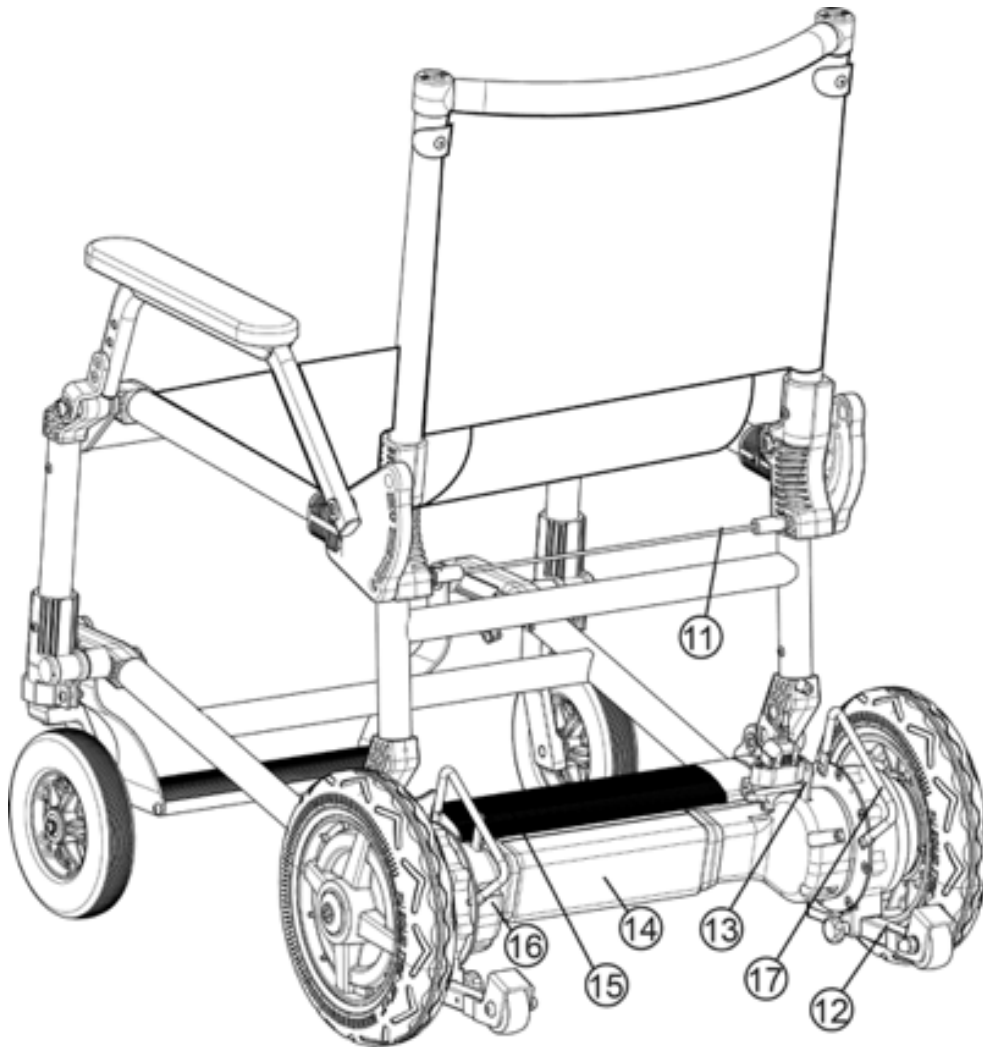



1. Upper back
2. Back
3. Handrail
4. Joystick
5. Front wheel bracket
6. Seat
7. Pedal
8. Front wheel
9. Rear wheel
10. Positioning PIN







- 11. Folding wire rope
- 12. Anti-tilting wheel
- 13. Electromagnetic brake lever
- 14. Lower controller
- 15. Battery
- 16. Motor
- 17. Carrying handle

4. Safety warning signs

The following symbols are used to identify warnings, mandatory measures and prohibited actions. Before using the ZOOMER™ for the first time, please review and understand the signs below.

	<p>Read and follow the instructions in this manual.</p>
	<p>Safety warning sign pertaining to the potential dangers with regard to the operation of this mobility device.</p>
	<p>When operating the ZOOMER™, do not use a mobile phone, walkie-talkie, electronic equipment or other radio transmitting devices that could distract you from correctly operating the chair.</p>
	<p>Keep fingers and hands clear of any potential pinch points.</p>
	<p>Do not operate or store the ZOOMER™ where it could be in contact with rain, snow, ice, salt water, other water sources, etc.</p>
	<p>The battery contains corrosive substances. Handle with care.</p>

	Do not expose the battery to high heat for the risk of an explosion.
	Keep tools and other metal objects away from the battery connectors. It may cause a short circuit damaging the battery or electric shock causing injury.
	The battery contains flammable substances. Avoid contact with an open flame or sources that create sparks. Avoid transporting the battery with other flammable goods.
	Do not discard the battery in the trash! Recycle it!

5. Initial Set Up of the ZOOMER™

Step 1: Lay the carton flat on the floor and carefully remove the ZOOMER™ from the box and its packaging.

Step 2: Unfold the ZOOMER™ by pulling up on the cable on the back of the chair to disengage the locking pins, while at the same time pulling up on the seat back until the chair is in the fully upright position and the two locking pins click into position. Please see the pictures in Section 6 for additional assistance.

Step 3: Loosen and slide out the two anti-tilting wheels on the back side of the ZOOMER™ and tighten the two knobs to lock into position (refer to the photo in Section 7).

Step 4: On the rear of the ZOOMER™, ensure that the two brake levers are in the “ENGAGED” position. See Section 10 for additional assistance on this step.

Step 5: Mount the Joystick Control Panel (as identified in Section 2 Front View of the ZOOMER™, Item 4) where indicated using the two screws included in the box. You may mount the Joystick to either the right side or the left side of the vehicle. The cable that connects the motors to the Joystick is prewired for right hand control. See Step 6 below to rewire the control for Left Handed use (this additional step will take just a couple of minutes).

Step 6: Connect the control panel cable to the cable attached to the underside of the right armrest by carefully plugging it in, then tightening the circular nut until it is hand-tight. The control panel cable will have to be rerouted from the right side to the left side of the ZOOMER if the user needs to operate the ZOOMER with their left hand.

Step 7: Install the battery by following the steps shown below in Section 8. Secure the battery into place rotating the locking lever over the end of the battery.

6. Unfolding and Folding the ZOOMER™

1. Pull up on the collapsing cable to disengage the 2 latching pins.



2. Grab the frame at the same time and pull up to unfold the chair.



The joystick connection line will be automatically connected due to induction



Pay attention to the direction of connector of joystick connection line



3. Completely unfold the frame of the mobility chair until the 2 pins latch securely into their appropriate holes.

 Notice how the pins must be engaged into their holes.

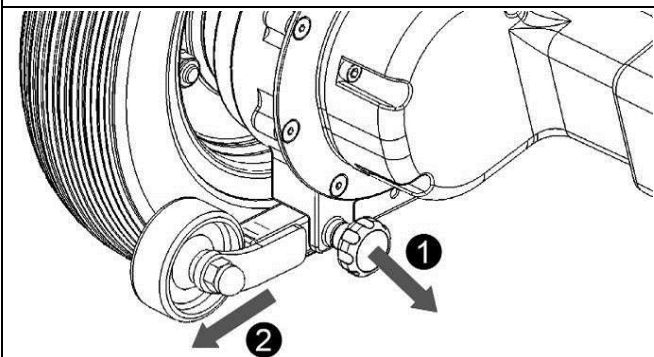
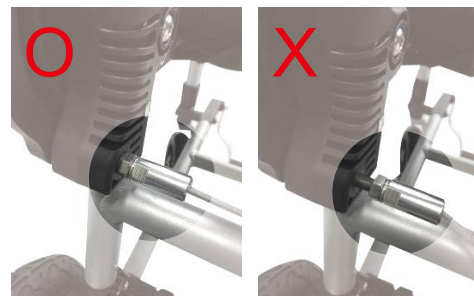

4. Loosen the knob labeled “1” on each side of the mobility chair. Then pull the left and right anti-tilting wheels all the way out. Finally, tighten the two knobs labeled “1” securely.

7. Folding the ZOOMER™

1. Pull up on the collapsing cable to disengage the 2 latching pins.

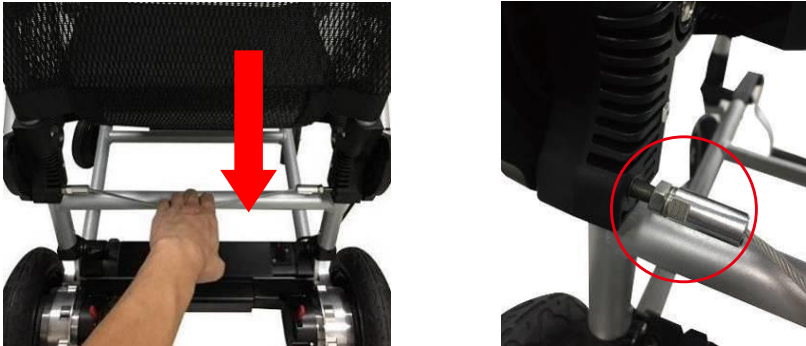

2. As you continue to pull up on the collapsing cable, press down on the frame to collapse the frame.



Continue collapsing the frame until the latching pins engage into their holes.



Double check to make sure the latching pins are engaged.

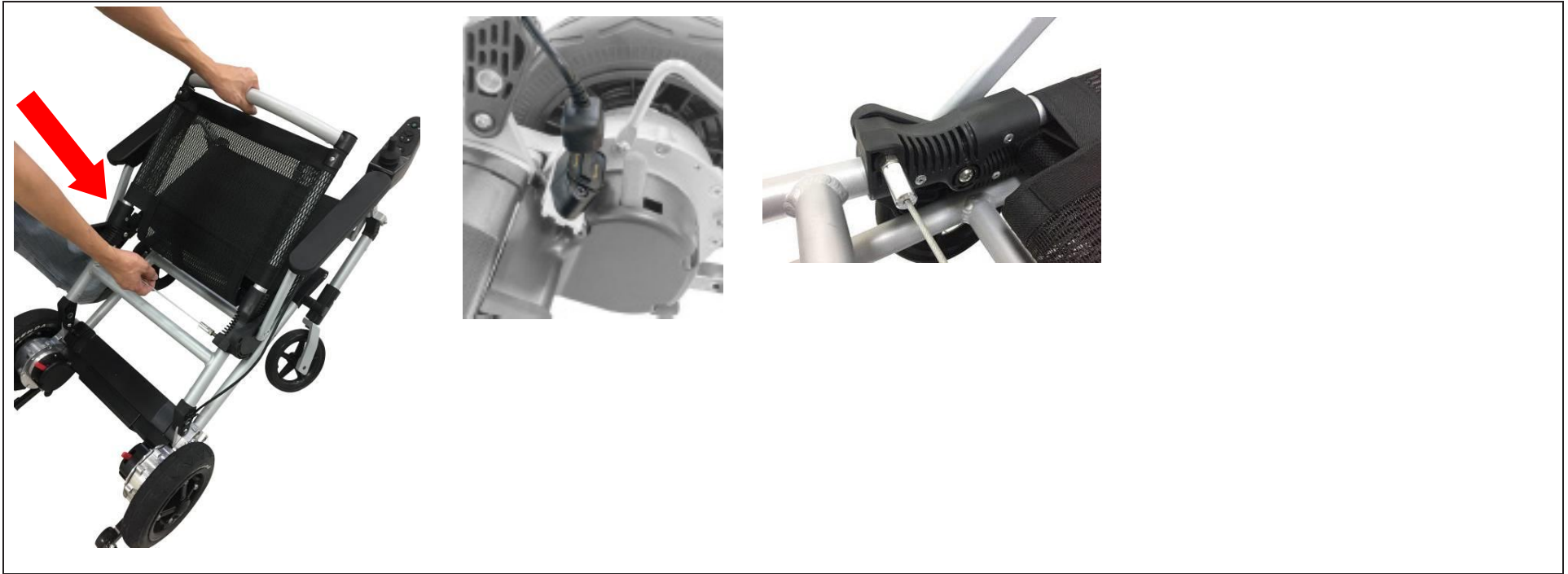

3. Loosen the two knobs labeled "1" and slide the anti-tilting wheels "2" back into the frame. Then retighten the two knobs securely.

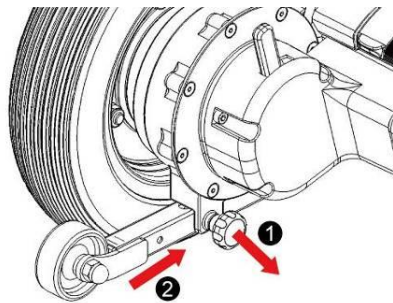

FRAME QUICK RELEASE UNFOLDING & FOLDING



After adjusting, repair or maintenance, all parts should be carefully and safely secured.

7.1. Frame quick release — Split

1. Pull the positioning pin (plunger in rest position)

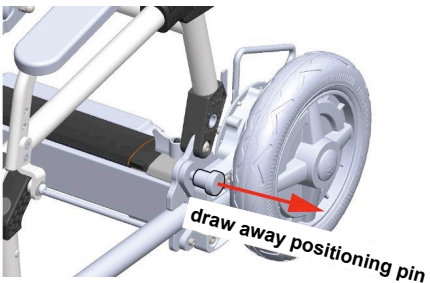

2. Disassemble the Zoomer Lite by following the arrow directions below.



3. The joystick connection line will disconnect automatically.



4. After disassembly, the unit should look like this.



7.2. Frame quick release — Assemble

1. Place the frame of rear wheel into the front frame as shown in the picture



2. It should then look as in the figure below.

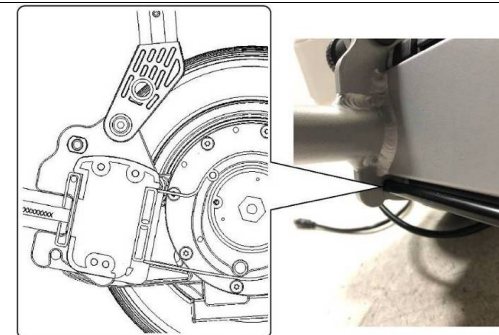

FRAME QUICK RELEASE UNFOLDING & FOLDING

3. Connecting the connection line of the joystick:



The joystick connection line will be automatically connected due to induction.



⚠ Pay attention to the direction of connector of the joystick line during the connection process.

⚠ When handling the Zoomer Lite, grasp parts as shown below and follow the directions of the arrows in the bottom figure. Other unfolding maneuvers may cause injury.

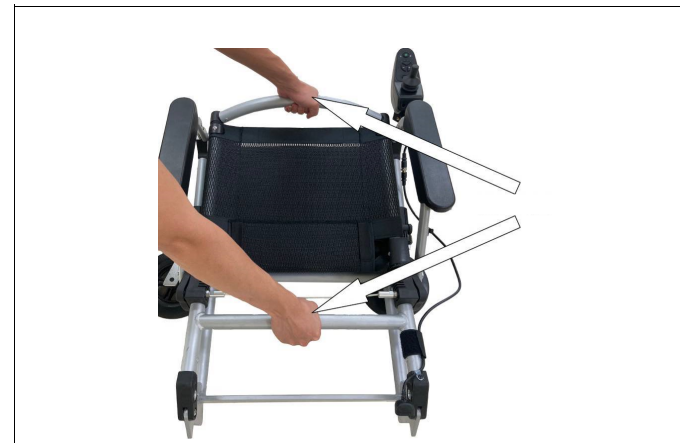

8. Installing the Battery

Hold the battery as shown and align it with the terminals as indicated in Figure E3. After aligning, slide the battery onto the terminals and downward. Press into the holder as shown in Figure E4. Then rotate the battery's holding knob into the middle position. (Figure E5).

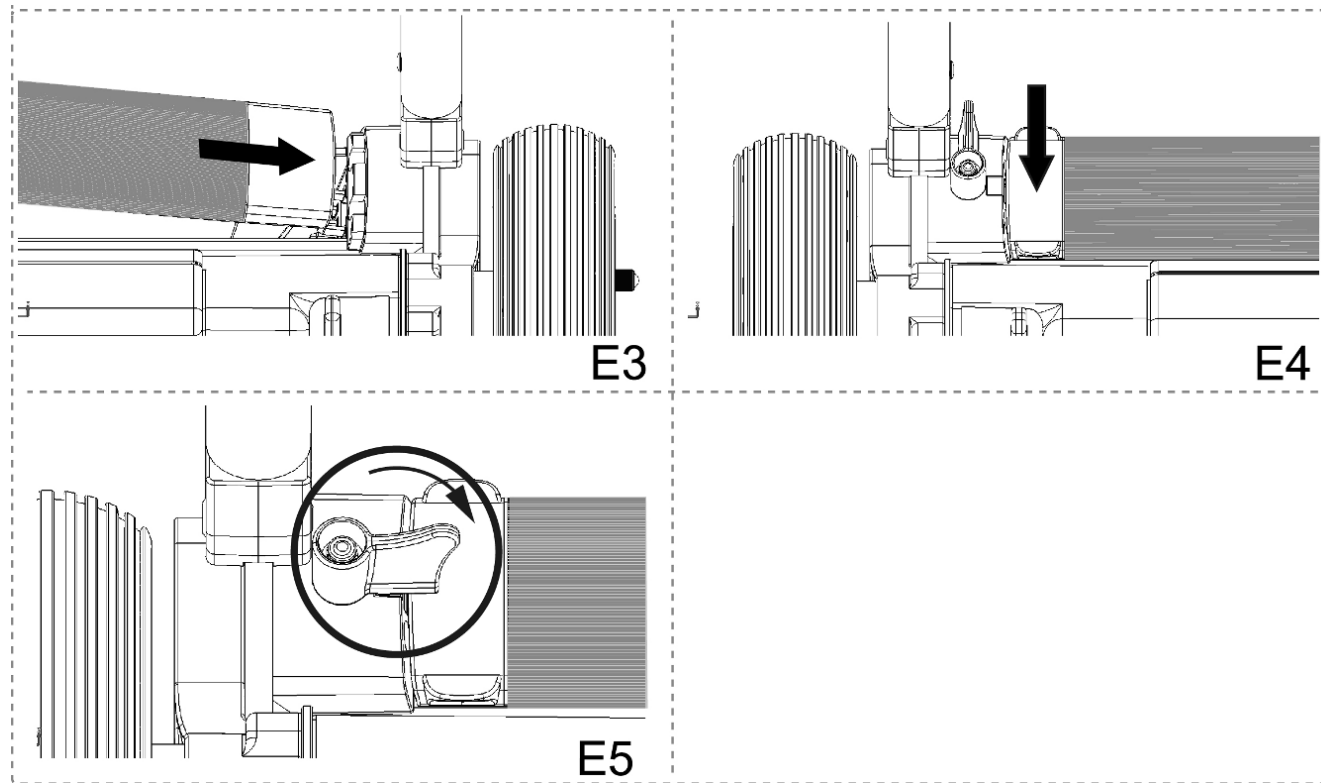

9. Charging the Battery

The battery is charged by standard AC power (AC 110-220V 50-60HZ). The charging port is located on the bottom of the control panel.

1. Insert the 3 prong connector line into the charging port until the latch clicks indicating the connector is inserted correctly. (Figure E6).
2. Insert the separating charger into the power socket, when LED shows green, it means the standby state; when the LED shows red after flashing, it means being charged.
3. When the charger LED becomes green from red, it has been fully charged.
4. After charging, it is recommended to unplug the charger plug from the wall receptacle first. Then push the latch button, grab the connector and pull it out of the socket. (Note: Do not grab the cable and pull...grab the connector and pull.)
5. Charge batteries only within the appropriate ambient temperature: 23 F to 104 F (-5°C to 40°C).

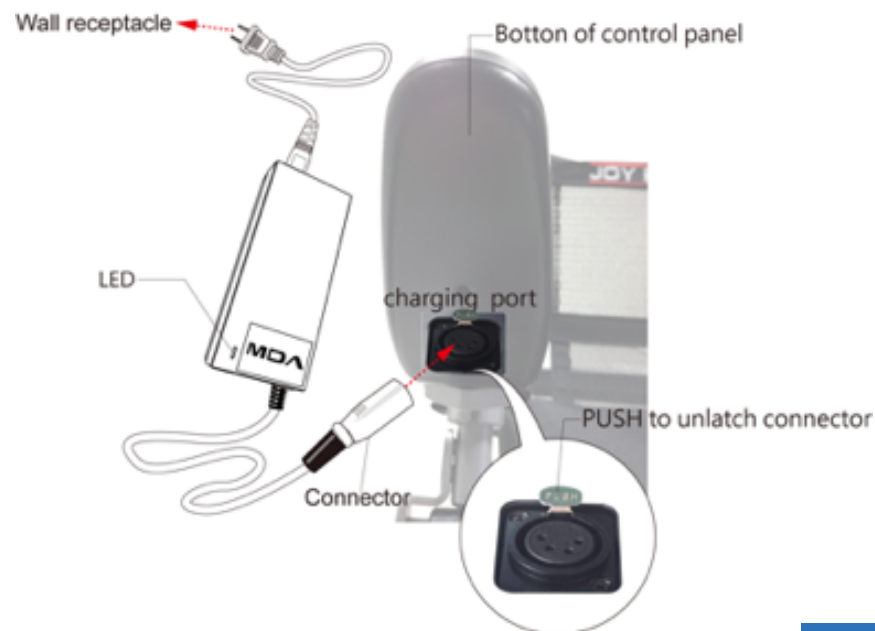

10. Electromagnetic Brake System

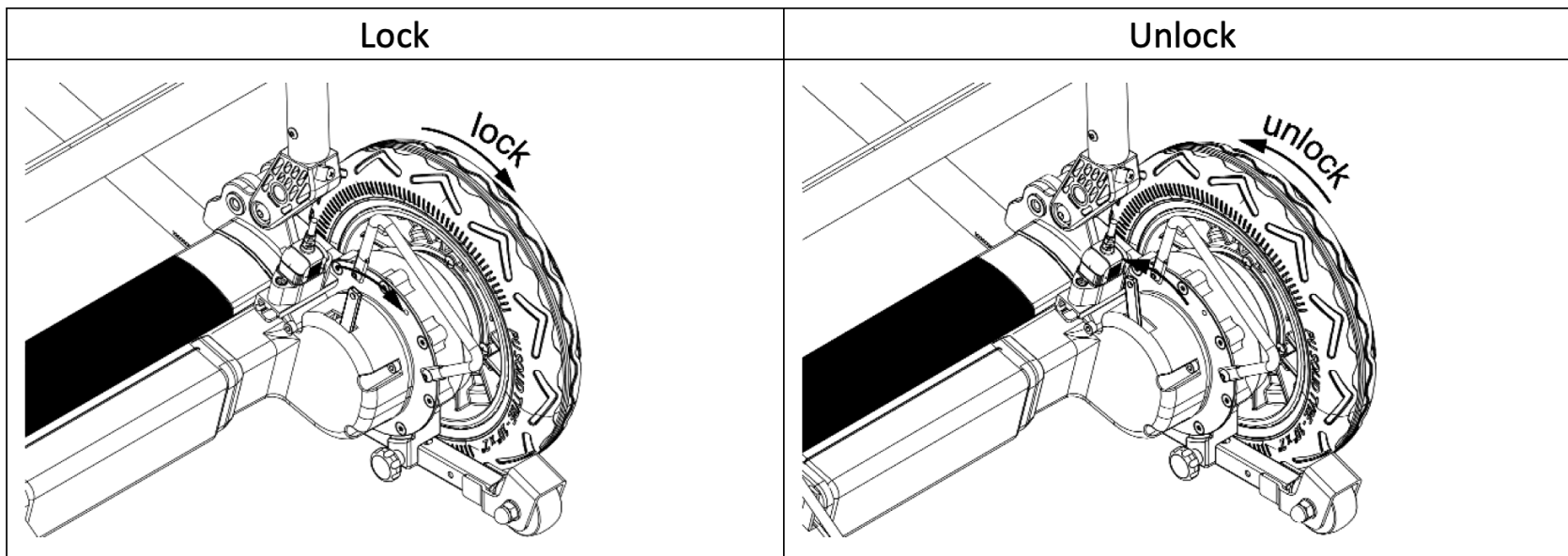

The ZOOMER™'s braking system has two modes: “Drive” and “Free Wheeling” which are labeled as “Lock” and “Unlock”, respectively on the ZOOMER™.

Drive or Lock: When the brake lever is in the “Drive” position, the electromagnetic brake system is “On”. When the ZOOMER™ is moving, releasing the Joystick or moving it to a neutral position (center), the ZOOMER™ will automatically cause the ZOOMER™'s brake to engage. Only enter and exit the ZOOMER™ when the levers are in the Drive or Lock position. The rear wheels will not rotate without using the joystick when the Electromagnetic Brake System is in Drive Position.

Free Wheeling or Unlock: Switch to "Free Wheeling" mode by pushing the position the rear wheels rotate freely so that the ZOOMER™ can be moved around freely. This mode can be useful if a Caregiver will be pushing the ZOOMER™ with a rider in the chair.



Do not sit in the ZOOMER™ with the levers in the “Free Wheeling” position without assistance from a caregiver! Never switch the levers to the “Free Wheeling” position while on an incline! This operating position is dangerous for the ZOOMER™, riders and pedestrians if you lose your grip on the chair!

11. Maximum Load Limit

The maximum user weight capacity of the ZOOMER™ is 253 pounds. Operating the ZOOMER™ above the maximum weight capacity may result in damage to the seat frame, lower control board, the drive motors, and is unsafe.

Note: Exceeding this weight limit will void the warranty.

12. Entering and Exiting the ZOOMER™ Safely









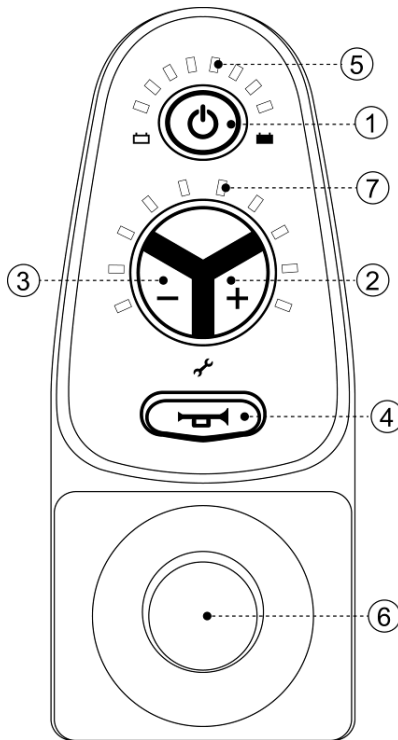

Please note the following points in order to avoid, or reduce, the chance of falling:

Before getting into or exiting the ZOOMER™, ensure the power is OFF and the Brake Levers (2) are in the Lock or Drive position. The rider should never exist the ZOOMER™ when the rear wheels are in “Free Wheeling” mode as this is unsafe and the ZOOMER™ may move from underneath the rider. It is advised that before entering the ZOOMER™ the user double check to make sure that the wheels are not in Free Wheel mode and that the rear wheels do not freely turn.

Do not step on the foot rest while entering or exiting the ZOOMER™. You should swing it back out of the way to allow you to have your feet on the floor as you enter or exit the ZOOMER™. Then use the arm rests to support yourself as you either lower yourself into the seat or lift yourself out of the seat.

13. Control panel



1	 <p>Power button</p>	Press this button to turn on the power. Press again to turn the power off.
2	 <p>Acceleration button</p>	Press this button to increase the speed of the mobility chair. There are 5 speed levels.
3	 <p>Deceleration button</p>	Press this button to decrease the speed of the mobility chair.
4	 <p>Horn</p>	Press this button to honk the horn.
5	 <p>Battery power display</p>	These LED lights display the remaining battery charge. All lights lit mean a full charge.
6	 <p>Joystick</p>	Controls the direction and speed of the mobility chair.
7	 <p>Speed display</p>	These 10 LED lights indicate what speed range you are operating. The more lights lit the faster speed range you are operating.

14. Powering On the ZOOMER™

After the control panel is mounted (see figure A1) and connected per the assembly instructions, and you are sitting in the ZOOMER™, press the power button on the control panel. The panel lights should come on. If not, check to ensure that control cable is correctly connected to the Joystick Controller and the battery is installed correctly.



15. Safe Joystick Operation

When operating the ZOOMER™ for the first time, start slowly by gradually pushing the joystick forward. Practice will help you become familiar with how to control the movement. Simply push the joystick in the direction you wish to go. Pushing the joystick more in the forward direction will make the mobility chair go faster. The ZOOMER™ will gradually increase its speed when starting and the maximum speed is 3.7 mph (6 km/h).

Do not turn the mobility chair suddenly at high speeds to avoid risk of tipping.

The joystick is equipped with a spring which will return it to the center position when you release it. Be careful not to release the joystick too suddenly. The sudden release of the joystick may cause loss of balance and could cause you to overturn, resulting in personal injury.

You can turn the ZOOMER™ on its axis by moving the joystick either directly right or left from the stationary position.

16. Stationary State

When the mobility chair is not in use, the power should be switched off. (see Figure A2) This will help prevent unintentional movement of the ZOOMER™ by accidentally moving the joystick. This will also help prolong the battery charge.

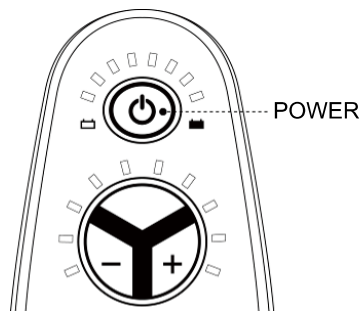

17. LED Display Notifications Guide

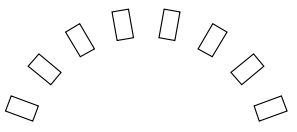
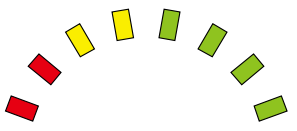
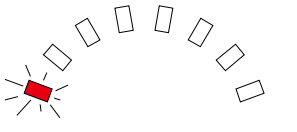
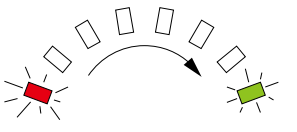
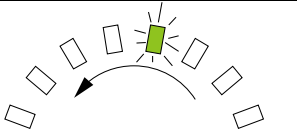
LED Lights Display	Description	Message	Remarks
	No lights are lit	Power supply is switched off or in standby state, or the system has entered into the sleep mode	
	All LED lights are lit	The power supply is turning on	The fewer LED lights that are on, the less battery life there is
	Red LED light on the left side flashes	Battery needs to be recharged	Please charge the battery as soon as possible
	LED's light up from left to right in order one time	The ZOOMER® has just been turned on	
	Only one light moves from right to left, again and again	The mobility chair has entered into the anti-theft mode	To unlock, press the acceleration button "+" 3 times within 10 seconds to unlock

	<p>LED's light up from left to right in order again and again.</p>	<p>The mobility chair is still in the charging mode.</p>	<p>The joystick will not function when connected to the charger. This is a safety feature.</p>
--	--------------------------------------------------------------------	----------------------------------------------------------	------------------------------------------------------------------------------------------------

Activating the anti-theft mode: After switching on the power, press and hold the power button for 4 to 5 seconds. This will turn off the power supply and will activate the anti-theft mode.

	<p>Move</p>	<p>Control the Joystick</p>
	<p>Move forward</p>	<p>Push the joystick forward to move forward</p>
	<p>Move backward</p>	<p>Pull the joystick backward to move in reverse</p>
	<p>Move rightward</p>	<p>Push the joystick to the right to turn to the right</p>
	<p>Move leftward</p>	<p>Push the joystick to the left to turn to the left</p>
	<p>Stop</p>	<p>Gradually return the joystick to the center position to slow down and stop</p>

Size unfolded:	length x width x height	33.6 x 26 x 35.8 inches (855×660×910 mm)
Size folded:	length x width x height	43.9 x 26 x 12.6 inches (1115×660×320 mm)
Suggested user weight		275 lb (125 kg)
Gross weight		Weight with battery: 49.2 lbs (22.3 kg) Weight without battery: 45.2 lbs (20.5 kg)
Maximum climbing angle		10° (depending on the weight of the user)
Range (with fully charged battery)		8.1 miles (varies with the user's weight, terrain, ground environment, battery status, environment, and driving habits)
Maximum speed		3.7 mph (6 kph)
Maximum turning radius		35.4 inches (900 mm)

Motors	
Type	DC brushless motor
Motor power	200 watts (x2)
Input voltage	24 volts DC
Number of motors	2 units
Brake system	Electromagnetic brake
Braking distance	Within 39.4 inches (100 cm)
Battery	
Type	Lithium battery
Rated capacity	8.7 Ah
Output voltage	24 volts DC
Controller	
Type	Double-drive design controller for brushless DC motors

Front wheels	
Size	7 inches (178 mm)
Type	Solid PU tires
Number of wheels	2 wheels
Rear wheels	
Size	10 inches (254 mm)
Type	PU solid tire
Number of wheels	2 wheels

19. Electromagnetic interference warning



Exposure to excessive amounts of electromagnetic interference (EMI) may affect the function of the ZOOMER™ or possibly cause damage to the braking system and control system. Some examples of devices that emit large amounts of EMI radiation are large AC motors, large DC motors, etc.

20. Reminder Safety Tips



Safety guidance

Be certain to read this complete owner's manual before operating the ZOOMER™.

Check the battery charge periodically to ensure that the battery has enough charge to get you to your destination.

Keep tools and metal items away from the battery's positive and negative poles. Connecting the two poles together can lead to short-circuiting and/or electric shock.

When you use the ZOOMER™ for the first time, drive safely until you have adapted yourself to the ZOOMER™ and its functions.

Do not attempt to drive over a drop in the sidewalk or pavement.

Do not reach outside the wheel base of the ZOOMER™ causing you to lean too far forward or too far to the side. This could cause a shift in your center of gravity causing you to tip over suddenly.

21. Weather Conditions to Avoid



For safety reasons and to help prevent equipment failure, please follow the guidelines below:

Do not operate the ZOOMER™ in the rain, snow or icy conditions. This type of weather can seriously hamper your ability to control the motion of the ZOOMER™. It may also affect the function of the mobility chair.

WEATHER CONDITIONS TO AVOID, TRANSPORTING THE ZOOMER™ LITE



Always keep the ZOOMER™ in a clean and dry place. The mobility chair is not waterproof.

A high humid environment could lead to the corrosion on the frame.

Keeping the ZOOMER™ in a controlled and acceptable environment is best in order to not reduce the life of the unit.

Please avoid storing the mobility chair in the following environments: where there is direct contact with water; extremely high or low temperatures; or in extreme humidity.

Please do not use the mobility chair in the shower.

Please do not use the mobility chair near water sources such as rivers, lakes, etc.

Please do not spray-wash the mobility chair with water.

Do not use the ZOOMER™ on wet or slippery surface. You could lose traction and therefore lose control of the mobility chair, especially if the surface is an inclined surface.

Note: If the mobility chair does accidentally get exposed to water (or heavy moisture), remove the battery, wipe the battery and the ZOOMER™ down with a dry cloth and let both battery and mobility chair dry naturally. After the mobility chair and battery are completely dry, the battery can be reinstalled.

22. Transporting the ZOOMER™

The ZOOMER™ is easily transportable. Just fold the mobility chair into the flat position unit it latches. Move the brake levers (2) to the “Free Wheeling” position. Now you can grab the cross bar, lift the one end and you pull the ZOOMER™ behind you. You can place the ZOOMER™ into the trunk of your car or store it in a storage area when not in use.

23. Weight Distribution



In order to avoid tipping the ZOOMER™ when driving the mobility chair, pay close attention to your weight distribution. It is recommended that you sit completely back in the seat in order to distribute your weight evenly. Sitting too far forward could cause the ZOOMER™ to tip forward.

When traveling up a slope, do not lean excessively back in the seat. When traveling down a slope do not lean too far forward. Best to keep your weight evenly distributed in the seat.

24. Recommended Surfaces and Street Crossing

The ZOOMER™ is designed to operate on dry surfaces such as flooring, level sidewalks, low angle dry inclines, etc. Please do not use the ZOOMER™ on the sand, uneven surfaces, very loose gravel, high grass, rough pavement, etc. These surfaces may cause damage to the wheels, bearings, shafts, motor and other parts.

Please pay attention to local traffic rules when crossing the street in the mobility chair.

It is strongly recommended that you wear reflective clothing when using a mobility chair at night.

25. Traveling on Uneven Surfaces and Avoiding Obstacles



You must be cautious when traveling on surfaces that are not level and flat. You must be cautious when traveling on inclining and declining slopes. Be aware of the edge of the road or sidewalk while driving the ZOOMER™. When operating a mobility chair there is always the risk of overturning, so it is not recommended

to travel on bumpy or rough roads. Always pay attention to your surroundings. Follow the recommendations by not traveling up or down inclines that are steeper than 10 degrees. Be sure to slow down when getting close to obstacles and steer around them carefully.

26. Using a Ramp



Great caution should be observed when driving up or down a ramp!

Never drive the mobility chair on slopes over 10 degrees.

Never turn around when you are on a slope! You may be at risk of tipping over the ZOOMER™.

Avoid driving on inclines that are wet or slippery.

Do not drive the mobility chair on uneven slopes.

It is recommended not to drive on continuous uphill or downhill paths.

27. Operating the ZOOMER™ in Reverse



Be cautious and go slow when driving the mobility chair in reverse. Be aware of uneven surfaces and obstacles. Do not drive the ZOOMER™ backwards on a slope!





28. Avoiding Stairs, Steps and Escalators



ZOOMER™ should not be used to travel upstairs, downstairs or on escalators!

Doing so could cause serious damage to you and the ZOOMER™.

29. Battery Safety and Warnings

	Keep metal tools and other metal items away from the battery terminals. Contact with them may cause a short circuit or an electric shock.
	Keep batteries away from flammable materials. Avoid exposure to open fire and spark sources. Do not transport the battery and flammable or combustible goods together.
	Corrosive substances are inside the battery. Do not dismantle the battery.
	When the battery is being charged, place the mobility chair and battery charger in a well-ventilated place, away from any fire or sparks.



Warning: When charging the ZOOMER™, keep the power cord away from children and pets.

30. Battery Maintenance

The service life and performance of the battery can be affected by the environment's temperature, the user's weight and the terrain traveled, etc. The recommended operating temperature for the battery is 23°F (-5C) to 104 F (40 C). Normal charging time is about 4 hours. If the battery has been run down to the lowest level, it may take 5 to 6 hours to charge. The LED light on the charger will turn green when the battery is fully charged. When not using the ZOOMER™ for long periods of time you should charge the battery every 2 months to prevent a fully expired battery. Failure to follow these guidelines could cause damage to the battery.

31. Over-Current Protector

The ZOOMER™ also has an overcurrent protector. If the current supplied to the motor is too high, the over-current protector will cut off the current supply. If you try to climb an incline more than 10 degrees or if the user weighs more than 255 lbs, the current protector could activate. The result is the controller will cut off the circuit to prevent excessive current from overloading and overheating the motor.

32. Removing the battery

Before removing the battery, turn the power off on the control panel.

Rotate the battery latch so that is no longer over the battery. (Figure E1)

Grab the battery on the left hand side and pull up. Now you are able to pull the battery out of its base. (Figure E2)

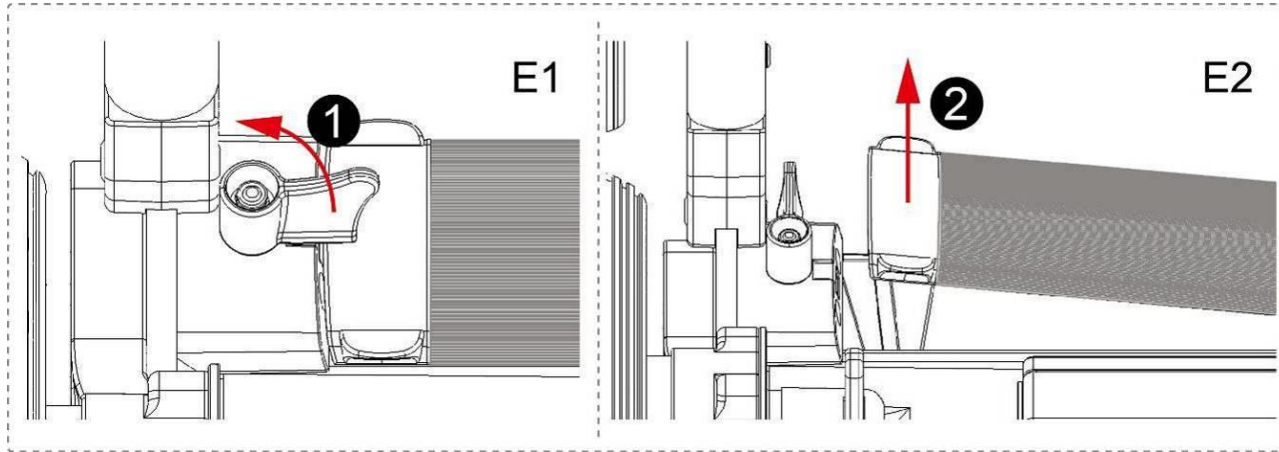

33. Over-Discharge Protector

If the battery is fully discharged, permanent damage to the lithium batteries will result. Therefore the ZOOMER™ battery has an over-discharge protector. When the lithium battery is close to being exhausted the protector will automatically cut off the circuit, and the controller will stop working. So when you see the red LED light flickering, you need to charge the battery. Once you see the red light flickering, please charge the ZOOMER™ battery within one week.



When the battery is out of power, please charge within one week.

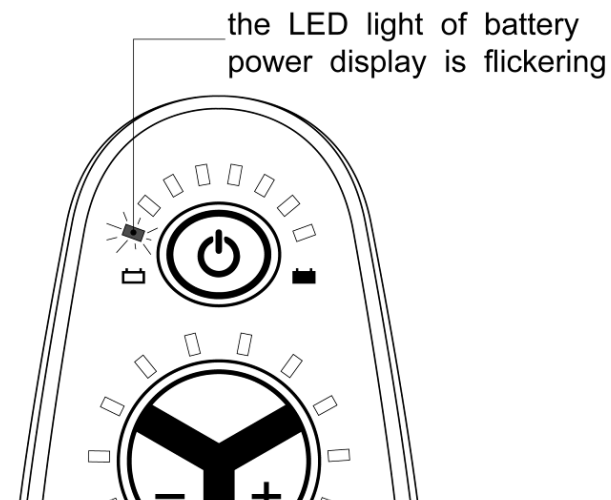

34. Lifting the ZOOMER®



When lifting the mobility chair, first check to see that the two locking pins are engaged into their holes. Then place your hands on the frame as shown below. Lift the ZOOMER™ using your legs and keeping your back straight.

Important note: This procedure is intended for individuals who are able to lift the weight of the ZOOMER™ (approximately 50 lbs or 22.6 kg)



35. Troubleshooting

Some issues of the mobility chair will be displayed in the speed display lights through the fault codes in the form of LED lights flashing on the control panel. When a problem occurs, refer to the table below for the appropriate flashing light fault code.

When a "fault code" LED light is flashing, first shut down the ZOOMER™ and restart. If the flashing "fault code" LED light is still flashing, please refer to the table below to find possible causes and corrective actions. If you are unable to confirm the causes of the fault, please contact your local dealer for service support.

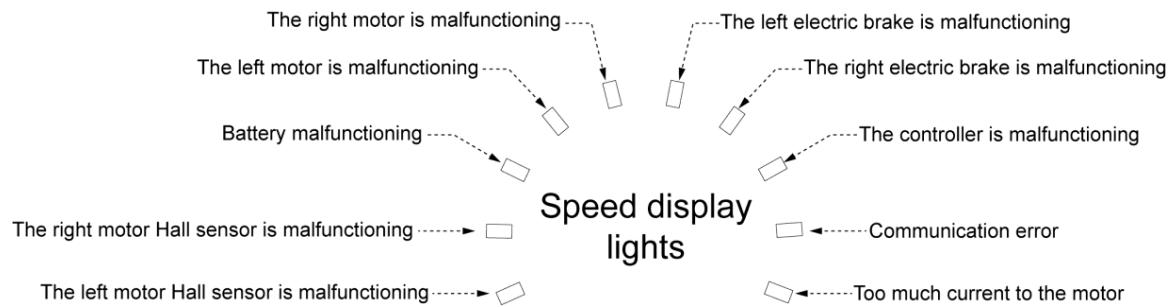

Electric mobility chair malfunction diagram

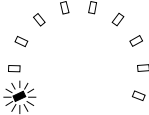
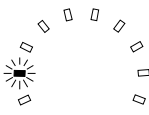
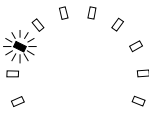
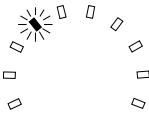

Potential Malfunctions

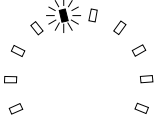
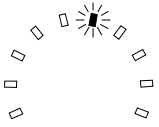
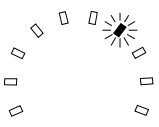
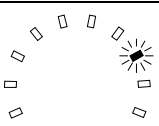
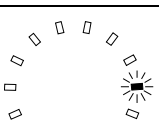
Malfunction	Explanation	Solution for malfunction
 1 st light flashes	The left motor Hall sensor is malfunctioning	Contact your local dealer for service support.
 The 2nd light flashes	The right motor Hall sensor is malfunctioning	Contact your local dealer for service support.
 The 3rd light flashes	Battery is malfunctioning	Charge the battery.
 The 4th light flashes	The left motor is malfunctioning	Check for a loose terminal connection on the motor.

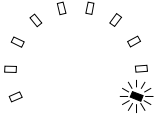
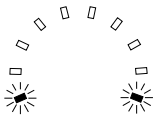
 <p>The 5th light flashes</p>	<p>The right motor is malfunctioning</p>	<p>Check for a loose terminal connection on the motor.</p>
 <p>The 6th light flashes</p>	<p>The left electric brake is malfunctioning</p>	<p>Check whether the left electric brake is in the “Free Wheeling” position. If so, move the left lever to the “Engage Drive” position. Also check for loose terminal connections.</p>
 <p>The 7th light flashes</p>	<p>The right electric brake is malfunctioning</p>	<p>Check whether the right electric brake is in the “Free Wheeling” position. If so, move the right lever to the “Engage Drive position”. Also check for loose terminal connections.</p>
 <p>The 8th light flashes</p>	<p>The controller is malfunctioning</p>	<p>Contact your local dealer for maintenance.</p>
 <p>The 9th light flashes</p>	<p>Communication error</p>	<p>Check the connection of the console cable.</p>

 <p>The 10th light flashes</p>	<p>Too much current to the motor.</p>	<p>Stop the ZOOMER™ by returning the joystick to the middle position.</p>
 <p>The 1st and 10th light flashes</p>	<p>Too high voltage for the battery.</p>	<p>Check the output voltage of the battery. It should not exceed 35 volts.</p>
 <p>All lights flashing</p>	<p>The joystick is not in the middle position.</p>	<ol style="list-style-type: none"> 1、 Be sure when turning on the power that the joystick is in the middle position. 2、 If the joystick is in the middle position and all the lights continue to flash, then the joystick may be malfunctioning - contact your local dealer for service.

Battery power display

 <p>Only one light flashes and moves from left to right to left, over and over</p>	<p>The ZOOMER™ is in the anti-theft mode</p>	<p>Press the power button to turn on the ZOOMER®. Then press the acceleration button “+” 3 times within 10 seconds to unlock the mobility chair.</p>
-----------------------------------------------------------------------------------------------------------------------------------------------------------------------	----------------------------------------------	------------------------------------------------------------------------------------------------------------------------------------------------------

36. Included Components

Name	Quantity	Remarks
Mobility Chair	1	/
Lithium battery	1	/
Joystick controller	1	/
Charger	1	/
Owner's manual	1	/

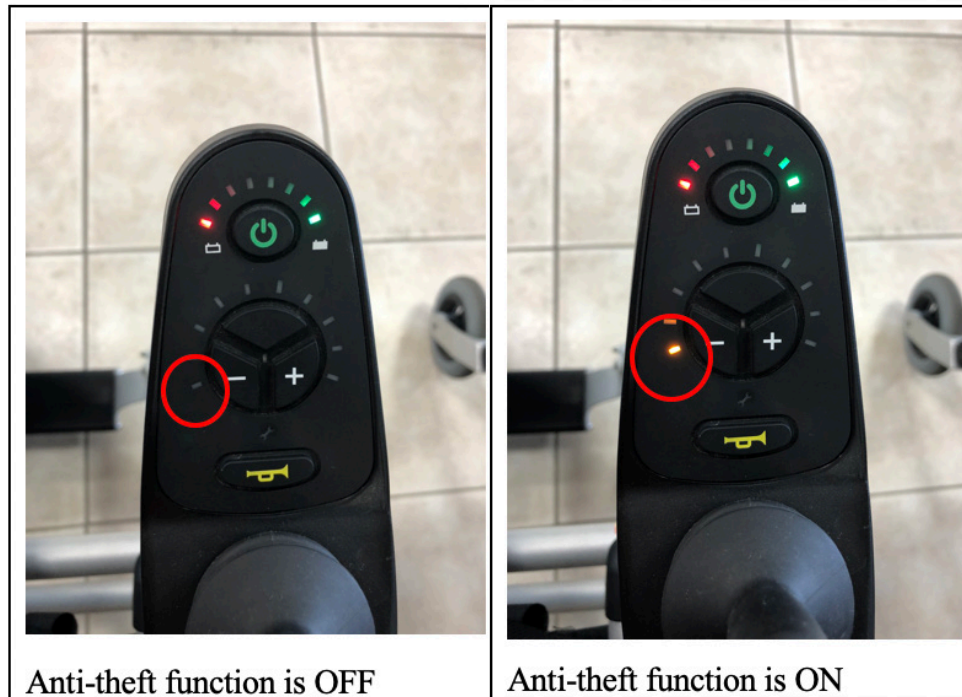

Anti-theft mechanism

After switching on the power supply, press and hold the power button for 4-5 seconds to turn off the power supply automatically, then it has entered the anti-theft mechanism, if locked, it cannot be operated.

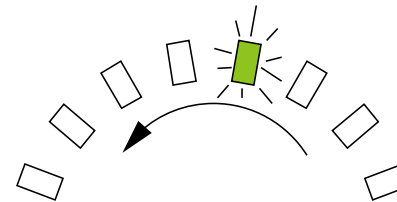

Only one light moves from right to left, again and again, which means that this product has entered the anti-theft mechanism, waiting for unlocking. Press the acceleration button for 3 times in 10 seconds to unlock.

ZOOMER™ LITE Chair Limited 12 Month Warranty

Journey Health & Lifestyle warrants the frame, mechanical and electrical components including the motor to be free from defects in materials and workmanship for a period of twelve (12) months from the original purchase date. The originally supplied battery, tires, fabric seat and seat back and the seat cushion are all warrantied to be free from defects in materials and workmanship for a period of six (6) months from the original purchase date. If within such warranty period any such component or part shall be proven to Journey Health & Lifestyle's satisfaction to be defective, the product shall, at Journey Health & Lifestyle's option, be repaired or replaced with new or refurbished product components. In some cases an installation kit may be provided to the owner to facilitate installation of a replacement product component. This warranty does not provide for any labor charges incurred in product component installation. The warranty period of the repaired or replaced product shall terminated with the termination of the warranty period for the original product. Journey Health & Lifestyle's sole obligation and your exclusive remedy under this warranty shall be limited to such repaired or replaced product. Contact Journey Health & Lifestyle before sending any product for warranty repair or replacement. Do not send any product without the prior consent of Journey Health & Lifestyle.

Limitations and Exclusions:

This warranty does not cover damage, deterioration or malfunction resulting from accident, negligence, misuse, abuse, use by combined rider plus cargo weight above that specified in this User Manual; improper storage; the normal gradual reduction in battery performance due to heavy use; improper operation or failure to follow instructions according to this User

Manual; damage in shipment of the product (claims must be presented to the carrier); repair, attempted repair or modifications made by anyone other than Journey Health & Lifestyle; any unit on which the serial number has been defaced, modified or removed; normal wear items including but not limited to inner tubes and grips; any periodic maintenance; deterioration due to perspiration, corrosive atmosphere or ground covering such as pine needles or crushed limestone dust, or other external causes such as punctures, extremes in temperature and humidity; damages related to lightning, flood or circumstances beyond Journey Health & Lifestyle control; or products subjected to commercial or institutional use.

This warranty applies in North America only and is extended only to the original purchaser of the Zoomer Lite product when purchased directly from Journey Health & Lifestyle (USA) or its authorized distributors and is nontransferable. If you purchased a ZOOMER LITE from one of Journey Health & Lifestyle's authorized dealers, your first remedy for warranty claims is through the dealer from which the ZOOMER LITE was purchased. This warranty gives you specific legal rights and you may also have other legal rights which may vary from place to place.

The foregoing warranty is exclusive and in lieu of all other express warranties, implied warranties, if any including but not limited to the implied warranties of merchantability and fitness for a particular purpose, and shall not extend beyond the duration of the express warranty provided herein. Journey Health & Lifestyle shall not be liable for any consequential or incidental damages whatsoever and disclaims any liability beyond the initial purchase price of the Zoomer Lite product.

Copyright © 2022 Journey Health & Lifestyle

If you have any questions, call us at our toll-free number:

1-877-421-3724

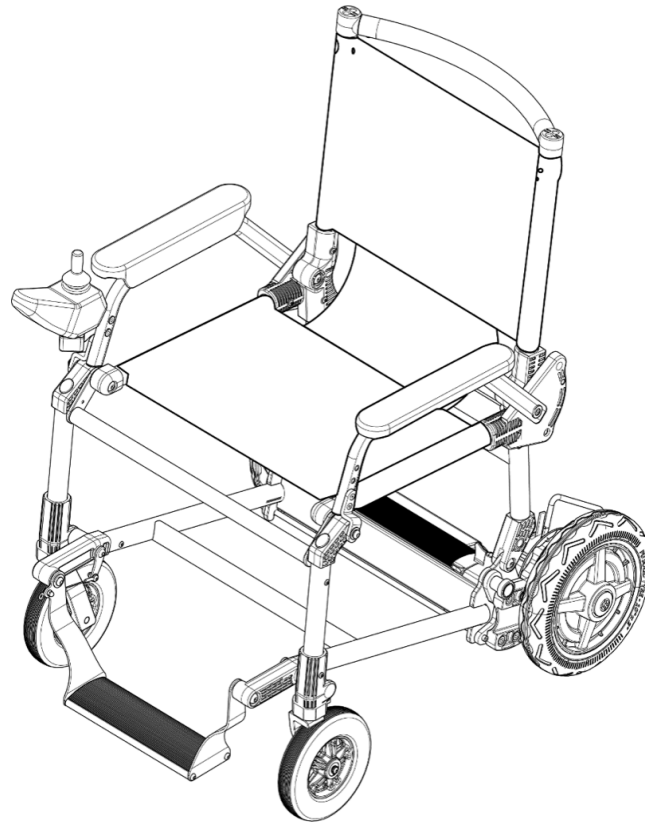

Journey
HEALTH & LIFESTYLE

ZOOMER™

LITE

If you have any questions, call us at our toll free number:

1-877-421-3724