

INSTRUCTIONS FOR USE

Maxi Move



WARNING

To avoid injury, always read this Instructions for Use and accompanied documents before using the product.



Mandatory to read the Instructions for Use

Design Policy and Copyright

® and ™ are trademarks belonging to the Arjo group of companies.

© Arjo 2020.

As our policy is one of continuous improvement, we reserve the right to modify designs without prior notice. The content of this publication may not be copied either whole or in part without the consent of Arjo.

General Information	5
Definitions Used in this Manual	5
Manufacturer Information	5
Intended Use	5
Conditions	6
Operational Life	6
Policy on Number of Staff Members Required for Patient Transfer.....	6
Safety Instructions	7
Symbols Used	7
Homecare Environment Considerations	8
Product Description/Functions	9
Parts Referred to in this Manual	9
Slings.....	11
Controls and Features	13
Control Handset.....	13
Control Panel	13
Stop Button (red)	13
Power Button (green).....	13
System Failure Wind Down Facility	14
Automatic Cut-Out	14
Anti-Crush System.....	14
Battery Indicator.....	14
Sleep Mode.....	14
Usage Counter.....	15
Adjustable Width Chassis Legs	15
Chassis Castor Brakes	15
Jib and Spreader Bars/Stretcher Frame	15
Using your MAXI MOVE	16
Before Approaching the Patient.....	16
Powered Opening “V” Chassis	16
MAXI MOVE ‘Lock and Load’ System	16
Testing the Attachment.....	17
Using the DPS Spreader Bar.....	18
To Lift from a Chair	18
To Lift from the Bed	19
To Lift from the Floor	21
Powered DPS Spreader Bar.....	22
Care of Your Powered DPS Spreader Bar	23
Using the Loop Spreader Bar	23
To Lift from a Chair	24
To Lift from the Bed	25
To lift from the Floor.....	25
Using the Stretcher Frame	25
Using the Soft Stretcher	25
Scale	28
Patient Scale Information	28
Descriptive Marking/Seals C.E. Units only	28
Reinspection	28
Display Symbols/Functions	28
Overload Warning Symbol.....	29
Method A - Weighing Before the Patient is Suspended in the Sling.....	29
Method B - Weighing with the Patient Already Suspended in the Sling	30
Units of Measure	31
Scale - Handset Instructions Mini-Guide.....	32
Battery Charging	34
Battery Pack	34

Contents

Removing the Battery Pack	34
Charging your Battery	34
Battery and Battery Charger Safety Practices	35
Care of your MAXI MOVE	36
Sling Cleaning and Care	36
Lift Cleaning, Disinfection and Care.....	36
Mandatory Daily Checks	39
Periodic Testing	39
Servicing Advice	39
Troubleshooting.....	40
Labels.....	41
Technical Specifications	42
Lift Dimensions	43
Appendix - Scale Gravity Code Configurations	45
Viewing the Gravity Code Configuration	45
Electromagnetic Compatibility.....	46
Electromagnetic Compliance	46
Electromagnetic Emissions	46
Electromagnetic Immunity.....	47

General Information

Thank you for buying an Arjo product.

We are dedicated to serving your needs and providing the best products available along with training that will bring your staff maximum benefit from every Arjo product. Contact us if you need more information, want to report an unexpected event or need any help in setting up, using or maintaining Arjo product.

If a serious incident occurs in relation to this medical device, affecting the user, or the patient then the user or patient should report the serious incident to the medical device manufacturer or the distributor. In the European Union, the user should also report the serious incident to the Competent Authority in the member state where they are located.

All references to the patient in these instructions refer to the person being lifted, and references to the attendant refer to the person who operates the MAXI MOVE. Techniques described in these instructions for fitting slings and lifting patients from a reclining position can be used for patients regardless of where they may be lying; on the bed or on the floor.

Similarly, lifting a patient from a chair employs the same techniques as when lifting a patient from a wheelchair or from a sitting position on the edge of a bed.

NOTE: The need for a second attendant to support the patient must be assessed in each individual case.

These instructions specifically show both the clip attachment slings being used with the standard Dynamic Positioning System (DPS) and the loop attachment slings for loop spreader bars. The same methods and techniques described for the standard DPS can also be applied to the optional, powered DPS.

Definitions Used in this Manual

WARNING:

Means: Failure to understand and follow these instructions may result in injury to yourself and others.

CAUTION:

Means: Failure to follow these instructions may cause damage to the product(s).

NOTE:

Means: This is important information regarding the correct use of the equipment.

Manufacturer Information

ArjoHuntleigh AB
Hans Michelsensgatan 10
211 20 Malmö
SWEDEN

Intended Use

WARNING: To avoid injuries that can be attributed to the use of inadequate parts, Arjo strongly advises and warns that only Arjo designated parts should be used on equipment and other appliances supplied by Arjo. Unauthorised modifications on any Arjo equipment may affect its safety. Arjo will not be held responsible for any accidents, incidents or lack of performance that occur as a result of any unauthorised modification to its products.

MAXI MOVE is a mobile, passive lift with removable spreader bar.

Maxi Move is part of a series of quality products intended to assist caregivers in hospitals, long-term care, nursing homes and home care environments, including private homes where the patients/residents:

- sits in a wheelchair
- has no capacity to support himself/herself
- cannot stand unsupported and is not able to bear weight; not even partially
- is dependent on the caregiver in most situations.

Or where the patient:

- is passive
- might be almost or completely bedridden
- is often stiff or has contracted joints
- is totally dependent on the caregiver.

General Information

MAXI MOVE must always be handled by a trained caregiver and in accordance with the instructions outlined in this manual.

MAXI MOVE is intended to be used with Arjo slings. Only use slings and stretchers supplied by Arjo that are designed to be used with your MAXI MOVE.

MAXI MOVE is equipped with optional extra low height caster is not intended to be used on carpet.

Conditions

- The unit is cared for and serviced in accordance with recommended, published “Instruction for Use” and the “Preventive Maintenance Schedule”.
- The unit is maintained to the minimum requirements as published in the “Preventive Maintenance Schedule”.
- The servicing and product care, in accordance with Arjo requirements, must begin on first use of the unit by the customer.
- The equipment must be used for its intended purpose only and is operated within the published limitations. Only Arjo designated spare parts should be used.

Operational Life

- The expected operational life of your Arjo lift and its accessories is ten years from the date of manufacture, providing the following conditions are adhered to:
- The expected operational life for fabric slings and fabric stretchers is approximately two years from the date of purchase.
- This life expectancy only applies if the slings and stretchers have been cleaned, maintained and inspected in accordance with the “Arjo Sling Information” documents, the “Instruction for Use” and the “Preventive Maintenance Schedule”.
- The expected life for other consumable products, such as batteries, fuses, lamps, gel cushions, filters, seal kits, seat inserts, mattresses, safety belts, padded covers, straps and cords is dependent upon the care and usage of the equipment concerned.

Consumables must be maintained in accordance with published “Instruction for Use” and the “Preventive Maintenance Schedule”.

Policy on Number of Staff Members Required for Patient Transfer

Arjo’s passive and active series of lifts are designed for safe usage with one caregiver. There are circumstances, such as combativeness, obesity, contracture etc. of the individual that may dictate the need for a two-person transfer. It is the responsibility of each facility or medical professional to determine if a one or two-person transfer is more appropriate, based on the task, resident load, environment, capability, and skill level of the staff members.

Safety Instructions

Symbols Used

















General	Key to symbol
	This symbol is accompanied by a date (to indicate the date of manufacture) and by the address of the manufacturer.
	This symbol indicates that the products comply with the European Medical Device Regulation.
	CE marking indicating conformity with European Community harmonised legislation. Figures indicate Notified Body supervision.
	Metrology mark, indicating compliance with Directive 2014/31/EU (NAWI) - for scales manufactured after April 20th, 2016. (For Class III scales only) yy = year; XXXX = Notified Body number
	Indicates the product is a Medical Device according to EU Medical Device Regulation 2017/745.
	This symbol indicates NRTL certification through TÜV SÜD.
	This symbol indicates certification through TÜV SÜD.
	This symbol is accompanied by the manufacturer's catalogue number.
	This symbol is accompanied by the manufacturer's serial number.
	Waste Electrical and Electronic Equipment (WEEE) - do not dispose of this product in general household or commercial waste.
	These symbols refer to the <i>Instructions for Use</i> .
	This symbol indicates a type BF applied part.
	This symbol indicates a risk of pinching.
	This symbol represents a weight scale.
	This symbol indicates that the scale is a non-automatic instrument; accuracy class 3.
	Safe Working Load represents the maximum load for safe lifter operation.
	Maximum total mass of equipment including its safe working load.
Battery Charger Related	
Refer to the Wall Mounted Battery Charger - Instructions for Use 001-24257-**.	

Fig. 1

Safety Instructions

Before using your MAXI MOVE, familiarise yourself with the various parts and controls as shown in Fig. 3, and other illustrations. Then, read this manual thoroughly in its entirety before using your MAXI MOVE. Information in the manual is crucial to the proper operation and maintenance of the equipment, and will help protect your product and ensure that the equipment performs to your satisfaction. Some of the information in this booklet is important for your safety and must be read and understood to help prevent possible injury. If there is anything in the manual that you find is confusing or difficult to understand, please contact your local Arjo agent (the telephone number appears on the last page of this manual).

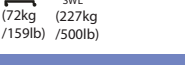
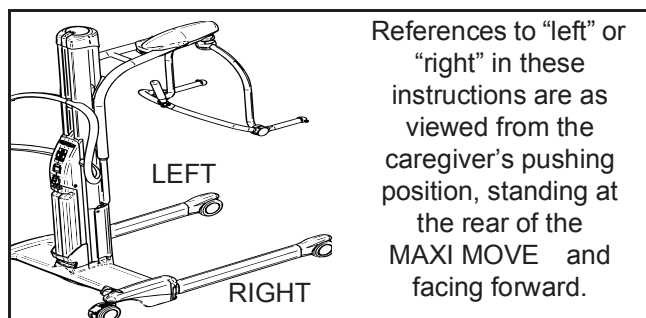

Fig. 2

This product has been designed and manufactured to provide you with trouble-free use. However, this product does contain components that are subject to wear with regular use.

CAUTION: Some of these parts are critical to ensure the safe operation of the lift. They will need examining and servicing on a regular basis and must be replaced as needed.

See also "Care of your MAXI MOVE" section.

CAUTION: Use only Arjo slings and stretchers that have been specifically designed for the MAXI MOVE.

WARNING: Before using the MAXI MOVE, a clinical assessment of the patient's suitability for transfer must be carried out by a qualified health professional considering that, among other things, the transfer may induce substantial pressure on the patient's body. A transfer conducted when it should not degrade the patient's health condition.

WARNING: Patients with spasms can be lifted, but great care should be taken to support the patient's legs to prevent fall risk and injuries.

WARNING: Do not overload the MAXI MOVE beyond the approved lifting capacity of the lowest rated attachment/accessory in order to avoid patient injury. If the maximum load differs between floor lift, spreader bar and body support unit (i.e. sling), then the lowest maximum load shall always be used.

Take care when manually lifting alternative/optional components such as stretcher frames, spreader bars etc., in order to avoid injury.

Do not attempt to manually lift the complete lift.

CAUTION: Although manufactured to a high standard, the MAXI MOVE and accessories should not be left in humid or wet areas.

Do not, under any circumstances, spray the MAXI MOVE or accessories (excluding slings or Arjo approved wet environment equipment) with water such as under the shower.

WARNING: Before lifting a patient it is advisable to familiarise yourself with and understand the operation of the various controls and features of the MAXI MOVE, and to carry out any action concerning inspection procedures.

The MAXI MOVE can be supplied with a variety of optional attachments, which are not all described in these instructions. If your MAXI MOVE has been equipped with an alternative/optional sub-assembly such as stretchers, etc., always refer to the separate, relevant operating instructions supplement, as well as these instructions, before you operate the lift.

This product is intended to be operated entirely by an attendant. The patient should not perform any function relating to the control of this product. A second attendant may be required with certain patients.

Homecare Environment Considerations

WARNING: The MAXI MOVE is not intended to be operated by children. Serious injuries could occur.

NOTE: Rigorous cleaning action should be done when the MAXI MOVE is exposed to an animal. Pet hair trapped inside the device can reduce the product performance.

WARNING: This product contains small parts that might present a severe danger to children if swallowed or inhaled.

Product Description/Functions

Parts Referred to in this Manual

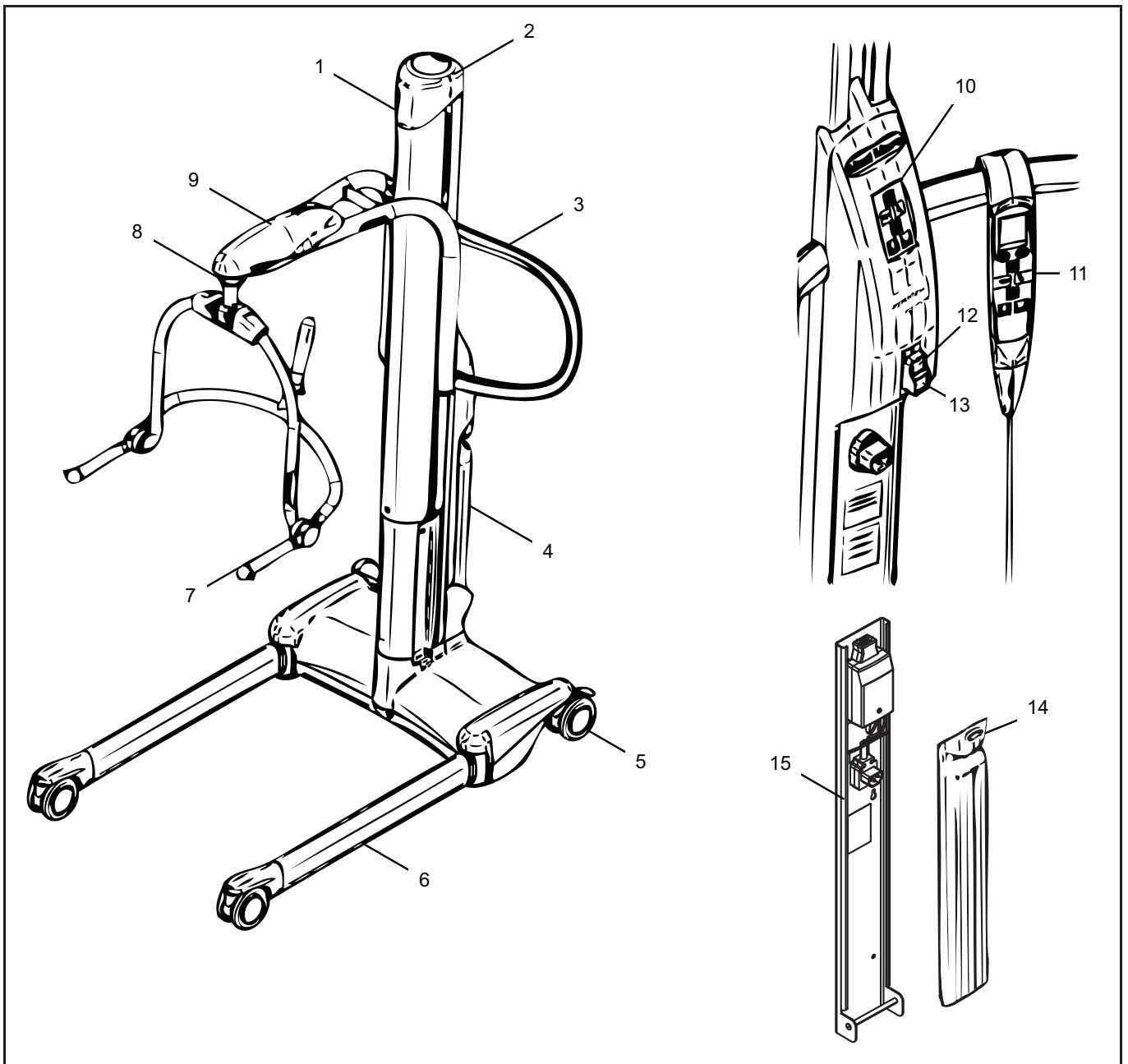

Fig. 3

- | | |
|--|--|
| 1) Mast | 12) Stop button |
| 2) Mast top cover | 13) Power button |
| 3) Maneuvering handle | 14) Battery release button |
| 4) Lift battery pack | 15) Battery charger |
| 5) Braked casters | 16) Two-point loop spreader bar (if included)* |
| 6) Adjustable chassis legs | 17) Loop medium Combi (if included)* |
| 7) Medium DPS spreader bar (if included)* | 18) Four-point loop spreader bar (if included)* |
| 8) "Lock and Load" spreader bar carrier system | 19) Small DPS spreader bar (if included)* |
| 9) Jib | 20) Medium powered DPS spreader bar (if included)* |
| 10) Control panel | 21) Large powered DPS spreader bar (if included)* |
| 11) Control handset | 22) Stretcher frame (if included)* |

* Refer to pages 10 and 11 for details.

Product Description/Functions

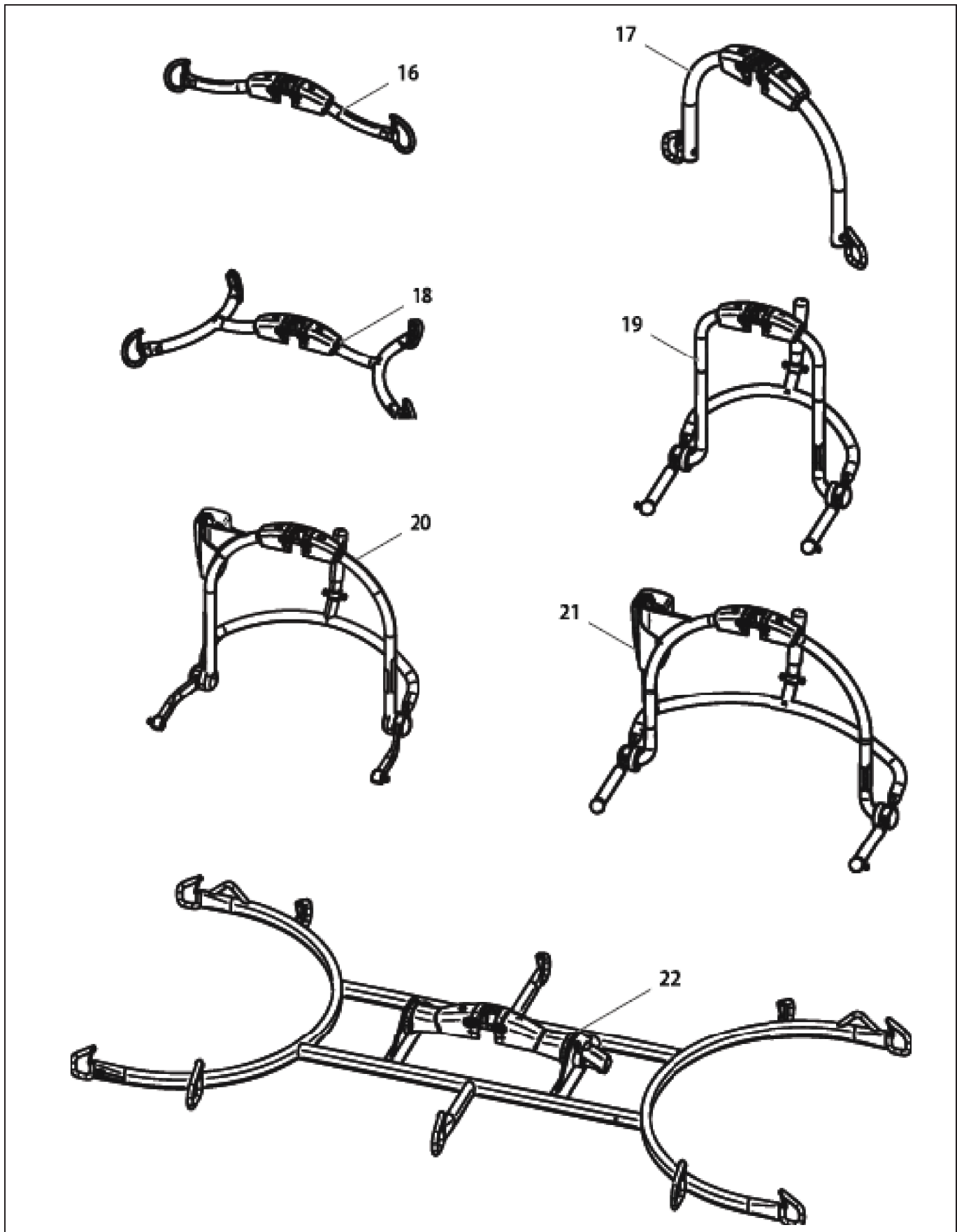

Fig. 4

Product Description/Functions

Name		Intended Use
7	Medium DPS spreader bar	Four points carry bar used for lifting a patient with a sling from sitting position to laying position using Arjo clip sling. Intended to be used with Arjo T-Bar attachment system.
16	Two-point loop spreader bar	Two points carry bar used to perform patient transfer from various position using Arjo loop sling. Intended to be installed on Arjo T-Bar attachment system
17	Loop medium Combi (700-19303)	
18	Four-point loop spreader bar (700-19331)	Four points carry bar used to perform patient transfer from various position using Arjo loop sling. Intended to be installed on Arjo T-Bar attachment system.
19	Small DPS spreader bar	Four points carry bar used for lifting a patient with a sling from sitting position to laying position using Arjo clip sling. Intended to be used with Arjo T-Bar attachment system.
20	Medium powered DPS spreader bar (700.19311)	
21	Large powered DPS spreader bar (700.19316)	
22	Stretcher frame	The foldable stretcher frame for Maxi Move is intended to be used for supine transfer in combination with a soft stretcher, a strap stretcher or a scoop stretcher

Fig. 5

Slings

The standard range of MAXI MOVE slings will support 227 kg (500 lb), the paediatric spreader bar range will support 125 kg (275 lb). All slings are size-coded with different coloured edge binding or attachment strap colouring:

Paediatric rated:

- Teal or Grey - Extra Extra Small - XXS
- Brown or White - Extra Small - XS
- Red - Small - S

Standard Range:

- Yellow - Medium - M
- Green -Large - L
- Purple - Large Large - LL
- Blue - Extra Large - XL
- Terracotta - Extra Extra Large - XXL

Always refer to the label on the sling being used to make sure of its actual safe working load (SWL).

A label is placed on the spreader bar for a quick colour-to-size reference (see the section entitled "Labels").

A range of special purpose slings is available as accessories. For these or for special size slings, contact your Arjo representative.

For more information on sling compatibility, use and installation, refer to Slings operating and Product Care Instructions (MAX81785M-INT).

WARNING: Only use Arjo supplied slings and stretchers that are designed to be used with MAXI MOVE to prevent fall risk and injuries. The sling profiles illustrated (see Fig. 5) will help to identify the various Arjo slings and fabric stretchers available.

If Arjo Flites (disposable slings) are to be used with your MAXI MOVE, always refer to the separate operating instructions for Arjo Flites (see respective sling IFU), as well as these instructions, before using.

WARNING: Arjo slings with head supports have two pockets located in the head section. These should contain plastic reinforcement inserts during use to avoid injuries. Always ensure that these reinforcement inserts have been placed inside the sling pockets before using the sling.

WARNING: Arjo warns of possible strangulation risks related to the use of slings. Necessary precautions should be taken to prevent these.

Product Description/Functions

Arjo standard sling profiles that can be used with the MAXI MOVE

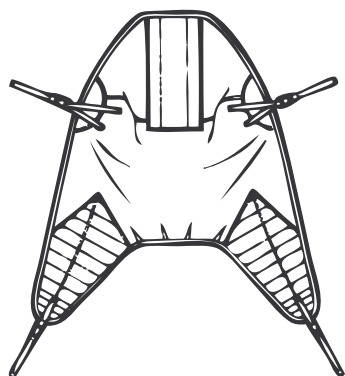

Four-point padded sling

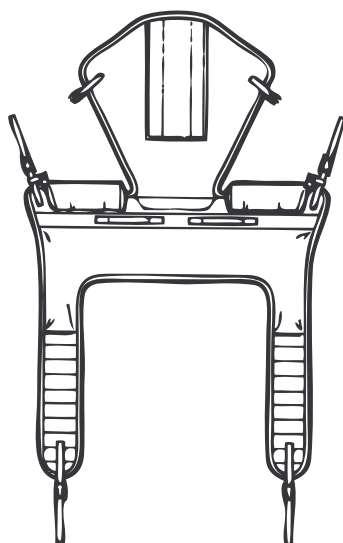

Four-point toileting sling

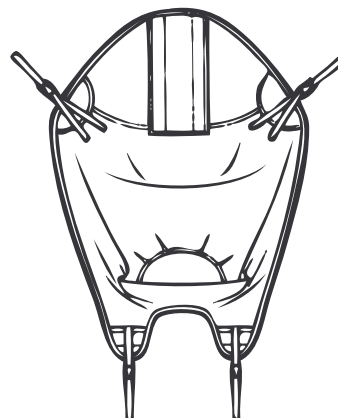

Four-point amputee sling

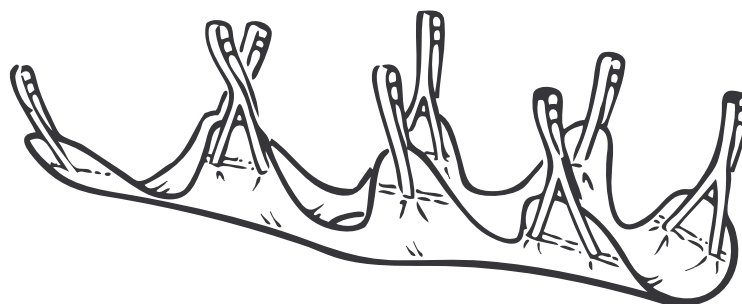

Soft stretcher

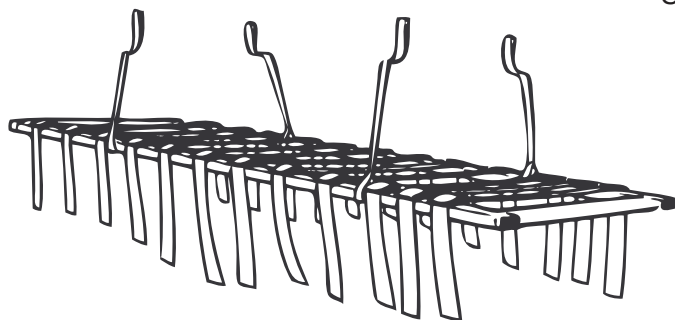

Strap stretcher
(refer to Arjo Strap Stretcher IFU)

**NOTE: Other sling models are available.
Contact your Arjo agent
for more information.**

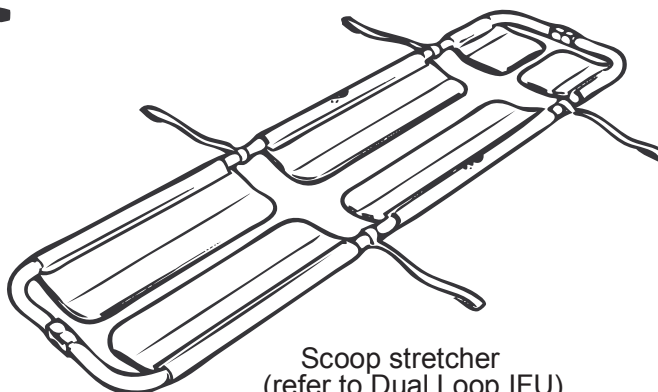

Scoop stretcher
(refer to Dual Loop IFU)

Fig. 6

Product Description/Functions

Controls and Features

Control Handset

(See Fig. 6) To raise and lower the jib, open and close the chassis legs, or to operate a powered DPS spreader bar, press the appropriate button on the control handset. Icons with direction arrows are printed on each button for quick reference.

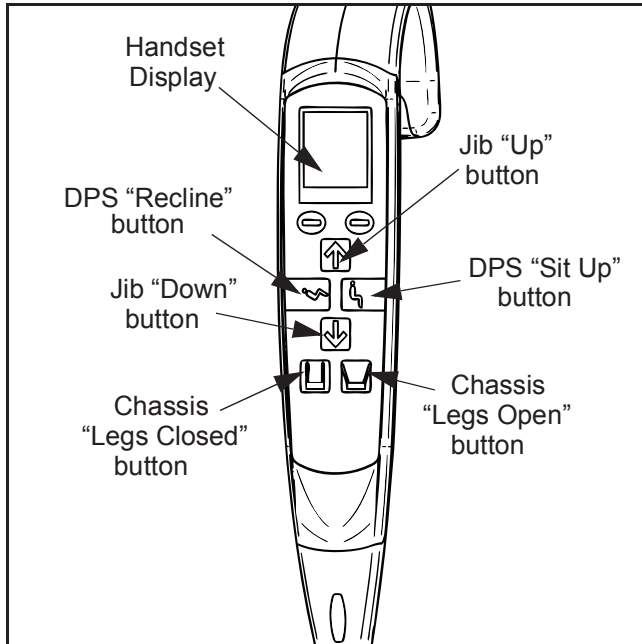

Fig. 7

If button is released during any function, powered motion will cease immediately. When not in use, the handset can be conveniently stored for later use by hooking it over the manoeuvring handle at the rear of the mast.

Control Panel

(See Fig. 7) An additional feature available on the MAXI MOVE, is a mast-mounted control panel, which operates in parallel with the control handset, enabling powered operations to be controlled from the lift mast as well as remotely by using the handset. As with the handset, icons with direction arrows are printed on each button for quick reference.

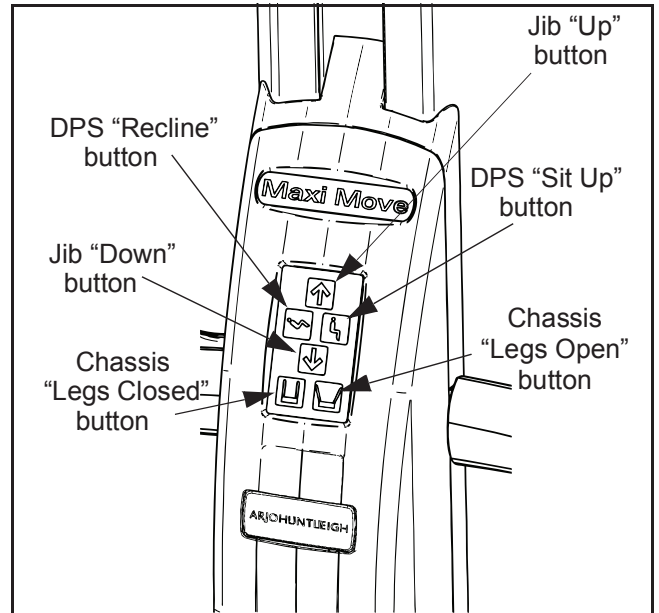

Fig. 8

Stop Button (red)

(See Fig. 8) In an emergency, if you have to immediately stop any powered movement (other than by releasing a control handset button or control panel button), press the stop button located on the control panel.

Once the stop button has been used, the green power button will have to be pressed before the equipment can be operated again. To do this, simply push in the button.

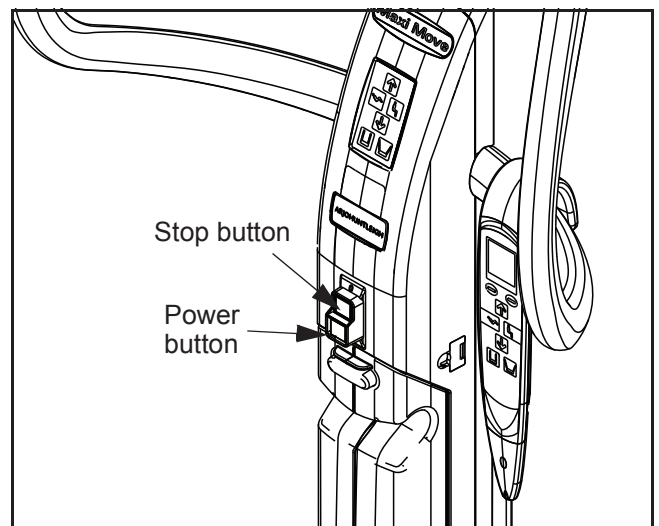

Fig. 9

Power Button (green)

(See Fig. 8) Located adjacent to the stop button, this button is used to turn the unit on.

Product Description/Functions

System Failure Wind Down Facility

If electrical power fails completely due to battery power loss or other electrical malfunction, the jib can be lowered by first raising the red-coloured emergency lowering lever found on the rear section of the mast (See Fig. 9).

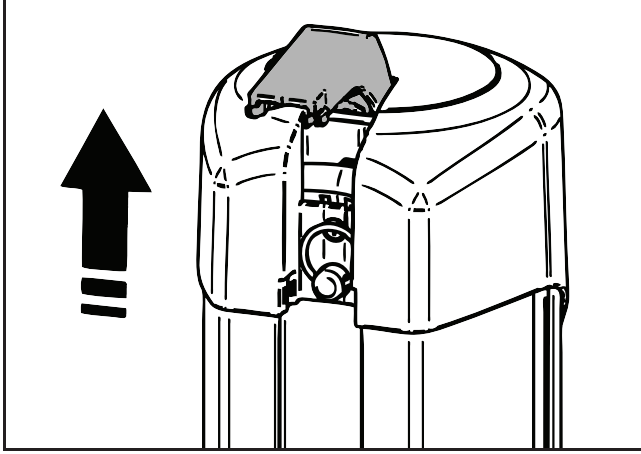

Fig. 10

Next, remove the exposed locking pin from its location beneath the red coloured emergency lowering lever (see Fig. 10).

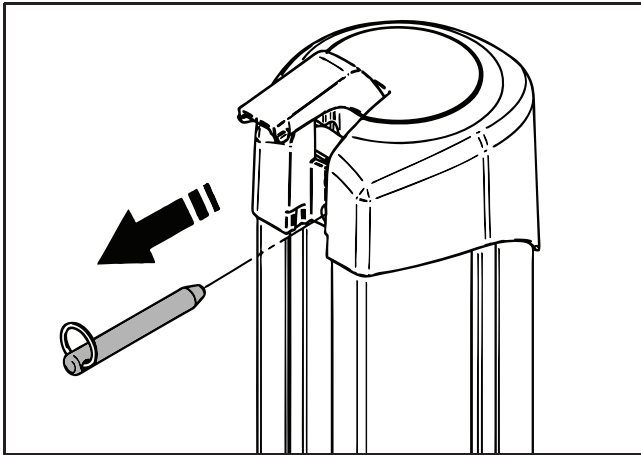

Fig. 11

Finally, using the lever as a crank, turn it in a clockwise rotation (see Fig. 11). One full clockwise rotation of the shaft lowers the mast jib by 10 mm (3/8 in).

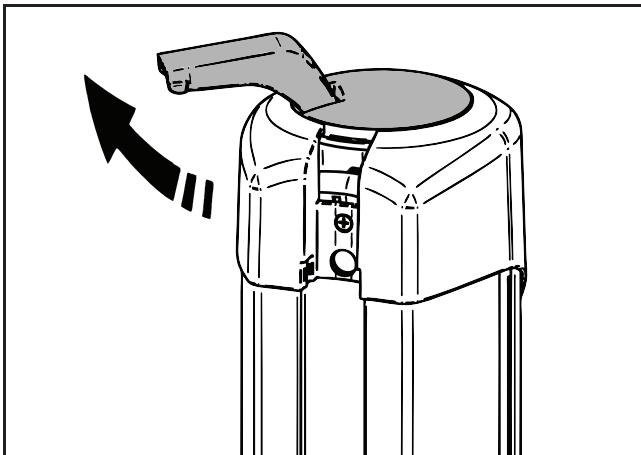

Fig. 12

WARNING: In order to prevent a fall risk and injuries, if the mast is in a high position and the wind-down function is used, ensure that suitable and safe measures are taken to gain access to the top cover.

If the wind down function must be used, immediately remove the lift from use and contact the Arjo Service Department or its appointed distributor.

Automatic Cut-Out

This is not an operator control but a function built into the lift's electronics.

If the lift is inadvertently overloaded by trying to raise or lower a load heavier than permitted, an automatic "cut-out" function operates to prevent the lift from raising a weight in excess of the safe working load (SWL). This will stop the lift's motion automatically.

If this occurs, release the jib "up" button on the handset or the control panel. Do not insist to raise the load. Make sure that the MAXI MOVE operates only within its safe working load.

Anti-Crush System

This is not an operator control but a function built into the lift's electronics.

Great care should be taken not to lower the spreader bar, or stretcher onto the patient or any other obstruction. If this should happen, the unit's "anti-crush" system will engage, stop the motor and all downward movement will cease. If this occurs, release the jib "down" button immediately and press the jib "up" button to raise the jib until the lift is clear. Then remove the obstruction.

Battery Indicator

The battery indicator for the MAXI MOVE is a feature found on the control handset. Please refer to the "Battery Charging" section for operating procedures.

Sleep Mode

The MAXI MOVE is equipped with a power-saving feature which places the machine in "sleep mode" when not used for a short time. The unit is put into sleep mode in two stages:

- 1) After two minutes of inactivity (where no buttons are pressed on either the control handset or control panel), the handset's display will go into sleep mode. The display can be taken out of sleep mode by pressing any button on the handset or the control panel. There will be a three second delay after which the unit is fully ready for use.
- 2) After six minutes of inactivity, the entire unit will be placed into sleep mode and will restart only when a button is pressed either on the control handset or control panel. There will be a three second delay after which the unit is fully ready for use.

Product Description/Functions

Usage Counter

The usage counter is a feature found on the control handset which shows the accumulated amount of time (in hours) that the lift's mast has been raised or lowered.

Initially, the display will show "0.0" at the very top of the screen (right above the larger digits for the scale), indicating 0 hours of use. The measurement will increase in increments of 0.1 whenever an additional six minutes have been accumulated. Note that the counter is recording only during the movement of the mast. Keeping the unit turned on, using the powered DPS or adjusting the width of the legs will not affect the usage counter.

The maintenance symbol serves as a reminder of the annual maintenance requirements for the product. It will appear on the handset display when the usage counter reaches 175 hours. This target represents the average time a lift will be used during one year. However, based on the use of the unit, the maintenance symbol can appear sooner or later than a year.

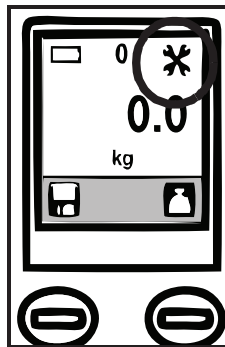

When the maintenance symbol appears, the unit will still be safe to use, but the annual maintenance should be performed as soon as it is reasonably possible.

The technician must reset the display to "0.0" when the annual inspection is performed to allow monitoring when the following inspection is due.

Adjustable Width Chassis Legs

(See Fig. 12) To open the chassis legs, press the "legs open" button on either the control handset or control panel. When the button is released, movement will stop and the chassis legs will remain securely in position. Always transfer patients with the chassis legs in the closed position.

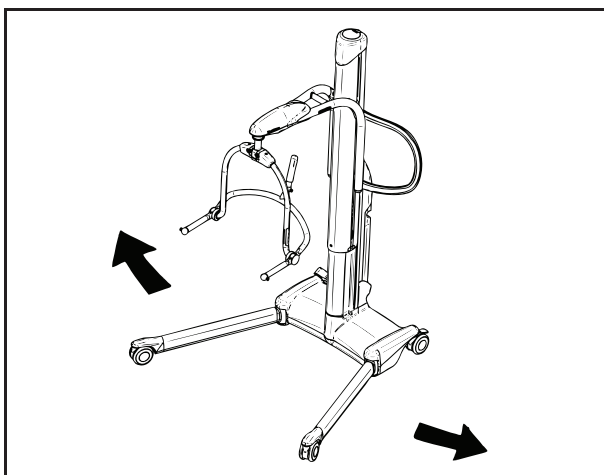

Fig. 13

Chassis Castor Brakes

(See Fig. 13) The chassis rear castors have brakes which can be foot operated to keep the MAXI MOVE in position.

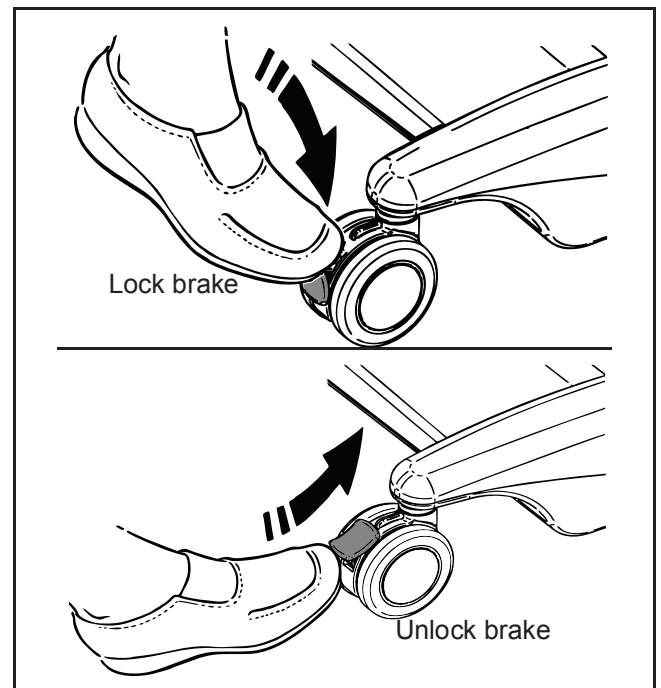

Fig. 14

Jib and Spreader Bars/Stretcher Frame

(Consult Fig. 3) Your MAXI MOVE is equipped with a quick connection device that allows you to use multiple attachments, such as loop/DPS spreader bars, stretcher frames, etc. See the section entitled "Using your MAXI MOVE" for full instructions on installing or changing attachments.

Using your MAXI MOVE

Before Approaching the Patient

Ensure that the battery pack supplied is fully charged before use (for recharging batteries, see the instructions in the “Battery Charging” section). When the battery pack is fully charged, remove it from the charger unit and insert it back into the MAXI MOVE. First, match the recess across the bottom of the battery pack with the protrusion at the bottom of the battery slot, then pivot the battery into position until the retaining catch engages. An electrical connection will be made automatically.

Ensure that the green power button (located below the control panel) is pushed in (see Fig. 8).

Ensure that a selection of sling types and sizes is available for all transfers likely to be performed using the MAXI MOVE.

The attendants should always tell the patient what they are going to do, and have the correct size sling ready. Whenever possible, always approach the patient from the front.

NOTE: To ensure the patient’s maximum comfort, do not allow the patient to hold on to the spreader bar or the jib.

WARNING: Before raising the mast make sure there is enough clearance above the MAXI MOVE to ensure the safety of the patient and the people around, and to avoid injuries. Be very careful when lifting next to a door frame.

WARNING: During displacement, always make sure there is enough clearance above the MAXI MOVE to ensure the safety of the patient and the people around, and to avoid injuries. Be very careful when passing through door openings.

If required, the chassis legs may be opened to go around a chair or wheelchair.

Powered Opening “V” Chassis

Push the “legs open” button on the control handset or control panel until the required width for the chassis legs is reached. To close, press the “legs closed” button. Movement will stop if the button is released, whether opening or closing.

When opening or closing the legs on a powered chassis, care must be taken not to allow anything to stand in the way of the chassis’ moving legs. For example, pay special attention when the legs are operated around chairs or in doorways. The lift must be moved only when the chassis legs are in the closed position.

MAXI MOVE ‘Lock and Load’ System

(See Fig. 14)

If you need to install or change the attachment, such as the spreader bar or stretcher frame, proceed as follows:

To remove the attachment: Hold it carefully and depress the locking clip thumb pads to release it from the T-bar (see Fig. 15A). Then, still pressing on the locking clip, lift the attachment up wards and away from the T-bar (see Fig. 15B and Fig. 15C), and store it carefully for future use.

To install an attachment: Select the attachment required and—while carefully handling it, with the locking clip thumb pads facing you—allow the recess in the attachment to fit around the T-bar shaft (see Fig. 15D). Ensure the attachment drops down over the T-bar and that the locking clip engages fully. (see Fig. 15).

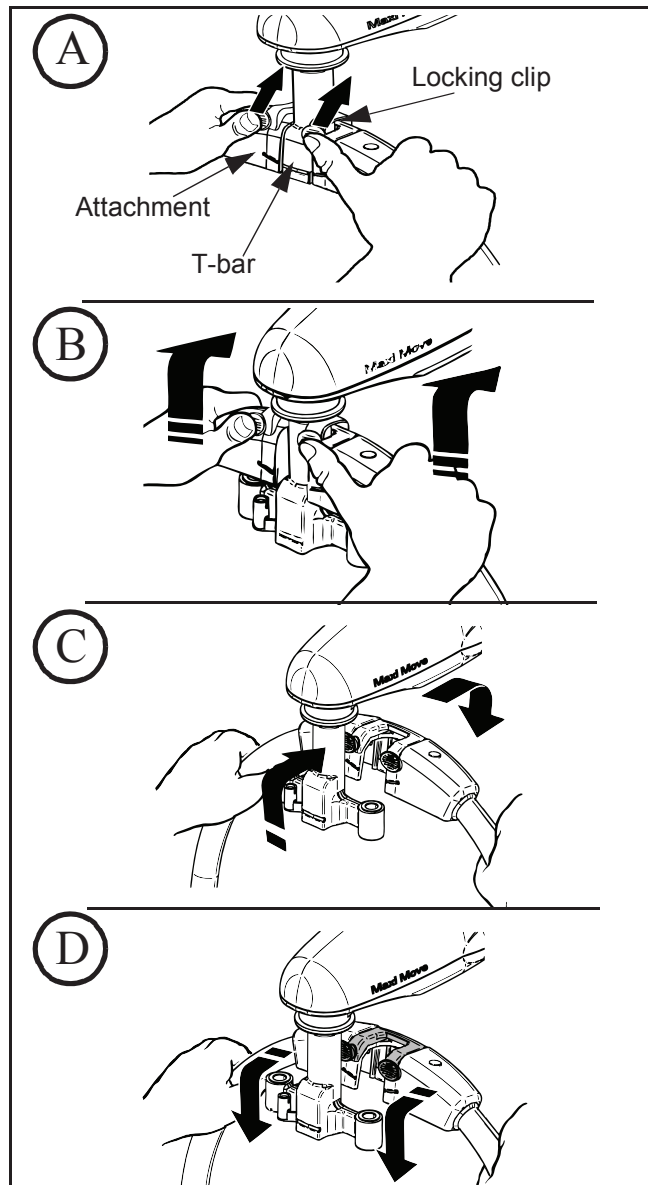

Fig. 15

WARNING: Be prepared to take the full weight of the attachment when removing it from the jib to prevent a back injury.

For larger attachments, or if there is any doubt about being able to lift and hold the attachment securely, use more than one person for the procedure, or support the attachment on a bed or chair.

Using your MAXI MOVE

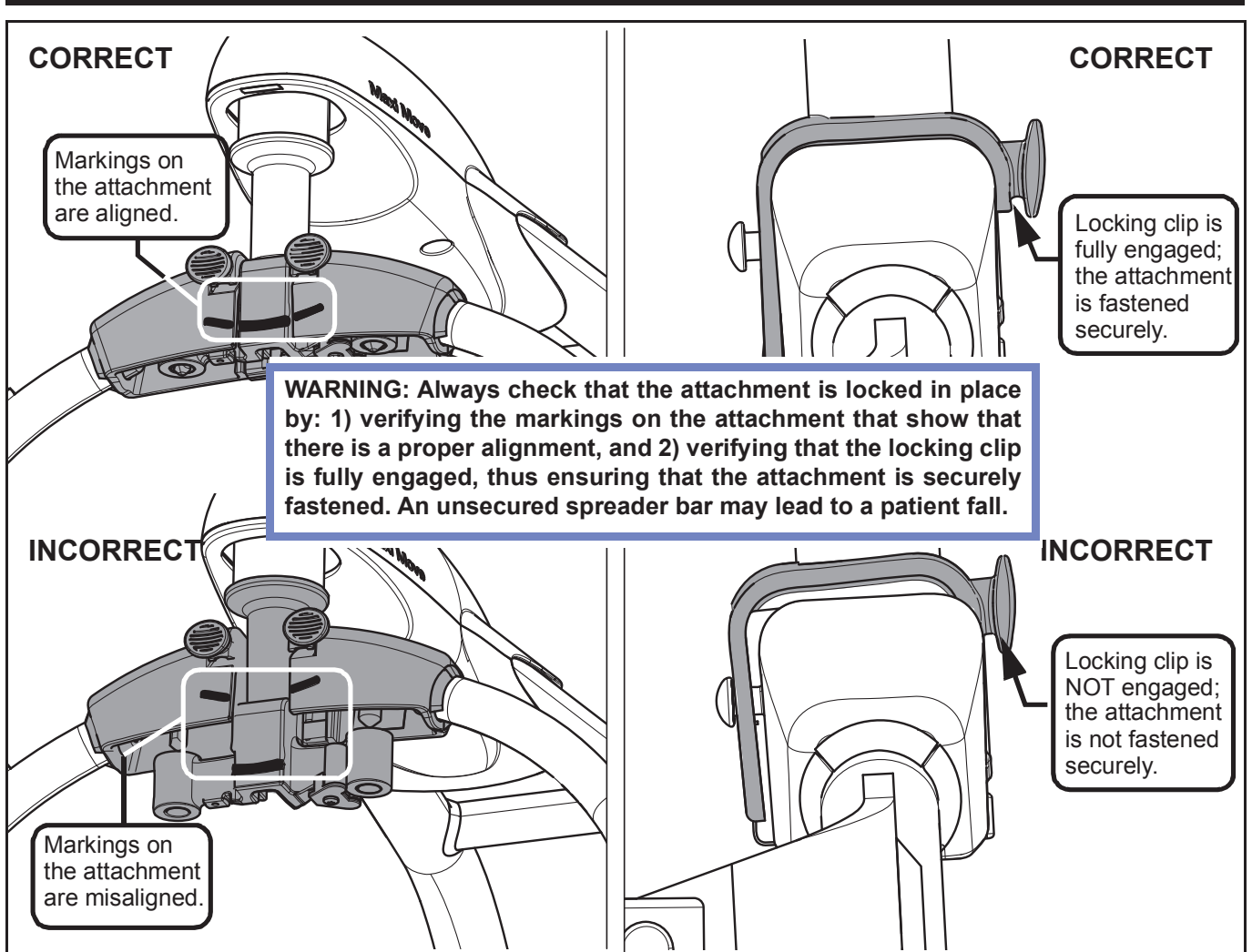

Fig. 16

WARNING: DO NOT lower the attachment onto rigid surfaces (e.g. bed, floor, wheelchair armrests, etc.), to avoid the possibility of the attachment becoming dislodged from the T-bar. A dislodged attachment may later detach completely from the unit, causing the patient to fall.

Testing the Attachment

To ensure that the attachment is safely connected and secured to the T-bar, hold the attachment firmly with both hands, without pushing on the locking clip thumb pads, and lift the attachment upwards firmly (see Fig. 16). If the attachment becomes dislodged from the T-bar, DO NOT use the MAXI MOVE. Contact your local Arjo agent.

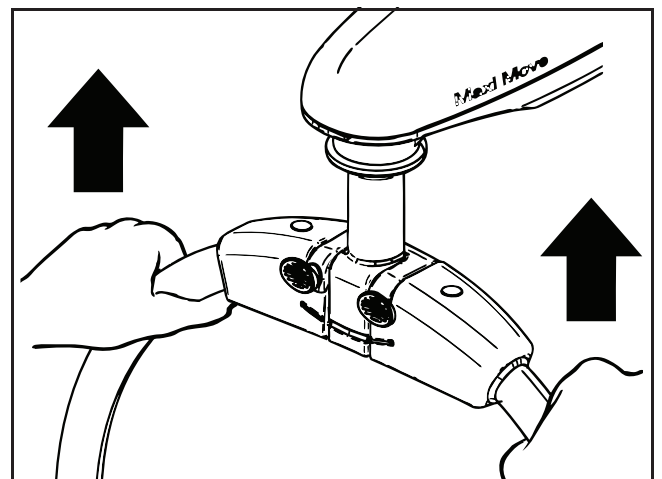

Fig. 17

WARNING: Always check that the attachment is locked in place by: 1) verifying the markings on the attachment that show that there is a proper alignment, and 2) verifying that the locking clip is fully engaged, thus ensuring that the attachment is securely fastened.

Using your MAXI MOVE

Using the DPS Spreader Bar

To Lift from a Chair

Place the sling around the patient so that the base of his/her spine is covered and the head support portion of the sling is behind the head. Pull each leg strap from under the thigh so that it emerges on the inside of the thigh (see Fig. 17).

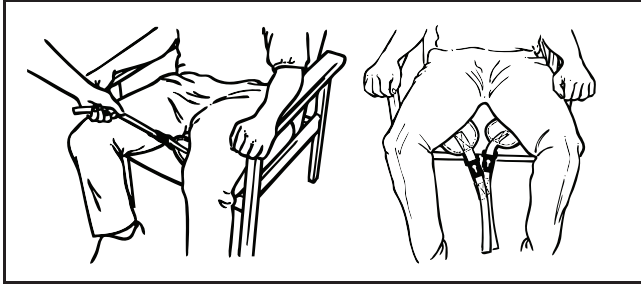

Fig. 18

Ensure the positioning handle on the spreader bar is facing away from the patient, and that the open part of the spreader bar is at or just below shoulder level (see Fig. 18).

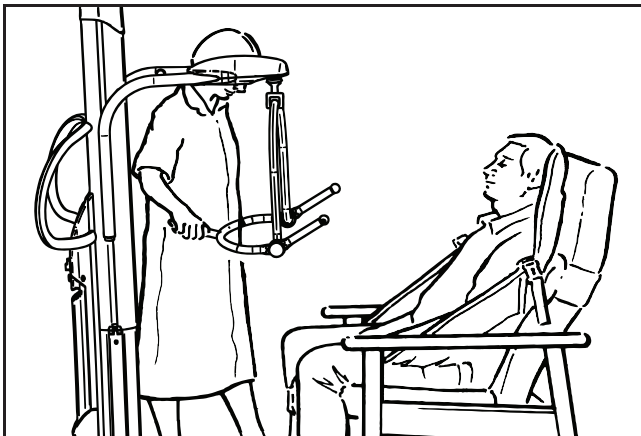

Fig. 19

Ensure that the MAXI MOVE is close enough to be able to attach the sling's shoulder clips to the spreader bar. To accomplish this you may have to put the patient's feet on, or over, the chassis.

WARNING: When installing and lifting using the sling with the DPS spreader bar, ensure that the patient's hands and arms are kept inside the sling at all times to prevent injuries. Do not allow the patient to hold on to the spreader bar.

Once the MAXI MOVE is in position, attach the shoulder strap attachment clips to the sling attachment lugs on the spreader bar (see Fig. 19).

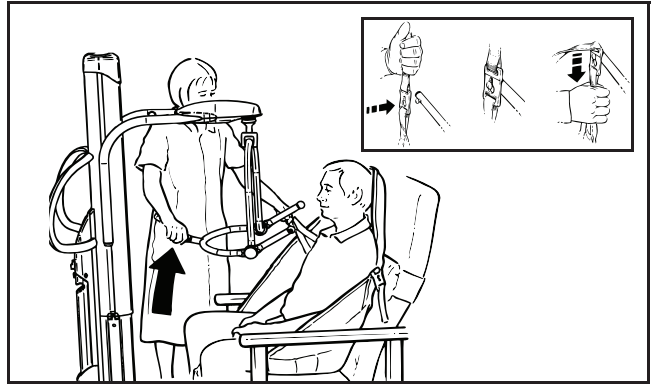

Fig. 20

CAUTION: The chassis rear castors have brakes which can be foot-operated when required (see Fig. 13). Do not apply the chassis brakes at this stage, as the position of the patient will adjust to the centre of gravity of the lift while the patient is being raised.

Press down on the positioning handle on the spreader bar and attach the leg strap attachment clips (see Fig. 20).

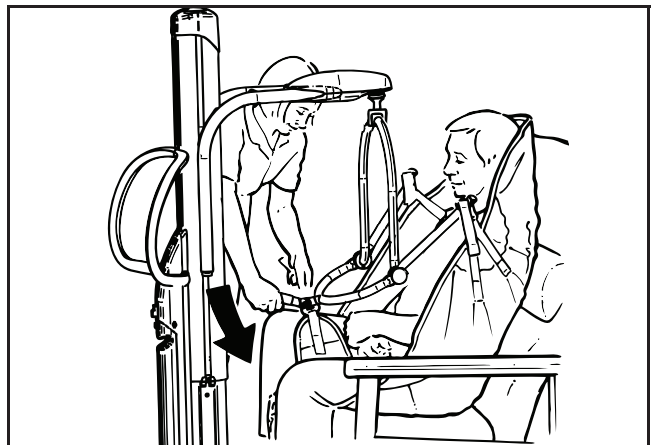

Fig. 21

For most residents, the straight attachment of the leg clips is recommended use (see Fig. 21).

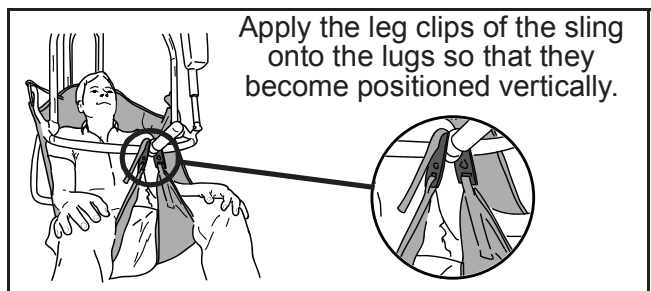

Fig. 22

Using your MAXI MOVE

If the resident is prone to kicking off the leg clip, the crossed attachment of the leg clips shall be applied, which will prohibit the clip from being kicked off (see Fig. 22).

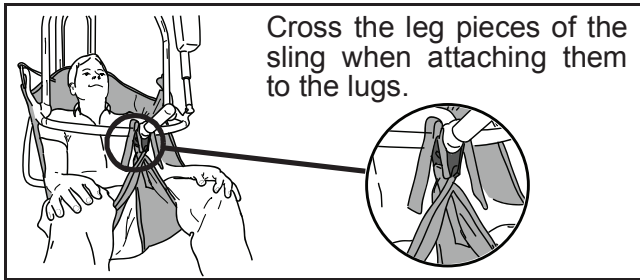

Fig. 23

If necessary, lower the spreader bar using the handset control, being careful not to lower it onto the patient. If this should happen inadvertently, there is a built-in cut-out device which will prevent any further downward movement. Do not continue to push the handset “jib down” button.

If the handset button is released during the lifting or lowering procedure, powered motion will stop immediately.

When lifting from a chair, some attendants prefer to connect the leg straps first. This applies in particular to patients with large thighs. In that case, press down on the position handle on the spreader bar and attach leg strap attachment clips. Then tilt the spreader bar towards the shoulders to connect the shoulder attachment clips.

CAUTION: Always check that all the sling attachment clips are fully in position before and during the lifting cycle, and in tension as the patient’s weight is gradually taken up.

Before transferring, position the patient to face the attendant at approximately the height of a normal chair. This provides a measure of confidence and dignity to the patient. Remember to release the brakes if they have been applied, before transferring the patient.

Lift the patient using the handset control, and adjust to a comfortable position for transfer (see Fig. 23). The specially designed sling, together with its integral head support, enables one person to carry out the complete lifting function without additional help.

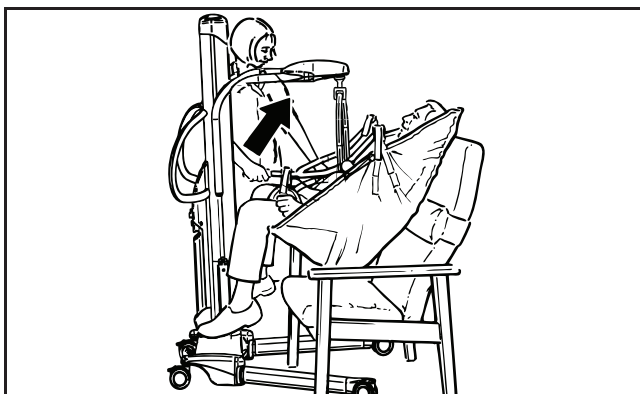

Fig. 24

Move the lift away from the chair. The angle of recline can be adjusted for more comfort with restless patients. The lift can now be directed towards the next transfer point (see Fig. 24).

WARNING: Do not attempt to move the lift by pulling or pushing on the mast, the jib, the spreader bar or the patient as this can cause the lift to topple over, and cause injuries. Always use the manoeuvring handle when displacing the lift.

WARNING: When lowering the spreader bar, ensure that the patient’s and attendant’s legs and feet are well clear of any parts of the lift in order to avoid patient injuries and/or damage to the Maxi Move. Only detach the sling leg connection clips followed by the shoulder connection clips when the patient’s body weight is fully supported by the bed.

WARNING: Always make sure there is enough clearance around the patient or the device during the transfer to prevent any impact.

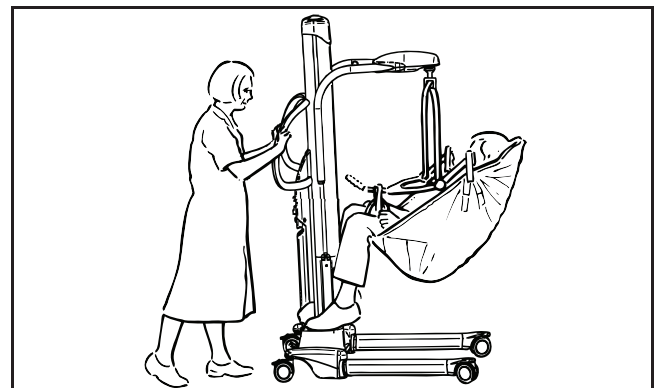

Fig. 25

When lowering the patient back down, lower the positioning handle to put the patient into a sitting position. This avoids further lifting strain. Take care not to push down too quickly, as this may jerk the patient’s head forward.

To Lift from the Bed

Before lifting a person from a bed, ensure there is sufficient clearance underneath the bed to accommodate the MAXI MOVE chassis legs. Position the patient onto the sling by rolling the patient towards you, then folding the sling in half and placing it behind the patient’s back (see Fig. 25).

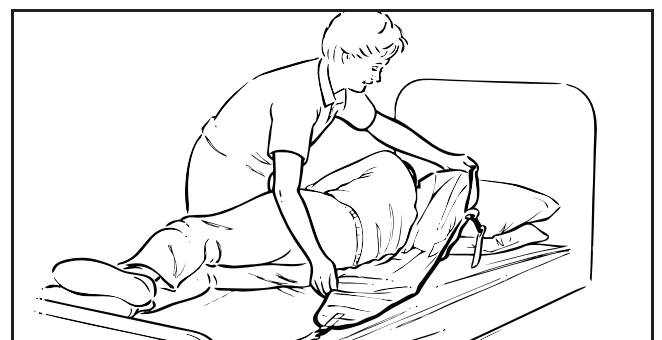

Fig. 26

Using your MAXI MOVE

Position the sling carefully so that, when rolled back, the patient will lie on the centre of the sling (see Fig. 26). Check that the head support area of the sling covers the patient's neck.

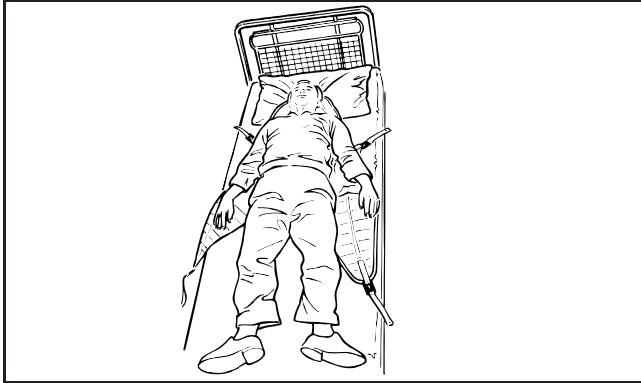

Fig. 27

When rolling the patient back onto the sling, roll the patient slightly in the opposite direction so that the folded part of the sling can be pulled forward.

Alternatively, the patient can be brought into a sitting posture. Then position the sling as detailed in the section entitled "To Lift From A Chair".

Approach the bed with the open side of the spreader bar towards the patient's head (see Fig. 27).

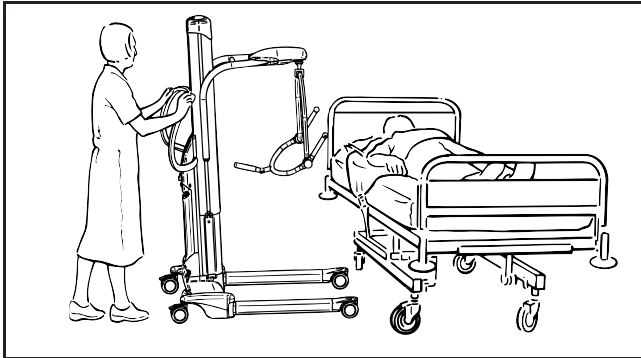

Fig. 28

Using the adjustable width chassis, it is possible to make adjustments to the chassis leg width to assist with manoeuvrability around obstructions, such as bed legs or castors.

Now position the MAXI MOVE so that the spreader bar is just above and centred over the patient.

WARNING: Take care not to lower the spreader bar onto the patient to avoid injuries.

Using the positioning handle, tilt the spreader bar until the shoulder attachment points can be connected to the sling shoulder strap attachment clips (see Fig. 28)

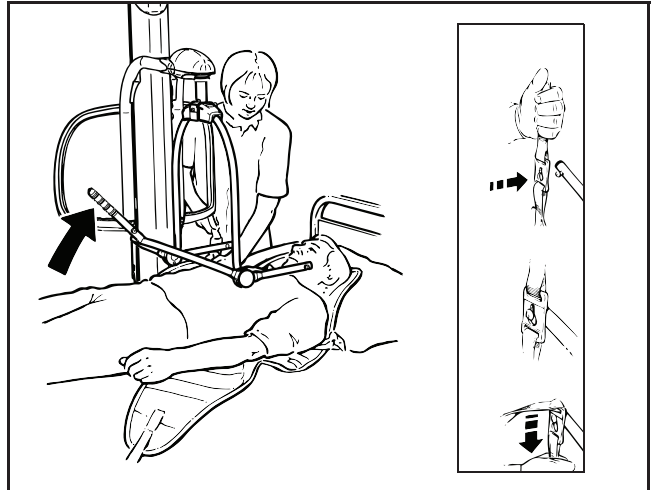

Fig. 29

Press down on the positioning handle until the sling leg sections can be connected (see Fig. 29). Connect the leg sections under the thighs by lifting one leg at a time. You may need to lower the spreader bar a little, using the handset control.

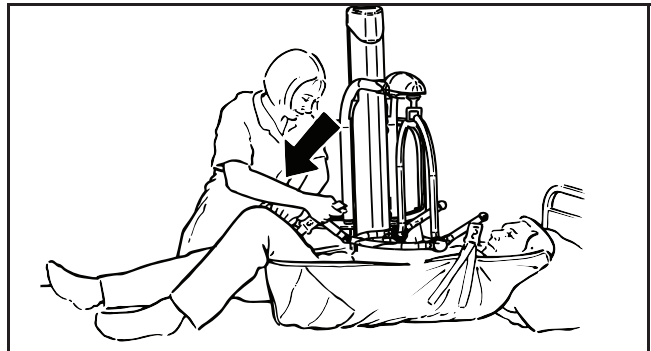

Fig. 30

When lifting from the bed, some attendants prefer to connect the leg straps first. This applies in particular to patients with large thighs. In that case, raise the hip and knee into maximum flexion, and attach the leg strap attachment clips. Then tilt the spreader bar towards the shoulders to connect the shoulder attachment clips.

CAUTION: Always check that all the sling attachment clips are fully in position before and during the lifting cycle, and in tension as the patient's weight is gradually taken up.

Lift the patient using the handset control, and with the positioning handle, bring the patient into a comfortable position for transfer (see Fig. 30). The specially designed sling, together with its integral head support, enables one person to carry out the complete lifting function without additional help.

Using your MAXI MOVE

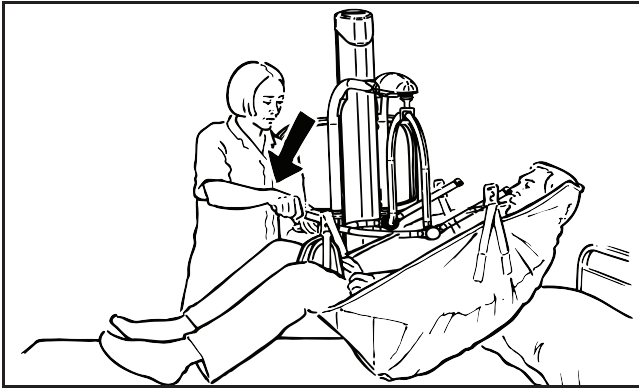

Fig. 31

If returning the patient to a bed, move into the desired position above the bed, adjusting the spreader bar position as necessary. Then lower the patient using the handset control.

When lowering the spreader bar, ensure that the patient's and attendant's legs and feet are well clear of any parts of the lift to avoid injuries.

WARNING: Only detach the sling leg connection clips followed by the shoulder connection clips when the patient's body weight is fully supported by the bed to avoid any risk of fall.

Pull the MAXI MOVE away before removing the sling from under the patient. If transferring the patient to a chair, refer to the section entitled "To Lift from a Chair".

To Lift from the Floor

Put the sling around the patient, by rolling or sitting the patient up. Open the chassis legs first, then approach and lift the patient's legs over the chassis as shown in Fig. 31.

CAUTION: Make sure that no strap is passing under the MAXI MOVE legs.

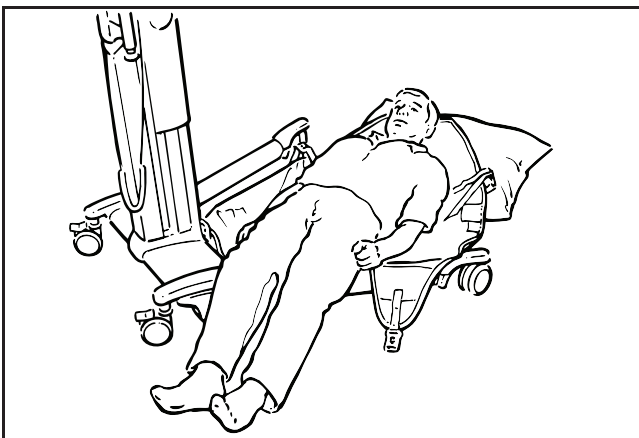

Fig. 32

CAUTION: While the patient is positioned over the legs as shown in Fig. 31, DO NOT operate the adjustable chassis leg controls.

When connecting the sling to the spreader bar, the patient's head and shoulders could be raised with pillows for additional comfort.

With the open part of the spreader bar pointing down towards the shoulders, attach the shoulder strap attachment clips, as shown in Fig. 32 and inset.

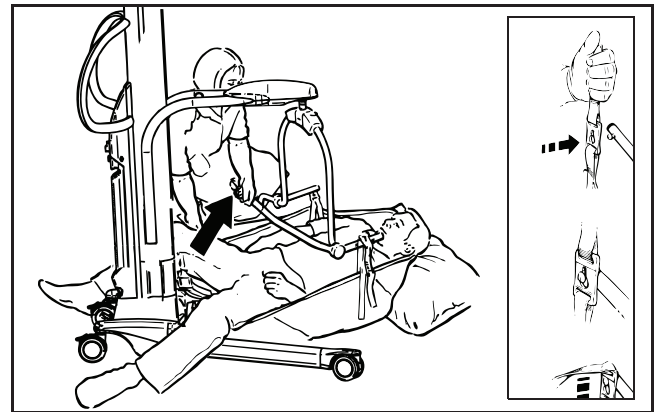

Fig. 33

Once connected, raise the hip and knee into maximum flexion, and push down on the positioning handle to be able to connect the leg strap attachment clips as shown in Fig. 33. This will have the effect of raising the patient's head and shoulders slightly.

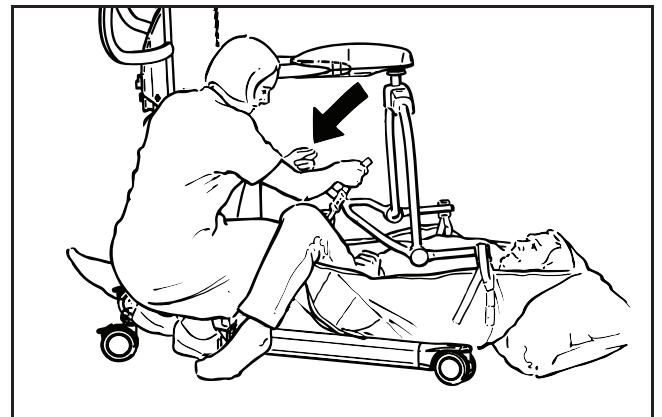

Fig. 34

CAUTION: Always check that all the sling attachment clips are fully in position before and during the lifting cycle, and in tension as the patient's weight is gradually taken up.

When lifting from the floor, some attendants prefer to connect the leg straps first. This applies in particular to very large patients with large thighs. In that case, raise the hip and knee into maximum flexion, and attach the leg strap attachment clips. Then tilt the spreader bar towards the shoulders to connect the shoulder attachment clips.

When all the straps are securely attached, lift the patient from the floor in a semi-reclining position. Supporting the head can add comfort and can reassure the patient. Once raised from the floor, ensure the patient's legs are clear of the chassis before continuing to lift (see Fig. 34).

Using your MAXI MOVE

The leg portions of the sling will tend to be fairly high in the patient's crotch area. Straighten them out for added comfort. The patient may then be positioned in a chair, or placed on a bed. Patients with extensor spasms may be lifted by the MAXI MOVE, but care should be taken to support the patient's legs during the beginning of the lift.

WARNING: When lowering the spreader bar, ensure that the patient's and attendant's legs and feet are well clear of any parts of the lift to avoid injuries.

Only detach the sling leg connection clips followed by the shoulder connection clips when the patient's body weight is fully supported by the bed.

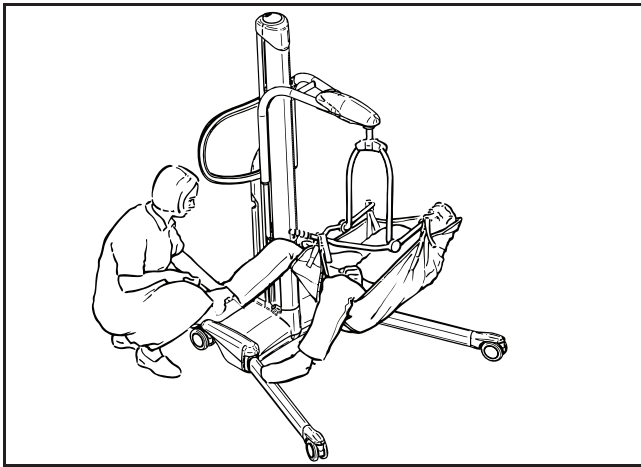

Fig. 35

When lifting patients with leg amputations, use the double amputee sling (available as an accessory from Arjo). This sling is specially designed to accommodate each patient's centre of gravity.

The transferring of patients should always be done with the chassis legs closed. Manoeuvrability will be easier, especially through doorways. As usual, the patient should be positioned facing the attendant.

Powered DPS Spreader Bar

If your lift has been supplied equipped with a powered DPS spreader bar (see Fig. 35), the use of this type of spreader bar—including sling positioning with patients, sling connection to the spreader bar, and patient handling—is the same as the manual DPS spreader bar described previously in these instructions.

WARNING: Before using your lift equipped with the powered DPS spreader bar, familiarise yourself with the various parts as illustrated in Fig. 36. Read and thoroughly understand these operating instructions in order to avoid mistakes that could result in injury.

The powered DPS spreader bar must be used in accordance with the following instructions and in conjunction with the operating instructions previously described for the manual DPS spreader bar.

The lifting capacity of the lift, when equipped with the powered DPS spreader bar remains the same as the manual DPS spreader Bar.

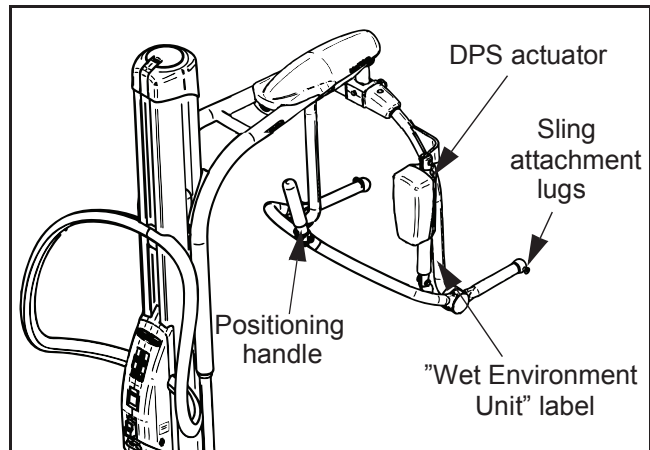

Fig. 36

The fundamental difference is that the powered DPS spreader bar has the added advantage of enabling the patient positioning manoeuvre to be performed with minimal physical effort by the attendant.

The rotation of the powered DPS spreader bar is manual and is the same as the manual DPS spreader bar.

The powered DPS is classified by Arjo as a wet environment unit. A blue and white circular label is attached to show this. This label signifies that anything above its position must not be soaked in water, either when bathing or showering the patient.

To operate the powered patient positioning function, ensure that the green power button is pushed in (see Fig. 8).

When ready to perform the patient positioning function (as described previously), operate the powered DPS control buttons on the handset (see Fig. 6) or the buttons found on the control panel to cause the spreader bar to move in the required position.

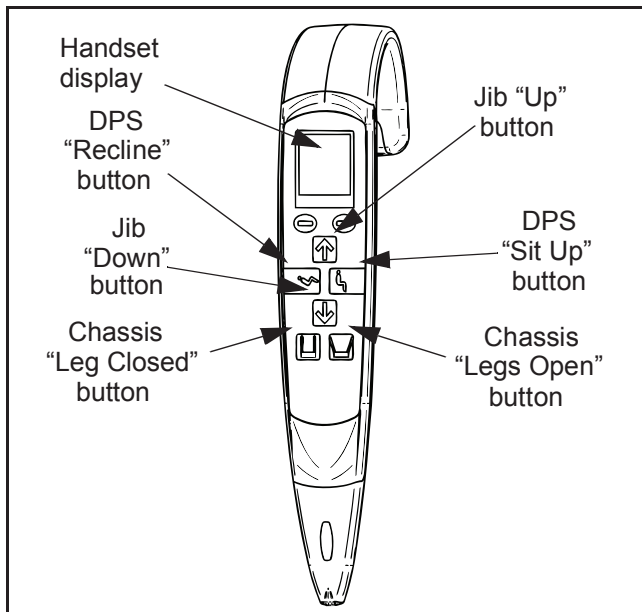

Fig. 37

To stop any powered movement, release the control button or press the stop button.

The spreader bar will remain firmly in position, once powered movement has stopped.

Always ensure the spreader bar is securely connected to the jib before starting to lift.

CAUTION: Before and during operation of the powered DPS spreader bar, ensure all obstructions are clear of the spreader bar, support frame and jib.

Care of Your Powered DPS Spreader Bar

For general care, refer to the section entitled "Care of your MAXI MOVE". Refer in particular to the paragraphs on cleaning plastic parts, labels, etc.

CAUTION: The DPS actuator contains moving parts. Take care not to damage it. Should the covers become damaged, do not use the lift and replace the actuator before reusing the lift.

Using the Loop Spreader Bar

If your MAXI MOVE has a loop spreader bar, ensure that the spreader bar is rotated into position before attaching the sling, so the eventual lift will resemble Fig. 37.

When attaching a loop sling to the loop spreader bar, always ensure that the sling attachment loops are installed correctly into the retaining hooks (see Fig. 38).

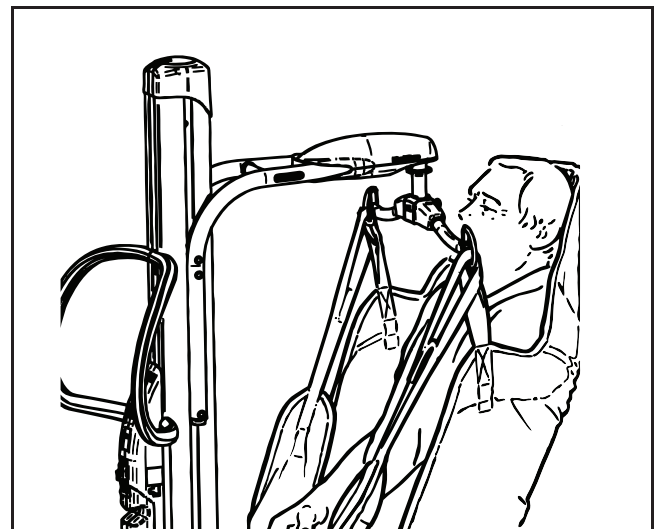

Fig. 38

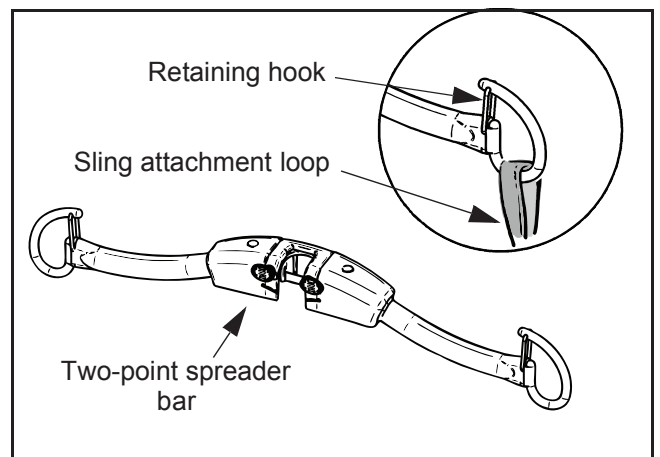

Fig. 39

Use Arjo loop slings with the loop spreader bar (consult Fig. 4). They are available in four color-coded sizes (small, medium, large and extra-large). For details on a more specialised range of slings, please contact Arjo or its authorised distributors.

The loop slings are available with or without a head support. A mesh sling is also available in all four sizes, with or without a head support.

Using your MAXI MOVE

To Lift from a Chair

First, ease the patient forward if necessary. Slide the sling down the patient's back until seam "C" reaches the base of the spine (see Fig. 39).

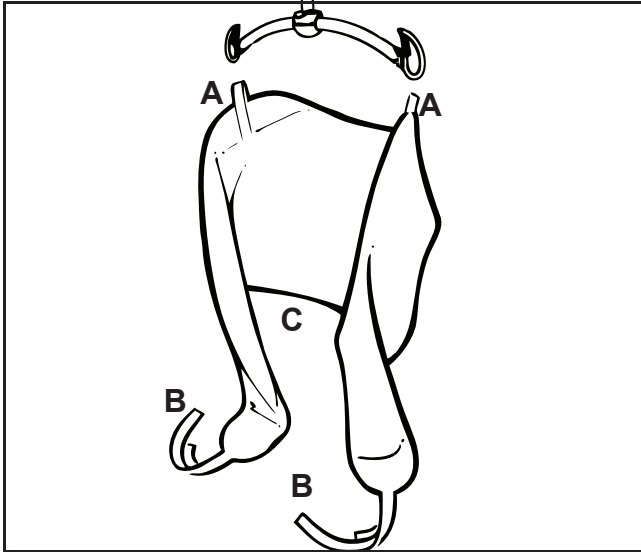

Fig. 40

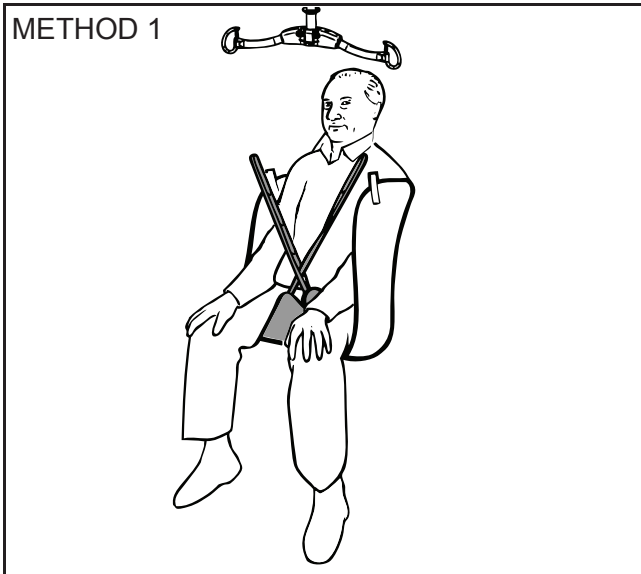

Fig. 41

Method 1 - Bring attachment loops "B" and the leg sections of the sling underneath the patient's thighs. Ensure that the leg sections of the sling are not twisted underneath the patient. Hook the attachment loops onto the hooks on the opposing side of the spreader bar (see Fig. 40 above).

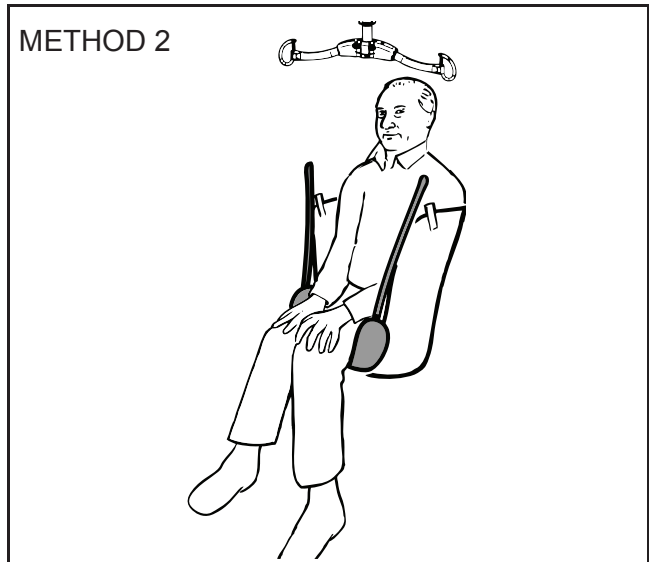

Fig. 42

Method 2 - As in Method 1, but pass each leg section of the sling under both thighs and then out the other side before attaching points "B" to the hooks on the opposing side of the spreader bar (see Fig. 41 above).

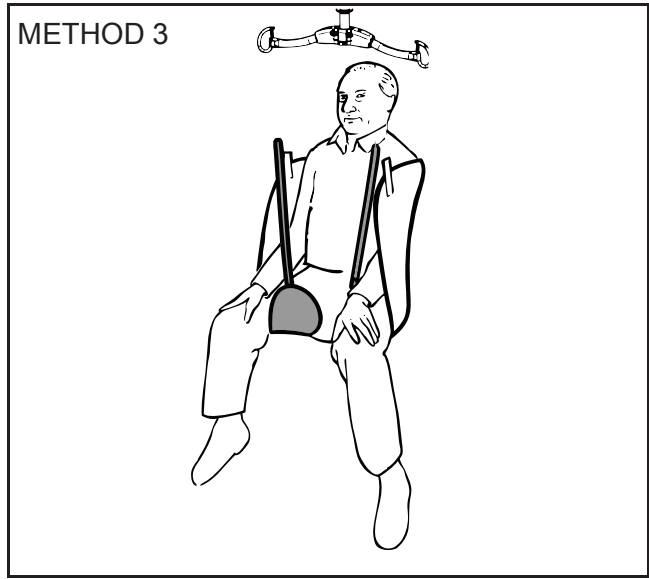

Fig. 43

Method 3 - As in Method 1, but loop a leg portion of the sling under each thigh and attach to the same side hook as the shoulder attachment (left straps to left hook and right straps to right hook). This method holds the legs in abduction and is useful for toileting (see Fig. 42 above).

WARNING: To prevent a fall risk, always check that all the sling attachment loops are fully in position before and during the lifting cycle, and in tension as the patient's weight is gradually taken up.

When lowering, ensure that both the patient's and attendant's legs and feet are well clear of the moving mast to avoid injuries.

Using your MAXI MOVE

Once the sling has been positioned and attached securely to the spreader bar, the patient can be lifted using the control handset. For general patient manoeuvring and transferring, see also the section entitled "Using DPS Spreader Bar".

Apart from the methods listed above, the Loop spreader bar with loop slings is also extremely useful for lifting patients who have "contracted legs", which prohibit the use of the DPS spreader bar. Attach the sling as described in the section entitled "To lift from the Bed".

To Lift from the Bed

Place the sling under the patient as if it were a sheet. Flex the patient's legs and bring the sling leg sections under the thighs. Attach the sling to the spreader bar using any of Methods 1-3 above.

CAUTION: Check that all four points of the sling are securely connected before lifting.

To lift from the Floor

NOTE: Some attendants prefer to use a larger sling for this operation.

Raise and support the patient into a sitting or half-sitting position. Feed the sling down along the patient's back. Bring the leg portions of the sling into position. Raise the patient's legs over the chassis, and bring the lift into position (see Fig. 43). With the jib as low as possible, attach the shoulder loops. Bend up the patient's knees to connect up the leg portions of the sling.

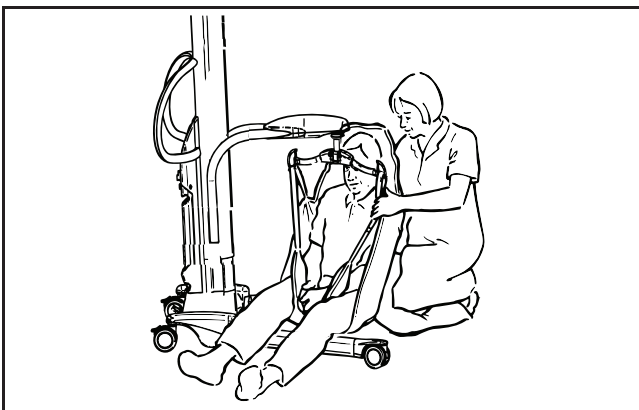

Fig. 44

CAUTION: Check that all the loops are securely attached before lifting.

When lifting or lowering a patient who is supported by a sling, do not use the castor brakes. This allows the lift to move to the correct position using the patient's centre of gravity.

When the patient has been returned to the bed, the patient may be laid down before the sling is detached.

WARNING: When lowering the spreader bar, ensure that both the patient's and attendant's legs and feet are well clear of the moving mast to avoid injuries.

Using the Stretcher Frame

WARNING: To avoid tipping when using the lift with a stretcher, transfers must only be performed on flat, non-sloping surfaces/floors. Also, always make sure that the patient is positioned in the middle of the stretcher.

The stretcher frame has been designed to aid portability without removing the stretcher frame from the lift, such as for going through doorways.

WARNING: Do not raise or lower the patient while the stretcher frame is being used to transfer a patient to avoid injuries.

WARNING: Never use Stretcher Frame with a Maxi Move equipped with extended jib. Also make sure to respect SWL rating of Stretcher Frame, as indicated on the accessory itself.

Using the Soft Stretcher

The soft stretcher is intended for use with the stretcher frame and is available in two sizes: large and extra-large. It is also supplied in both plain polyester or polyester mesh for washing. Both types are available with or without commode hole. Use the following procedure to lift a patient using the stretcher frame and soft stretcher.

CAUTION: Before the soft stretcher can be used with the MAXI MOVE, ensure the Arjo stretcher frame has been correctly installed on the carrier (see Fig. 14). Once correctly installed, the stretcher frame should be able to rotate approximately 90° around its axis. Do not install the stretcher frame in line with the jib.

Identify the head section of the soft stretcher. Look for a label sewn to the end of the head section.

Position the soft stretcher sling by rolling the patient over as if inserting a sheet. Ensure that the top section of the sling (as indicated by the label attached to the sling) is under the patient's head, with the top edge of the sling level with the top of the head (see Fig. 44). With the stretcher frame as high up as possible, move the lift until the frame is directly over the patient.

Using your MAXI MOVE

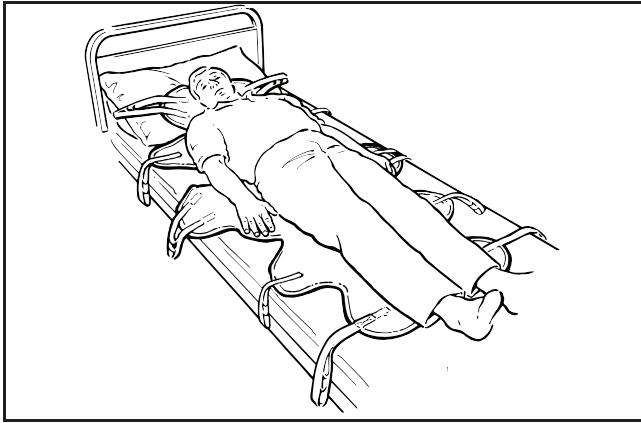

Fig. 45

The frame is symmetrical and can be used from either side (see Fig. 45).

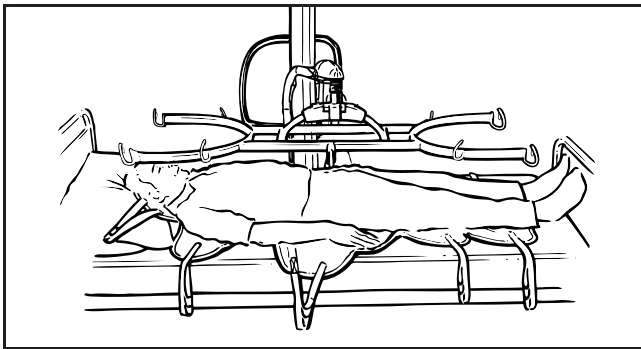

Fig. 46

Lower the stretcher frame carefully over and just clear of the patient, aligning the centre of the frame approximately over the patient's navel. Connect all the sling loops securely (see Fig. 46).

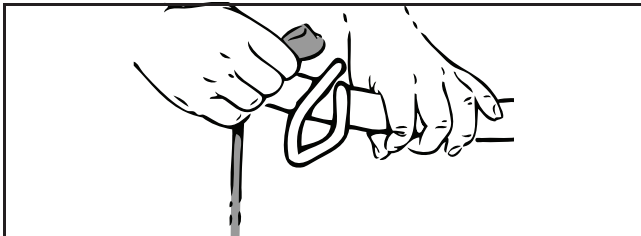

Fig. 47

NOTE: The attachment straps have several connection loops. Choose whichever loop is considered the best to enable the patient to lie in the most comfortable position.

WARNING: It is essential to keep the patient at approximately the height of the bed to ensure stability of the unit and to maintain patient/attendant contact.

When lowering the stretcher frame, ensure that the patient's and attendant's legs and feet are well clear of the moving mast in order to avoid injuries and maintain the unit's stability.

Raise and move the patient away from the bed (see Fig. 47).

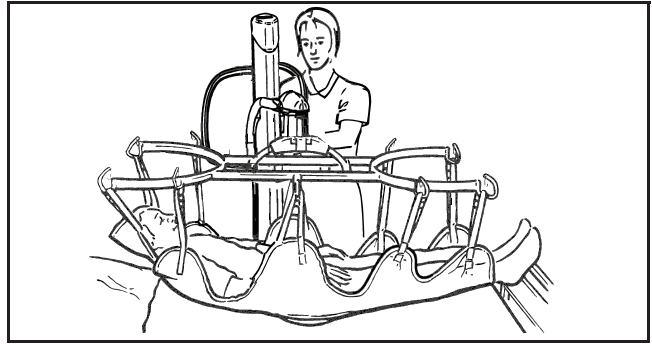

Fig. 48

Rotate the stretcher frame until the patient's feet are close to the mast (see Fig. 48). In this position, the complete unit may be moved through wide doorways. Otherwise, leave the stretcher perpendicular to chassis legs. In this position, the lift and patient can be moved through a doorway sideways.

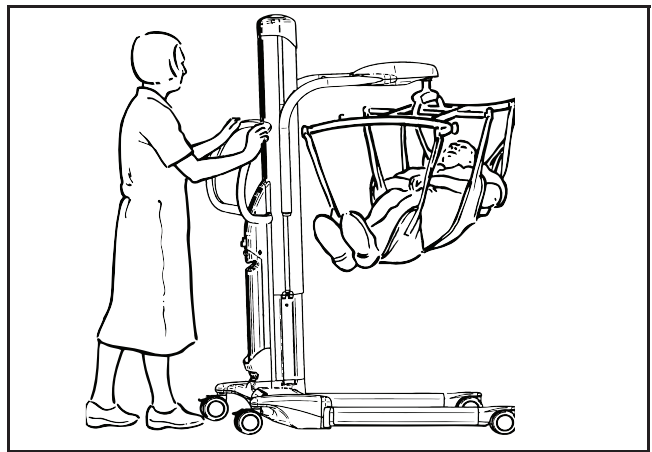

Fig. 49

WARNING: Only use soft stretchers that have all blue coloured attachment straps to prevent patient discomfort or a fall risk.

Note: The "head end" straps have a black tab stitched to them that can be used with other Arjo stretcher frames.

Do not use any other type of soft stretcher sling with the MAXI MOVE.

Page intentionally left blank

Scale

Patient Scale Information

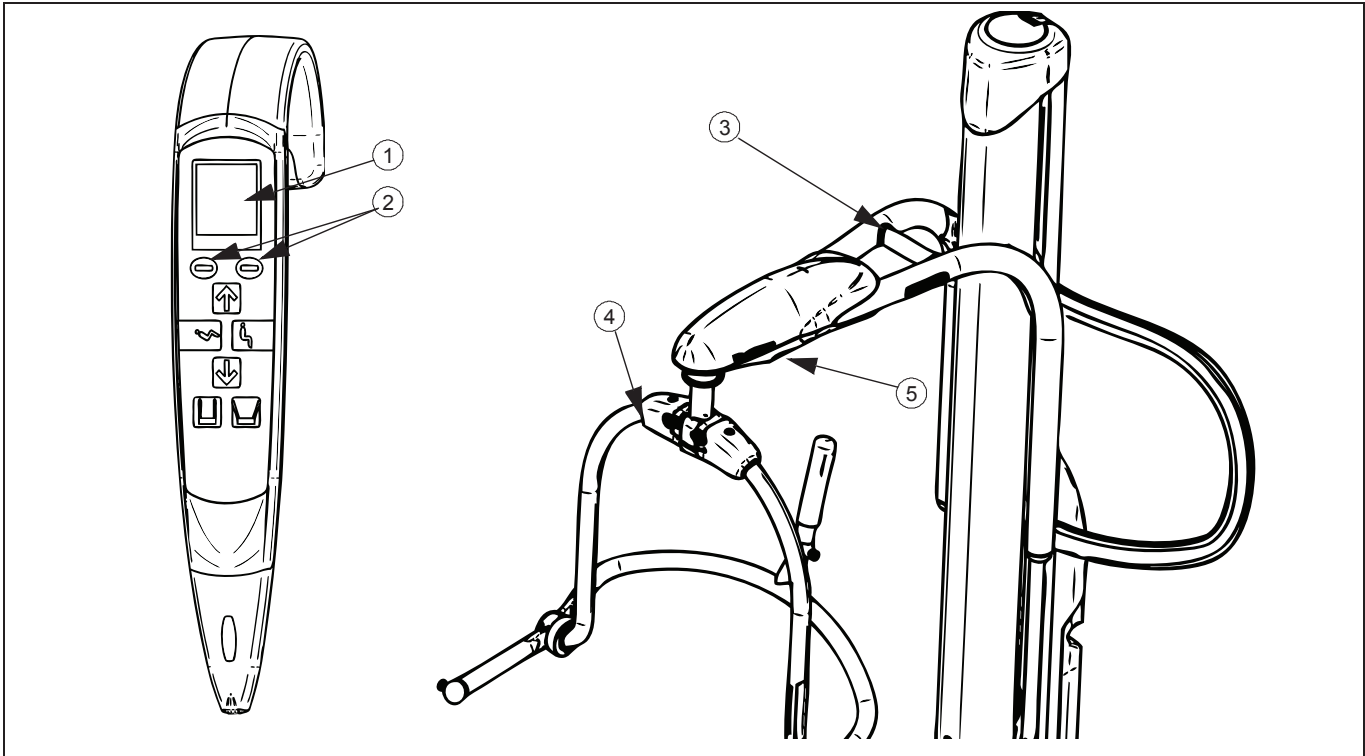

Fig. 50

Key to Scale (Fig. 57)

- 1) Scale display on handset
- 2) Operating buttons on handset
- 3) Jib
- 4) Spreader bar
- 5) Load cell cover

WARNING: The scale has been designed to weigh hospital or care facility patients under the supervision of trained nursing staff. Avoid any other uses to avoid injuries.

If your MAXI MOVE has been equipped with an Arjo scale, your lift will have the added advantage of being able to weigh patients once they have been lifted.

Descriptive Marking/Seals C.E. Units only

After inspection, the following marks will be found on the scale label (see Fig. 58):

- CE mark (indicating conformity with European Community harmonised legislation, followed by the two digits of the year in which it was affixed). (See Fig. 1)
- The identification number of the notified body that has carried out the EU surveillance.
- The number of the EU type approval certificate.
- The accuracy class.
- The maximum capacity.
- The minimum capacity

- Verification scale interval.
- Calibration counter
- Gravity configuration counter
- A seal bearing the identification and number of the inspection body.

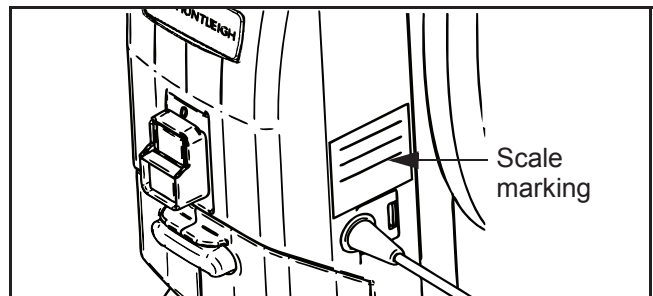

Fig. 51

Reinspection

Reinspection of approved weight scales must be carried out in accordance with the rules stipulated by local authorities (as specified by each country).

If the seals are broken such as during repair or replacement of the load cell, then the entire floor lift must be disqualified and not used again until a reinspection has been carried out by a certified inspection body.

Display Symbols/Functions

The handset has an LCD which displays various numbers and symbols.

The LCD screen can display weight in pounds or in kilograms.

The minus sign (-) shows when the weight is negative (see the section “Method B - Weighing With the Patient Already Suspended in the Sling”).

The scale can also display weight in Gross Weight and Net Weight modes.

Additional features include the battery charge indicator and preventative maintenance indicators.

Overload Warning Symbol

When the load is above the scale’s safe working load (SWL), the scale will display alternating large and small weight pictogramme (see Scale User Manual).

This warning is displayed according to the following weight limits:

- For the Standard jib: Load exceeding 227.9 kg
- For the Extended jib: Load exceeding 130.9 kg

If the scale is overloaded, remove the load immediately. Do not move the scale/lift until the symbol is switched off.

CAUTION: Do not overload the scale. If the scale unit displays alternating large and small images of the scale symbol, lower the patient immediately onto a bed or into a chair.

NOTE: FOR EUROPEAN SCALES ONLY, If the display shows the larger “TILT” symbol alternating with the scale symbol, relocate the MAXI MOVE to a level position so that the scale can be operated correctly (see Fig. 59).

NOTE: It is normal that the display occasionally shows a “Tilt” pictogram when the lift is being moved or manipulated.

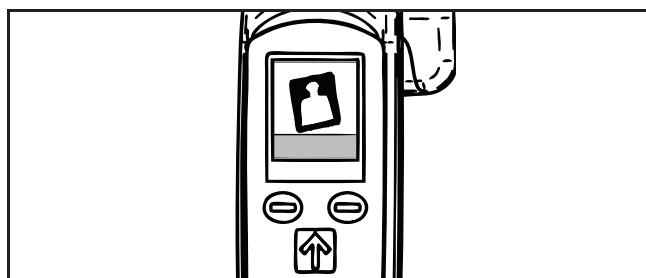

Fig. 52

CAUTION: Do not touch or lean on the patient, jib or spreader bar during the weighing operation. Ensure that no part of the patient, sling or spreader bar touches the mast or jib during weighing, as the jib and spreader bar are integral parts of the weighing equipment.

WARNING: To avoid injuries, if the patient is agitated, the attendant should wait until the patient calms down before attempting to weigh.

Gross weight refers to the zero weight reference at power up. Net weight is defined as the value of a load determined by the “tare” function, that allows to set the scale’s display to zero when the load is suspended on the jib.

There are two methods for weighing the patient:

CAUTION: The unit must be stationary on a flat levelled surface when it is powered up to allow the scale to perform an automatic zero reset.

Do not manipulate the lift or any of its components until the scale displays “0.0”. Failure to do so may result in inaccurate reading of the scale.

Method A - Weighing Before the Patient is Suspended in the Sling

- 1) Turn on the MAXI MOVE by pressing the power button.
- 2) If the sling has already been installed on the spreader bar at start-up, the MAXI MOVE has already zeroed automatically and taken the weight of the sling into account (see Fig. 60).

Move ahead to step 4.

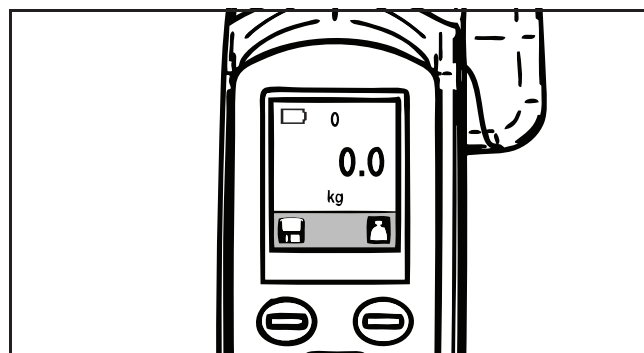

Fig. 53

If the sling was not already hung on the lift at start-up, install the sling. The scale will now show the weight of the sling on the screen (see Fig. 61).

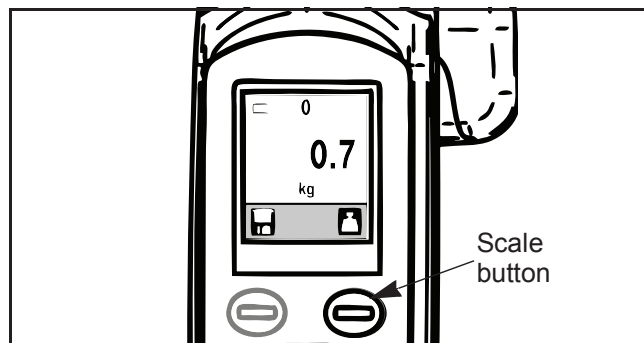

Fig. 54

- 3) Press the “scale” button to zero the scale. Now the display will show a zero weight (see Fig. 62).

Scale

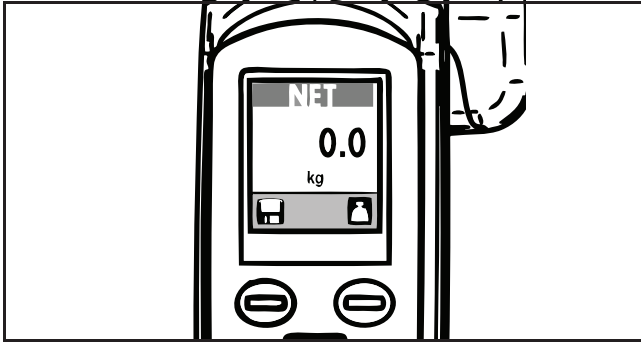

Fig. 55

- 4) Lift the patient until obstructions are cleared, such as the bed, chairs, the floor, etc. Allow the weight reading to stabilise.

Do not press the button again; the number displayed will be the patient's weight (see Fig. 63).

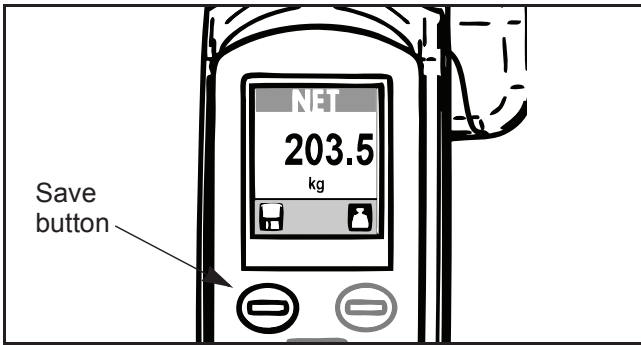

Fig. 56

- 5) Press the save button if the net weight needs to be kept in memory. Horizontal bars will appear above and below the digits on the screen to show that the save function is activated. "Save" will stay active until the save button is pressed again (see Fig. 64).

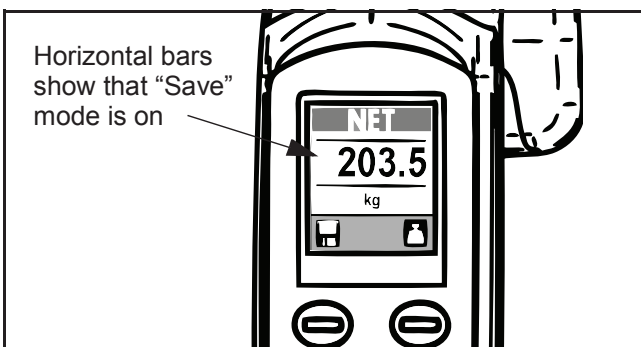

Fig. 57

Method B - Weighing with the Patient Already Suspended in the Sling

If the patient is already on the lift, and a weight measurement is needed, ensure that the patient is suspended free and clear of any obstructions such as the bed, chairs, the floor, etc.

- 1) Press the scale button to obtain a zero reading on the display (see Fig. 65).

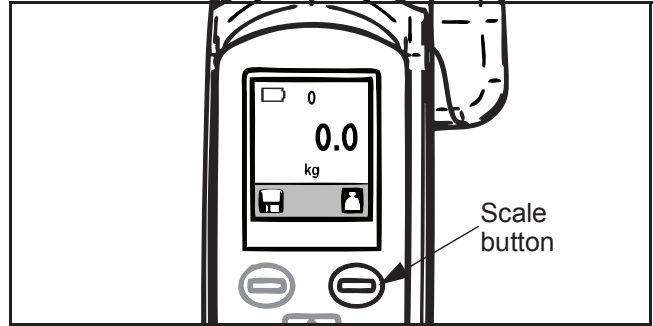

Fig. 58

- 2) Complete the transfer of the patient and remove the patient from the lift. The scale will display a negative number (see Fig. 66).

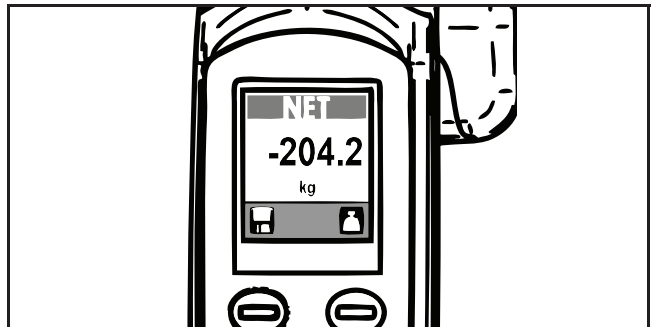

Fig. 59

- 3) Reinstall the sling back on the MAXI MOVE. Ignore the minus sign preceding the digits on the screen. Allow the weight reading to stabilise. The weight shown is the patient's actual weight (see Fig. 67).

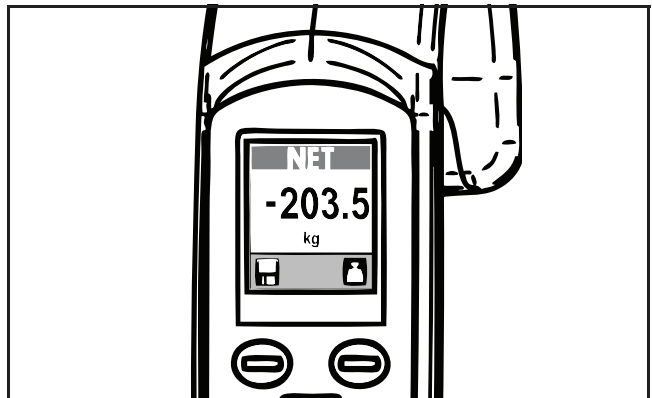

Fig. 60

- 4) Press the save button if the net weight needs to be kept in memory. Horizontal bars will appear above and below the digits on the screen to show that the save function is activated. "Save" will stay active until the save button is pressed again.

CAUTION: If the unit is reset while the patient is still suspended in the sling, the scale will move out of its zero range and display "8888.8" to indicate an error status. Remove the patient from the MAXI MOVE and reset the unit.

Units of Measure

The unit of measure is set in kilograms for Europe and can't be changed. For non-European instruments, the unit of measure can be set in either "kg" or "lb".

- 1) At start-up, press both operating buttons for the scale at the same time (see Fig. 68).

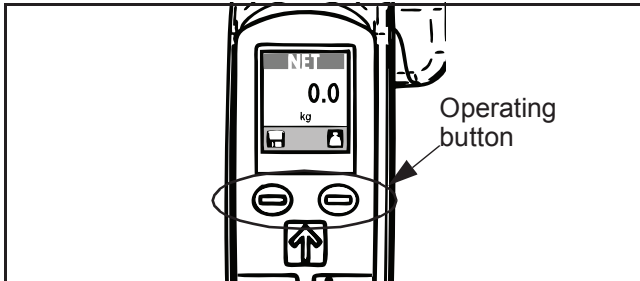

Fig. 61

This will access the Hoist Status screen. Two crossed wrenches will be displayed in the centre of the screen. Up and down arrows will also appear at the top and bottom of the screen (see Fig. 69).

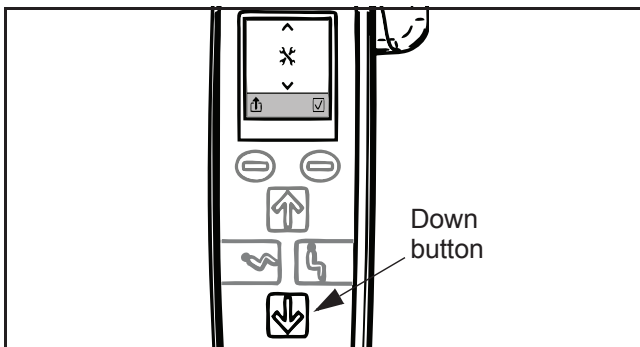

Fig. 62

- 2) Next, press the Down button to access the configuration menu.

The scale icon will replace the crossed wrenches in the centre of the screen (see Fig. 70).

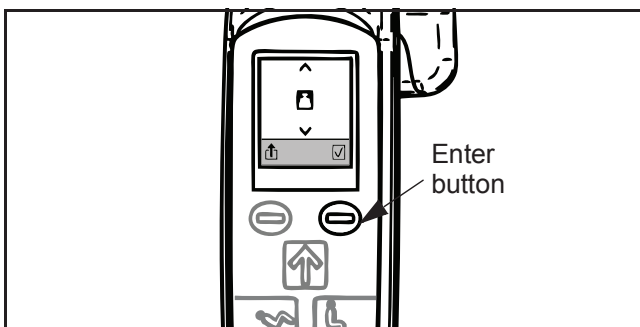

Fig. 63

- 3) Press the Enter button to access the units of measurement option. The units of measurement "kg" or "lb" will replace the scale icon in the middle of the screen (see Fig. 71).

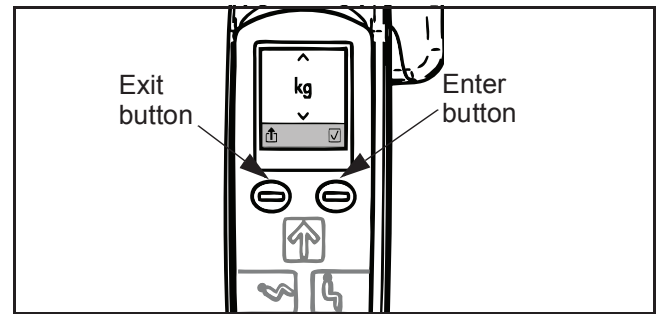

Fig. 64

- 4) Press the Down button to switch between "kg" and "lb".
- 5) To save settings and return to normal mode, press the Enter button. To exit without saving changes, press the Exit button.

Scale - Handset Instructions Mini-Guide

METHOD A

AT START-UP

With sling already on the spreader bar

STEP 1

The unit has already zeroed automatically, and the weight of the sling has been taken into account.

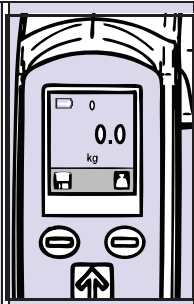

STEP 2

Weigh the patient. The number on the display is the patient's actual weight.

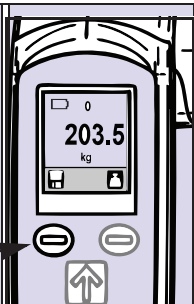

TO SAVE DATA

Press the save button to keep the displayed measurement on screen. Press the save button again to go back to normal use.

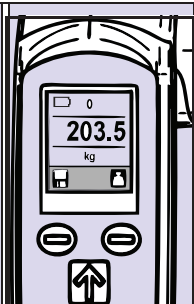

AT START-UP

With sling not yet on the spreader bar

STEP 1

Add the sling to the spreader bar. The display will show the weight of the sling.

Scale button

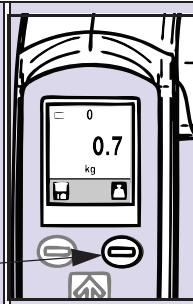

STEP 2

Press the scale button to tare. Now the display will show a zero weight.

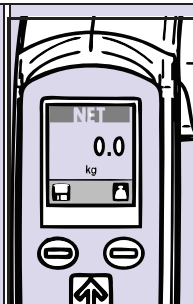

STEP 3

Weigh the patient. The number displayed will be the patient's actual weight.

Save button

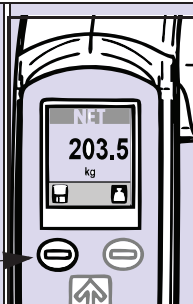

TO SAVE DATA

Press the save button to keep the displayed measurement on screen. Press the save button again to go back to normal use.

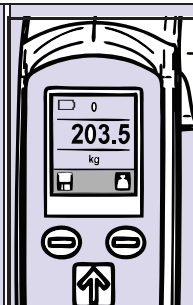

METHOD B

DURING A TRANSFER

With patient already on the lift

STEP 1

Press the scale button to obtain a zero reading on the display.

Scale button

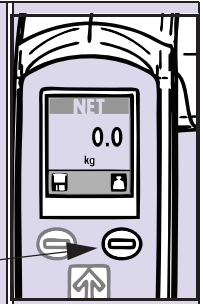

STEP 2

Complete the transfer and remove the patient from the lift. The reading on the display will become a negative number.

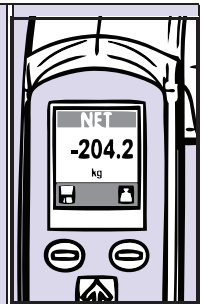

STEP 3

Install the sling back onto the spreader bar. Ignore the minus sign. The reading on the display is the patient's actual weight.



TO SAVE DATA

Press save button to keep weight on screen. Press save button again to go back to normal use.



Scale - Handset Instructions Mini-Guide

CHANGING THE UNITS OF MEASURE

AT START-UP

STEP 1

To display the Hoist Status Screen, press both operating buttons at the same time.

Operating buttons

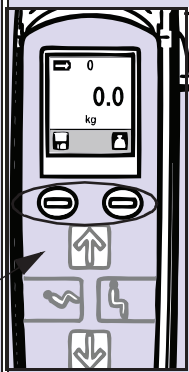

STEP 2

To access the configuration screen, press the down button on the handset. The first screen displayed will be the Weight Unit screen.

Down button

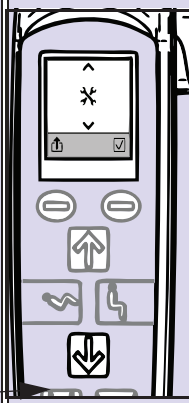

STEP 3

Press the save button to keep the displayed measurement on screen. Press the save button again to go back to normal use.

Enter button

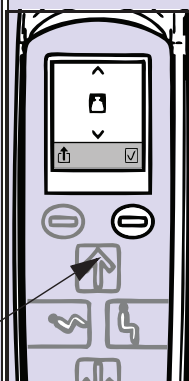

STEP 4

To switch between kg and lb, press the down button.

Down button

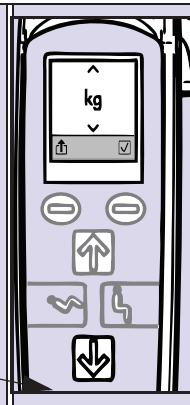

STEP 5

To save settings and return to normal use, press the enter button.

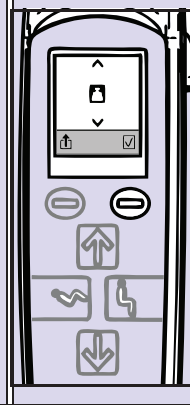

WARNING SCREENS

OVERLOAD WARNING

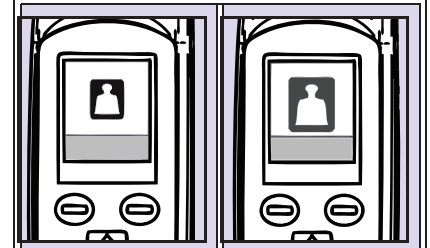

The display will show alternating large and small scale symbols. Lower the patient immediately.

UNDERLOAD WARNING

The display will show an underload limit value. Remove the weight and reset the lift.

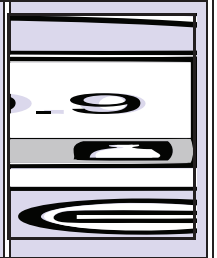

TILT WARNING (FOR EUROPEAN SCALES ONLY)

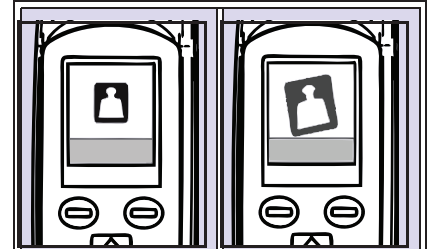

The display will alternate the scale symbol with a larger tilt symbol. Relocate to a level floor and try weighing again.

LOW BATTERY

The top left-hand corner of the display will show a low battery symbol. Recharge batteries as soon as possible.

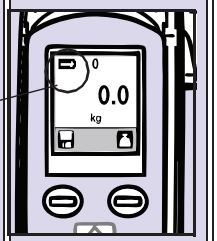

OTHER WARNINGS

The display will show crossed wrenches on the top right corner. Contact an Arjo technician for service.

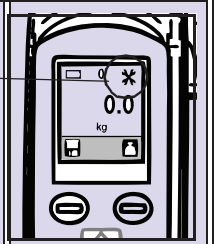

(continued next column)

Battery Charging

The MAXI MOVE has a battery charge indicator feature with the control handset. The battery charge level automatically appears on the LCD soon after the initial start-up, or after returning from sleep mode (see Fig. 72).

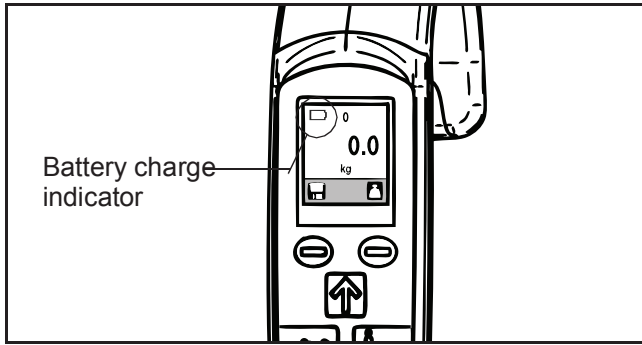

Fig. 65

To prolong the life of the batteries, it is recommended that the battery pack be recharged on a regular basis, before the batteries reach a low state of charge. Care should be taken so that the batteries are not drained unnecessarily.

The battery indicator on the control handset will show if the batteries for the MAXI MOVE are close to being completely empty and it will emit two beep every minute (see Fig. 73). At that point, you should complete your transfer and charge the battery.

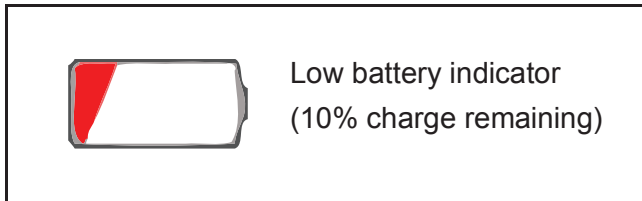

Fig. 66

If the batteries are completely drained, the lift will automatically go into sleep mode. With any attempt to use the lift, the unit will beep 3 times, and the handset will briefly display the low battery icon. The lift will then return to sleep mode and will not be operable unless the batteries are recharged.

Battery Pack

Battery life is variable (2-3 years) and is influenced by proper charging practices and load exertion.

CAUTION: Batteries need to be charged for a minimum of 8 hours prior to the initial use of the lift to ensure the efficiency of the product and extend the battery lifetime .

Removing the Battery Pack

When the battery charge indicator on the control handset displays the low battery icon, complete the lift cycle. Then take the lift to a convenient location and remove the battery pack. The removable battery pack reduces the time your lift is out of service because of discharged batteries. To remove a discharged battery pack, push the red button and pull straight out towards you (see Fig. 74). Replace the pack with a fully charged one from the wall mounted charging unit.

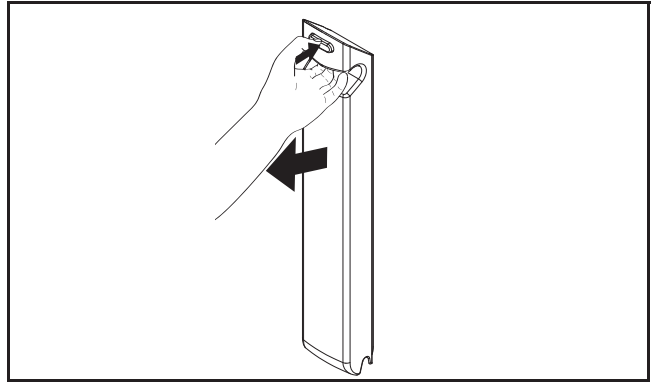

Fig. 67

Charging the Battery

The MAXI MOVE uses sealed lead-acid batteries mounted below the control box. Lead-acid batteries are not subject to a memory effect. Therefore, they need not be completely drained before being recharged. The control box is equipped with an automatic control shut-off after two minutes of inactivity to prevent any battery drainage while the lift is in the stand-by mode. Power to the lift is reactivated by pushing any handset or control panel button.

It is recommended that the battery pack be removed from the lift when it is not used for an extended period of time, and recharged when the battery discharge indicator on the control handset display shows a low battery indicator.

To prolong the life of the batteries, recharge them before they reach a low level of battery charge.

Your lift is equipped with an audible warning device, which will make a noise when the battery discharge indicator on the handset displays a low battery icon.

To ensure that the MAXI MOVE is always ready for use, it is recommended that a fully charged battery pack always be on hand. Do this by having additional battery packs available and keeping one charging while the other is in use.

When a fully charged battery pack is inserted into the lift, the display on the handset will show a green fully charged battery. However, if a partially charged battery is inserted, the handset will reflect the corresponding battery level status.

Only use batteries designed and labelled for use with the device. When not sure, do not use the battery. Make sure the battery belongs to the device by comparing the battery label with the technical specifications in the Instructions for Use. If battery type cannot be confirmed, call qualified personnel.

Recharging the battery:

Refer to the Wall Mounted Battery Charger - Instructions for Use 001-24257-**.

WARNING: Hold the pack firmly to ensure that it does not drop and become damaged or cause personal injury.

WARNING: Do not place or store the battery pack under direct sunlight or near a heat source to avoid risk of fire and/or chemical leak.

WARNING: Do not expose the batteries to flames. They might open, causing a chemical leak.

A good protocol to follow can include having fully charged batteries ready for the start of every work shift.

For recycling and disposal of the battery packs, the rules according to local regulations must be followed. If not, they may explode, leak and cause personal injury. When returning batteries, insulate their terminals with adhesive tape, otherwise, the residual electricity in used batteries may cause fire or explosions. The following diagram shows the symbols for disposal and recycling (see Fig. 75).

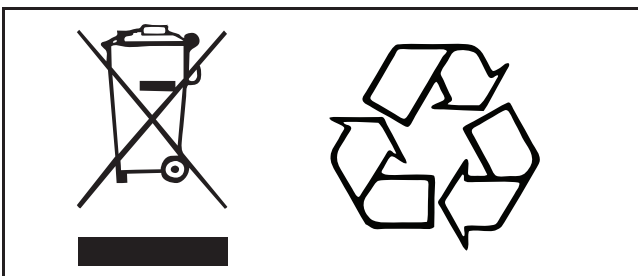

Fig. 68

Battery and Battery Charger Safety Practices

Refer to the Wall Mounted Battery Charger - Instructions for Use 001-24257-**.

Care of your MAXI MOVE

The frequency of the following actions depends on how often the product is used. Unless otherwise stated, follow the cleaning, care and inspection procedures described in this section before each and every use.

Sling Cleaning and Care

The slings should be checked before and after each patient use and if necessary, washed in strict accordance to the instructions on the sling. This is especially important when using the same product for another patient, as it can minimise the risk of cross-infection. Also refer to sling instruction sheet MAX81785M-INT.

Mechanical pressure, such as rolling or pressing, should be avoided during the washing and drying procedure, as this can damage parts that are vital to the safe and comfortable operation of the sling.

The strap stretcher cross straps and suspension straps should be checked and washed if necessary. Washing and drying temperatures must not exceed 80°C (176°F). Wash using normal detergents. Do not iron. Also refer to the Sling Instruction sheet MAX81785M-INT.

It is essential that the slings, sling loops, straps and attachment clips are carefully inspected before each and every use. If the slings, loops or straps are frayed or the clips damaged, the sling must not be used and should be replaced immediately.

Lift Cleaning, Disinfection and Care

NOTE: It is recommended to clean the lifts and their accessories between each patient use.

WARNING: To avoid eye and skin injury never disinfect the lift or accessories in the presence of a patient and always use protective glasses and gloves. If contact occur rinse with plenty of water. If eyes or skin become irritated seek for medical attention. Always read the material safety data sheet related to the disinfectant.

Removing Visible Residues:

- 1) Use a cloth soaked with water.
- 2) Remove visible residues from the ceiling lifts and accessories from top to bottom.

General Cleaning:

- 1) Use a damp cloth with warm water mixed with a mild detergent.
- 2) Scrub the equipment from top to bottom, removing all visible residues.
- 3) Rinse with clean water any remaining residual detergent. Then wipe clean with a dry cloth.

NOTE: Pay special attention to areas pointed below. These are most likely to enclose germs. Use a smaller brush and/or cotton swab to reach them.

Rub the equipment vigorously when using the wipes, to promote an effective cleaning of the lift's surfaces.

CAUTION: Do not drench the product, as this could damage electrical components and cause internal corrosion.

If a hot air dryer is used to dry the lift, the temperature must not exceed 80°C (176 °F).

Do not use methanol-based or any other type of solvents that may damage the finish or plastic parts.

Care of your MAXI MOVE

Maxi Move Special Areas to Clean and Disinfect

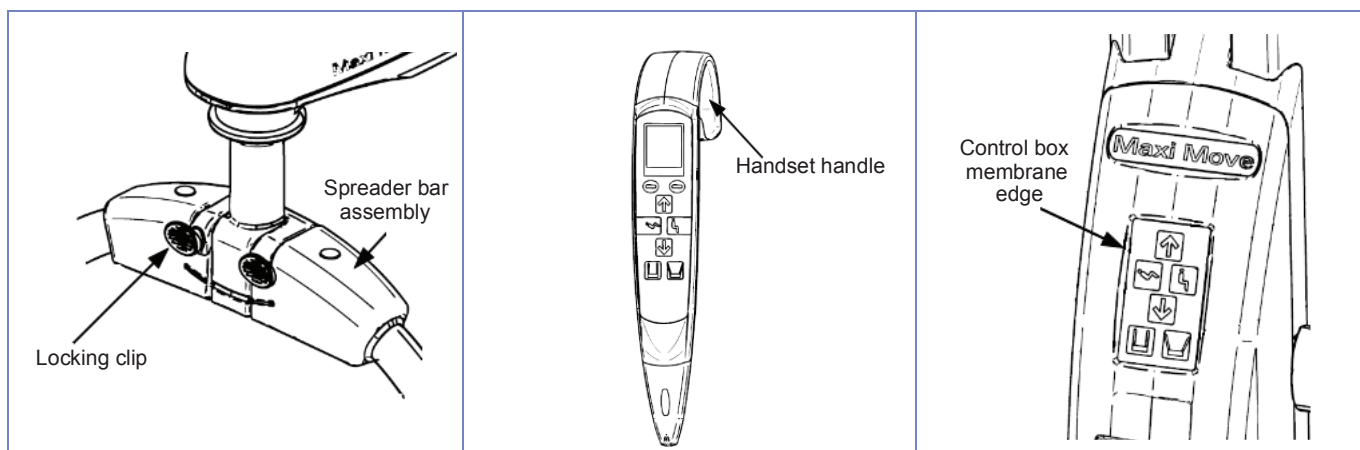

Fig. 69

To disinfect the device, clean the equipment first, then wipe it using a solution containing one of the compatible disinfectants below:

Disinfectant Agents	Maxi Move	Locking Clip	Spreader Bar Assembly	Handset Handle	Control Box Membrane Edge
Quaternary Ammonium ≤ 0.28% (2,800 ppm)	X	X	X	X	X
Isopropyl Alcohol ≤ 70%	X	X	X	X	X
Phenolic ≤ 1.56% (15,600 ppm)	X	X	X	X	X
Peracetic Acid ≤ 0.25% (2,500 ppm)	X	X	X	X	X
Bleach ≤ 1% (10,000 ppm)	X	X	X	X	X
Hydrogen Peroxide ≤ 1.5%	X	X	X	X	X

NOTE: Disinfection of the device may cause discoloration on some of its parts. The handset cable (bleach and/or hydrogen peroxide) and DPS handle (hydrogen peroxide) may become slightly grimy after repeated contact with the mentioned disinfecting agents.

Disinfection methods should comply with the local or national guidelines (Decontamination of Medical Devices), depending on the Healthcare Facility or country of use. If uncertain, consult local Infection Control specialist.

CAUTION: Do not drench the product, as this could damage electrical components and cause internal corrosion. If a hot air dryer is used to dry the lift, the temperature must not exceed 80°C (176 °F). Do not use petroleum-based solvents, as this may damage plastic parts.

Disinfectant wipes, which are supplied impregnated with a 70% v/v solution of Isopropyl Alcohol, can also be used. Rub the equipment vigorously when using the wipes, to promote an effective disinfection of the lift's surfaces. Using 70% v/v Isopropyl Alcohol wipes has been proven to be effective against MRSA and several other micro-organisms under light soiling conditions.

Page intentionally left blank

Mandatory Daily Checks

The following checks should be carried out daily:

- Ensure that the battery pack is always fully charged.
- Ensure that the castors are firmly secured to the chassis.
- Carefully inspect all parts, in particular where there is close contact with the patient's body. Ensure that no cracks or sharp edges have developed which could injure the patient's skin or become unhygienic.
- Check that all external fittings are secure and that all screws and nuts are tight.
- Ensure that all the instruction labels are firmly attached and in a readable condition.

Periodic Testing

Some testing needs to be carried out at weekly intervals. Periodic testing of the various functions is advisable to ensure everything operates properly. If there is anything you are not sure about, or if you notice any changes in the performance of your lift, please contact your local Arjo agent.

Test for full and efficient movement of the lift/lower mechanism: Raise and lower the jib using the control handset. Test the mechanism with the switches on the control panel as well.

Automatic Stop Function: With the jib well above its lowest position and the lift positioned over an empty bed, use the handset control to lower the jib onto the bed. When the jib lowering becomes restricted, the motor will stop. Release the handset lower button after a second or two. Use the control handset to raise the jib. Then repeat this test using the control panel. This is to check for the correct functioning of the automatic stop.

Immediate Stop: To test the immediate stop function, operate the remote control handset to lift or lower the jib. While operating, press the stop button (see Fig. 8). Powered movement should stop immediately.

Press the power button to reset to the normal function (see Fig. 8). Repeat this test using the control panel. Reset to normal function. Repeat this check for the chassis leg opening/closing function, and reset the power button.

Adjustable Width Chassis Function: Use the control handset or the control panel to open and close the chassis legs to check for full and efficient movement.

General Lift Condition: Perform a general visual inspection of all external parts, and test all functions for correct operation, to ensure that no damage has occurred during use.

CAUTION: If in doubt about the correct functioning or lack of performance of the MAXI MOVE, do not use it and contact the Arjo Service Department.

Servicing Advice

Arjo recommends that the MAXI MOVE be maintained at regular intervals. See the MAXI MOVE Preventive Maintenance Schedule (Arjo Literature No. 001.25065).

Under normal use, the following items are subject to wear: slings, batteries, straps and castors. These items must be regularly checked as described previously, and replaced as needed.

WARNING: Never proceed to do maintenance or to service the lift while in use with a patient.

WARNING: UK LIFTS ONLY: Important legislation came into force on 5 December 1998, which has an impact on the schedule of service for your patient lift(s), variable height baths and other raising and lowering equipment. The Lifting Operations and Lifting Equipment Regulations (LOLER) 1998 and The Provision and Use of Work Equipment Regulations (PUWER 98) must be satisfied by the owner. A schedule of thorough examinations every six months has been developed to comply with the law. Details can be obtained from Arjo Service UK.

Parts lists and circuit diagrams are available upon request from Arjo or its approved distributors. If required, spare parts are available from Arjo or its approved distributors.

Special tools are required for the replacement of certain components. The simplest, safest and most effective way to maintain your product is to have it methodically and professionally serviced by an Arjo approved representative using Arjo approved spare parts.

For information on service including Repair and Maintenance manuals, as well as maintenance contracts, please contact your local Arjo distributor.

Troubleshooting

Lift Trouble	Resolution
Handset does not respond	<ul style="list-style-type: none"> • Check the red stop button on the control box. • Check the connector on handset cord. • Check the battery condition (replace with a fully charged battery pack).
RAISE and LOWER buttons on control box do not respond	<ul style="list-style-type: none"> • Check the red button on the control box. • Check the battery condition (replace with a fully charged battery pack).
Powered DPS does not respond	<ul style="list-style-type: none"> • Check the red stop button on control box. • Check if the handset is connected. • Check if the carry bar is correctly installed
The control box emits two audible “beeps” every 30 seconds.	<ul style="list-style-type: none"> • Battery is low. Replace with a freshly charged battery pack.
The control box emits three audible “beeps” and the lift shuts-off.	<ul style="list-style-type: none"> • Battery is low. Replace with a freshly charged battery pack.
The control box emits a 1-second beep with the handset screen color alternating between red and black.	<ul style="list-style-type: none"> • The lift is locked. Push the Down button to lower the jib to unlock.
The control box emits audible beeps in conditions other than those mentioned above.	<ul style="list-style-type: none"> • Call Arjo for service.
Actuator “stalls” during lift	<ul style="list-style-type: none"> • Battery is low. Replace with a freshly charged battery. Do not exceed the lifting capacity.

Charger Trouble

Refer to the Wall Mounted Battery Charger - Instructions for Use 001-24257-**.

Battery Trouble	Resolution
Battery pack is properly seated but no lights are visible.	<ul style="list-style-type: none"> • Call for service (charger may be faulty).
Yellow indicator light does not go off after several hours of charging time.	<ul style="list-style-type: none"> • Battery pack needs replacing. Call ArjoHuntleigh for replacement.
Battery pack indicates it is fully charged when in the charger, but when placed in the lift, will only do a few lifts.	<ul style="list-style-type: none"> • Battery pack needs replacing. Call ArjoHuntleigh for replacement.

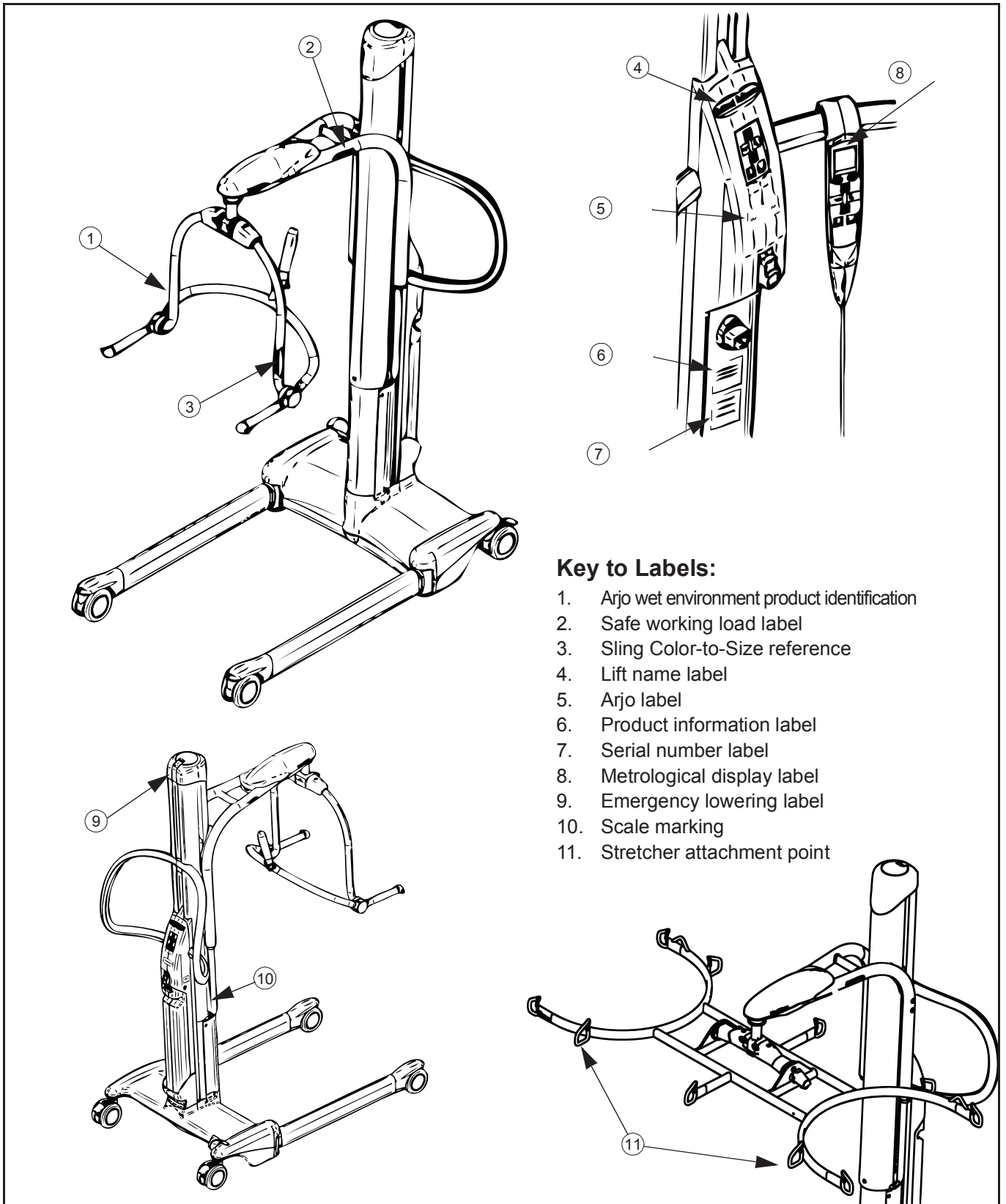

Fig. 70

Technical Specifications

PRODUCT INFORMATION		MAXI MOVE
Total weight (standard jib, without accessories)	64.5 kg (142 lb)	
Lifting capacity (SWL)	Regular jib: 227 kg (500 lb) Extended jib: 130 kg (287 lb)	
Battery pack weight	5.0 kg (11 lb)	
Turning Diameter	1222 mm (48 in)	
Minimum door requirement	717 mm (28.25 in) for Standard Base (KMCS _{**}) & Low Height Base (KMCL _{**}) 770 mm (30 3/8 in) for Extra Low Height Base (KMCE _{**})	
Operating forces of controls	2.5- 3N	
ELECTRICAL		
Degree of protection	IPx7 - Hand control IP24 - MAXI MOVE	
Internally powered	24 Vdc	
Battery Type	Rechargeable (Sealed Lead Acid)	
Battery Capacity	24 Vdc, 4.0 Ah to 5.5 Ah	
Battery charger input (part #NDA8200)	100 to 240 Vac / 50 to 60 Hz	
Up and down current limiting	12 ± 1 Amp.	
Duty cycle	15% - max. 2 min. continuous use	
Sound power level up	61.9 dBA	
Sound power level down	61.7 dBA	
Medical equipment	Type BF protection against electrical shock in accordance with IEC 60601-1	
<p>This Arjo product meets the requirements of IEC 60601-1-2 for Electromagnetic Compatibility.</p> <p>The MAXI MOVE is compliant to IEC 60601-1 series including applicable collateral standards and national deviations. The MAXI MOVE is compliant to ISO 10535 standard (except when being used in conjunction with a stretcher; see "Using your MAXI MOVE" section).</p>		
<p>WARNING: Portable RF communications equipment (including peripherals such as antenna cables and external antennas) should be used no closer than 30 cm to any part of the Maxi Move, including cables specified by the manufacturer. Otherwise, performance degradation of this equipment could result.</p> <p>See "Electromagnetic Compatibility" section for more details.</p>		
DIGITAL SCALE SPECIFICATIONS		
Weight range	227 kg (500 lb)	
Display resolution and type	0.1 kg (0.2 lb), liquid crystal display	
Accuracy (in service)	Class III 2-50 kg ±50 g / 4-110 lb ±0.1 lb 50-200 kg ±100 g / 100-440 lb ±0.2 lb 200-227 kg ±150 g / 440-500 lb ±0.3 lb	
OPERATION AND STORAGE CONDITIONS		
Ambient temperature range	Operation: 5° to 40°C (+41° to +104°F) Storage: - 25° to 70°C (-13° to 158°F)	
Relative humidity range	Operation: 15 to 93% (non-condensing) Storage: Up to 93% (non-condensing)	
Atmospheric pressure range	Operation: 795 hPa to 1060 hPa (2000 m max) Storage: 500 hPa to 1060 hPa	
<p>WARNING: The equipment is not suitable in the presence of flammable anaesthetic mixture with air or oxygen, or with nitrous oxide. Using the MAXI MOVE in this environment might lead to an explosion. The lift might create some spark internally and ignite the gas.</p>		
SAFE DISPOSAL AT END OF LIFE		
Battery	Seal lead-acid, rechargeable, recyclable. All batteries in the product must be recycled separately. Batteries are to be disposed in accordance with national or local regulations.	
Package	Corrugated cardboard: recyclable Expanded polystyrene (ESP): recyclable	

Technical Specifications

The Lift and its accessories	Separate and recycled. Components that are primarily be made up of different kinds of metal (containing more than 90% metal by weight) for example spreader bars, rails, upright supports, etc., should be recycled as metals.
Electrical and Electronic Components	Lift systems having electrical and electronic components or an electrical cord should be disassembled and recycled per Waste of Electrical and Electronic Equipment (WEEE) or in accordance with local or national regulation.
Slings	Slings including stiffeners/ stabilizers, padding material, any other textiles or polymers or plastic materials etc. should be sorted as combustible waste.

Lift Dimensions

- 1) DIMENSIONS TAKEN WITH HOIST UNLOADED
- 2) DIMENSIONS TOLERANCES: ± 10 MM (3/8")

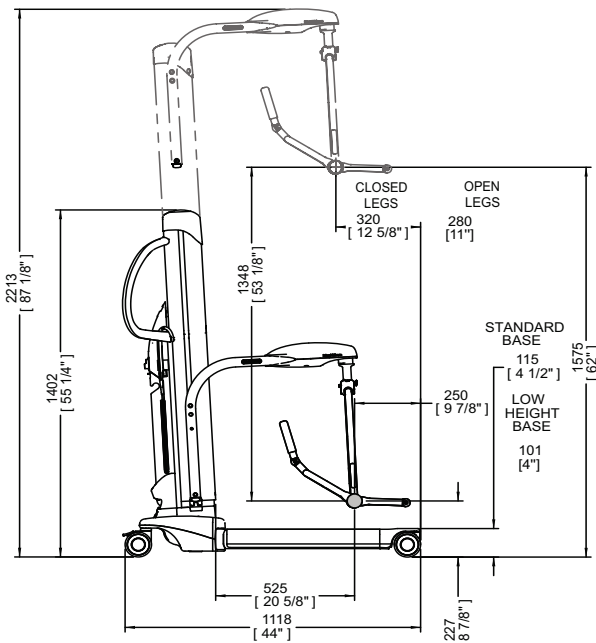

WITH DPS SPREADER BAR STANDARD BASE & LOW HEIGHT BASE (REGULAR JIB)

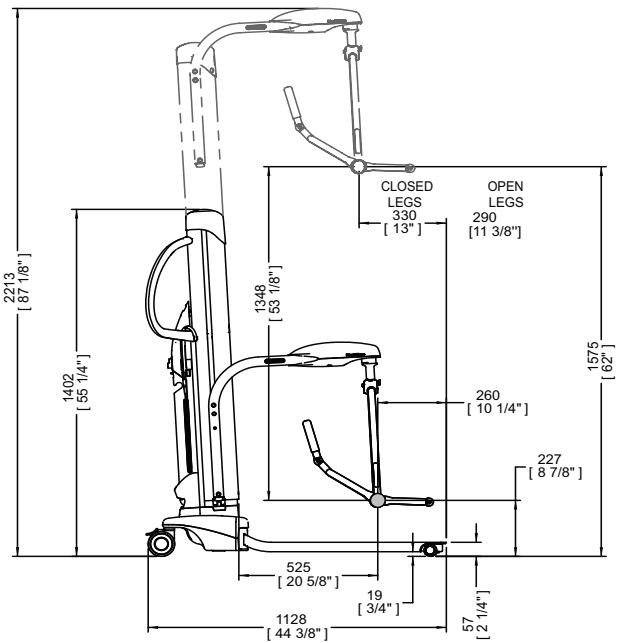

WITH DPS SPREADER BAR EXTRA LOW HEIGHT BASE (REGULAR JIB)

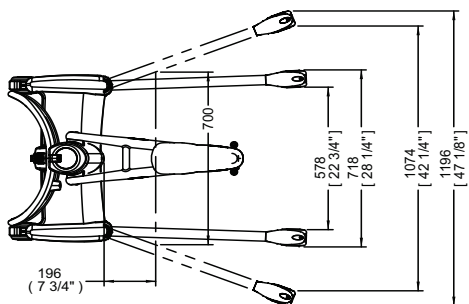

BASE DIMENSIONS
(STANDARD BASE & LOW HEIGHT BASE)

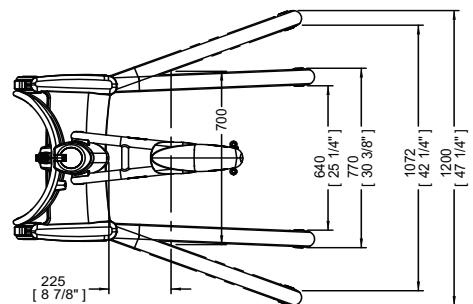

BASE DIMENSIONS
(EXTRA LOW HEIGHT BASE)

Technical Specifications

Lift Dimensions

- 1) DIMENSIONS TAKEN WITH HOIST UNLOADED
- 2) DIMENSIONS TOLERANCES: ± 10 MM (3/8")

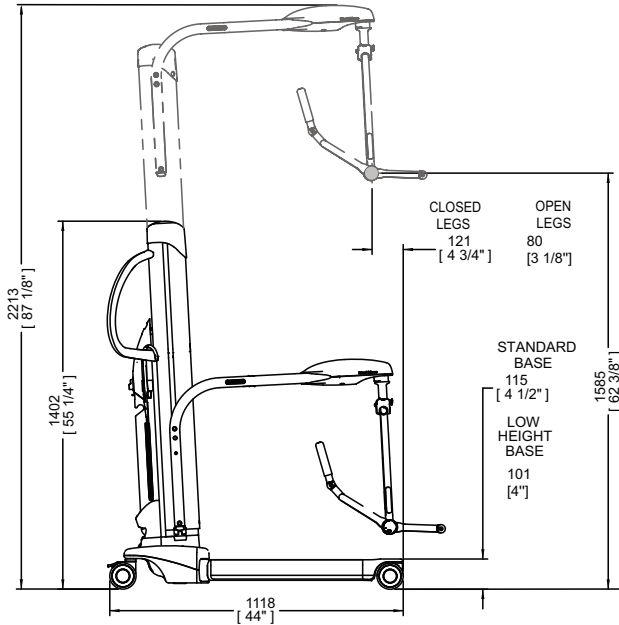

WITH DPS SPREADER BAR STANDARD BASE & LOW HEIGHT BASE (EXTENDED JIB)

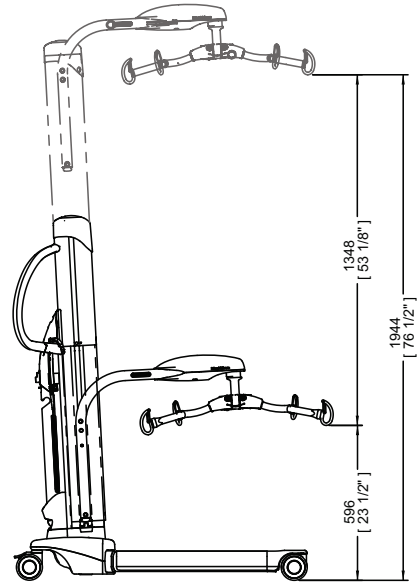

WITH 4-POINT LOOP SPREADER BAR

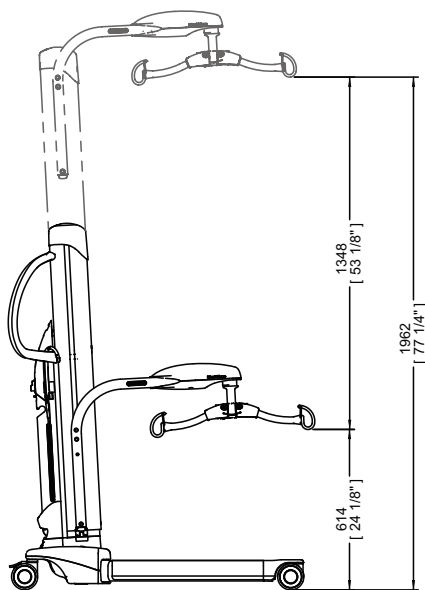

WITH 2-POINT LOOP SPREADER BAR

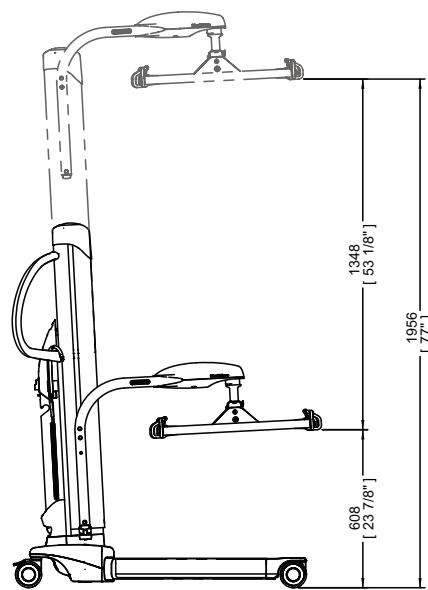

WITH STRETCHER SPREADER BAR

Fig. 71

Appendix - Scale Gravity Code Configurations

Whenever the MAXI MOVE floor lifts with scale are sold in Europe, the conformity of the scale with the requirements of the Council Directive 90/384/EEC as amended, are established by tests referred to in EN45501-8.2. This verification of conformity is valid only for the location of use, since the gravity has been adjusted prior to delivery of the unit and sealed by the calibration and gravity counter on the scale marking.

A two-digit gravity code is assigned to the scale according to the geographical location where it will be used. This code can be viewed by following the step outlined below.

NOTE: When the preset code is 99, it means that the scale has been adjusted to the exact latitude and altitude corresponding to the specific geographical location where it will be used.

NOTE: Gravity codes cannot be changed using the operating menu. Contact your Arjo representative for more information.

Viewing the Gravity Code Configuration

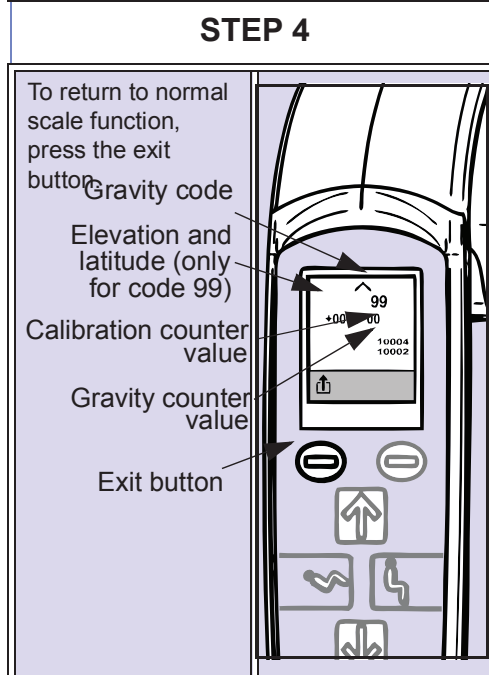
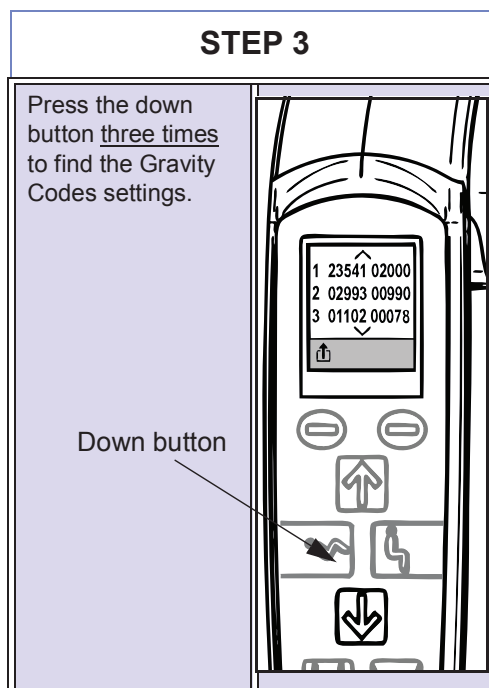
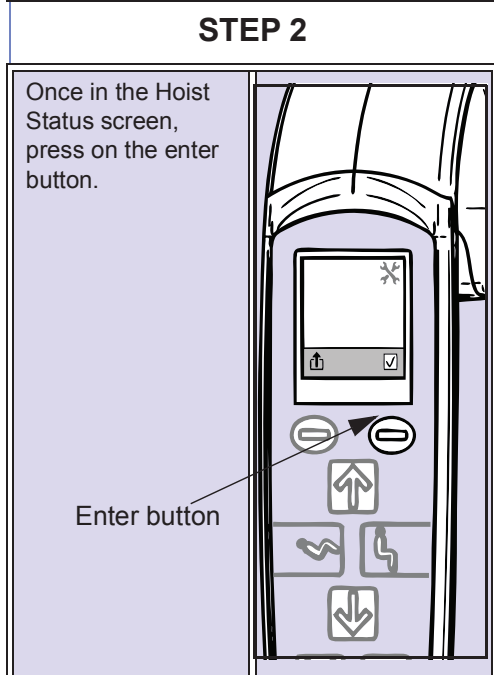
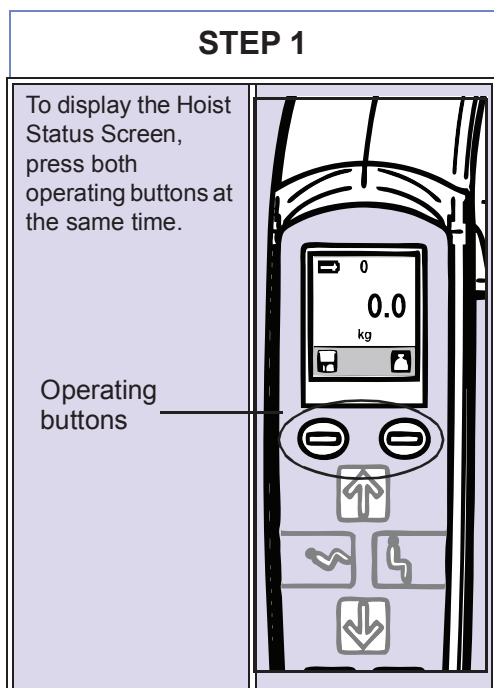

Electromagnetic Compatibility

Electromagnetic Compliance

The MAXI MOVE has been tested for compliance with current regulatory standards regarding its capacity to block EMI (electromagnetic interference) from external sources.

Nonetheless, some procedures can help reduce electromagnetic interferences:

- Ensure that other devices in patient-monitoring and/or life-support areas comply to accepted emissions standards.
- Maximise the distance between electro-medical devices. High-powered devices may produce EMI that can affect the lift.

For more information on how to manage the unit's RF electromagnetic environment, please consult the *AMI TIR 18-1997 - Guidance on Electromagnetic Compatibility of Medical Devices for Clinical/Biomedical Engineers*.

WARNING: Use of accessories, cables and spare parts other than those specified or provided by Arjo could result in increased electromagnetic emissions or decreased electromagnetic immunity of this equipment and result in improper operation.

WARNING: Use of this equipment adjacent to or stacked with other equipment should be avoided because it could result in improper operation. If such use is necessary, this equipment and the other equipment should be observed to verify that they are operating normally.

WARNING: The equipment may cause radio interference or may disrupt the operation of nearby equipment. It may be necessary to take action, such as reorienting, relocating the equipment or shielding the location.

Electromagnetic Emissions

Guidance and Manufacturer's Declaration - Electromagnetic Emissions - For all Equipment and Systems

The MAXI MOVE is intended for use in the electromagnetic environment specified below. The customer or the user of the MAXI MOVE should assure that it is used in such an environment.

Emissions test	Compliance	Electromagnetic environment - guidance
RF emissions CISPR 11	Group 1	The MAXI MOVE uses RF energy only for its internal function. Therefore, its RF emissions are very low and are not likely to cause any interference in nearby electronic equipment.
RF emissions CISPR 11	Class B	The MAXI MOVE is suitable for use in all establishments, including domestic establishments and those directly connected to the public low-voltage power supply network that supplies buildings used for domestic purposes.

Electromagnetic Compatibility

Electromagnetic Immunity

Guidance and Manufacturer's Declaration - Electromagnetic Immunity - For all Equipment and Systems			
The MAXI MOVE is intended for use in electromagnetic environment specified below. The customer or the user of the MAXI MOVE should assure that it is used in such an environment.			
Immunity test	IEC 60601 test level	Compliance level	Electromagnetic environment - guidance
Electrostatic discharge (ESD) IEC 61000-4-2	±8 kV contact ±15 kV air	±8 kV contact ±15 kV air	Floors should be wood, concrete or ceramic tile. If floors are covered with synthetic material, the relative humidity should be at least 30%.
Conducted RF IEC 61000-4-6	3 V outside ISM bands between 0.15-80 MHz 6 V inside ISM and amateur radio bands between 0.15-80 MHz	3 V outside ISM bands between 0.15-80 MHz 6 V inside ISM and amateur radio bands between 0.15-80 MHz	N/A
Radiated RF IEC 61000-4-3	10 V/m 80 MHz to 2.7 GHz	10 V/m 80 MHz to 2.7 GHz	N/A
Electrical fast transient/burst IEC 61000-4-4	±1 kV for input/output ports 100 kHz repetition frequency	±1 kV for input/output ports 100 kHz repetition frequency	Mains power supply should be that of a typical commercial or hospital environment.
Power frequency (50/60 Hz) magnetic field IEC 61000-4-8	30 A/m 50/60 Hz	30 A/m 50/60 Hz	Power frequency magnetic fields should be at levels characteristic of a typical location in a typical commercial or hospital environment.
Proximity fields from RF wireless communications equipment IEC 61000-4-3 (continued)	380 - 390 MHz 27 V/m; PM 50%; 18 Hz 430 - 470 MHz 28 V/m; (FM ±5 kHz, 1 kHz sine) PM; 18 Hz 704 - 787 MHz 9 V/m; PM 50%; 217 Hz	380 - 390 MHz 27 V/m; PM 50%; 18 Hz 430 - 470 MHz 28 V/m; (FM ±5 kHz, 1 kHz sine) PM; 18 Hz 704 - 787 MHz 9 V/m; PM 50%; 217 Hz	N/A

Electromagnetic Compatibility

Immunity test	IEC 60601 test level	Compliance level	Electromagnetic environment - guidance
(continued) Proximity fields from RF wireless communications equipment IEC 61000-4-3	800 - 960 MHz 28 V/m; PM 50%; 18 Hz	800 - 960 MHz 28 V/m; PM 50%; 18 Hz	N/A
	1700 - 1990 MHz 28 V/m; PM 50%; 217 Hz	1700 - 1990 MHz 28 V/m; PM 50%; 217 Hz	
	2400 - 2570 MHz 28 V/m; PM 50%; 217 Hz	2400 - 2570 MHz 28 V/m; PM 50%; 217 Hz	
	5100 - 5800 MHz 9 V/m; PM 50%; 217 Hz	5100 - 5800 MHz 9 V/m; PM 50%; 217 Hz	

Page intentionally left blank

Page intentionally left blank

AUSTRALIA

Arjo Australia
 Building B, Level 3
 11 Talavera Road
 Macquarie Park, NSW, 2113, Australia
 Phone: 1800 072 040

BELGIQUE / BELGIË

Arjo Belgium nv
 Evenbroekveld 16
 9420 Erpe-Mere
 Belgium
 T: +32 (0) 53 60 73 80
 F: +32 (0) 53 60 73 81
 E-mail: info.belgium@arjo.com

BRASIL

Arjo Brasil Equipamentos Médicos Ltda
 Rua Marina Ciufuli Zanfelice, 329 PB02 Galpão
 - Lapa
 São Paulo – SP – Brasil
 CEP: 05040-000
 Phone: 55-11-3588-5088
 E-mail: vendas.latam@arjo.com
 E-mail: servicios.latam@arjo.com

CANADA

Arjo Canada Inc.
 90 Matheson Boulevard West
 Suite 300
 CA-MISSISSAUGA, ON, L5R 3R3
 Tel/Tél: +1 905 238 7880
 Free: +1 800 665 4831 Institutional
 Free: +1 800 868 0441 Home Care
 Fax: +1 905 238 7881
 E-mail: info.canada@arjo.com

ČESKÁ REPUBLIKA

Arjo Czech Republic s.r.o.
 Na Strži 1702/65
 140 00 Praha
 Czech Republic
 Phone No: +420225092307
 e-mail: info.cz@arjo.com

DANMARK

Arjo A/S
 Vassingerødvej 52
 DK-3540 LYNGE
 Tel: +45 49 13 84 86
 Fax: +45 49 13 84 87
 E-mail:
 dk_kundeservice@arjo.com

DEUTSCHLAND

Arjo GmbH
 Peter-Sander-Strasse 10
 DE-55252 MAINZ-KASTEL
 Tel: +49 (0) 6134 186 0
 Fax: +49 (0) 6134 186 160
 E-mail: info-de@arjo.com

ESPAÑA

Arjo Ibérica S.L.
 Parque Empresarial Rivas Futura, C/Marie Curie 5
 Edificio Alfa Planta 6 oficina 6.1-.62
 ES-28521 Rivas Vacia, MADRID
 Tel: +34 93 583 11 20
 Fax: +34 93 583 11 22
 E-mail: info.es@arjo.com

FRANCE

Arjo SAS
 2 Avenue Alcide de Gasperi
 CS 70133
 FR-59436 RONCQ CEDEX
 Tél: +33 (0) 3 20 28 13 13
 Fax: +33 (0) 3 20 28 13 14
 E-mail: info.france@arjo.com

HONG KONG

Arjo Hong Kong Limited
 Room 411-414, 4/F,
 Manhattan Centre,
 8 Kwai Cheong Road,
 Kwai Chung, N.T.,
 HONG KONG
 Tel: +852 2960 7600
 Fax: +852 2960 1711

ITALIA

Arjo Italia S.p.A.
 Via Giacomo Peroni 400-402
 IT-00131 ROMA
 Tel: +39 (0) 6 87426211
 Fax: +39 (0) 6 87426222
 E-mail: Italy.promo@arjo.com

MIDDLE EAST

Arjo Middle East FZ-LLC
 Office 908, 9th Floor,
 HQ Building, North Tower,
 Dubai Science Park,
 Al Barsha South
 P.O Box 11488, Dubai,
 United Arab Emirates
 Direct +971 487 48053
 Fax +971 487 48072
 Email: Info.ME@arjo.com

NEDERLAND

Arjo BV
 Biezenwei 21
 4004 MB TIEL
 Postbus 6116
 4000 HC TIEL
 Tel: +31 (0) 344 64 08 00
 Fax: +31 (0) 344 64 08 85
 E-mail: info.nl@arjo.com

NEW ZEALAND

Arjo Ltd
 34 Vestey Drive
 Mount Wellington
 NZ-AUCKLAND 1060
 Tel: +64 (0) 9 573 5344
 Free Call: 0800 000 151
 Fax: +64 (0) 9 573 5384
 E-mail: nz.info@Arjo.com

NORGE

Arjo Norway AS
 Olaf Helsets vei 5
 N-0694 OSLO
 Tel: +47 22 08 00 50
 Faks: +47 22 08 00 51
 E-mail: no.kundeservice@arjo.com

ÖSTERREICH

Arjo GmbH
 Lemböckgasse 49 / Stiege A / 4.OG
 A-1230 Wien
 Tel: +43 1 8 66 56
 Fax: +43 1 866 56 7000

POLSKA

Arjo Polska Sp. z o.o.
 ul. Ks Piotra Wawrzyniaka 2
 PL-62-052 KOMORNIKI (Poznań)
 Tel: +48 61 662 15 50
 Fax: +48 61 662 15 90
 E-mail: arjo@arjo.com

PORTUGAL

Arjo em Portugal
 MAQUET Portugal, Lda.
 (Distribuidor Exclusivo)
 Rua Poeta Bocage n.º 2 - 2G
 PT-1600-233 Lisboa
 Tel: +351 214 189 815
 Fax: +351 214 177 413
 E-mail: Portugal@arjo.com

SUISSE / SCHWEIZ

Arjo AG
 Fabrikstrasse 8
 Postfach
 CH-4614 HÄGENDORF
 Tél/Tel: +41 (0) 61 337 97 77
 Fax: +41 (0) 61 311 97 42

SUOMI

Arjo Scandinavia AB
 Riihitontuntie 7 C
 02200 Espoo
 Finland
 Puh: +358 9 6824 1260
 E-mail:
 Asiakaspalvelu.finland@arjo.com

SVERIGE

Arjo International HQ
 Hans Michelsensgatan 10
 SE-211 20 MALMÖ
 Tel: +46 (0) 10 494 7760
 Fax: +46 (0) 10 494 7761
 E-mail: kundservice@arjo.com

UNITED KINGDOM

Arjo UK and Ireland
 Houghton Hall Park
 Houghton Regis
 UK-DUNSTABLE LU5 5XF
 Tel: +44 (0) 1582 745 700
 Fax: +44 (0) 1582 745 745
 E-mail: sales.admin@arjo.com

USA

Arjo Inc.
 2349 W Lake Street Suite 250
 US-Addison, IL 60101
 Tel: +1 630 307 2756
 Free: +1 800 323 1245 Institutional
 Free: +1 800 868 0441 Home Care
 Fax: +1 630 307 6195
 E-mail: us.info@arjo.com

JAPAN

Arjo Japan K.K.
 東京都港区虎ノ門三丁目7番8号 ランディック第
 2虎ノ門ビル9階
 電話 : +81 (0)3-6435-6401

Address page - REV 25: 01/2020

At Arjo, we are committed to improving the everyday lives of people affected by reduced mobility and age-related health challenges. With products and solutions that ensure ergonomic patient handling, personal hygiene, disinfection, diagnostics, and the effective prevention of pressure ulcers and venous thromboembolism, we help professionals across care environments to continually raise the standard of safe and dignified care. Everything we do, we do with people in mind.



ArjoHuntleigh AB
Hans Michelsensgatan 10
211 20 Malmö, Sweden
www.arjo.com

arjo



CE
2797