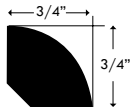
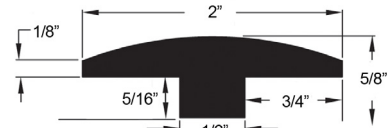
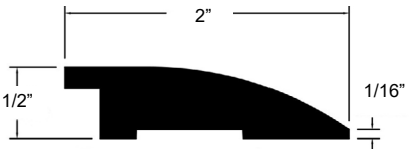
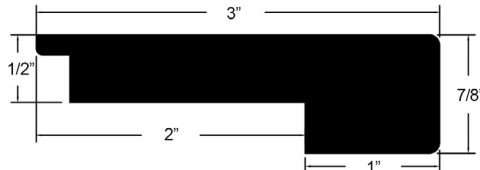
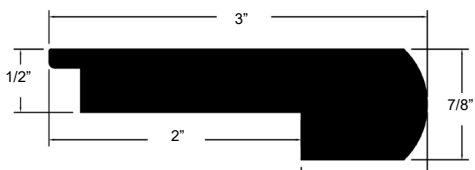

Product Features:

Size:	1/2" x 7-1/2" x Random Length (20" - 75")	
Wood Grade:	Rustic	
Wear Layer Thickness:	2 mm	
Texture/Edge:	Handscraped, Wire-brushed or Smooth finish (style varies by color), Micro-beveled edges	
Treatment:	Colors marked with an asterisk (*) are smoked. All others are natural/not smoked or carbonized.	
Coating/Gloss Level:	UV urethane w/ Aluminum Oxide, Ultra-matte	
Species Available/ Janka Hardness:	European Oak - 1360 Hickory - 1820	Walnut - 1010
Colors:	European Oak Andon (REW1275P2EOAD) European Oak Avene (REW1275P2EOAV) European Oak Colette (REW1275P2EOCL) European Oak Gardanne (REW1275P2EOGD)* European Oak Revel (REW1275P2EORV)* European Oak Leran (REW1275P2EOLR)	European Oak Tallard (REW1275P2EOTL)* European Oak Menton (REW127P2EOMN)* European Oak Vence (REW127P2EOVC)* Hickory Pelcourt (REW1275P2HPC) Walnut Arzens (REW1275P2WAZ) Walnut Palmiers (REW1275P2WPM)

Moldings:	 <p>Quarter Round</p>	 <p>T-Mold</p>	 <p>Reducer</p>
	 <p>Square Nose</p>	 <p>Round Nose</p>	

Technical Specifications:

Packaging:	31.09 SF/CT 40 CT/Pallet
Warranty:	Lifetime Structural Warranty 25 Year Finish Residential Warranty 3 Year Finish Commercial Warranty
Installation:	Glue down, nail + glue, or float. Approved for use over radiant heat systems - review Installation Instructions thoroughly for system requirements before finalizing flooring selection.
Maintenance:	Bona Hardwood Floor Cleaners, please refer to Reward Care & Maintenance Guide for complete instructions.
Compliance:	All Reward Hardwood products are manufactured in compliance with the Food, Conservation, and Energy Act of 2008 (Lacey Act amendment), and are in full compliance with California's Airborne Toxic Control Measure (CARB).  FloorScore® Certified. FloorScore® is a certification program established by the Resilient Floor Covering Institute (RFCI) for hard surface flooring and flooring adhesive products that meet strict indoor air quality (IAQ) requirements. Products bearing the FloorScore label meet the indoor air quality emissions criteria of LEED, CHPS, the Green Guide for Health Care, and are recognized by a long list of healthy building programs. 