

The Original  
**GREEN PAN™**

GreenPan Premium

# APARATE ELECTRICE PENTRU BUCATARIE



The Original  
**GREEN PAN™**

# **O BUCATARIE SANATOASA**

**GreenPan** a revoluționat fiecare  
bucătărie din 2007 – fara **PFAS**

**PFAS-** sunt substante chimice  
utilizate pentru a face produsele  
rezistente la apa, ulei si  
murdarie.





## VASE DE GATIT FARA PFAS – vase de gatit sanatoase

GreenPan a introdus pentru prima oara vase de gatit din ceramica antiaderente fara PFAS, inca din 2007.

GreenPan are o noua misiune: realizarea vaselor de gatit fara PFAS si astfel aduce o revolutie in lumea aparatelor electrice de bucatarie.



## **THERMOLON™ VOLT**

**Primul strat antiaderent ceramic  
conceput special pentru  
aparatele de bucatarie**

**Thermolon™ Volt** Special conceput pentru a rezista la solicitarea aparatelor moderne, această ceramică antiaderentă, cu infuzie de diamant, nu se descompune așa cum fac acoperirile tradiționale. Este foarte dur, se curăță ușor iar orice masă este mai sănătoasă.



## THERMOLON™ VOLT

**SANATOS** Fara PFAS

**SIGUR**

Fara fum, chiar si atunci cand este supraincalzit.

**RAPID**

Transferul de căldură de 10 ori mai rapid decât cel tradițional anti aderent.

**DURABIL** Conceput cu particule de diamant, este sigur pentru ustensile metalice.

**DURATA DE VIATA**

Rezistența la abraziune de 10 ori mai mare.

**SIGUR IN MASINA DE SPALAT VASE**

Nu se deterioareaza din cauza detergentilor.

**PRIETENOSCU MEDIUL**

Cu 60% mai puține emisii de CO2.



The Original  
**GREEN PAN™**

**APARATE ELECTRICE**  
**PENTRU BUCATARIE**

# GreenPan



**OMNI COOKER**



**SLOW COOKER**



**GRILL**



**APARAT PENTRU VAFE**

# The GreenPan



## THERMOLON VOLT

- Gătit sănătos cu rezultate delicioase.
- Cea mai bună suprafață ceramică antiaderentă.
- Ușor, durabil și sănătos.

## USOR DE UTILIZAT

- Programe prestabilite.
- Versatilitate și funcții multiple.
- De la mese mici la mese mari de gătit pentru familie.

## DESIGN INTELIGENT

- Conceput să arate bine pe blatul tău.
- Alegeți culoarea preferată, potrivită cu interiorul bucătăriei sau a vaselor de gătit.



The Original  
**GREEN PAN™**

# OMNI COOKER

Un aparat de bucătărie multifuncțional și ușor de utilizat: se pot prepara sosuri, se poate prăji sau fierbe, se gătește la abur. Posibilitățile sunt nesfârșite!



# OMNI COOKER



## CONCEPUT PENTRU PREPARARI MICI ȘI MARI

Capacitate de 5,6 litri

## MULTĂ VERSATILITATE LA GĂTIT

Ca un arzator  
suplimentar, dar cu 10  
programe prestabilite!

## FĂRĂ ÎNCĂLZIRE PUTERNICĂ

POATE FI UTILIZAT IN  
MASINA DE SPALAT  
VASE





**PENTRU TOTI CEI CARE GATESC  
PENTRU TOATA FAMILIA**



## 10 PROGRAME PRESETATE

1. Prajire si calire
2. Prajita rapida prin agitare
3. Sos
4. Fierbere lenta
5. Gatire cu abur
6. Gatire orez alb
7. Gatire orez brun
8. Cereale
9. Supa
10. Gatire la cald

# OMNI COOKER



Capac din sticla securizata

Mânere cu insertie din oțel inoxidabil

Display LCD cu iluminare verde

Servire si gatire direct de pe blatul de bucatarie



Volum mare de gatire 5,6 litri si suprafata prajire de 30 cm

Suport pentru aburi inclus

Butoane integrate cu o singură atingere, cu presetare ușoară.

# OMNI COOKER



## ALUMINIU TURNAT

Inserție rezistentă din aluminiu turnat sub presiune pentru un transfer superior de căldură

## OȚEL INOXIDABIL

Capacul izolator din oțel inoxidabil va reflecta și menține căldura. Rămâne rece.

## Optimizarea retenției de căldură.

Caldura care este transferata pe exteriorul corpului de aluminiu este reflectata.



## CAPACITATE

Gradare în corpul interior de aluminiu

## THERMOLON VOIT

Tava interioară este acoperită cu strat ceramic, complet fără PFAS.

**Element de încălzire turnat** – preîncălzire super rapidă și distribuție uniformă a căldurii

**Baza cu picioare de silicon** care vă va asigura aparatul de gătit pe orice blat.

Tava interioară și capacul de sticlă se pot spala în mașina de spălat vase



# OMNI COOKER

---



# OMNI COOKER



**INTERVAL DE TEMPERATURĂ  
70-230°C**

**TIMP GATIRE 8 ORE**

**VOLTAJ: 220 – 240 V**

**WATT: 2200 W**

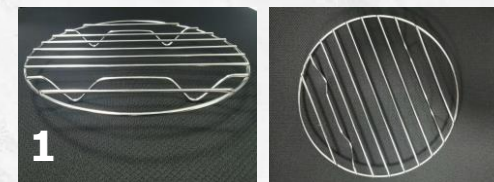

1. Suport pentru abur inclus.





# OMNI COOKER



SCANEAZA QR CODE SI MERGI  
[WWW.GREENPAN.COM](http://WWW.GREENPAN.COM) PENTRU:

- Retete
- Filmari video
- Tutotiale



The Original  
**GREEN PAN™**

# **SLOW COOKER**

## **INSTRUMENTUL PERFECT PENTRU O GĂTIRE GUSTOASA ȘI LENTĂ**

Mâncarea are un gust mai bun dacă  
îți faci timp. Prea ocupat pentru a  
petrece ore întregi în bucătărie? Slow  
Cooker face treaba pentru tine. Mai  
întâi rumeniți sau prăjiți mâncarea  
direct în oală, apoi reduceți  
temperatura și fierbeți-o pentru a  
maximiza aroma.



# **SLOW COOKER**

---



**CONCEPUT PENTRU  
PREPARARI MICI ȘI  
MARI**

Capacitate de 6 litri

**PROGRAME PRESETATE**

**POATE FI UTILIZAT IN  
MASINA DE SPALAT  
VASE**



# SLOW COOKER



## 10 PROGRAME PRESETATE

1. Prajire si calire
2. Prajita rapida prin agitare
3. Sos
4. Fierbere lenta
5. Gatire cu abur
6. Gatire orez alb
7. Gatire orez brun
8. Cereale
9. Supa
10. Gatire la cald

# SLOW COOKER

Capac din sticla securizata

Mânere cu inserție din oțel inoxidabil

Display LCD cu iluminare verde

Tava interioara detasabila.

Sigur in masina de spalat vase.

Tava interioara acoperita cu ceramica anti aderenta fara PFAS

Butoane integrate cu o singură atingere, cu presetare ușoară.



# SLOW COOKER



## ALUMINIU TURNAT

Inserție rezistentă din aluminiu turnat sub presiune pentru un transfer superior de căldură

Ceramica anti aderenta



## THERMO LON VOIT

Tava interioară este acoperită cu strat ceramic, complet fără PFAS.

350W pentru gatire lenta 1000W pentru prajire / gatire normala

Baza cu picioare de silicon care vă va asigura aparatul de gătit pe orice blat.



# SLOW COOKER

---



# **SLOW COOKER**



**TEMPERATURA 74 - 205°C**

**TIMP GATIRE 24 ORE**

**VOLTAJ: 220-240 V**

**WATT: 1350 W**





The Original  
**GREEN PAN™**

**GRILL**



## DESIGN MULTIFUNCTIONAL

### FĂRĂ TOXINE – THERMOLON VOLT

Acoperire antiaderentă din ceramică, fără PFAS -special concepută pentru aparatele de bucătărie

### INCLUDE

Grătar detașabil/reversibil și farfurii Teppanyaki

**SETARE INDEPENDENTĂ** de încălzire pentru plăcile superioare și inferioare.

Plăcile detașabile sunt sigure în mașina de spălat vase.





**G r a t a r**



**Gatire in stil japonez**



**Preparare gofra**

---

**PLACI  
DETASABILERE  
SI REVERSIBILE**



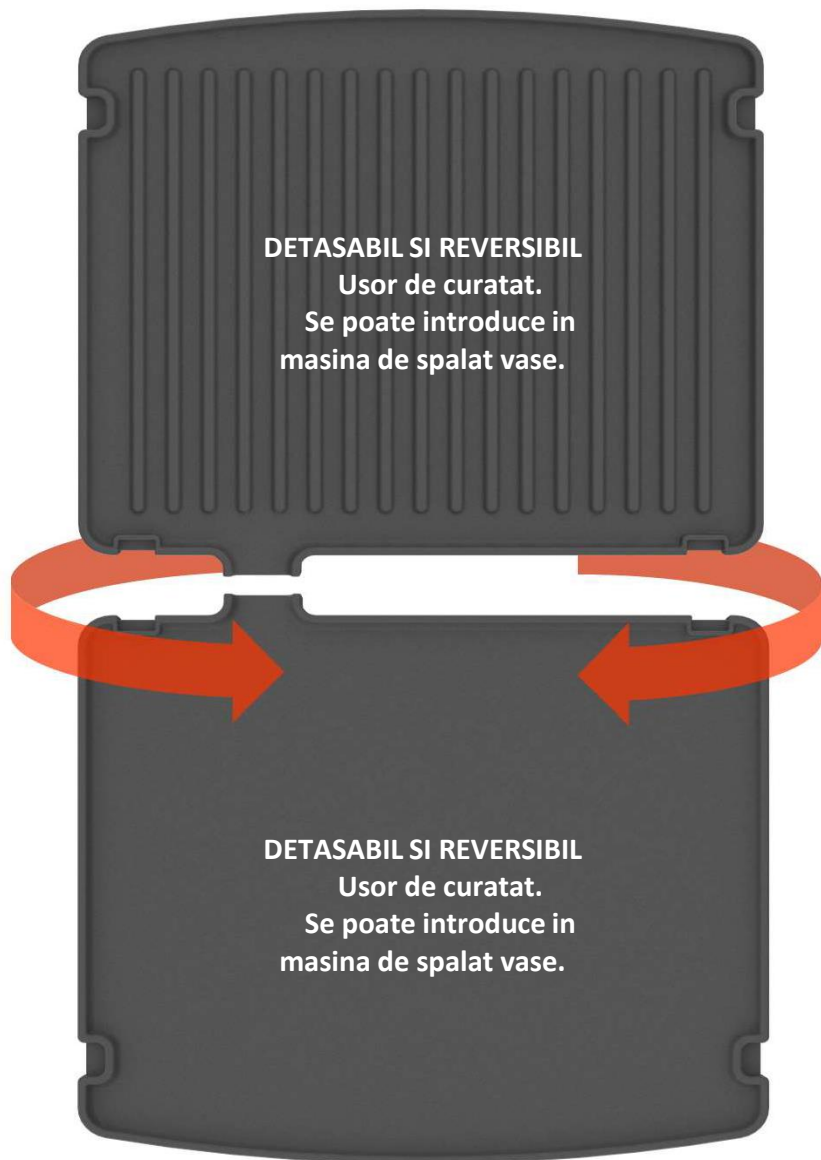

**DETASABIL SI REVERSIBIL**

Usor de curatat.  
Se poate introduce in  
masina de spalat vase.

**DETASABIL SI REVERSIBIL**

Usor de curatat.  
Se poate introduce in  
masina de spalat vase.



Elementele de încălzire în formă de fluturi asigură un transfer excelent de căldură pe toată suprafața plăcii

START | STOP   SEAR   PLATE SELECT   BOTH   TEMP | SHADE +   TIME +  
UPPER   LOWER   WAFFLE   OFF   ON  
GREENPAN  
▶ UPPER BOTH 25 MIN 380°F  
PREHEAT  
▶ LOWER WAFFLE 30 MIN 425°F

Butoane pentru eliberarea  
plăcilor de grătar



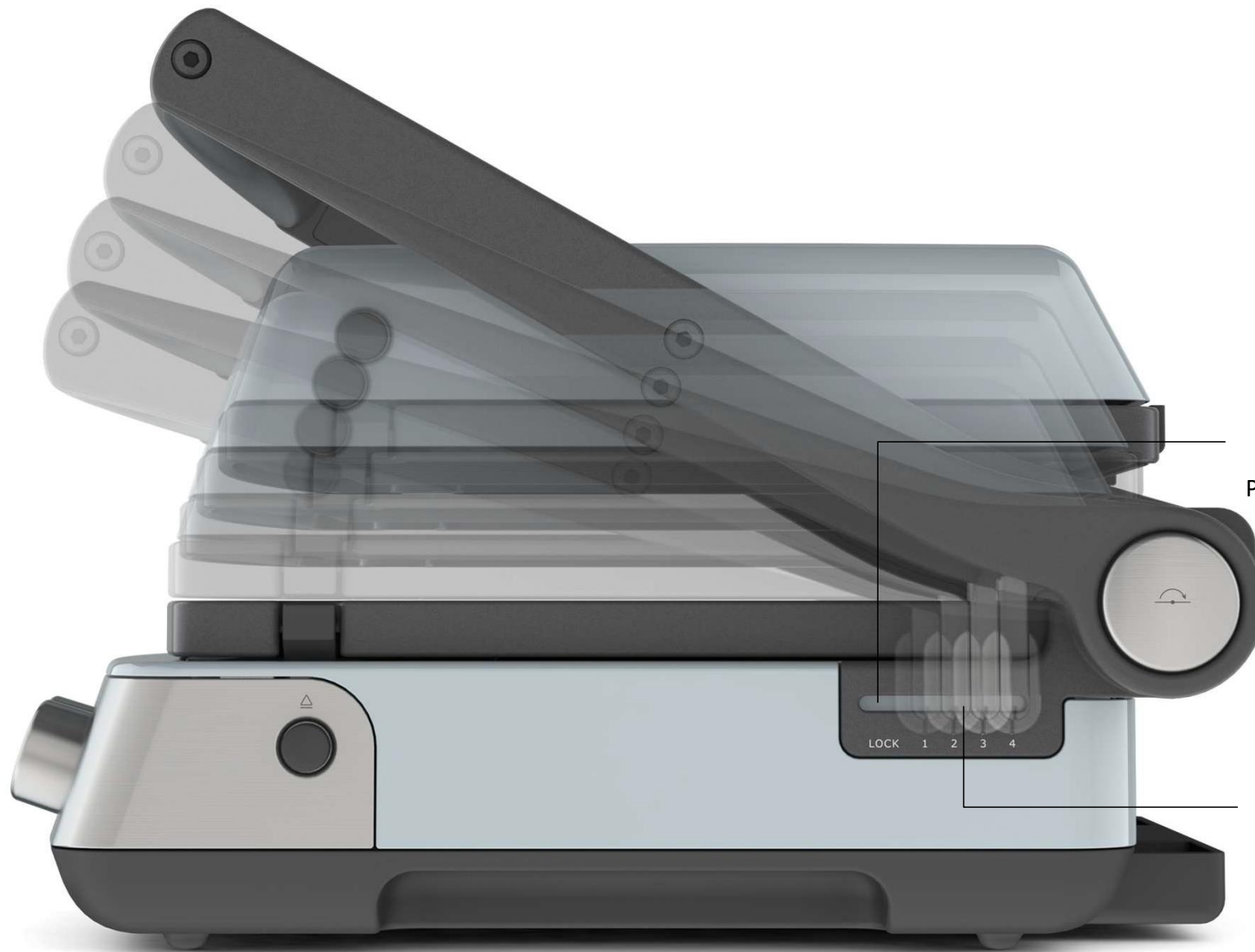

**Setare de blocare a plăcii superioare**  
Pentru a asigura grătarul în timpul depozitării

Placă superioară cu balama, 4 setări de înălțime reglabile

**Deschidere mod BBQ**  
Apăsați butonul pentru a  
deschide grătarul la 180°

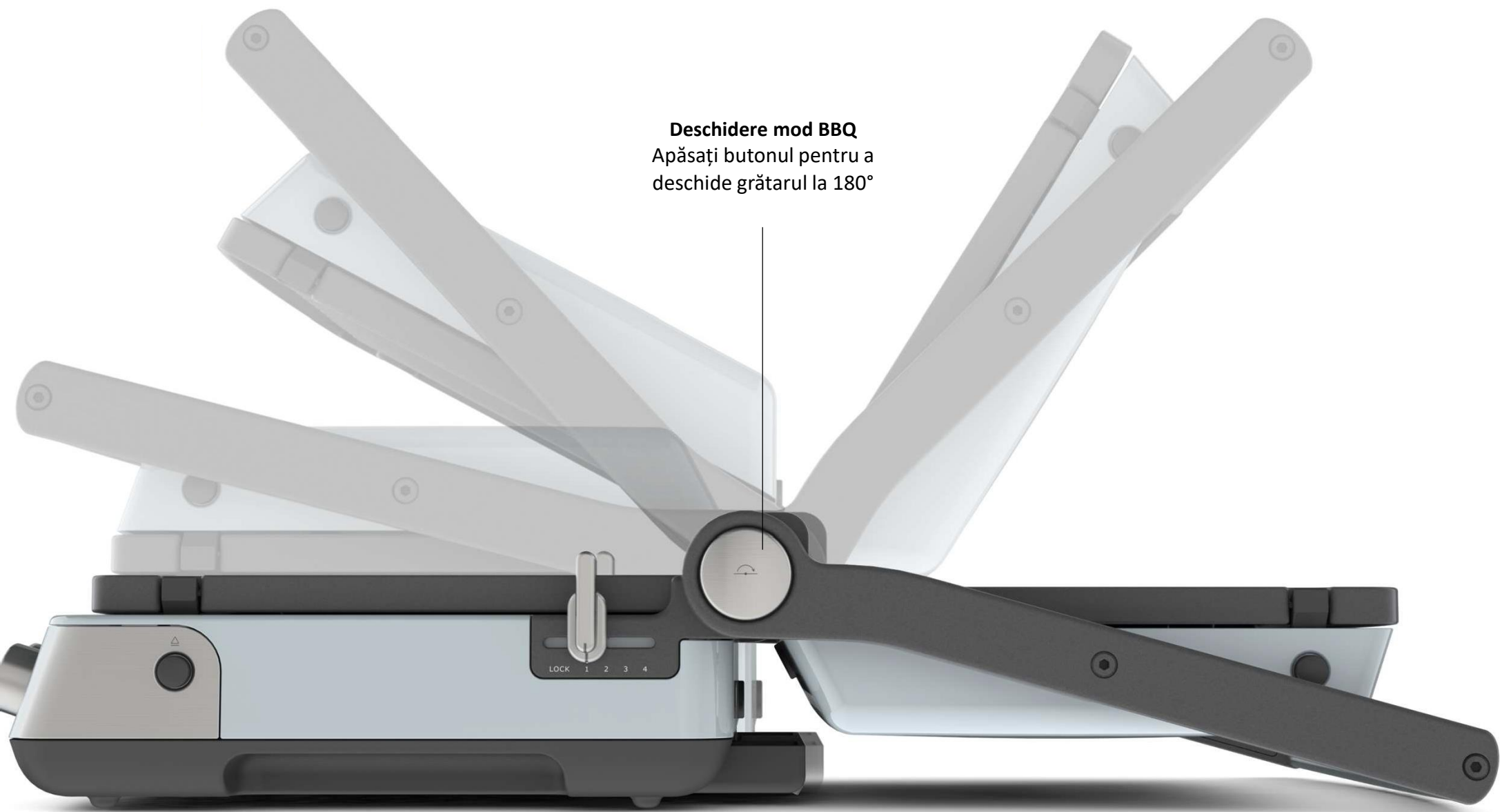



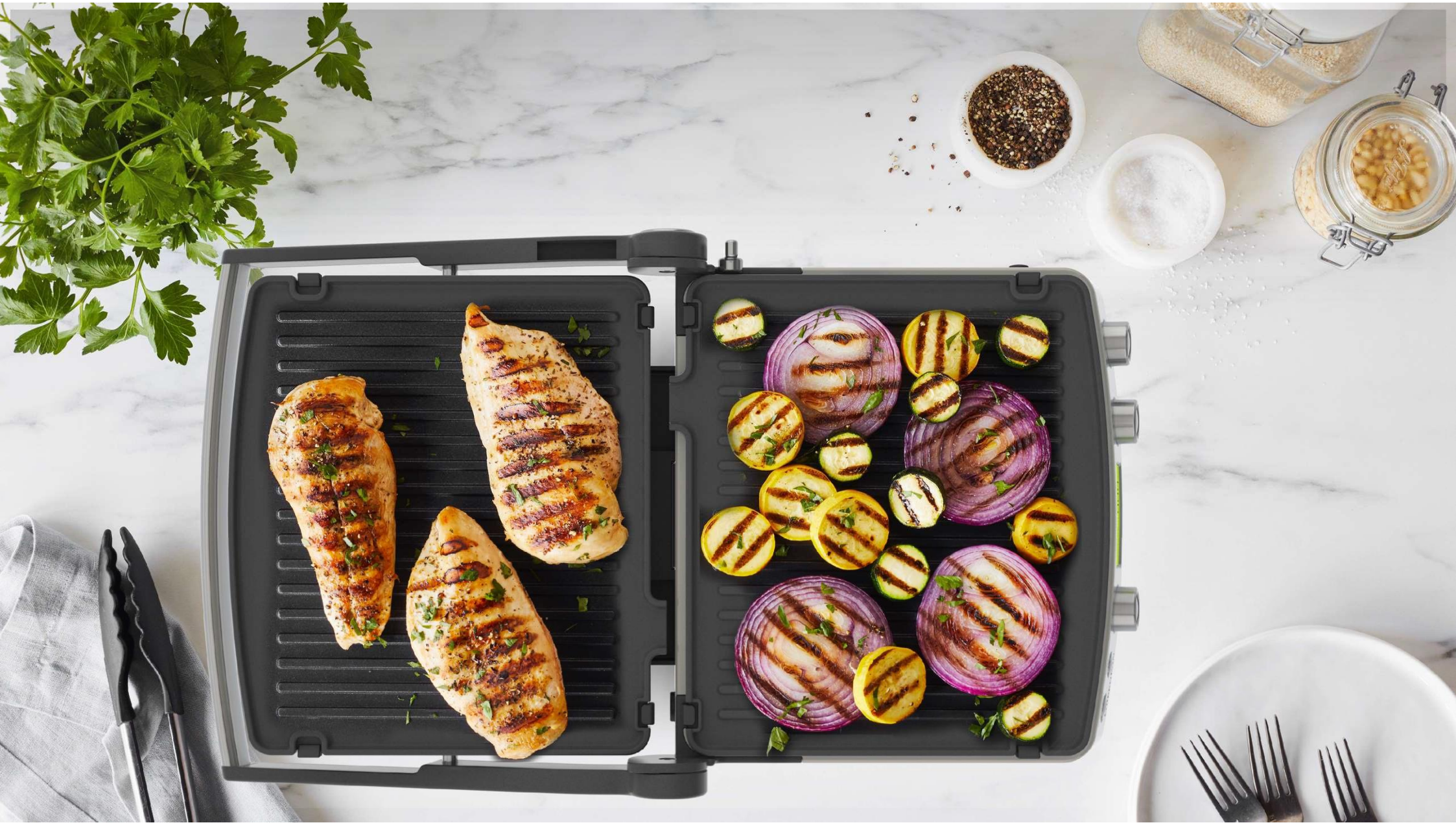

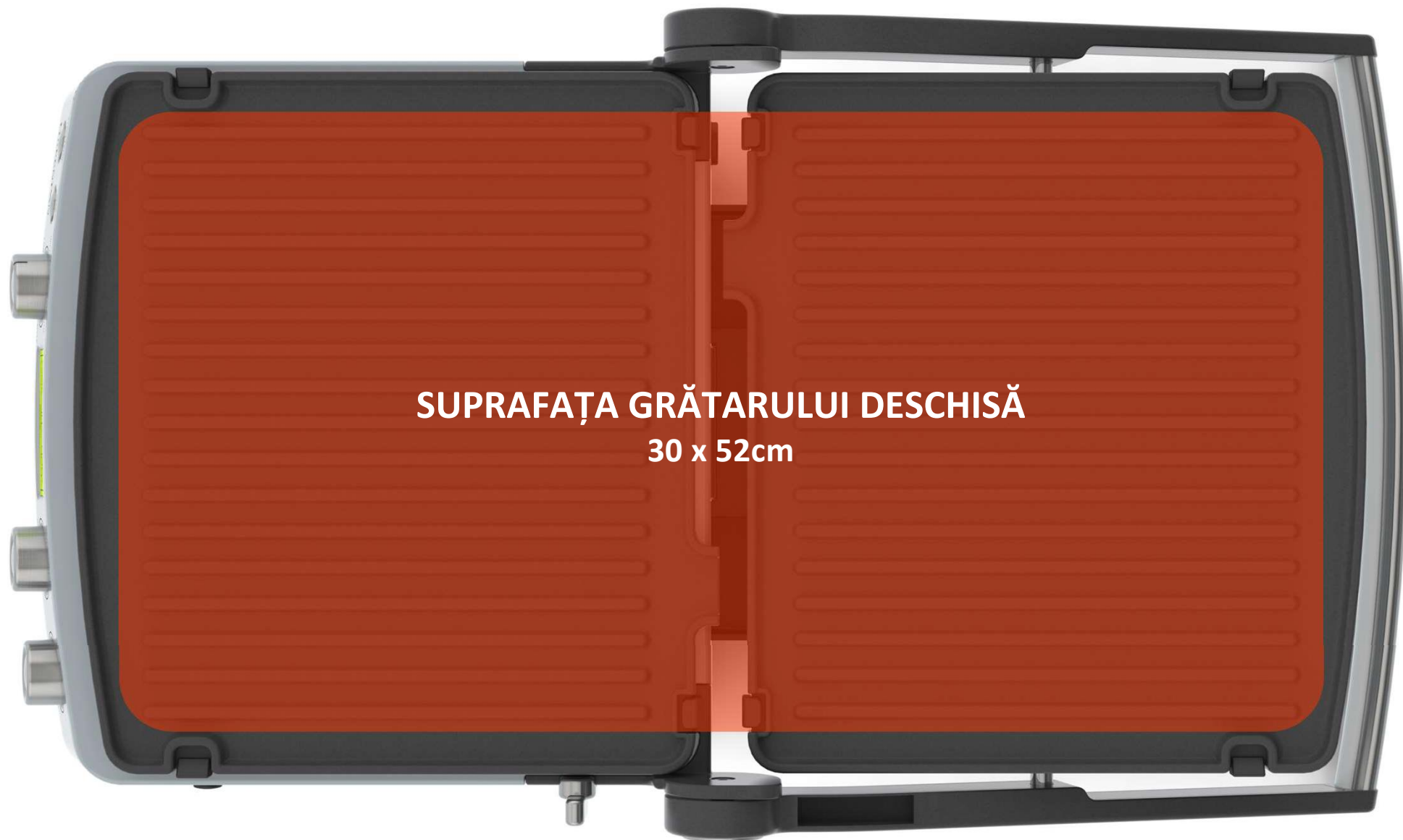

**SUPRAFAȚA GRĂTARULUI DESCHISĂ**  
**30 x 52cm**



**ALEGEȚI GRĂȚAR SAU PLACA TEPPANYAKI(gatire stil japonez)  
ALEGEȚI TEMPERATURA ȘI TIMPUL**



**ALEGEȚI GRĂȚAR SAU PLACA TEPPANYAKI  
ALEGEȚI TEMPERATURA ȘI TIMPUL**



**ALEGEȚI GRĂȚAR SAU PLACA TEPPANYAKI  
ALEGEȚI TEMPERATURA ȘI TIMPUL**



Tava pentru scurgere grasime



Ușor de împachetat și depozitat



Capac cu blocare, reglabil



Atingere **START/STOP**

Buton **SEAR** cu o singura atingere pentru a oferi o crestere scurta a temperaturii

Control independent al temperaturii placii

**Ecran LCD** cu setari de temperatura si timp

Selectati timpul pentru **AMBELE** placi sau independent pentru placile **SUPERIOR** si **INFERIOR**

Selectati temperatura

Maner din inox

**CERAMICA fara PFAS**  
Placi din aluminiu turnat,  
usor de curatat. Pot fi  
spalate in masina de spalat  
vase

Panou din inox

Maner din aluminiu  
turnat







Suport balamale din  
aluminu turnat.

Tava de picurare integrata  
detasabila



# APARAT PENTRU VAFE

## Vafe de clasă mondială

Vă facilităm crearea de vafe. De la umedă și pufoasă la subțire și crocantă, aparatul pune puterea în mâinile tale cu controlul reglabil al nuanței și al texturii!



# APARAT PENTRU VAFE

---

## THERMOLON VOLT

Antiaderență ceramică fără PFAS pentru aparatele de bucătărie

## PLACI DETASABILE

- ✓ Vafe clasice
- ✓ Vafe din Liege și Bruxelles

Pot fi spălate în mașină de spălat vase





Logo incorporat cu  
capac



Placi detasabile cu  
acoperire Thermolon



**Placi detasabile**

**Distributie excelenta a  
caldurii**

**Ecran LCD**  
Cu setari usor de citit

**Butoane**  
cu o singura atingere



**Control reglabil**

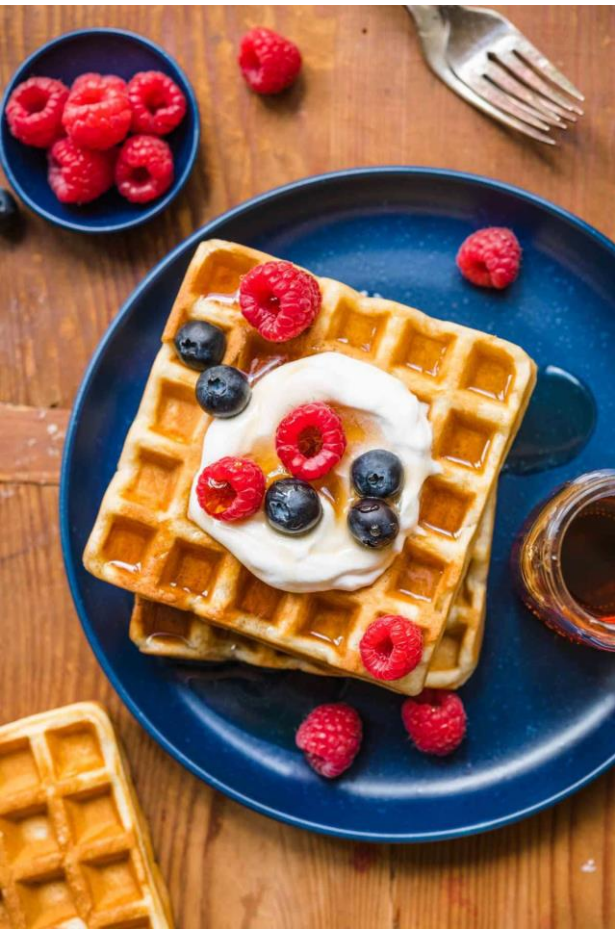

**Belgian**

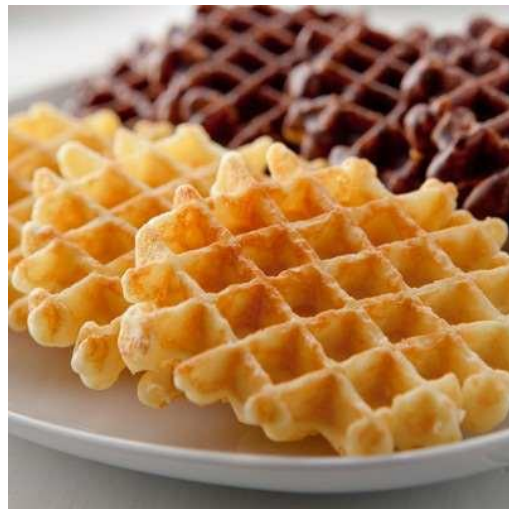

**Classic**



**Brussels**



**Liege**

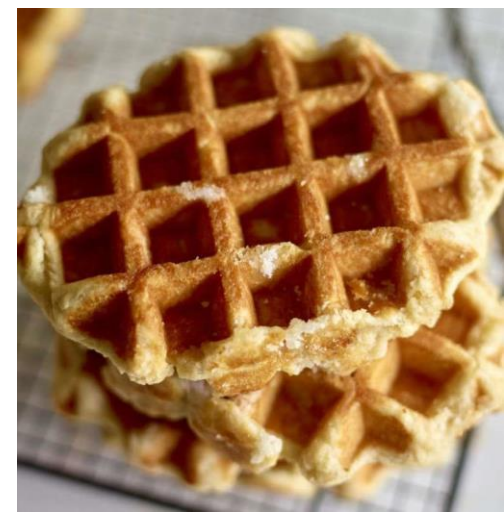

INTRODUCING  
**GreenPan™ Premiere  
 Electrics**

PREORDER  
 NOW!

SHOP ALL SLOW COOKERS

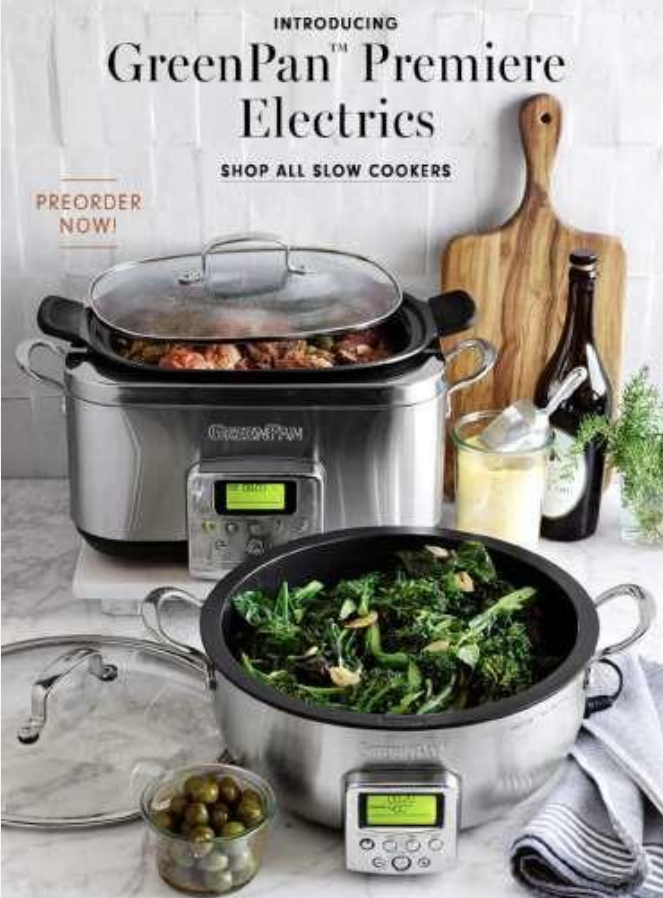

A promotional photograph for the GreenPan Premiere Electric Slow Cooker. The main unit is a stainless steel slow cooker with a digital display and control buttons, filled with a cooked meal. In the foreground, a stainless steel pan with a digital display is filled with fresh green vegetables. The background features a white subway tile wall, a wooden cutting board, and a bottle of wine.

INTRODUCING  
**GREENPAN PREMIERE  
 ELECTRICS**

With a diamond-infused non-toxic ceramic surface, GreenPan's toughest and most durable coating yet, Premiere electrics make Thanksgiving cooking and cleanup a breeze.

- ONLY AT -  
**WILLIAMS  
 SONOMA**

Removable insert for easy maintenance serving



A promotional photograph for the GreenPan Premiere Electric Slow Cooker. The main unit is a stainless steel slow cooker with a digital display and control buttons, sitting on a white marble surface. A stainless steel pan with a digital display is filled with green vegetables. A white bowl of food and a glass of red wine are also visible. The background features a white subway tile wall and a wooden cutting board.

GET THE RECIPES  
 Quinoa Braised Pork & Pineapple  
 Chicken with Olives & Mustard at  
[williams-sonoma.com](http://williams-sonoma.com)

GREENPAN™ PREMIERE STAINLESS STEEL 4-QT. SLOW COOKER NEW & EXCLUSIVE © 2014 WILLIAMS SONOMA  
 GREENPAN™ PREMIERE STAINLESS STEEL 6-QT. ESSENTIAL PAN NEW & EXCLUSIVE © 2014 WILLIAMS SONOMA