

Class 455

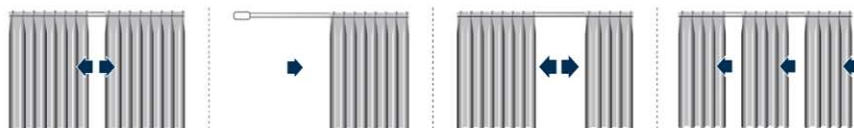

Class 455

UTILIZARE

SISTEM DE PRINDERE PERDELE ȘI DRAPERII PENTRU UZ CASNIC ȘI PROFESIONAL

Pentru drapaje cu dimensiuni de max. 600 cm lungime și 300 cm înălțime și o greutate de max. 10 kg.

Deschidere: centrală / laterală / multiplă / asimetrică

Instalare: tavan / perete

Aționare drapaje: manuală / cu ajutorul sforilor

Sistemul poate fi curbat: la 90° / rază largă.

Glisarea cărucioarelor este asigurată de o folie cu autolubrifiere montată în interiorul profilului.

Ref. 4263	Kg	2 m	4 m	6 m
		8 kg	11 kg	10 kg
		7 kg	9 kg	8 kg
		3 kg	5 kg	4 kg
		3 kg	5 kg	4 kg

CĂRUCIOARE



SPECIFICAȚII TEHNICE

- Șină din aliaj de aluminiu extrudat 6060 T6 UNI 8278
- Lățime profil 13,8 mm – înălțime profil 45 mm
- Canal de glisare: 6 mm
- Rază minimă de curbură: curbe la 90° – 12 cm, curbe cu rază largă – 50 cm
- Culori disponibile: alb RAL 9016 mat, crem, gri satinat, crom, cafeniu, maro, antracit, negru mat
- Cărucioare cu role din termoplastice, rezistente la temperaturi ridicate.

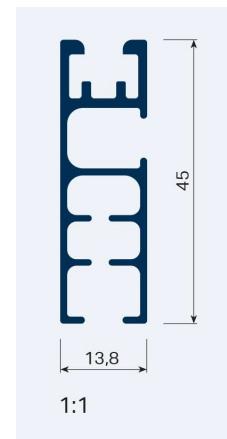

POZIȚIONARE SUPORTURI

L cm		L cm	
140 → 180	3	140 → 160	2
181 → 260	4	161 → 300	3
261 → 340	5	301 → 440	4
341 → 420	6	441 → 580	5
421 → 500	7	581 → 600	6
501 → 580	8		
581 → 600	9		

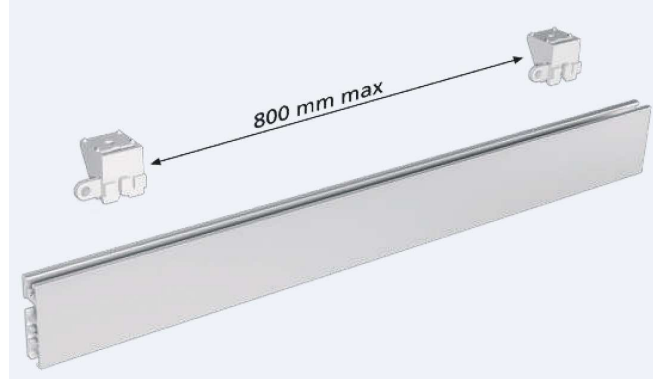

CURBARE



INSTALARE

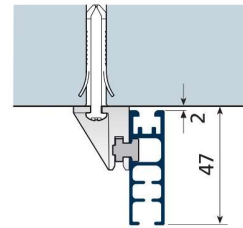

1:3



4086

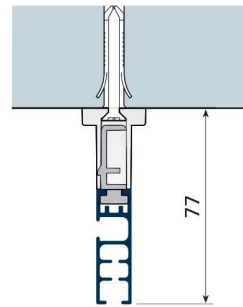

1:3



4339

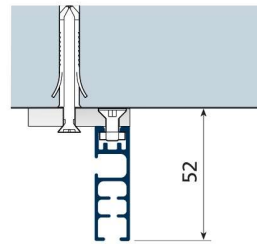

1:3



2277

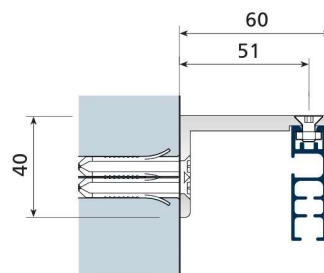
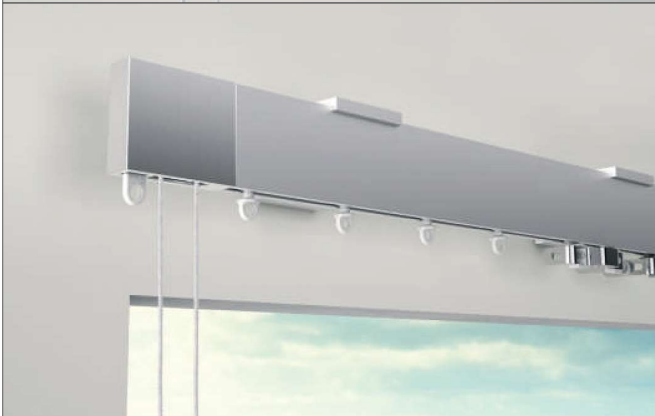

1:3



2262

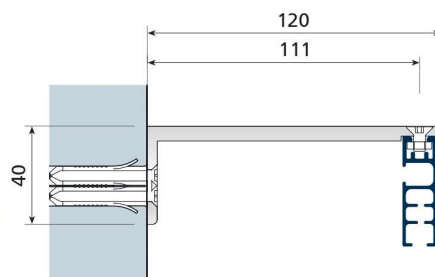

1:3



2263

Class 455

