

AgriEid Digital Weighing Indicator

User Manual

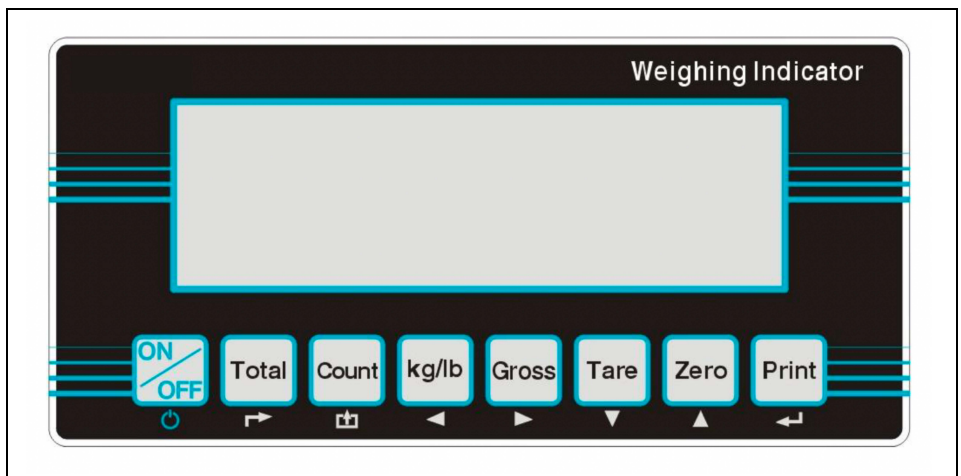



1. Instruction	1
1.1 Main function.....	1
1.2 Technical parameter	1
1.3 Drawing.....	2
1.4 Battery instruction	2
2. Installation and calibration	3
2.1 Power supply connection	3
2.2 Connection of load cell and indicator.....	3
2.3 Communication interface	4
2.4 4~20mA output.....	5
2.5 Relay output signal function	7
3. Basic operation	9
3.1 Keypad	9
3.2 Power on & off.....	11
3.3 Zero operation	11
3.4 Tare operation.....	11
3.5 Accumulation operation	12
3.6 Print.....	12
3.7 Hold.....	13
3.8 Count.....	13
4. Calibration and Parameter setting	14
4.1 Enter setting	14
4.2 Step of calibration operation	15
4.3 Application function parameters setting chart.....	17
5. Output format	22
5.1 Big display continuous sending format	22
5.2 Computer continuous sending format	23
5.3 Serial interface reception command.....	23
5.4 Print format	24
5.5 PC or Big display continuous sending format.....	25
6. Maintenance	26
6.1 Regular error and solution.....	26
6.2 Daily maintain	27
6.3 Restore default parameter.....	27
6.4 Packing list.....	29

1. Instruction

This weighing indicator is designed for bench scale, floor scale, ect.

1.1 Main function

Weighing function:

Zero, tare, accumulation, printing, animal weighing.

Overload remind.

Print format: Date, Time, Net, Tare, Gross

Options:

Pinter

RS232/RS485 serial interface or second display

I/O

4~20mA

1.2 Technical parameter

Accuracy class	3000 e
Resolution	display: 30, 000
Zero stability error	$TK_0 < 0.1\mu V//K$
Span stability error	$TK_{spn} < \pm 6 \text{ ppm//K}$
Sensitivity	$1 \mu V /e$
Input voltage	-30~30mV DC
Excitation circuit	5 VDC, 4 wire connection ,option 6 wire connection Maximum connect 6 load cell of 350Ω
AC power	AC100~250V
Operation temperature	- 10 °C ~ + 40 °C
Operation humidity	≤90%RH
Storage temperature	- 40 °C ~ + 70 °C

1.3 Drawing

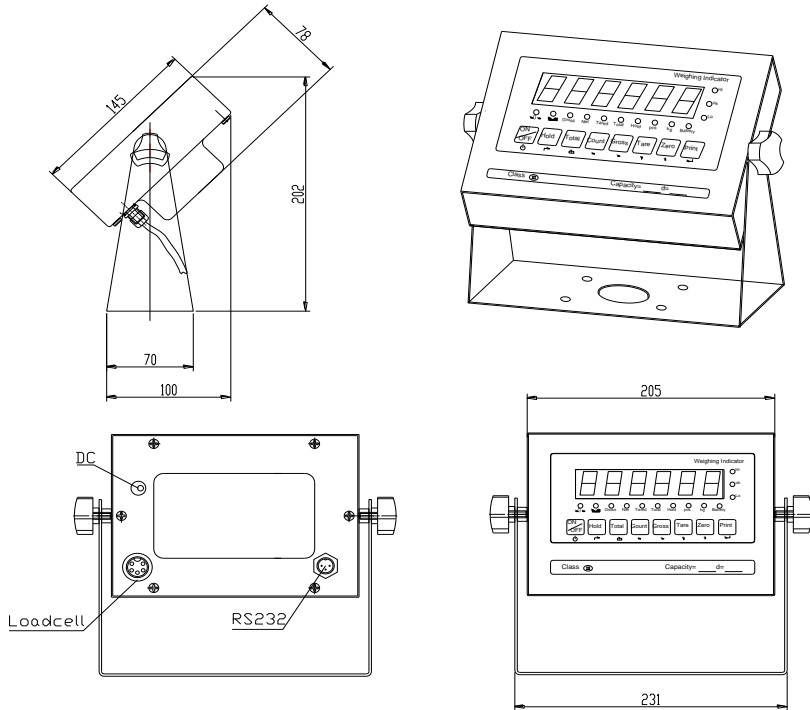

1.4 Battery instruction

1. When you use the internal battery first time, you should charge the battery 10-12 hours, to prevent low voltage resulted from self leakage of battery.
2. The battery voltage could be checked from the light on the right bottom of the display. When low-voltage, "battery marking" flickering and LOBAT shining on LCD display; Red light flickering on LED display, then please recharge the battery.
3. Charge time: 10-12 hours. And it works 40 hours.
4. When the battery light turns green on LED display or "battery marking" all full on LCD display , it means charging finish.
5. If you don't use the indicator for a long time, please take out the battery to protect the indicator from the battery leakage.

2. Installation and calibration

2.1 Power supply connection

The indicator is powered by adapter, you plug the adapter directly into the “DC” pin at the back cover the indicator is ok.

2.2 Connection of load cell and indicator

The indicator can connect with 6 load cell of 350Ω at most, 4 wire or 6 wire load cell both ok.

There are two methods connection between load cell and indicator

A. quick disconnect, as below:

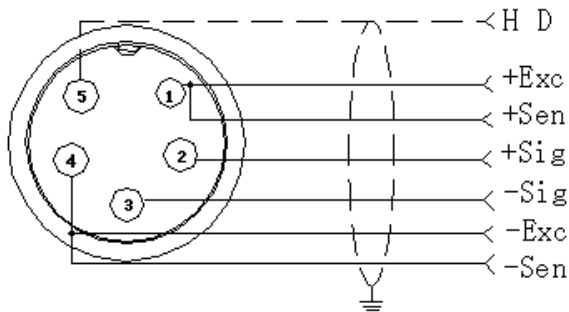

B. Terminal trip connection (inner connection)

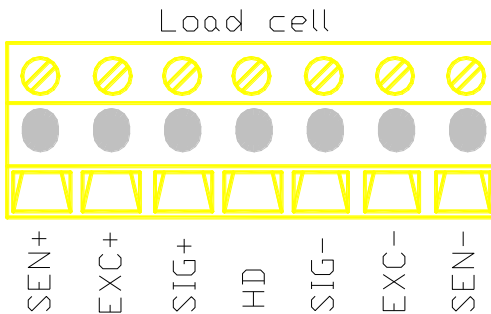

1. The exciting voltage for the load cell is 5VDC, the largest output current 120mA, maximum connect 6 pcs 350Ω load cell;
2. Load cell (or the signal cable for the junction box) is connected with 6 bit terminal trip (Load cell) on the printed circuit board of weighing indicator;
3. Open Weighing indicator back cover, insert signal cable to the terminal trip (Load cell), and make sure the screw is fixed tightly.

2.3 Communication interface

RS232 : DB9 Pin or 3 Pin

DB9 definition

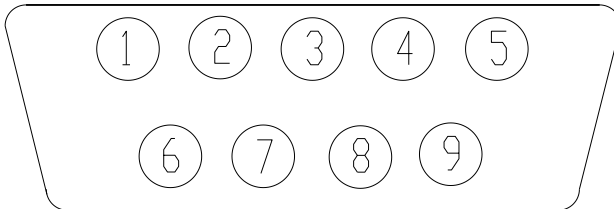

Pin function and definition as bellows:

DB9 joint	Definition	Function
2	TXD	Transmit data
3	RXD	Receiving data
5	GND	Ground interface

Note: if RS485 A and B, The connection pin is 2 and 3 pin.

3 Pin definition

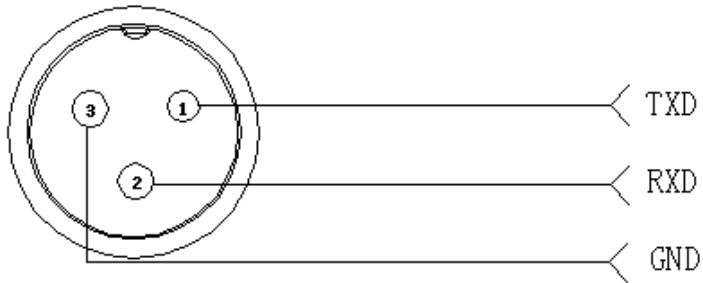

Inner connection:

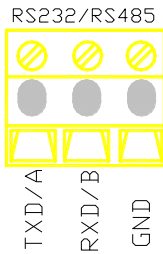

Pin definitions:

Pins	Definitions	Function
RS232	TXD	Transmit data
	RXD	Receiving data
	GND	Ground
RS485	A	RS485 output "A" port
	B	RS485 output "B" port

2.4 4~20mA output

Technical parameters:

Resolutions: 1/1000

Outside Load: 0-500Ω

Connection:

1. Inside connection: 4~20mA, analog input + port connect with "Iout" of J602, analog input - port connect with "GND" of J602.
2. Outside connection: 4~20mA, analog input + port connect with "1" pin of DB9, analog input - port connect with "6" pin of DB9.

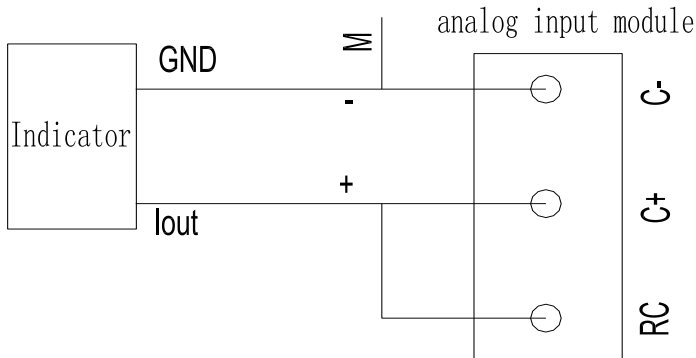

Testing :

Connect the 4~20mA to analog input module, then you can read the value of 4~20mA by CPU at analog input channel.

If you do not have analog input module, adjust the multimeter to the current stalls, series connection with the 4~20mA.

Calibration:

1. Press "Print" and "Hold" go to C32, show [out-4], the output current should be 4mA.
2. If Press [↑] show [out-5], Press [↓] show [out-20] , the output current should be 20mA.

Function instruction:

4~20mA correspond to Zero ~Max. capacity. After press "TARE", the weight will start from 4mA. SET C31=0, 0~20mA output mode; C31=1 4~20mA output mode.

If you need 0~5V output, Set C31=0, Then connect 250Ω at the two ends of current output., will get 5voltage at resistance two ends.

2.5 Relay output signal function

The indicator can output 4 signal, connect with the outside equipment the indicator can perform automatic control function and upper limit and lower limit alarm function. Perform function through setting C33, 4 signals.

As below

	Output port	Port definition	Function
C33=0	Out1	Close output function	No output signal
	Out2	Close output function	No output signal
	Out3	Close output function	No output signal
	Out4	Close output function	No output signal
C33=1	Out1	Open overload control function	Output overload control signal
	Out2	Open compliance control function	Output compliance control signal
	Out3	Open underload control function	Output underload control signal
	Out4	Open stable control function	Output stable control signal
C33=2	Preserved, no function.		
C33=3	Preserved, no function.		

For example:

Check weigher application. Connect indicator with yellow, green, red 3 lights. Yellow light on when overload, if ok the green light on. If underload red light on. And can connect with buzzer. There would be alarm remind when overload.

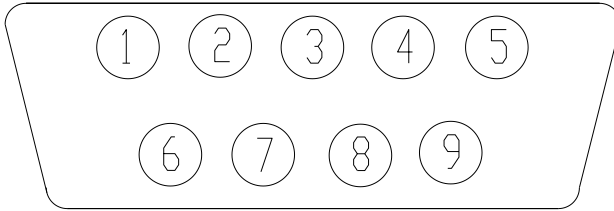

DB9 pin	definition	port
1 pin	1 st output signal pin	Out1
6 pin	1 st output signal pin	Out1
2 pin	2 nd output signal pin	Out2
7pin	2 nd output signal pin	Out2
3 pin	3 rd output signal pin	Out3
8 pin	3 rd output signal pin	Out3
4 pin	4 th output signal pin	Out4
9 pin	4 th output signal pin	Out4

Inner connection pin definitions

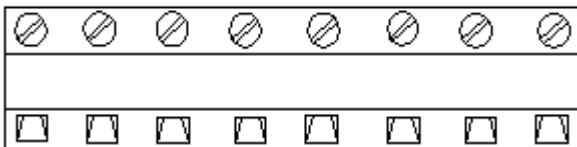









01 01 02 02 03 03 04 04

3. Basic operation

3.1 Keypad



Keys function

keys	Key name	Key function
	Print	Print
	Zero	Zero the weight within zero range
	Tare	At Gross mode, get the tare weight. At Net mode, clear the tare, get the Gross
	Gross weight	At Net mode, check the Gross, after 3 seconds back to Net automatically
	Kg/lb convert	Convert between kg and lb
	Counting	Counting operation
	Accumulation Calibration	1. Accumulation 2. Press and hold with the PRINT Button to access calibration and accumulation settings etc
	Power on/off	Press 2 seconds to power on or power off

3.2 Power on & off



Press  2 seconds to power on or power off, after power on the indicator show "000000-999999". After self inspection, it goes to the weighing mode. Pls. check it whether 6 bits LED/LCD display and the status light is good or not.

3.3 Zero operation

1. Initial zero setting

When power on the indicator, if the weight on the scale is within the initial zero range, indicator show zero automatically.

2. Manually Zero setting

When the scales is stable, you can zero the weight within range by





press  keys.

3.4 Tare operation





When the scales is stable, Press  key, the gross weight is tared, indicator show the Net weight, the "Net" "tared" status light is on. At tare mode, Press "TARE" key, clear the tare weight, the indicator will show the gross weight.

3.5 Accumulation operation

At Zero mode, load weight till stable, Press  go to accumulation mode, "Total" light on, display "n 001", and then display loaded weight; unload the weight, back to zero, load the second weight again till stable. Press  display "n002" then display the second loaded weight. Repeat it again and again, maximum 999 times.

Check the accumulation

Press  and hold it then press , display "n**", (it is the accumulating times) then show total weight. there are 8 digits totally. It shows the first 4 digits then the last 4 digits. For example, the first 4 digits is "0012", the last 4 digits is "34,56" It means the actual weight is "1234.56".

EXIT the accumulation function

When the indicator show the last 4 digits, Press  hold it, the indicator show "clr n", it means don't clear the total Weight, Press "PRINT" key to exit it; if you want to clear total weight, Press "ZERO" or "TARE" key, "clrn" change to "clry" it means clear total weight, then Press "PRINT" to clear the total weight and exit accumulating mode.

3.6 Print

If the weighing is stable, after connect with printer, press "PRINT" can print the weight. Note: at tare mode, print with tare. if negative weight, can not print. Set C30 for time format.

3.7 Hold

There are two different hold function. Peak hold function and data hold function. And the setting is different accordingly.

option: 0=close hold function

1=Peak hold /2=Data hold

3=Auto hold/4=Animal hold

Instruction:

Peak-hold: it shows the max. data,

mainly application for materials testing, such as tension and pulling force.

Date-hold: it shows current weight value. Mainly application for animal weighing.

Auto-hold: When the pet keep stable on the scale, the indicator will automatically “ Hold” for 6 seconds.

Animal-hold: Press” Hold” key, the indicator will show” LOC” for 3 seconds, the “ hold” light is on, During the 3 seconds, the indicator will catch the average weight and show it.

Press” HOLD” key again to exit it.

3.8 Count

1. At weighing mode, load the weights on the platform scales, Press” Count” the indicator show” PCS 0” press” Zero” key input the quantity, press” Print” to confirm it.

2 . Load the goods on the platform scales, then the indicator will show the quantity.

2. Press” Count” back to weighing mode.

3. If you want to weigh different goods, at weighing mode, put the sample on the platform scales, press” Count” the indicator show”0” Press “Print” hold it and then press “Count” the indicator show” PCS 0”, press “Zero” input the sample quantity, press “ Print” to confirm it. Then repeat the step 2 and 3.

4. Calibration and Parameter setting

4.1 Enter setting

There have two methods to enter the setting menu:

1. Put the switch “MARK” to “On” position, enter calibration.

And when calibration is finish. Put the switch “ MARK” to “off” position.

Then add the sealing screw at the back of indicator.

2. when the switch “ MARK” is on position, press the “ ←” hold it and then press” ↵” enter calibration.

The key functions in setting:

 **ENTER**

 **UP**

 **DOWN**

 **LEFT**

 **RIGHT**

 **BACK**

 **EXIT CALIBRATION**

 **POWER**

4.2 Step of calibration operation

According to the second method which can enter setting menu, C01-C39

step	Method of operation	display	Remark
1		[C01]	After you enter calibration mode, it display [C01]
2	press ←	[C1 1]	Weight unit option : 1=kg 2=lb
3	press ← press ← press ↑ or ↓	[C02] [C2 0] [C2 2]	Set decimal digits option: 0/1/2/3/4 Select decimal digit example: two decimal point: [C02 2]
4	press ← press ← press ↑ or ↓	[C03] [C3 1] [C3 5]	Set graduation option: 1/2/5/10/20/50 Select required graduation example: graduation 5: [C03 5]
5	press ← press ← press ↑ or ↓ / ←	[C04] [01000.00] [01000.00]	Max capacity example: max weighing 1000lb: [1000.00]
6	press ← press ← press ↑ press ←	[C05] [C5 0] [C5 1] [CAL 9] [0000.00]	Zero calibration Option 0=no need zero calibration 1=need zero calibration calibration zero please choose 1 and ensure scale is empty and “stable” light is on Ensure zero calibration, countdown. Till show[0.00](example for two decimal point).

7	<p>press ←</p> <p>press ←</p> <p>press ↑ or ↓</p> <p>press ←</p> <p>press ↑ or ↓</p> <p>press ←</p>	<p>[C06]</p> <p>[C6 0]</p> <p>[C6 1]</p> <p>[SPAN]</p> <p>[1000.00]</p> <p>[0800.00]</p> <p>[CAL 9]</p> <p>.....</p> <p>[0800.00]</p> <p>[CAL End]</p>	<p>calibration option:</p> <p>0=No need calibration</p> <p>1= need calibration</p> <p>Load weights on scales according to max. capacity. Suggest close to the max capacity, at least 10% of max. capacity.</p> <p>For example: the weight is 800lb</p> <p>As bellow:</p> <p>Input the 0800.00, count down , then indicator shows 0800.00 , calibration is over.</p> <p>If you want to set application function parameter, press “ ”. if you want to exit press “ ”</p>
8	<p>press ←</p> <p>press ←</p> <p>press ↑ or ↓</p>	<p>[C07]</p> <p>[C7 0]</p> <p>[C7 1]</p>	<p>Default parameters setting option:0=non-restore default parameters</p> <p>1=restore default parameters</p> <p>Note: after the above parameters setting finish, please do not set default parameters to avoid the original setting parameters is lost.</p>

4.3 Application function parameters setting chart

Function	Setting Item	parameters setting and instruction
Warning tone	C08 Warning tone	options: 0 = close warning tone 1 = open warning tone
Automatic power off	C09 Automatic power off	option: 0=close auto power off 10= power off automatically if no change within 10 minute. 30= power off automatically if no change within 30 minute. 60= power off automatically if no change within 60 minute.
Power saving setting	C10 Power saving setting	LED Version: option: 0= close power saving setting 3= close display if no change within 3min. 5= close display if no change within 5 min. LCD Version: 0=Close the backlight 1= backlight when the weight change or press the keyboard 2=constant backlight
Hold function	C11 Hold mode	option: 0=close hold function 1=Peak hold /2=Data hold 3=Auto hold /4=Animal hold Instruction: Peak-hold: it shows the max. data, mainly application for materials testing, such as tension and pulling force. Date-hold: it shows current weight value. Mainly application for animal weighing.

Animal hold sample time	C12 Animal hold sample time	option: 3=3 second 5=5 second
Upper/lower limit alarm	C13 Upper limit alarm value	You can set it within the max. capacity limit
	C14 Lower limit alarm value	
Inner Code display	C15 Check inner code	enter C15 to check the inner code

Date and time	C16 Date	Enter C16, you can set the date, from left to right: year/month/day
	C17 Time	Enter C17, you can set the time from left to right: hour/min./sec.
Communication setting	C18 Serial data method interface output	option: 0= Close serial interface data output 1=Continuous sending, connect big display 2=Print method, connect printer. 3=Command request method , connect computer. 4=PC continues sending format, connect computer. 5=PC/ big display continuous sending format.
	C19 Baud rate	option: 0=1200/1=2400/2=4800/3=9600
Zero range	C20 Manually zero range	Option: 0= close manually zero setting 1=±1% max capacity

		2= \pm 2% max capacity
	C21 Initial zero range	option: 0= no initial zero setting 1= \pm 1% max capacity 2= \pm 2% max capacity 5= \pm 5% max capacity 10= \pm 10% max capacity
Zero tracking	C22 Automatically zero tracking range	Options: 0= close zero tracking 0.5= \pm 0.5d 1.0= \pm 1.0d 2.0= \pm 2.0d 3.0= \pm 3.0d 4.0= \pm 4.0d 5.0= \pm 5.0d Note: 1. d = division 2. the zero tracking range can not bigger than manual zero range.
	C23 Automatically zero tracking time	Options: 0= close zero tracking time 1= 1 second 2= 2 seconds 3= 3 seconds
Overload range	C24 Overload range	option : 00= close overload range 01d~99d remark: d =division
Negative display	C25 Negative display range	Option: 0=-20d 10=10% max. capacity 20=20% max. capacity 50=50% max. capacity 100=100% max. capacity

Standstill time	C26 Standstill time	Option: 0= quick 1= medium 2= slow
	C27 Standstill range	Option: 1= 1d 2=2d 5=5d 10=10d D= division
Digital filter	C28 Dynamic filter Instruction : Dynamic filter is collecting the data filter before loaded weight stable. When loaded weight easily shaking (for example animal) , you can set this filter to make weight display more stable	option: 0= close dynamic filter 1=1 digital filter strength 2=2 digital filter strength 3=3 digital filter strength 4=4 digital filter strength 5=5 digital filter strength 6=6 digital filter strength Note : Pls setting dynamic filter strength carefully, the No. is bigger, more stable. if the loaded weight shake not too much. The setting is less than 3
	C29 Noise filter	option: 0=close noise filter 1=1 digital filter strength 2=2 digital filter strength 3=3 digital filter strength
	C30 Print time and date	C30=0 yy.mm.dd C30=1 mm.dd.yy C30=2 dd.mm.yy C30=3 yy.mm.dd
Analog output setting	C31 output type	C31=0 0~20mA ouput C31=1 4~20mA output

4~20mA current calibrate	C32 calibrate current	Refer to 2.5
Relay output setting	C33 Relay output	C33=0 close relay output C33=1 Open relay output function 1 C33=2 Preserved menu C33=3 Preserved menu
Muti communication add.	C34 Communication add.	C34= 0~99 Add. Code
Wireless communication	C35	C35=0~99 signal
Gravity of calibration location	C36	C36=9.7000~9.9999
Gravity of destination Version No.	C37 C38	C37=9.7000~9.9999
Preserved menu	C39	
Print mode	C41	C41=0 auto mode C41=1 gross mode C41=2 tare mode See 5.4 Print format parts in detail
Print carriage return	C42	C42=0~9
Space Print	C43	C43=0~9
Date Print	C44	C44=0 not print date C44=1 print date
Time Print	C45	C45=0 not print time C45=1 print time

5. Output format

5.1 Big display continuous sending format

Output continuous format																		
S	S	S	S	X	X	X	X	X	X	X	X	X	X	X	X	X	C	C
T	W	W	W														R	K
X	A	B	C														S	S
1	2			3						4						5	6	

State A			
Bits0,1,2			
0	1	2	Decimal point position
0	1	0	XXXXXXX
1	1	0	XXXXX. X
0	0	1	XXXX. XX
1	0	1	XXX. XXX
Bits3,4			Division
0	1		X1
1	0		X2

State B	
BitsS	function
Bits0	gross=0, net=1
Bits1	Symbol: positive =0,negative =1
Bits2	Overload(or under zero)=1
Bits3	dynamic=1
Bits4	unit: lb=0, kg=1
Bits5	Constant 1
Bits6	Constant 0

State C			
Bit2	Bit1	Bit0	unit
0	0	0	Kg or lb
0	0	1	g
0	1	0	t
Bit 3			printing=1
Bit 4			Extend display=1
Bit 5			Constant 1
Bit 6			Constant 0

5.2 Computer continuous sending format

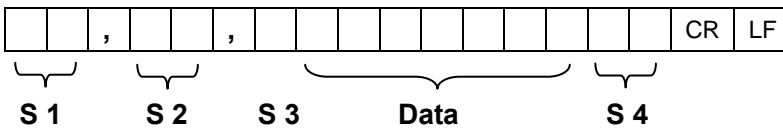

- S1: weight status, ST= standstill, US= not standstill, OL= overload
- S2: weight mode, GS=gross mode, NT=net mode
- S3: weight of positive and negative, “+” or “-“
- S4: “kg” or “lb”
- Data: weight value, including decimal point
- CR: carriage return
- LF: line feed

5.3 Serial interface reception command

RS232COM serial interface can receive simple ASCII command.

Command word and role as follows:

Command	NAME	Function
T	TARE	Tare operation
Z	ZERO	Zero operation
P	PRINT	Print the weight
R	Reply	Reply the weight
G	Gross	Check gross weight at net weight mode

R command receive data format

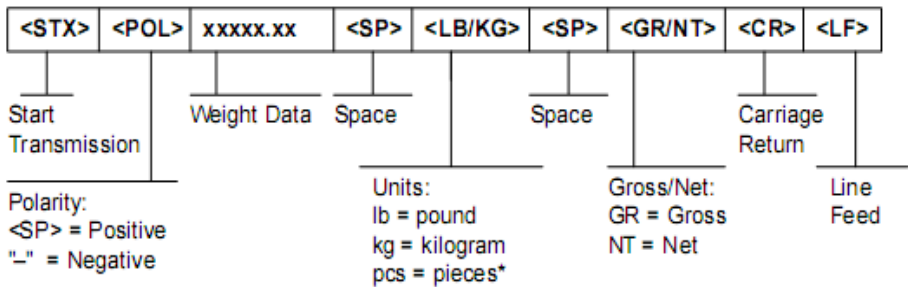

5.4 Print format

Tare mode:

Date: XX.XX. XX
 Time: XX: XX: XX
 NET XX.X lb
 TARE XX.X lb
 GROSS XXX.X lb

Gross mode:

Date: XX.XX. XX
 Time: XX: XX: XX
 GROSS XXX.X lb

5.5 PC or Big display continuous sending format

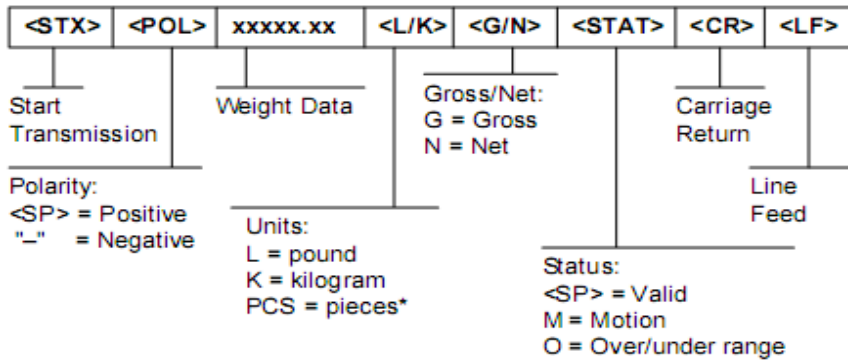

6. Maintenance

6.1 Regular error and solution

ERROR	REASON	SOLUTION
UUUUUU	1. Overload 2. Wrong connection with load cell 3. Load cell has quality problem.	1. Reduce the weight 2. Check load cell connection 3. Inspection load cell. Check the input and output
nnnnnnn	1. Wrong connection 2. Load cell has quality problem	1. Check load cell connection. 2. Check input and output resistance to judge it is good or not.
ERR1	During calibration, not input the weights or the weight is overload	Input the correct weights
ERR2	During calibration, the weights is below than Min. required weights	The calibration weights Minimum is 10% of Max. cap. Recommend 60%-80% of Max. Cap.
ERR3	During calibration, the input signal is negative	1. Check the connection is correct 2. Check load cell is no problem 3. Recalibration if still wrong change the PCB
ERR4	During calibration, the signal is unstable	After the platform is stable, start calibration
ERR5	EEPROM error	Change PCB

ERR6	Exceed zero range	Remove the load
------	-------------------	-----------------

6.2 Daily maintain

1. Protect the indicator from strong sunlight to prolong the using life
2. Good connection between load cell and indicator. Far from away from strong electric field, magnetic field.
3. Power off the indicator when lightning
4. Power off the indicator firstly before plug and unplug

6.3 Restore default parameter

Enter to calibration, Set C07=1. Press" ←" then press" ↑" to exit saving setting. All parameter will back to default

Note : Pls. do not restore default parameter easily if you are not professional staff or not yet calibrate the scales.

Default parameter

Parameter	instruction	Default
C01	Calibration	1
C02	Decimal digits	0
C03	Resolution	1
C04	Max. capacity	10000
C05	Empty calibration	0
C06	Capacity calibration	0
C07	Restore default	0
C08	Warning tone	1
C09	Power-off automatically	0
C10	Power saving mode	0

C11	Hold function	0
C12	Animal hold sample time	3
C13	Upper limit alarm	000000
C14	Under limit alarm	000000
C15	Inner code	
C16	Date setting	
C17	Time setting	
C18	Serial interface data output	0
C19	Serial interface Baud rate	3 (9600)
C20	Zero manually	10
C21	Initial zero	10
C22	Zero tracking range	0. 5
C23	Zero tracking time	1
C24	Overload range	9
C25	Negative range	10
C26	Standstill time	1
C27	Standstill range	2
C28	Dynamic filter	0
C29	Noisy filter	2
C30	Print format	0
C31	Analog signal options	1
C32	4~20mA testing	4
C33	Relay output setting	1
C34	Muti PC communication add.	0
C35	Wireless communication channel	6
C36	Calibration location gravity	9.7936
C37	Destination gravity	9.7936
C38	Version No. check	
C39	Reserved menu	

6.4 Packing list

Packing list

S/N	ITEM	NAME	UNIT	QTY	PACKING
1	Weighing indicator		PCS	1	
2	Plastic bag		PCS	1	
3	bag		PCS	1	
4	Adapter	China/DC9V	PCS	1	
		US/DC9V	PCS	1	
		UK/DC9V	PCS	1	
		EU/DC9V	PCS	1	
		AU/DC9V	PCS	1	
		OTHERS	PCS	1	
5	User manual		PCS	1	
6	RS232	3 PIN OR DB9	PCS	1	
7	Load cell plug	5 PIN Quick disconnect	PCS	1	
8	Signal cable	Φ5/3 core shield signal cable	PCS	1	
9	Power cable	3 coreΦ0.75mm	PCS	1	
10	Bracket	Wall-mounted	PCS	1	
11	Certificate		PCS	1	
12	Packing list		PCS	1	



Safety Instruction

For safety operation, pls. follow the safety instruction.



WARNING

Setting, calibration, inspection and maintain of the indicator is prohibited by Non-professional staff.



WARNING

Pls. make sure the weighing display have good ground in using.

ATTENTION



OBSERVE PRECAUTIONS
FOR HANDLING
ELECTROSTATIC
SENSITIVE DEVICES



WARNING

The indicator is the static and sensitive equipment, cut off the power during electrical connections, internal components touched by hand is prohibited, and please take the measure of anti-static.