

Congratulations,

By purchasing the **APPIA II** you have made an excellent choice.

The purchase of a professional espresso coffee-maker involves various elements of selection: the name of the manufacturing firm, the machine's specific functions, its technical reliability, the option of immediate and suitable servicing, its price. You certainly evaluated all these factors and then made your choice: the **APPIA II** model.

We think you have made the best choice and after every coffee and cappuccino you will be able to assess this.

You will see how practical, convenient and efficient working with **APPIA II** is.

If this is the first time you have bought a **Nuova Simonelli** coffee machine, welcome to high quality coffee-making; if you are already a customer of ours, we feel flattered by the trust you have shown us.

Thanks of the preference.

With best wishes,

Nuova Simonelli S.p.a.



APPIA II

TECHNICAL CHARACTERISTICS

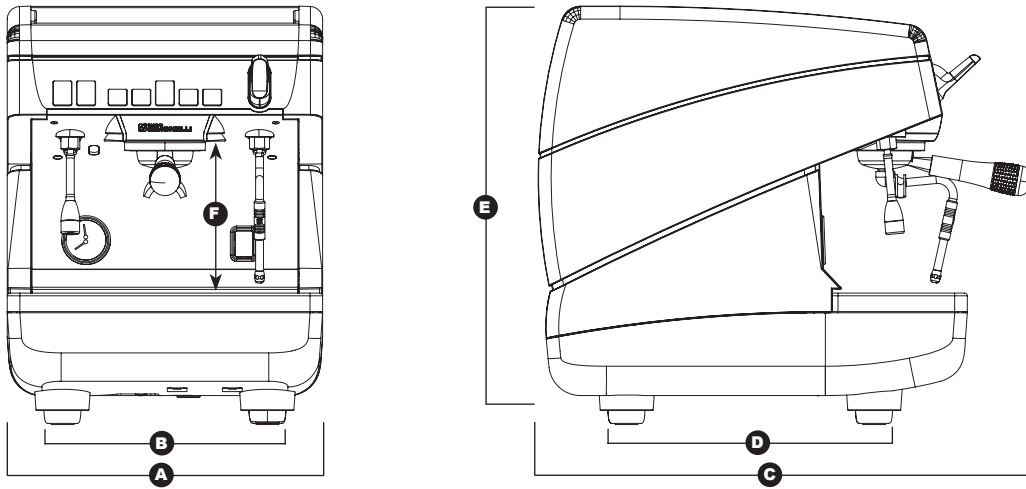

	1 Group 110V		1 Group 220V	
NET WEIGHT	35 kg	77 lb	35 kg	77 lb
GROS WEIGHT	43 kg	94.8 lb	43 kg	106 lb
POWER	1700 W	1700 W	2000 W	2000 W
DIMENSIONS	A 400 mm	A 15.74"	A 400 mm	A 15.74"
	B 310 mm	B 12.2"	B 310 mm	B 12.2"
	C 545 mm	C 21.46"	C 545 mm	C 21.46"
	D 360 mm	D 14.17"	D 370 mm	D 14.17"
	E 530 mm	E 20.86"	E 530 mm	E 20.86"
	F 180 mm	F 7 1/16"	F 180 mm	F 7 1/16"

APPRIA II

INDEX

TECHNICAL CHARACTERISTICS22

1. DESCRIPTION25

1.1 **ACCESSORIES LIST** 26

2. SAFETY PRESCRIPTION 27

3. TRANSPORT AND HANDLING30

3.1 **MACHINE IDENTIFICATION** 30

3.2 **TRANSPORT** 30

3.3 **HANDLING** 30

4. INSTALLATION AND PRELIMINARY OPERATIONS31

5. ADJUSTMENTS TO BE MADE BY A QUALIFIED TECHNICIAN ONLY32

5.1 **PRESSURE SWITCH ADJUSTMENT** 32

5.2 **PUMP ADJUSTMENT** 32

6. USE33

6.1 **SWITCHING THE MACHINE ON/OFF** 33

6.1.1 **APPIA V** 33

6.1.2 **APPIA S** 33

6.2 **SELECTION CONFIGURATION** 33

6.3 **MAKING COFFEE** 34

6.4 **USING STEAM** 34

6.5 **MAKING CAPPUCCINO** 34

6.6 **HOT WATER SELECTION** 35

6.7 **AUTOSTEAM STEAM NOZZLE WITH TEMPERATURE PROBE (OPTIONAL ON V MODEL ONLY)**35

7. PROGRAMMING APPIA V36

7.1 **PROGRAMMING DOSES** 36

7.2 **PROGRAMMING COFFEE DOSES** 36

7.3 **PROGRAMMING HOT WATER** 36

7.4 **PROGRAMMING THE AUTOSTEAM STEAM NOZZLE (OPTIONAL)** 36

7.5 **PROGRAMMING STANDARD DOSES** 36

7.6 **PROGRAMMING OPERATING PARAMETERS** 17

8. CLEANING AND MAINTENANCE38

8.1 **SWITCHING OFF THE MACHINE** 38

8.2 **CLEANING THE OUTSIDE OF THE MACHINE** 38

8.3 **CLEANING STAINLESS COFFEE-HOLDERS** 38

8.4 **CLEANING THE UNIT WITH THE AID OF THE BLIND FILTER** 38

8.5 **CLEANING FILTERS AND FILTER-HOLDERS** 38

8.6 **RESIN AND SOFTENER REGENERATION** 39

9. APPIA V MACHINE FUNCTION MESSAGES40

ELECTRIC SYSTEM APPIA V62

ELECTRIC SYSTEM APPIA S64

PLUMBING SYSTEM66

BOILER DIAGRAM68

APPRIA II

1. DESCRIPTION APPIA II V - S

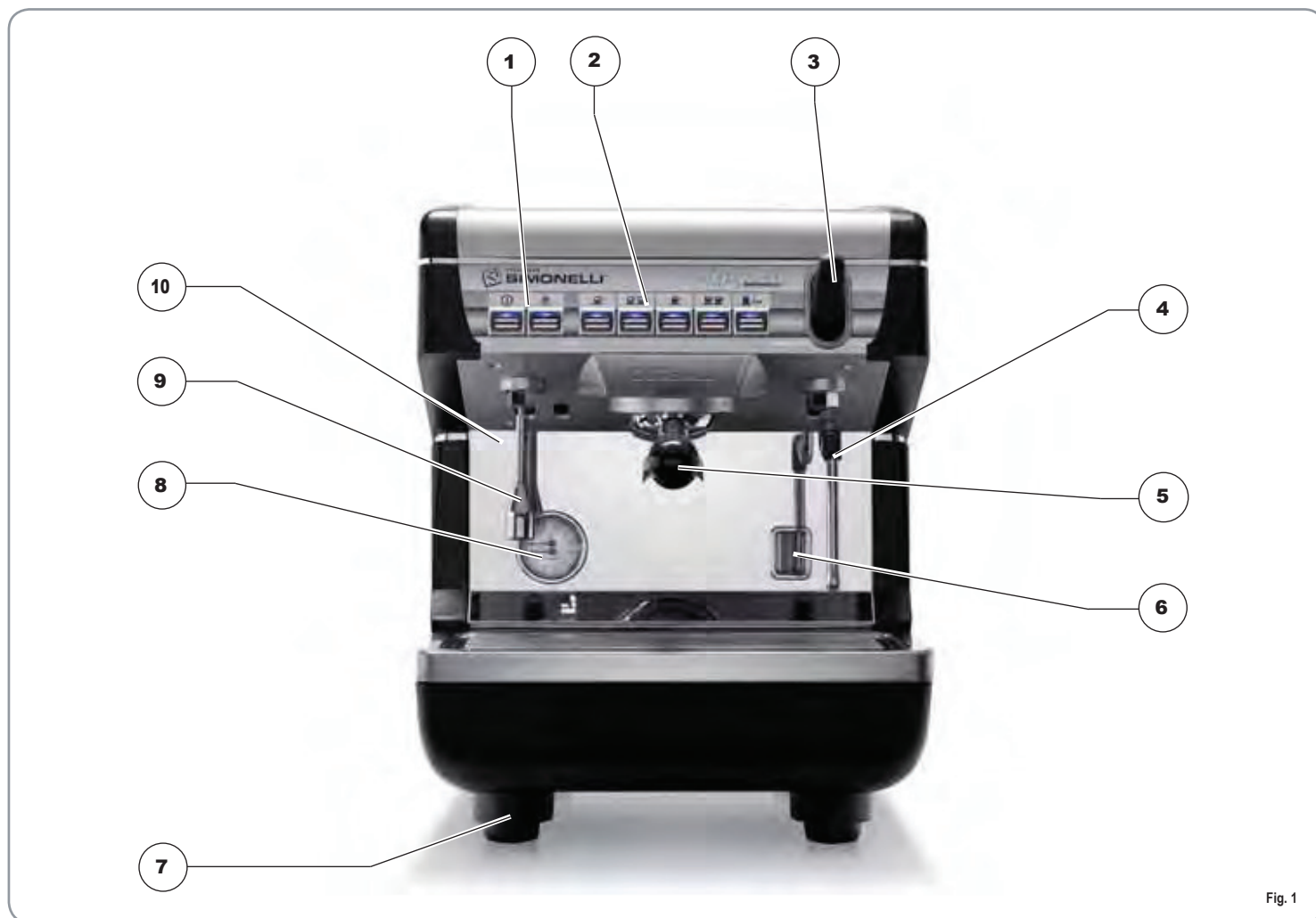

Fig. 1

KEY

- 1 Select buttons
- 2 Delivery buttons
- 3 Steam lever

- 4 Steam nozzle
- 5 Filter holder
- 6 Optical level

- 7 Adjustable foot
- 8 Pressure gauge
- 9 Hot water nozzle
- 10 Rating plate

ENGLISH

1.1 ACCESSORIES LIST

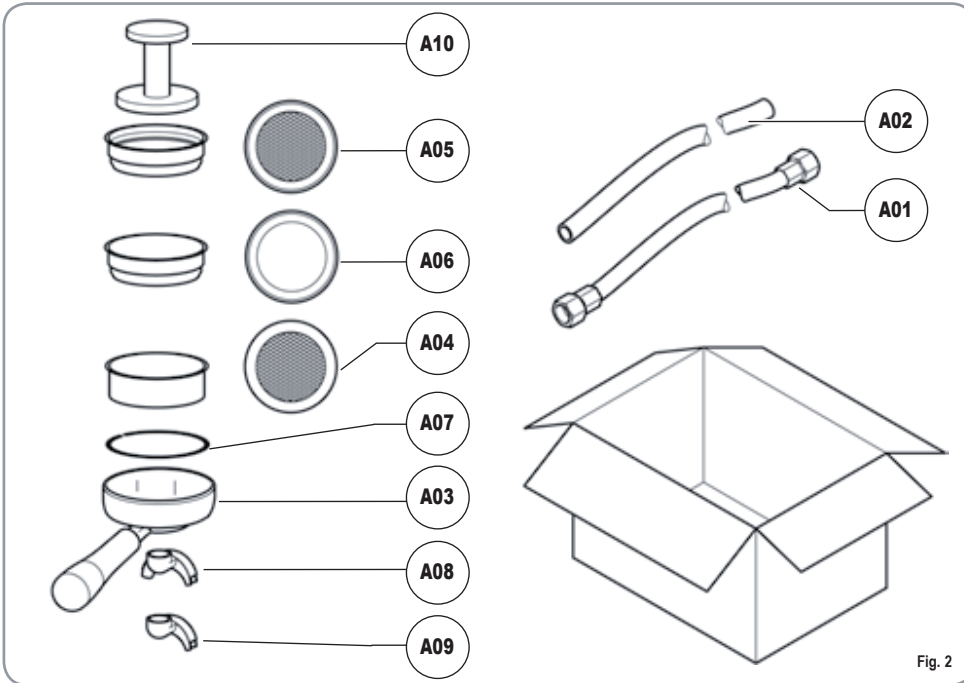





Fig. 2

CODE	DESCRIPTION	QUANTITY
A01	Filling tube 3/4"	1
A02	Waste pipe Ø 25 mm - L. 150 cm + sleeve	1
A03	Filter-holder	2
A04	Double filter	1
A05	Single filter	1
A06	Blind filter	1
A07	Spring	1
A08	Double delivery spout	1
A09	Single delivery spout	1
A10	Coffee presser	1

2. SAFETY PRESCRIPTION

 This book is an integral and essential part of the product and must be given to the user. Read this book carefully. It provides important information concerning safety of installation, use and maintenance. Save it carefully for future reference.

 After unpacking, make sure the appliance is complete. In case of doubts, do not use the appliance, but consult a qualified technician. Packaging items which are potentially dangerous (plastic bags, polystyrene foam, nails, etc..) must be kept out of children's reach and must not be disposed of in the environment.

 **RISK OF POLLUTION**

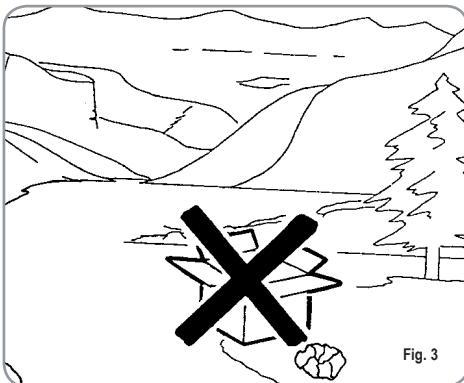



Fig. 3

 The machine is can be installed in staff kitchen areas in shops, offices and other working environments, farm houses by clients in hotels, motels and other residential type environments bed and breakfast type environments.

 Before connecting the appliance make sure the rating plate data correspond with the mains. This plate is on the front panel at the top right hand side of the appliance. The appliance must be installed by qualified technicians in accordance with current standards and manufacturer's instructions.

The manufacturer is not liable for any damage caused due to failure to ground the system. For the electrical safety of the appliance, it is necessary to equip the system with the proper grounding. This must be carried out by a qualified electrician who must ensure that the electric power of the system is sufficient to absorb the maximum power input stated on the plate.

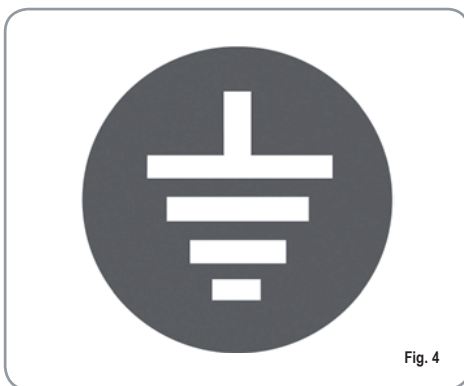







Fig. 4

 In particular you must ensure that the size of the wiring cables is sufficient to absorb power input. The use of adapters, multiple sockets or extensions is strictly forbidden. If they prove necessary, call a fully qualified electrician.

 When installing the device, it is necessary to use the parts and materials supplied with the device itself. Should it be necessary to use other parts, the installation engineer needs to check their suitability for use in contact with water for human consumption.

 The machine must be installed in compliance with the local health standards in force for plumbing systems. Therefore, contact an authorized plumber.

 The device needs to be supplied with water that is suitable for human consumption and compliant with the regulations in force in the place of installation. The installation engineer needs confirmation from the owner/manager of the system that the water complies with the requirements and standards stated above.

 This appliance must only be used as described in this handbook. The manufacturer shall not be liable for any damage caused due to improper, incorrect and unreasonable use.

 This appliance is not suitable for use by children or persons with reduced physical, sensory or mental capabilities, or by persons with a lack of experience or knowledge, unless supervised or given instructions.

At the end of installation, the device is switched on and taken to rated operating conditions, leaving it in a state in which it is “ready for operation”. The device is then switched off and the whole hydraulic circuit is bled of the first lot of water in order to remove any initial impurities. The device is then refilled and taken to rated operating conditions.

reaching the “ready for operation” condition, the following dispensing operations are carried out:

- 100% of the coffee circuit through the coffee dispenser (for more than one dispenser, this is divided equally);
- 100% of the hot water circuit through the water dispenser (for more than one dispenser, this is divided equally);
- opening of each steam outlet for 1 minute.

At the end of installation, it is good practice to draw up a report of the operations.

The maximum and minimum storage temperatures must fall within a range of [-5, +50]°C.

The operating temperature must be within the range of [+5, +35]°C.

Basic rules must be observed when using any electric appliance.

In particular:

- do not touch the appliance when hands or feet are wet;
- do not use the appliance when

CAUTION
RISK OF ELECTRIC SHOCK

barefoot;

- do not use extensions in bath or shower rooms;
- do not pull the supply cord out of the socket to disconnect it from the mains;

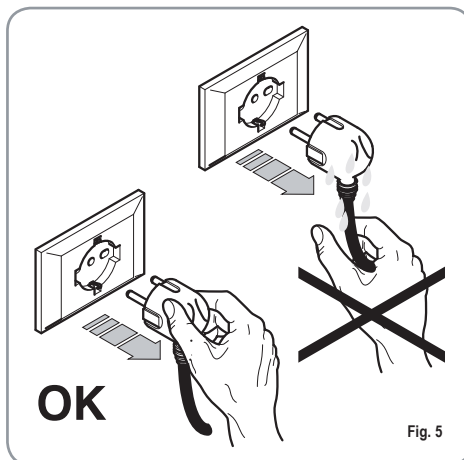

Fig. 5

- do not leave the appliance exposed to atmospheric agents (rain, sun, etc.);
- do not let the appliance be used by children, unauthorised staff or staff who have not read and fully understood the contents of this handbook.

Before servicing the appliance, the authorised technician must first switch off the appliance and remove the plug.

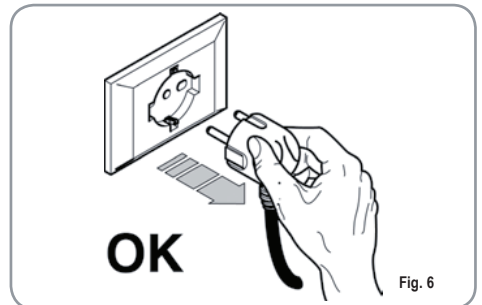

Fig. 6

For all cleaning operations comply exclusively with the instructions given in this booklet.

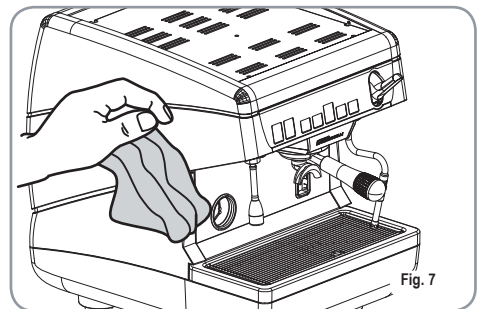





Fig. 7

If the appliance breaks down or fails to work properly, switch it off. Any intervention is strictly forbidden. Contact qualified experts only. Repairs should only be made by the manufacturer or authorized service centres. Only original spare parts must be used. Failure to observe the above, could make the appliance unsafe.

 For installation, the qualified electrician must fit an omnipolar switch in accordance with the safety regulations in force and with 3 (0,12) or more mm (in) between contacts.

 To avoid dangerous overheating, make sure the supply cord is fully uncoiled.

 Do not obstruct the extraction and/or dissipator grids, especially of the cup warmer.

 The user must not replace the appliance supply cord. If the cord is damaged, switch off the appliance and have a qualified technician change the cord.

 If no longer using the appliance, we recommend making it inoperative; after removing the plug from the mains electricity, cut the power supply cable.

 **CAUTION**
RISK OF POLLUTION

 Do not dispose of the machine in the environment: to dispose of the machine, use an authorised centre, or contact the manufacturer for relative information.

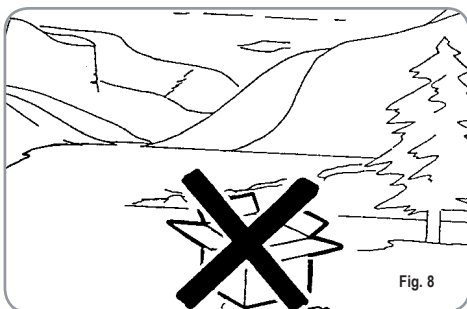

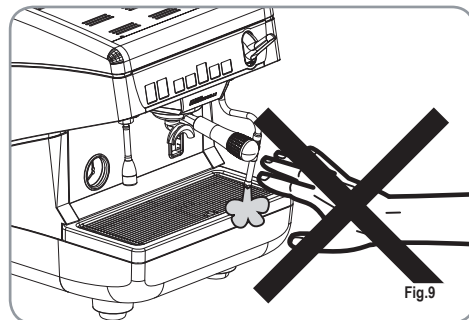

 **CAUTION**
RISK OF INTOXICATION

 Use the steam nozzle with care and never place hands below the jet of steam. Do not touch the nozzle immediately after use.



 **CAUTION**
RISK OF BURNS OR SCALDING

 We remind you that before carrying out any installation, maintenance, unloading or adjustment operations, the qualified operator must put on work gloves and protective footwear.

 The maximum noise disturbance level is lower than 70db.

 If the pipe connecting to the mains water is replaced the old pipe must never be re-used.

 **CAUTION**

 **INFORMATION TO THE USERS**
Under the senses of art. 13 of Law Decree 25th July 2005, n. 151 "Implementation of the Directives/ Guidelines 2002/95/CE, 2002/96/CE and 2003/108/CE, concerning the reduction of the use of dangerous substances in electric and electronic equipment, as well as the disposal of wastes".

The symbol of the crossed large rubbish container that is present on the machine points out that the product at the end of its life cycle must be collected separately from the other wastes. The user for this reason will have to give the equipment that got to its life cycle to the suitable separate waste collection centres of electronic and electrotechnical wastes, or to give it back to the seller or dealer when buying a new equipment of equivalent type, in terms of one to one. The suitable separate waste collection for the following sending of the disused equipment to recycling, the dealing or handling and compatible environment disposal contributes to avoid possible negative effects on the environment and on the people's health and helps the recycling of the materials the machine is composed of. The user's illegal disposal of the product implies the application of administrative fines as stated in Law Decree n.22/1997" (article 50 and followings of the Law Decree n.22/1997).

3. TRANSPORT AND HANDLING

3.1 MACHINE IDENTIFICATION

Always quote the machine serial number in all communications to the manufacturer, Nuova Simonelli.



3.2 TRANSPORT

The machine is transported on pallets which also contain other machines - all boxed and secured to the pallet with supports.

Prior to carrying out any transport or handling operation, the operator must:

- put on work gloves and protective footwear, as well as a set of overalls which must be elasticated at the wrists and ankles.
- The pallet must be transported using a suitable means for lifting (e.g., forklift).

3.3 HANDLING



During all handling operations, the operator must ensure that there are no persons, objects or property in the handling area.

The pallet must be slowly raised to a height of 30 cm (11,8 in) and moved to the loading area. After first ensuring that there are no persons, objects or property, loading operations can be carried out.

Upon arrival at the destination and after ensuring that there are no persons, objects or property in the unloading area, the proper lifting equipment (e.g. forklift) should be used to lower the pallet to the ground and then to move it (at approx. 30 cm (11,8 in) from ground level), to the storage area.



Before carrying out the following operation, the load must be checked to ensure that it is in the correct position and that, when the supports are cut, it will not fall.

The operator, who must first put on work gloves and protective footwear, will proceed to cut the supports and to storing the product. To carry out this operation, the technical characteristics of the product must be consulted in order to know the weight of the machine and to store it accordingly.

4. INSTALLATION AND PRELIMINARY OPERATIONS

After unpacking, assess that the machine and its accessories unit are complete, then proceed as follows:

- place the machine so that it is level on a flat surface;
- assemble its supporting feet by inserting the insert into the cylindrical unit;
- twist the rubber foot into the screw thread inside the unit;
- screw the whole assembled unit into the allotted setting for the machine's adjustable feet;
- level the machine by regulating the adjustable feet;

NOTE: the unit grooves have to face upwards, as shown in the following illustration.

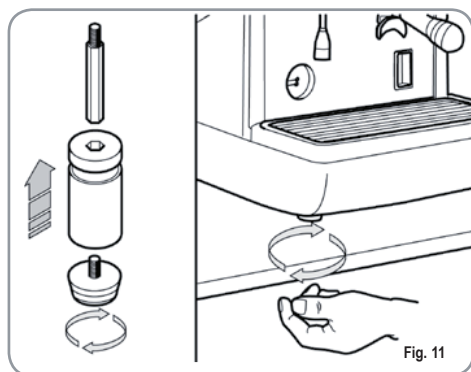

It is advisable to install a softener (1) and then a mesh filter (2) on the external part of the plumbing system, during preliminaries and after levelling the machine.

In this way impurities like sand, particles of calcium, rust etc will not damage the delicate graphite surfaces and durability will be guaranteed.

Following these operations, connect the plumbing systems as illustrated in the following figure.



WARNING

Recommended mains pressure for the water is [2.3] bar.



WARNING

Avoid throttling in the connecting tubes. Assess that the drain pipe (3) is able to eliminate waste.

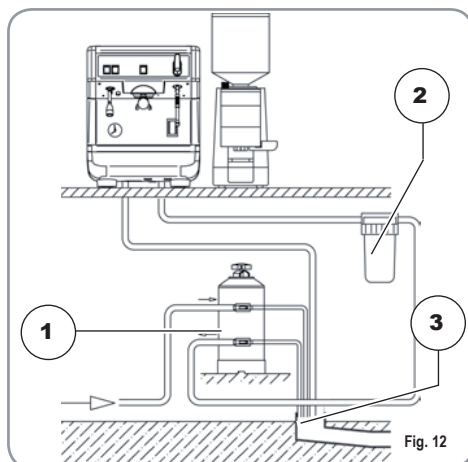

KEY

- 1 Softener
- 2 Mesh filter
- 3 Drain Ø 50 mm

NOTE: For a correct functioning of the machine the water works pressure must not exceed 4 bars.

Otherwise install a pressure reducer upstream of the softener; the internal diameter of water entrance tube must not be less than 6mm ($\frac{3}{8}$ ”).



CAUTION RISK OF SHORT CIRCUITS

The machine must always be protected by an automatic omnipolar switch of suitable power with contact openings of equal distance or more than 3mm.

Nuova Simonelli is not liable for any damage to people or objects due to not observing current security measures.

Prior to connecting the machine to the electrical mains, assess that the voltage shown on the machine's data plate corresponds with that of the mains.

NOTE: At the start of the day's activities and in any case, if there are any pauses of more than 8 hours, then it is necessary to change 100% of the water in the circuits, using the relevant dispensers.

NOTE: In case of use where service is continuous, make the above changes at least once a week.

5. ADJUSTMENTS TO BE MADE BY A QUALIFIED TECHNICIAN ONLY

5.1 PRESSURE SWITCH ADJUSTMENT



CAUTION

The adjustments listed here below must **ONLY** be performed by a Specialist Technical Engineer.

Nuova Simonelli cannot be held liable for any damage to persons or property arising from failure to observe the safety instructions supplied in this manual.



CAUTION
ELECTRIC SHOCK HAZARD

Before performing any operation, the specialist technical engineer must first switch off the main switch off and unplug the machine.

To adjust the service pressure of the boiler, thus regulating the water temperature, according to the various functions and needs of the coffee desired, proceed as follows:

- Remove the cup support grill from the upper part of the machine by removing the central screw "A".

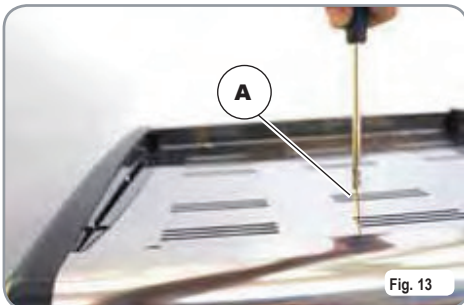

Fig. 13

- Turn the pressure switch adjustment screw to INCREASE (clockwise) or REDUCE (anticlockwise) pressure.



Fig. 14

Advisable pressure: 1 - 1,4 bar
(according to the kind of coffee).

5.2 PUMP ADJUSTMENT

To change the working pressure of the pump and therefore, the coffee extraction pressure, proceed as follows:

- Remove the worktop grid cover;
- Take off the sheet metal guard by unscrewing the two side screws (B) as illustrated in the following figure.

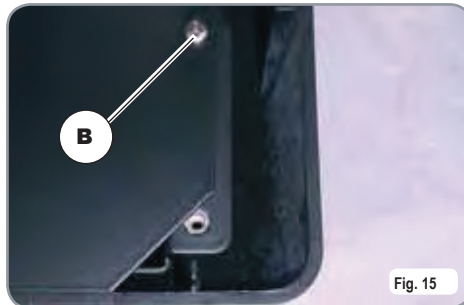

Fig. 15

- Turn the pump registration screw, turning it clockwise to INCREASE and counter clockwise to DECREASE the pressure.

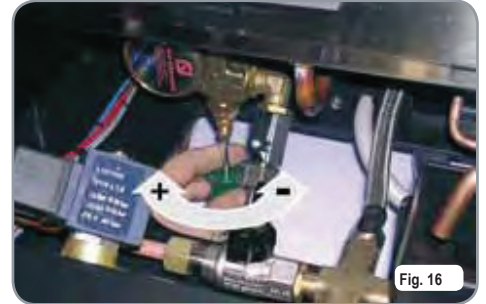

Fig. 16

Advisable pressure: 9 bar.

- The set pump pressure is shown on the lower part of the gauge.



Fig. 17



Once the adjustments have been completed, refit the sheet metal guard into its seating and fix it into place with the two side screws; refit the work surface grille

6. USE

Before starting to use the appliance, the operator must be sure to have read and understood the safety prescriptions contained in this booklet.

6.1 SWITCHING THE MACHINE ON/OFF

6.1.1 APPIA V

- Plug the machine into the mains socket; the LED of the on switch  will begin to flash.
- Hold down the on switch  for 5 seconds.

At this point, the Flash-test will begin; this is where all LEDs are switched on for three seconds, after which the test is complete and the hot water/steam key  will switch off.

The fact that the machine is operating is shown by the LED of the on switch  and all delivery keys, which remain lit.

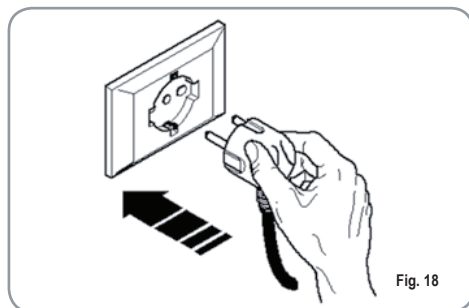

NOTE: once the auto diagnosis has been completed all the keys are activated.



For electronic card maintenance, turn the machine off by means of the external main switch or disconnect the plug.

- To switch off the machine, hold down the on switch  for 5 seconds;

the LEDs on the delivery keys will switch off and the on switch LED will flash.

6.1.2 APPIA S

The machine is fitted with a main switch (A). The fact that the machine is operating is shown by the fact that this switch is set to on. To switch off the machine, move the switch to the off position.



6.2 SELECTION CONFIGURATION

Set the desired function on the available keys placed above the filter-holders (see chapter "DESCRIPTION").

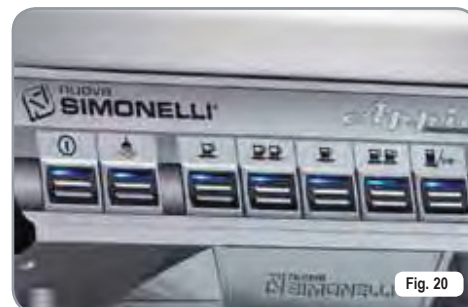

BUTTONS KEY (Selection configuration)



1 small coffee



2 small coffees



1 long coffee



2 long coffees



Continuous

6.3 MAKING COFFEE

Unhitch the filter-holder and fill it with one or two doses of ground coffee depending on the filter used.

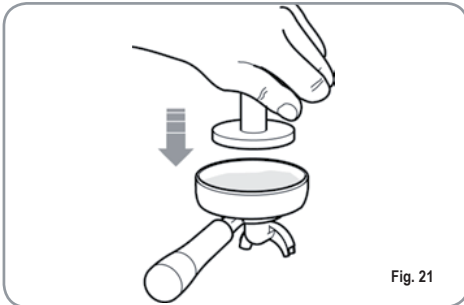

Fig. 21

Press the coffee with the provided coffee presser, dust off any coffee residue from the rim of the filter (this way the rubber gasket will last longer).

Insert the filter in its unit.

Press the desired coffee button:



1 small coffee



2 small coffees



1 long coffee



2 long coffees

By starting up the coffee brewing procedure the unit's pump is activated and the unit's solenoid valve is opened.

By pressing it, the button will turn on and signal the operation

NOTE: when in pause, leave the filter-holder inserted in the unit so that it will keep warm. To guarantee the utmost thermic stability during use, the delivery units are thermo-compensated with complete hot water circulation.

6.4 USING STEAM



CAUTION
RISK OF BURNS OR SCALDING

While using the steam nozzle, you must pay attention to not place your hands beneath it or touch just after it has been used.

To use steam just pull or push the provided lever (Fig. 22).

By pulling it completely the lever will hold a position of maximum delivery; by pushing it, the lever will automatically give way.

The two steam nozzles are articulated to guarantee their easy use.

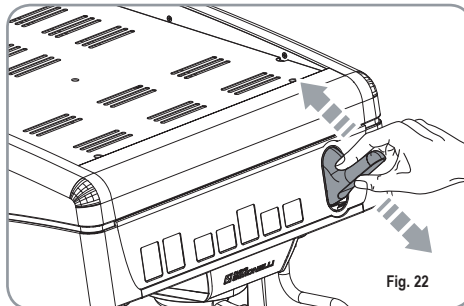

Fig. 22

NOTE: The utilisation of the steam lance must always be preceded by discharging the condensate for at least 2 seconds.

6.5 MAKING CAPPUCCINO

To obtain the typical cappuccino foam, immerse the nozzle all the way into a container 1/3 full of milk (preferably cone-shaped). Turn on the steam. Before the milk starts to boil, pull the nozzle slightly up and lightly move it vertically across the surface of the milk. When you have completed the procedure, clean the nozzle carefully with a soft cloth.

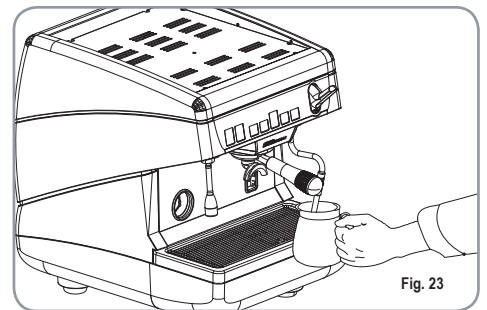
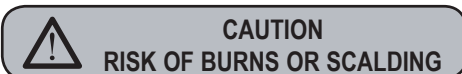



Fig. 23

6.6 HOT WATER SELECTION



While using the hot water nozzle, pay careful attention not to place your hands beneath it or touch it just after it has been used.

This nozzle delivers hot water to make tea or herb teas.

Place a container underneath the hot water nozzle and press the switch (S model) or press the hot water select button  (V model).

Make sure the button lights up.

Water will be delivered from the hot water nozzle for as long as the set time indicates.

NOTE: Hot water can be delivered at the same time as coffee.

6.7 AUTOSTEAM STEAM NOZZLE WITH TEMPERATURE PROBE (OPTIONAL ON V MODEL ONLY)

As an optional extra, the machine can be equipped with an Autosteam steam nozzle in place of the hot water nozzle.

On this version, the hot water nozzle is fitted in place of the manual steam nozzle.

The Autosteam steam nozzle can be used to deliver steam to foam milk or heat other liquids.

Place a suitable container with milk or another beverage inside it beneath the Autosteam steam nozzle.

Press the  key and make sure that the key lights up. The Autosteam steam nozzle will dispense steam until the liquid reaches the pre-set temperature (see chapter 7.4 for programming details).

NOTE: Hot water can be delivered at the same time as coffee.

7. PROGRAMMING Appia V

7.1 PROGRAMMING DOSES

To access the programming units, proceed as follows:

NOTE: the procedure can be carried out with the machine on.

- To enter into the dosing programme press the  dispensing key continuously for 5 seconds.
- The delivery keys will begin to flash.

7.2 PROGRAMMING COFFEE DOSES

To programme the amount of water for each of the delivery keys, proceed as follows:



- fill the filter holder with the right amount of coffee (the double or single filter holder can be used, according to the key to be programmed).
- Place the filter holder in the group.
- Press one of the delivery keys:



- The machine will begin to dispense and once the required quantity has been delivered, press the continued key .



- Delivery will cease and the selected dose key will switch off (the other keys will continue to flash).
- Press the continued key  to exit the programming function or to continue programming other dose keys.

7.3 PROGRAMMING HOT WATER

- Use the relevant procedure to enter the programming function.
- Press the hot water selection key .
- Hot water delivery will begin.
- Decide the required amount of hot water and then press the key  again.

- Press the continued key  to exit the programming function or to continue programming other selection keys.

7.4 PROGRAMMING THE AUTOSTEAM STEAM NOZZLE (OPTIONAL)

- Use the relevant procedure to enter the programming function.
- Insert a jug containing milk and press the steam key ; this will make steam come out of the nozzle.
- When the steam key  is pressed again, the control unit will store the sample temperature reached in its memory (if the milk tem-

perature reaches the maximum temperature, steam delivery will be stopped and the maximum value will remain the setting for the control unit).

- Press the continued key  to exit the programming function or to continue programming other selection keys.

7.5 PROGRAMMING STANDARD DOSES

- It is possible to enter pre-set values for the 4 group doses and water (steam).

To do this, it is necessary to press the key  and hold it down for at least 10 seconds until the flashing keys switch off.

The doses are:

1CN	2CN	1CL	2CL
40 cc	60 cc	50 cc	85 cc

WATER	STEAM TEMP
0 sec.	50° C

NOTE: A time setting of 0 seconds for steam and water means this function will work continually.

IMPIANTO ELETTRICO / ELECTRIC SYSTEM / INSTALLATION ÉLECTRIQUE

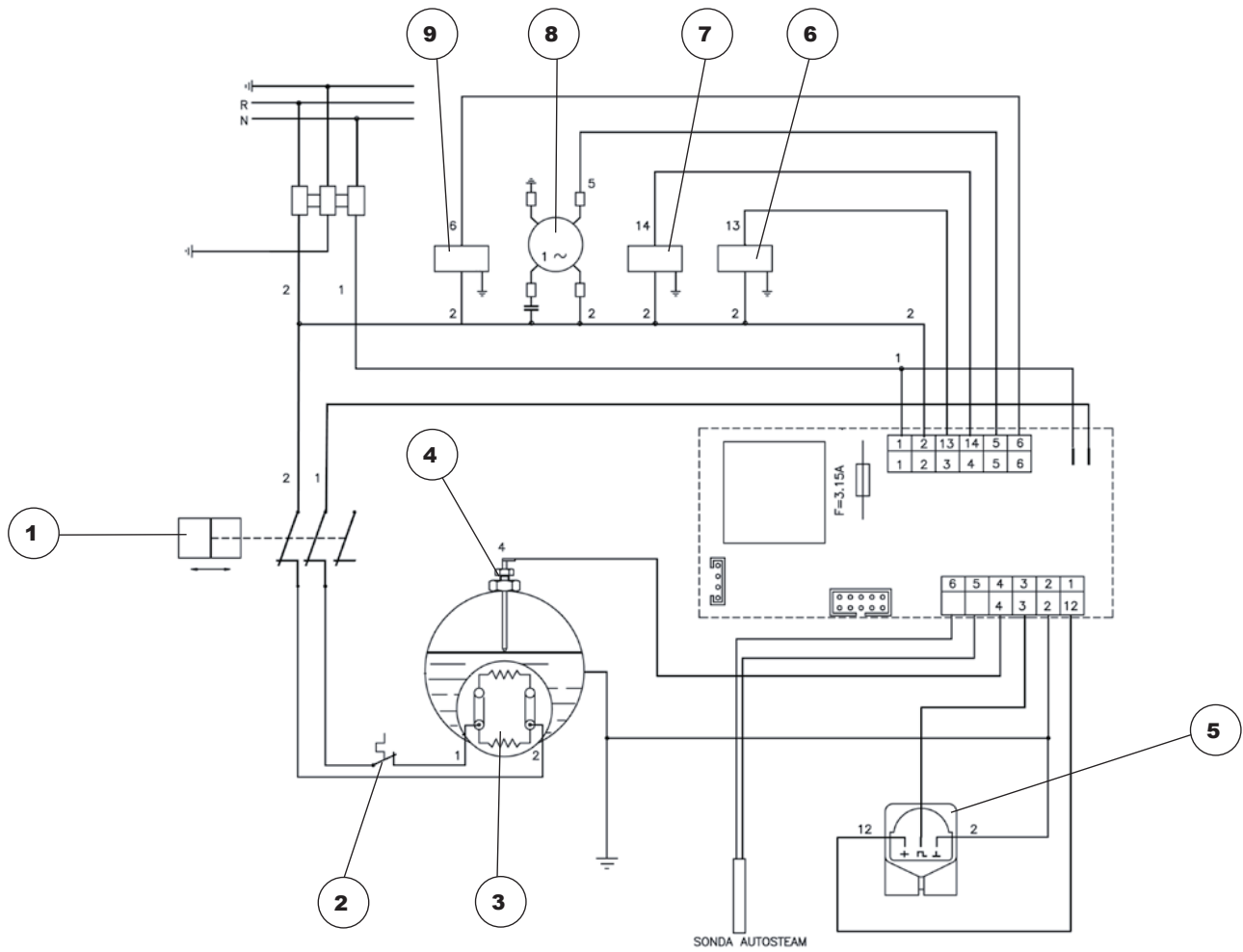

Fig. 31

IMPIANTO ELETTRICO /ELECTRIC SYSTEM / INSTALLATION ÉLECTRIQUE

LEGENDA

- 1 Pressostato
- 2 Termostato sicurezza
- 3 Resistenza
- 4 Sonda livello
- 5 Ventolino gruppo
- 6 Elettrovalvola livello
- 7 Elettrovalvola erogazione gruppo
- 8 Motore pompa
- 9 Elettrovalvola vapore / acqua calda

LEGEND

- 1 Pressure switch
- 2 Safety thermostat
- 3 Heating element
- 4 Level probe
- 5 Fan group
- 6 Level solenoid valve
- 7 Group delivery solenoid valve
- 8 Pump motor
- 9 Steam / hot water solenoid valve

LÉGENDE

- 1 Pressostat
- 2 Thermostat de sécurité
- 3 Résistance
- 4 Sonde niveau
- 5 Ventilateur groupe
- 6 Électrovanne de niveau
- 7 Électrovanne de distribution groupe
- 8 Moteur pompe
- 9 Électrovanne vapeur / eau chaude

IMPIANTO ELETTRICO / ELECTRIC SYSTEM / INSTALLATION ÉLECTRIQUE

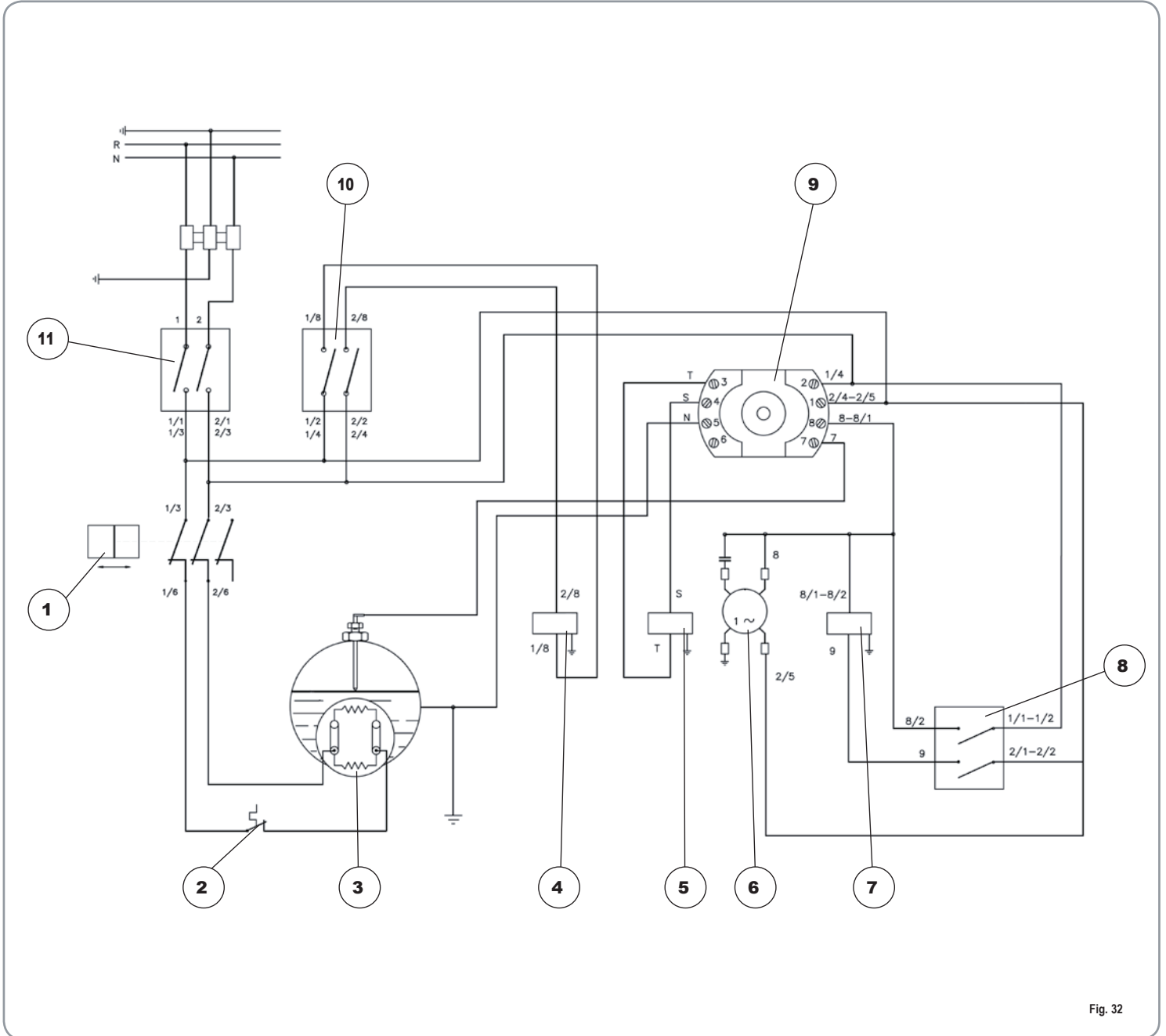

Fig. 32

IMPIANTO ELETTRICO /ELECTRIC SYSTEM / INSTALLATION ÉLECTRIQUE

LEGENDA

- 1 Pressostato
- 2 Termostato sicurezza
- 3 Resistenza
- 4 Elettrovalvola vapore / acqua calda
- 5 Elettrovalvola livello
- 6 Motore pompa
- 7 Elettrovalvola erogazione gruppo
- 8 Interruttore erogazione
- 9 Centralina
- 10 Interruttore acqua calda / vapore
- 11 Interruttore generale

LEGEND

- 1 Pressure switch
- 2 Safety thermostat
- 3 Heating element
- 4 Steam / hot water solenoid valve
- 5 Level solenoid valve
- 6 Pump motor
- 7 Group delivery solenoid valve
- 8 Delivery switch
- 9 Control unit
- 10 Hot water / steam switch
- 11 Main switch

LÉGENDE

- 1 Pressostat
- 2 Thermostat de sécurité
- 3 Résistance
- 4 Électrovanne vapeur / eau chaude
- 5 Électrovanne de niveau
- 6 Moteur pompe
- 7 Électrovanne de distribution groupe
- 8 Interrupteur distribution
- 9 Centrale
- 10 Interrupteur eau chaude / vapeur
- 11 Interrupteur général

**IMPIANTO IDRAULICO / PLUMBING SYSTEM / INSTALLATION
HYDRAULIQUE**

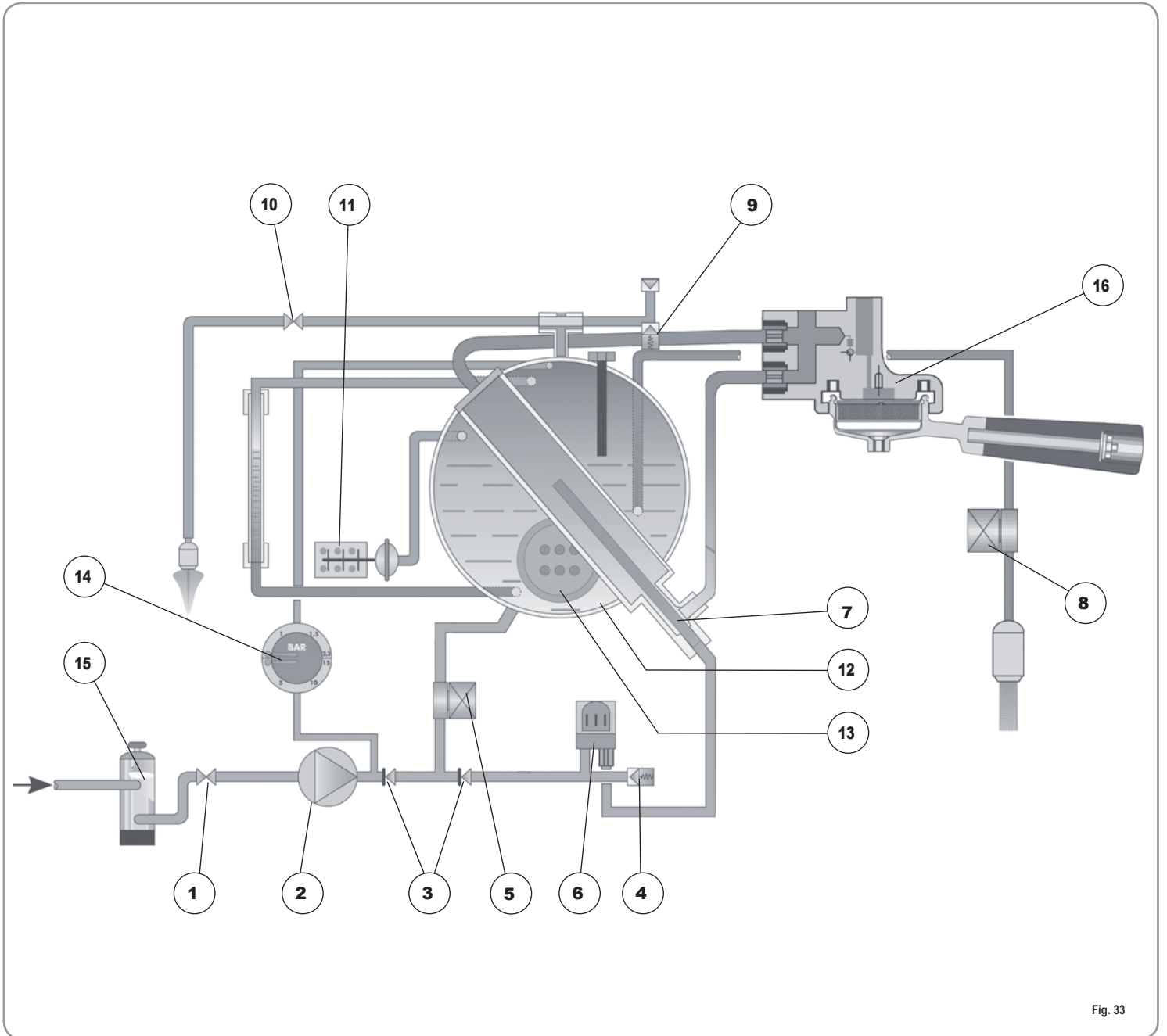

Fig. 33

IMPIANTO IDRAULICO / PLUMBING SYSTEM / INSTALLATION HYDRAULIQUE

LEGENDA

- 1 Rubinetto ingresso acqua
- 2 Pompa
- 3 Valvola di ritegno
- 4 Valvola di espansione
- 5 Elettrovalvola di livello
- 6 Dosatore volumetrico
- 7 Scambiatore di calore
- 8 Elettrovalvola erogazione
- 9 Valvola di sicurezza cald.
- 10 Rubinetto vapore
- 11 Pressostato
- 12 Caldaia
- 13 Resistenza
- 14 Manometro doppia scala
- 15 Depuratore
- 16 Gruppo erogatore

LEGEND

- 1 Water inlet valve
- 2 Pump
- 3 Check valve
- 4 Expansion valve
- 5 Level solenoid valve
- 6 Volumetric doser
- 7 Heat exchanger
- 8 Delivery solenoid valve
- 9 Boiler tank safety valve
- 10 Steam valve
- 11 Pressure switch
- 12 Boiler tank
- 13 Heating element
- 14 Pressure gauge with dual scale
- 15 Water softener
- 16 Delivery group

LÉGENDE

- 1 Robinet arrivée d'eau
- 2 Pompe
- 3 Soupape d'arrêt
- 4 Soupape d'expansion
- 5 Électrovanne de niveau
- 6 Doseur volumétrique
- 7 Échangeur de chaleur
- 8 Électrovanne de distribution
- 9 Soupape de sûreté chaudière
- 10 Robinet vapeur
- 11 Pressostat
- 12 Chaudière
- 13 Résistance
- 14 Manomètre double échelle
- 15 Dépurateur
- 16 Groupe de distribution

SCHEMA CALDAIA / BOILER DIAGRAM / SCHÉMA DE CHAUDIÈRE

DATI PROGETTO DIRETTIVA PED 97/23/CE
PROJECT DATA FOR DIRECTIVE PED 97/23 CE
DONNEES PROJECT DIRECTIVE PED 97/23 CE

VOLUME	4,4 LT
TS	130.5° C
P.V.S.	1.8 Bar
PT	2.7 Bar
FLUIDO FLUID FLUIDE	H2O

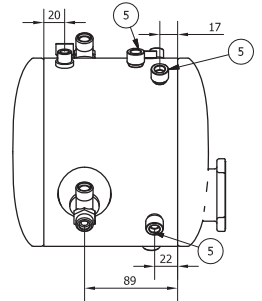
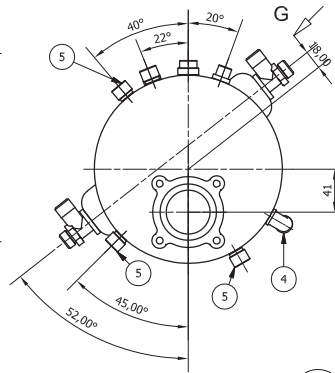
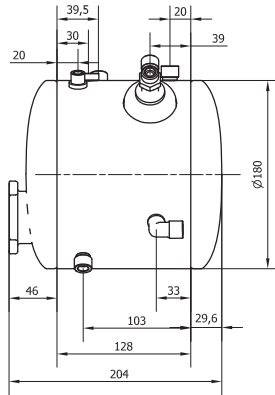

Elenco parti **List of Parts** **Liste des composants**

ELEMENTO ELEMENT ELEMENT	QTA QTY QTE	NUMERO PARTE PART.NO NUM.COMPOSANT	DESCRIZIONE DESCRIPTION DESCRIPTION	MATERIALE MATERIAL MATERIAU
1	1	00015120	Viola caldaia D.180 1Gr SP 1.2 Viola boiler D.180 1Gr SP 1.2 Virole chaudière D.180 1Gr SP 1.2	CU DHP 99.9
2	1	00010121	Fondo Bombato caldaia D.180 SP 1.5 Curved bottom of the boiler D.180 SP 1.5 Fond Bombé chaudière D.180 ép. 1.5	CU DHP 99.9
3	2	00061462	Raccordo T scambiatore Appia Mod. Exchanger fitting T Appia Mod. Raccord en T échangeur Appia Mod.	CU DHP 99.9
4	1	00061551	Gomito a saldare 3/8 M Elbow for welding 3/8 M Coude à souder 3/8 M	OT57 CW510L
5	5	00030251	Attacco G 3/8" Maschio Coupling G3/8" Male Prise 3/8 " Mâle	OT57 CW510L
6	1	00015090	Coppa D.180 PR 2013 Bevel gear D.180 PR 2013 Coupe D.180 PR 2013	OT57 CW510L
7	1	00063130	Flangia Resistenza 4 fori 2013 Heater El. Flange 4 holes 2013 Flasque Resistance 4 trous	OT57 CW510L
8	1	00160390	Tubo scambiatore Appia 1GR Appia 1GR heat exchanger tube Tube échangeur Appia 1GR	CU DHP 99.9
9	1	00030271	Attacco G1/4" F passante Coupling G1/4" F bypass Prise G1/4" F pontage	OT57 CW510L
10	2	00030631	Attacco 1/4" Maschio Coupling 1/4" Male Prise 1/4 Mâle	OT57 CW510L

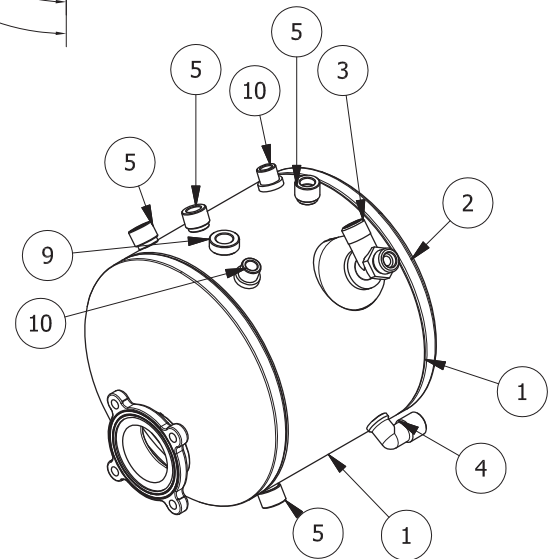

Materiale Material Materiau	Trattamento Treatment Traitement	Tolleranza Tolerance Tolérance	Scala Scale Echelle	A2
Rame, Ottone Copper, Brass Cuivre, Laiton	Decapaggio Pickling Décapage		1:4	
Descrizione Description Description			Data	
Caldaia Boiler Chaudiere 1 Gr Appia D.180 2 coppe			15/05/201	3
Descrizione Description Description			Codice	
Nuova Simonelli			M.F.	90014760

Fig. 34

