

Item / Assembly	Part #	Description	Qty.
1	2774063	i-PILOT CONTROLLER 1.6 PWRDRV	1
	2774054	i-PILOT CONTROLLER 1.6 RT PD	1
2	2994075	REMOTE ASY, iPILOT 1.6	1
3	22224704	INSERT-PLUG, BLK, I PILOT	1
4	2375403	HEATSHRK .375X2 ADH LINED	10
5	2390800	LANYARD w/CARABINEER, IP REMOTE	1
■	2397101	MANUAL, QUICK REF, iPILOT 1.6 (not shown)	1

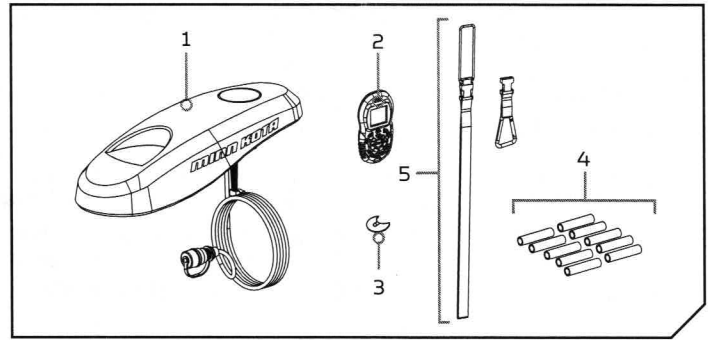

### TOOLS AND RESOURCES REQUIRED

- #2 Phillips Screwdriver
- Heat gun
- 30-45 Minutes



## CAUTION

Always wear safety glasses and gloves. Disconnect all power to the trolling motor before beginning any work or maintenance. Johnson Outdoors Inc. is not responsible for any damage due to improper rigging or installation. If you do not have the skills, experience and tools to perform the following maintenance and repairs, we recommend you seek the help of a Minn Kota Authorized Service Center. A list of Authorized Service Centers can be found at <http://www.minnkotamotors.com/Authorized-Service-Providers/>. Or contact our Technical Service Department by email at [service@minnkotamotors.com](mailto:service@minnkotamotors.com) or, by dialing 800-227-6433.

**NOTE:** These instructions cover accessory installation only. To download the complete owner's manual visit <https://www.minnkotamotors.com/Accessories.aspx>. Scan the QR code to view Minn Kota Accessories Owner's Manuals Online



### REMOVAL

- Use the #2 Phillips Screwdriver to remove the 4 screws that secure the control box cover and remove the control box cover
- If AutoPilot was installed remove all six (6) wires connected to the AutoPilot Board, then remove the Autopilot Board. Cover the exposed end of each wire with one of the included heat shrinks and then use the heat gun to seal the heat shrink onto the connector end.
- Remove the Insert Plug. Push from the inside, down on the edge closest to the coil cord, the plug will "pop" out.
- Use the #2 Screwdriver to remove both sideplates, then remove the Center Cover exposing the main control board. If CoPilot is installed disconnect its plug connection from the main control board.

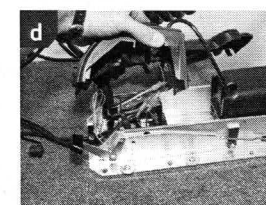
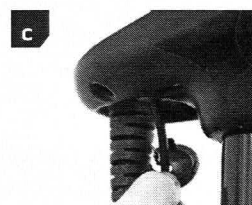
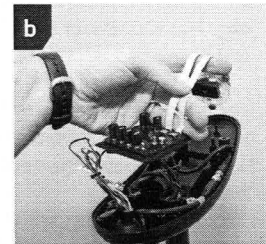

## INSTALLATION

- Route the i-Pilot Controller Cable that is attached to the i-Pilot Controller down through the opening that the Insert Plug was removed from.
- Continue feeding the i-Pilot Controller Cable down the interior of the coil cord.
- Install the Insert plug that was included with this kit. Position the Tab that is opposite the opening in the Insert Plug in the Slot closest to the the Motor Shaft, guide the US2 Cable, if installed, and the Ethernet cable into the opening in the Insert Plug then push up on the Insert Plug until the other two tabs snap into place.
- If AutoPilot was removed position the wires at the base of the control box next to the Insert Plug. Verify the Motor Wires and US2 cable (if equipped) are routed as low as possible in the control box and do not cross any of the raised ribs.
- Place the i-Pilot Controller on the control box, use the #2 Phillips Screwdriver to install the four screws that secure the Controller/ Control Box Cover.
- Use the #2 Phillips Screwdriver to remove the Strain Relief that holds the foot Pedal cable and power lead near the control board.
- If CoPilot was installed complete the removal by using the #2 Phillips screwdriver to remove the two screws retaining the CoPilot Control Board in the Sideplate.
- Place the Power Leadwire in the large cavity in the strain relief, the plug connection from the Control Board in the smaller cavity closest to the hole the screw passes through, and the small lead with the black and wires in the final cavity in the strain relief. Install the screw that retains the Strain Relief.
- Locate the Black and White Wires going to the steering housing. On Riptide Motors cut the heatshrinks off of these connections. Separate the Bullet Terminals.
- Slide two of the included heat shrinks onto the wire leads coming from the steering motor.
- Connect the Bullet Terminals from the Small Controller Lead to the Terminals coming from the Steering Housing, the wires should be Black to Black, White to White and the Terminals should Match. Position the heat shrinks that were installed in step J so they cover the connection and then use the heat gun to seal them.
- Place two of the included heat shrinks on the exposed white and black leads that were connected to the leads from the Steering Housing then use the heat gun to seal those connections.
- Reinstall the Center Cover and Sideplates. Complete the Installation by connecting the Plug Connection from the Control Board to the Plug Connection from i-Pilot Controller.

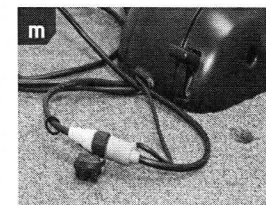
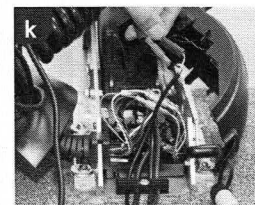
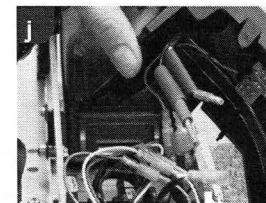
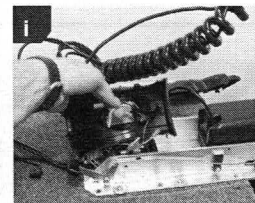
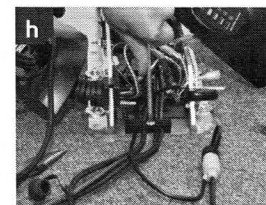
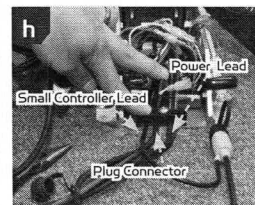
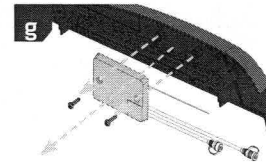
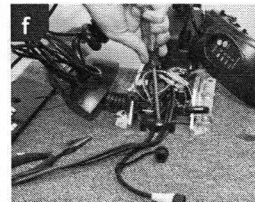
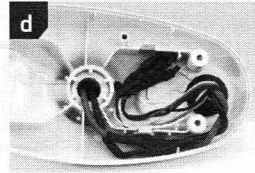
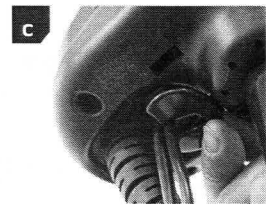
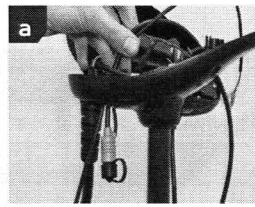

### Pairing Remote to iPilot Controller Head

- Turn on remote, press OK
- Press down arrow once and press system
- Scroll Down to Pair and click Pair
- While remote says "Scanning For Motor" press and hold the pair button on the iPilot head controller until it beeps three times.
- Remote is now paired

For warranty information please visit [minnkotamotors.com](http://minnkotamotors.com)



[minnkotamotors.com](http://minnkotamotors.com)

Minn Kota Consumer & Technical Service  
Johnson Outdoors Marine Electronics, Inc.  
PO Box 8129  
Mankato, MN 56001

121 Power Drive  
Mankato, MN 56001  
Phone (800) 227-6433  
Fax (800) 527-4464



©2018 Johnson Outdoors Marine Electronics, Inc.  
All rights reserved.