



**DOWNLOAD COLOR  
INSTALL MANUALS AT  
*dieselperformance.com***



# 2007.5-18 Dodge 6.7L Cummins Remote Mount BD Exhaust Brake

(Uses factory exhaust brake switch & ECU control)

<b>1027342</b>	<b>2007.5-12</b>	<b>4" Exhaust</b>
<b>1027343</b>	<b>2013-18</b>	<b>4" Exhaust</b>

Serial # \_\_\_\_\_

Date Purchased \_\_\_\_\_

Purchased from \_\_\_\_\_

Installed by \_\_\_\_\_

**\*\*\* Please read this manual before starting installation. \*\*\***

**OWNER'S MANUAL - LEAVE IN GLOVE BOX**

**The brake pressure at idle must be checked and adjusted at time of install, at least two weeks after install, and at regular twice a year intervals.**

# Table of Contents

**Introduction ..... 3**

**Tuning Requirements ..... 4**

**Other Compatibility Requirements ..... 4**

**Kit Contents ..... 5**

**Tools Required..... 6**

**Accessories ..... 6**

**Installation..... 6**

    Brake Valve Installation ..... 7

    Air Hose Installation ..... 10

    Air Compressor Mounting Installation ..... 11

    Regulator Installation..... 14

    Regulator Plumbing..... 15

    Electrical Connections..... 17

**Wiring & Plumbing Diagram ..... 19**

**Exhaust Back Pressure Testing for Air Actuated Brakes ..... 20**

    Idle Pressure Test..... 21

    Off-Idle Pressure Test & Adjustment ..... 22

**Maintenance..... 23**

**Operating Guidelines ..... 23**

**Troubleshooting ..... 25**

## ***Introduction***

Thank you for purchasing a BD Exhaust Brake.

This exhaust brake kit allows you to keep the exhaust braking feature after the stock VGT turbocharger has been removed. The brake is controlled by ECM just like the stock VGT turbocharger meaning it is controlled by the switch already in your dash. Your new BD exhaust brake keeps all of the features of the original brake including the cold weather warmup feature, cruise control compatibility and the brake release on downshifts to reduce transmission wear. The control module comes with a wiring harness that plugs in where the stock turbocharger connected, this means there is no splicing into stock wiring, no wiring through the firewall and a much cleaner installation.

This exhaust brake has been designed to be used on vehicles with aftermarket upgraded turbochargers such as BDs single and twin turbo kits. It requires the vehicle have engine tuning to account for the turbocharger replacement and cannot be used in conjunction with the stock VGT turbocharger. Additionally, this brake is not compatible with exhaust filter systems (DPF).

To use this kit your vehicle must have been equipped with the factory exhaust brake button on the dash or must have been upgraded to have this feature. If your vehicle was not equipped with a factory exhaust brake, see BD kit 1027340.

This manual is divided into different areas to assist you with the installation and operation of your braking unit. We strongly suggest that you write down the kit and serial numbers of your unit in the spaces provided and retain this manual for future reference.

BD Engine Brake Inc.

Plant Address: 33541 MacLure Rd. Abbotsford, BC, Canada V2S 7W2

U.S. Shipping Address: 88-446 Harrison St, Sumas, WA 98295 U.S. Mailing Address: P.O. Box 231, Sumas, WA 98295

Phone: 604-853-6096 | Fax: 604-853-8749 | Internet: [www.bd-power.com](http://www.bd-power.com)

## Tuning Requirements

It is important that the engine tuning not fully disable ECM VGT control for this exhaust brake kit to work. This kit relies on the VGT turbo data link to determine when the exhaust brake turns on and off.

BD Diesel has tested this kit with H&S, Bully Dog and Smarty box tuners. EFI Live and other custom tuning must not disable the VGT operation. See information below.

The following is an example from a 2009 truck, others will be similar.

EFI Live: F1030 VGT Module Fitted must be set to YES, E8756 Turbo Speed Sensor Fitted must be set to YES. All relevant P-trouble codes must be disabled.

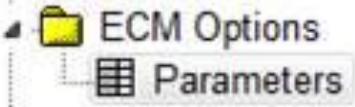
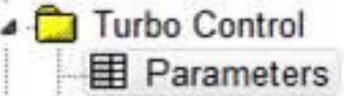
	{E0515} Cruise Control Speed Limit	100
	{F1030} VGT Module Fitted	Yes
	{F1221} ECM Controlled Electric Fans	Yes
	Description	Value
	{E8756} Turbo Speed Sensor Fitted	Yes

## Other Compatibility Requirements

All years of trucks require the exhaust backpressure (EBP) sensor be plugged in or the ECM will disable the exhaust brake. The EBP sensor does not need to be connected to the manifold, only plugged into the electrical connector. 2013-2017 trucks often have the EBP sensor removed from the truck however this sensor needs to be plugged in and tied out of the way for this kit to function. This is not normally an issue on 2007-2012 trucks as the sensor is mounted on the thermostat housing and is normally left in that spot and not removed from the vehicle.



BD Engine Brake Inc.

Plant Address: 33541 MacLure Rd. Abbotsford, BC, Canada V2S 7W2

U.S. Shipping Address: 88-446 Harrison St, Sumas, WA 98295 U.S. Mailing Address: P.O. Box 231, Sumas, WA 98295

Phone: 604-853-6096 | Fax: 604-853-8749 | Internet: www.bd-power.com

# Kit Contents

Confirm you have all the parts listed in this kit before starting the disassembly of your vehicle.

<b>1127038-A</b>		<b>1030129-D</b>		<b>1220113-A</b>	
					
<b>Valve Assembly</b>		<b>Compressor Assembly</b>		<b>Air Tubing Assembly</b>	
<b>Qty: 1</b>		<b>Qty: 1</b>		<b>Qty: 1</b>	
<b>1100400</b>		<b>1100404</b>		<b>1100740</b>	
					
<b>4" Pipe Adapter</b>		<b>4" Marmon Clamp</b>		<b>4" S/S Exhaust Clamp</b>	
<b>Qty: 2</b>		<b>Qty: 2</b>		<b>Qty: 1</b>	
				<b>1300131</b>	
					
				<b>6" Tie Wraps</b>	
				<b>Qty: 12</b>	
<b>1304562</b>			<b>1220139-A</b>		
					
<b>Brake Control Module</b>			<b>Regulator/Control Assy.</b>		
<b>Qty: 1</b>			<b>Qty: 1</b>		

<b>Kit 1027342 Only</b>
<b>1304565</b>
<b>Harness VGT to Module 07-12 (Gray plug)</b>
<b>Qty: 1</b>

<b>Kit 1027343 Only</b>
<b>1304566</b>
<b>Harness VGT to Module 13-18 (Black plug)</b>
<b>Qty: 1</b>

**Tools Required**

- Measuring tape or ruler
- Reciprocating saw or hacksaw
- Wire Crimping Pliers
- Socket Set
- Welder
- Heat gun or lighter

**Accessories**

Description	Part #
Brake Pressure Testing Gauge Kit	<b>1030050</b>
Transmission Temperature Gauge (Auto Transmission)	<b>1030583</b>
Exhaust Temperature Gauge (Pyrometer)	<b>1030514-I</b>
Cool Down Timer (Turbo Timer)	2006-2009 <b>1081160-D1</b>
	2010-2012 <b>1081160-D2</b>
	2013-2018 <b>1081160-D3</b>

**Installation**

To prevent damage to electronic components, it is recommended that both battery negative terminals be disconnected while working on the vehicle.

**Please read this manual thoroughly before installing this exhaust brake.**



## Brake Valve Installation



Raise and support the vehicle with a vehicle hoist or with appropriate jack stands.

Ensure vehicle is safely supported before proceeding to reduce possibility of damage or injury.

Beneath the vehicle, locate the exhaust downpipe and front exhaust pipe beside the transmission.

Choose a section of pipe that is as straight as possible. Mock up the brake valve in this area to ensure it will fit before cutting the pipe. Mark a 7-1/4" section for removal.

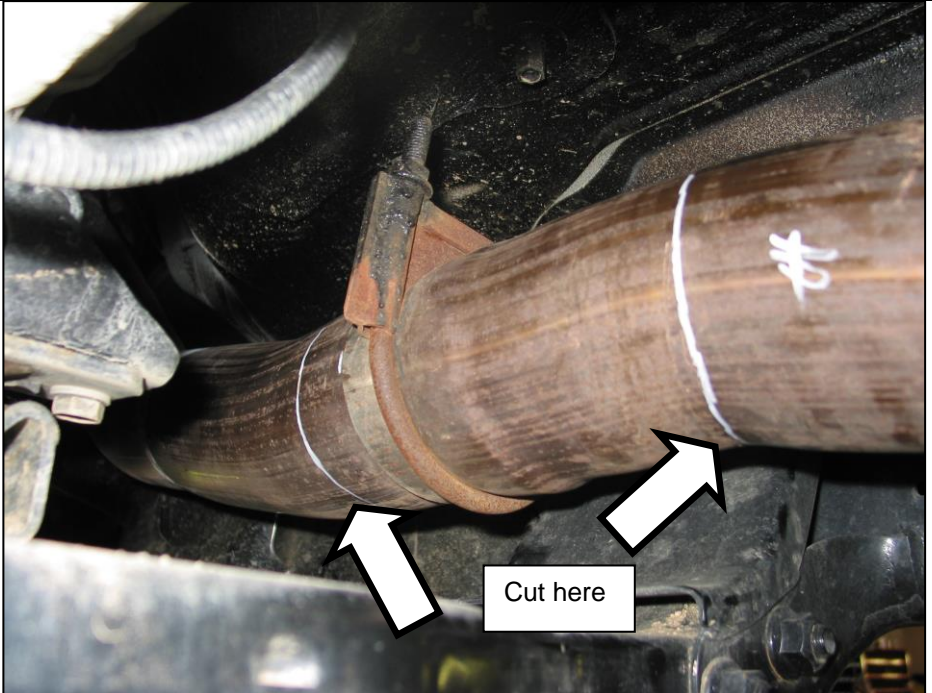

Cut out the marked pipe section using a reciprocating saw or cutting disk. Remove any burrs left on the edge of the pipe using a file or similar tool, then slide the pipe adapters onto the two cut ends of the pipe.



BD Engine Brake Inc.

Plant Address: 33541 MacLure Rd. Abbotsford, BC, Canada V2S 7W2

U.S. Shipping Address: 88-446 Harrison St, Sumas, WA 98295 U.S. Mailing Address: P.O. Box 231, Sumas, WA 98295

Phone: 604-853-6096 | Fax: 604-853-8749 | Internet: [www.bd-power.com](http://www.bd-power.com)

Install the brake valve between the two exhaust pipe adapters using the two supplied V-band clamps. Ensure the exhaust pipe adapters are in line with the brake valve to prevent possible leakage.

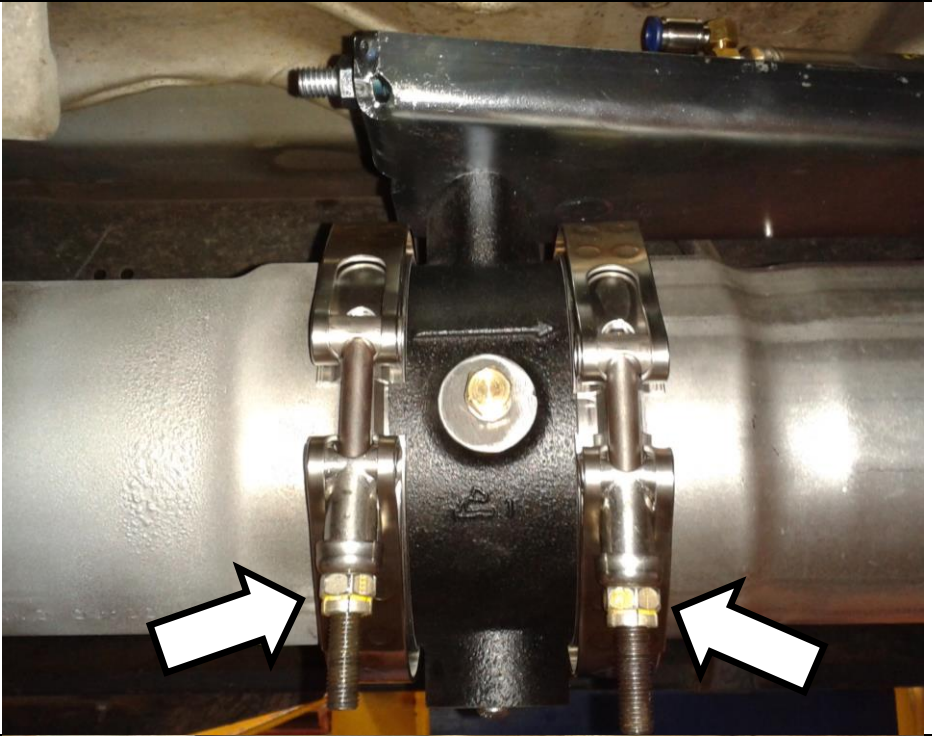

Weld the front adapter to the exhaust pipe. This weld must completely seal the exhaust system as it must retain pressure.

**Note** It is recommended that the weld be spray painted to slow down corrosion along the weld bead.

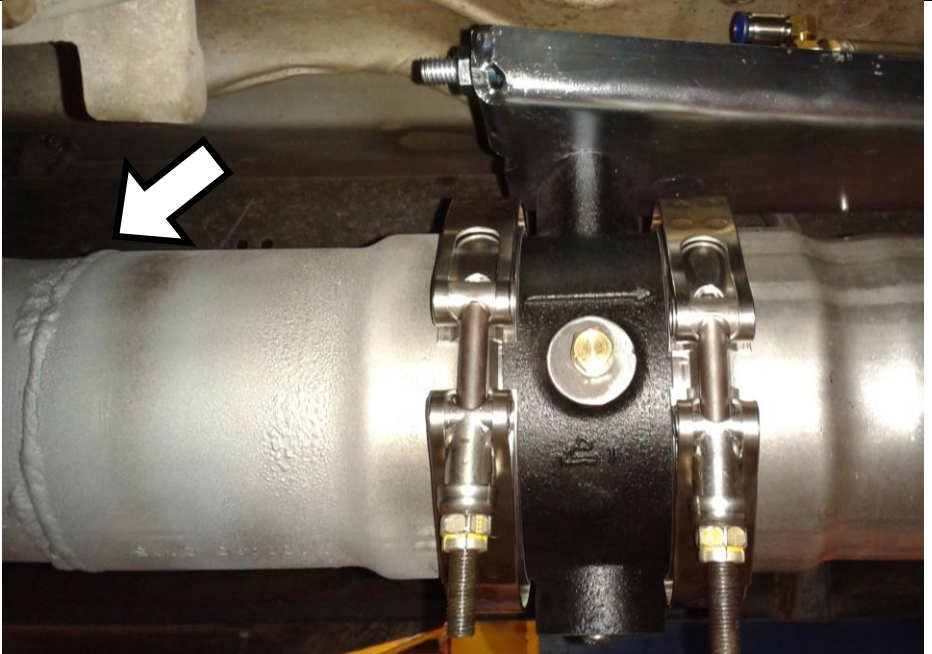

**IMPORTANT** The front exhaust connection **MUST** be welded. Using a band clamp or conventional exhaust clamp on this joint will cause leaks and will not retain full exhaust brake pressures.



Install the supplied stainless steel band clamp on the rear exhaust pipe adapter. Tighten bolts until the band fully conforms to both pipes creating a seal.

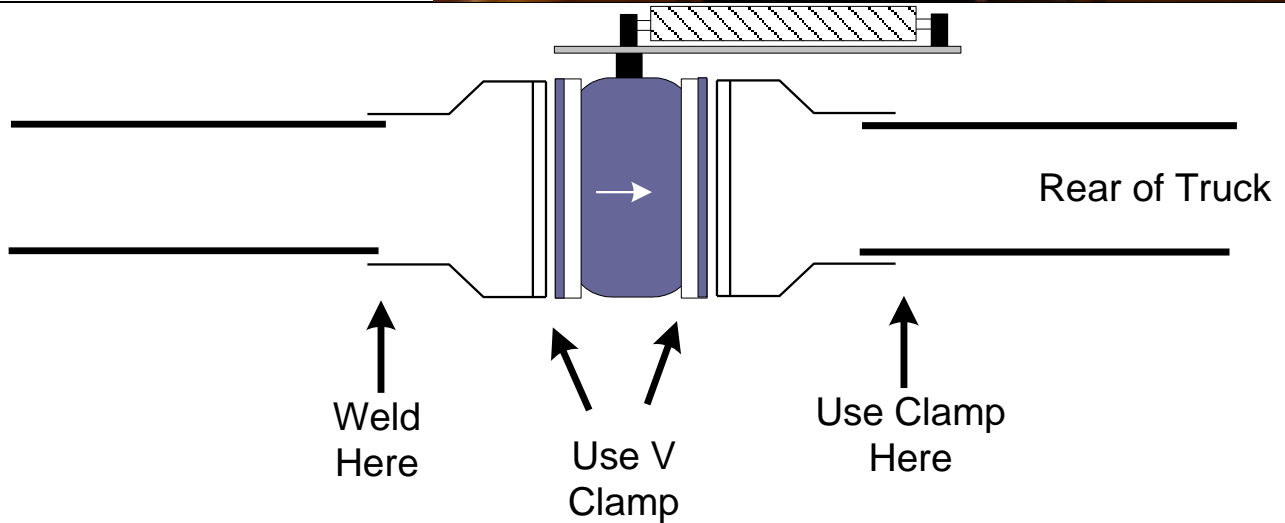
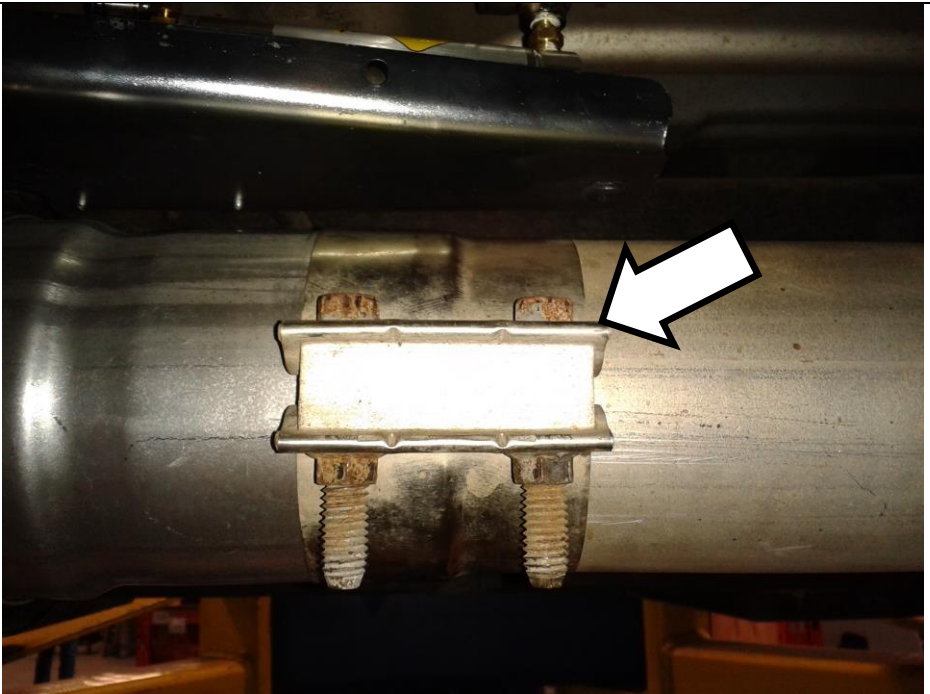

## Air Hose Installation

This kit is supplied with a premade air tubing assembly. The 1/8" air tube is the pressurized air feed to the brake pneumatic cylinder and the 1/4" air tube is the vent line for the cylinder.



Insert the 1/8" air tube into the quick connect fitting on the quick release valve on the air cylinder.

Insert the 1/4" tube into the vent-side quick connect fitting.

Feed the air tubing assembly over the top of the frame rail and support it so that there is no stress on the air tubes where they enter the brake valve.

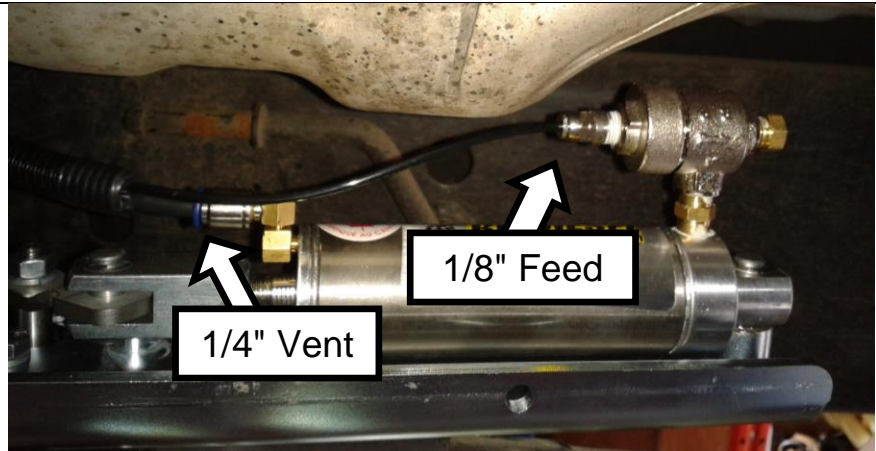

Route the air tubing assembly along the frame rail and secure with wire ties to the existing wiring harness.

Route the other end of the assembly into the engine bay up the passenger side of the firewall. It will be connected later.

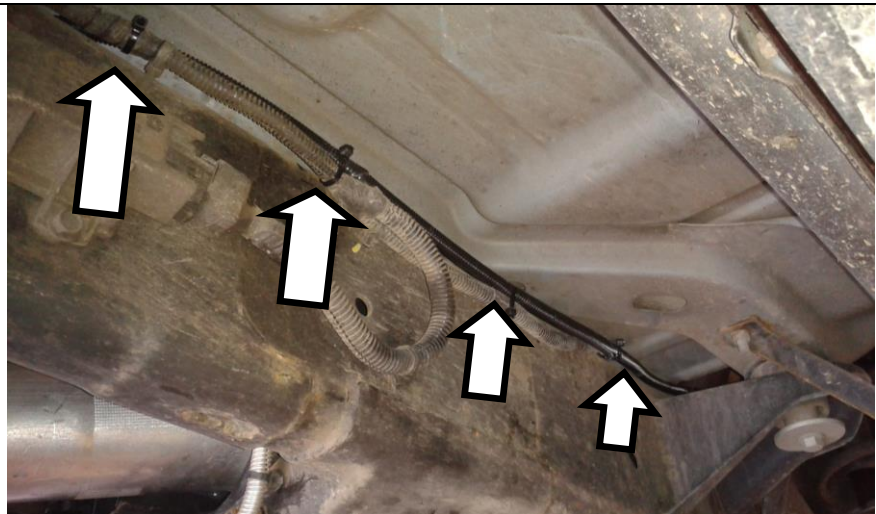

BD Engine Brake Inc.

Plant Address: 33541 MacLure Rd. Abbotsford, BC, Canada V2S 7W2

U.S. Shipping Address: 88-446 Harrison St, Sumas, WA 98295 U.S. Mailing Address: P.O. Box 231, Sumas, WA 98295

Phone: 604-853-6096 | Fax: 604-853-8749 | Internet: www.bd-power.com

## Air Compressor Mounting Installation

Remove the passenger side front wheel and remove the plastic fender liner from the vehicle to gain access to the inner fender area.

Install the supplied vibration dampening foam tape to the bottom back side of the compressor bracket assembly.



Locate the two mounting points for the compressor.

The compressor bracket is designed to line up with the front hood hinge bolt and an existing hole in the inner fender.

Remove the hood hinge bolt now to allow for installation of the compressor bracket.

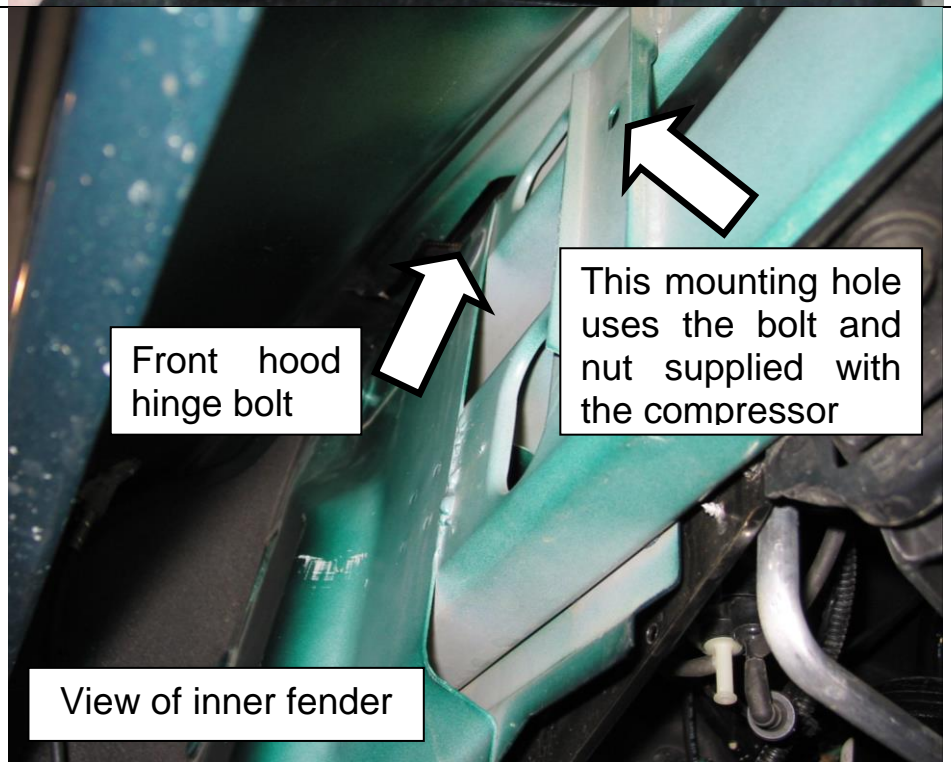



**Note** On 2013-2018 trucks there is an air intake tube inside the fender. This tube ends before the BD compressor bracket, but it may still be easier to install the compressor assembly with this tube removed.

The easiest way to remove this tube is by removing the air box from the engine bay side.

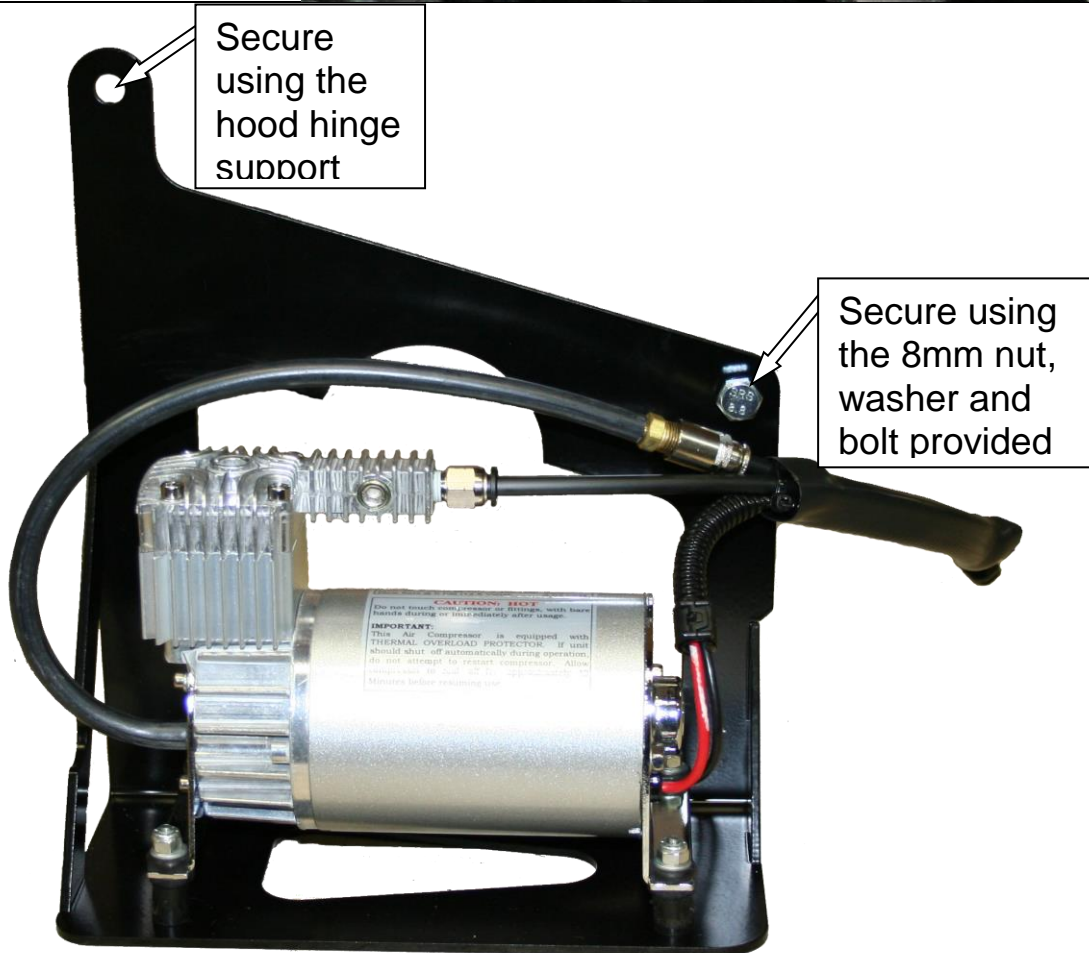
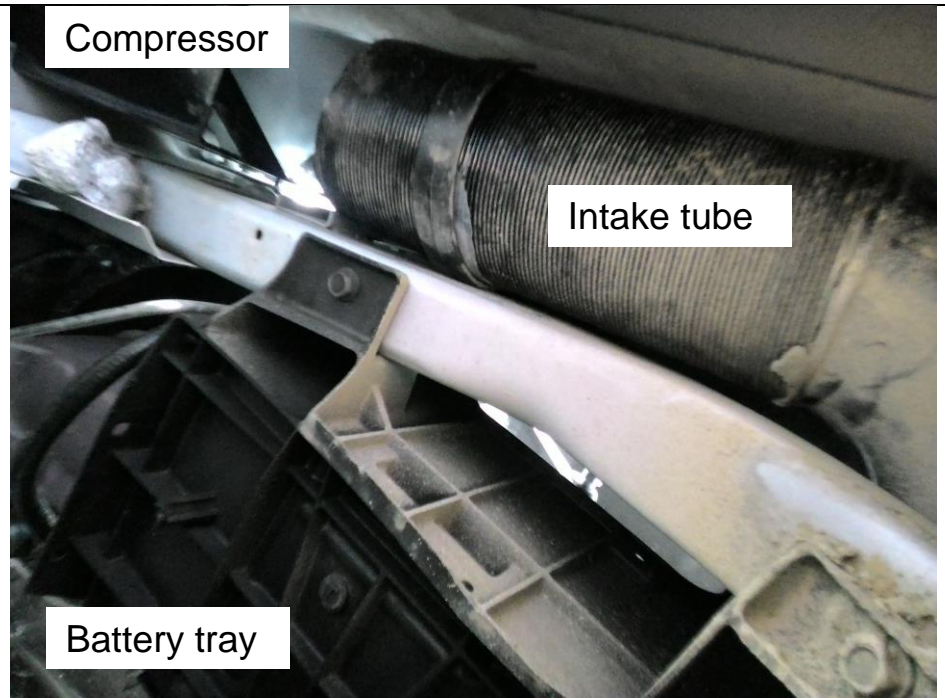



Feed the compressor air lines and wire through the fender into the engine bay, they will be connected later. Lift the compressor into place.



Secure the compressor in place by reinstalling the hood hinge bolt through the compressor bracket. Then install the nut and bolt to hold the front of the bracket.



While the fender liner is off, double check that the air tubing assembly installed in the earlier section is well clear of the exhaust pipe, turbocharger and moving suspension components.

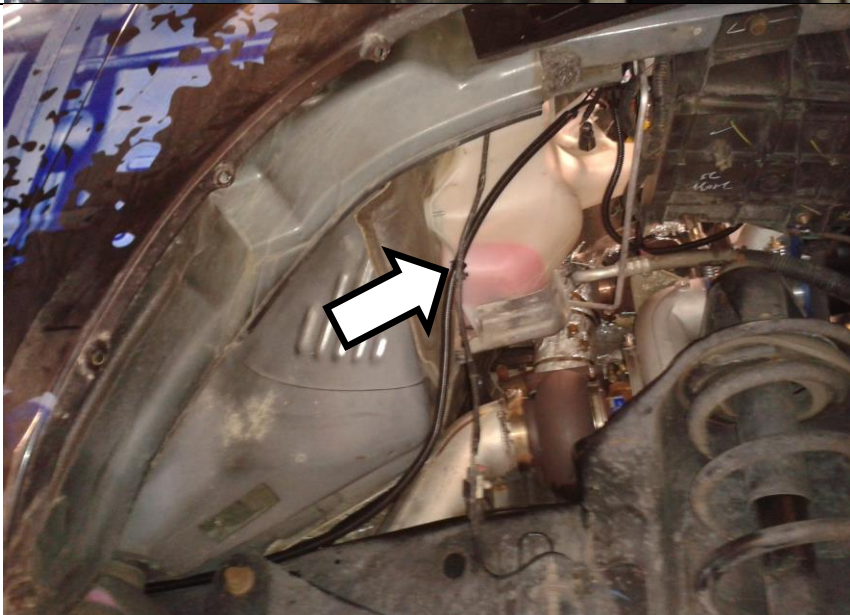

BD Engine Brake Inc.

Plant Address: 33541 MacLure Rd. Abbotsford, BC, Canada V2S 7W2

U.S. Shipping Address: 88-446 Harrison St, Sumas, WA 98295 U.S. Mailing Address: P.O. Box 231, Sumas, WA 98295

Phone: 604-853-6096 | Fax: 604-853-8749 | Internet: [www.bd-power.com](http://www.bd-power.com)

## Regulator Installation

The air pressure regulator assembly is to be mounted at the top of the firewall on the passenger side of the engine bay. The included washer should go directly under the head of the screw to sandwich the sheet metal against the regulator bracket.

### 2007-2009 Vehicles

There is a large oval hole in the existing sheet metal on the top of the firewall, this may be used to mount the regulator.

Alternatively, a new 3/8" hole may be drilled to install the regulator.

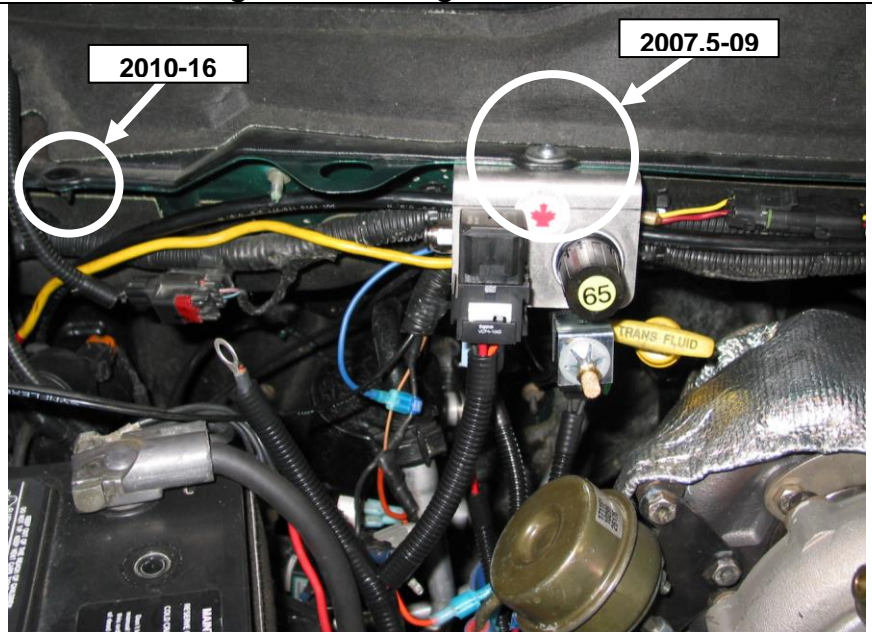

### 2010-2017 Vehicles

Remove the plastic trim clip or wiring harness clip on the top of the firewall near the coolant bottle. This hole will be used to install the regulator assembly.



BD Engine Brake Inc.

Plant Address: 33541 MacLure Rd. Abbotsford, BC, Canada V2S 7W2

U.S. Shipping Address: 88-446 Harrison St, Sumas, WA 98295 U.S. Mailing Address: P.O. Box 231, Sumas, WA 98295

Phone: 604-853-6096 | Fax: 604-853-8749 | Internet: www.bd-power.com



## Regulator Plumbing

Connect the air pressure line from the pump to the inlet of the regulator assembly.

This is the shorter of the two 1/4" tubes from the compressor that does not have a fitting on the end. This connects to the passenger side of the regulator assembly, behind the relay.

Trim this tube to length and insert it into the fitting.

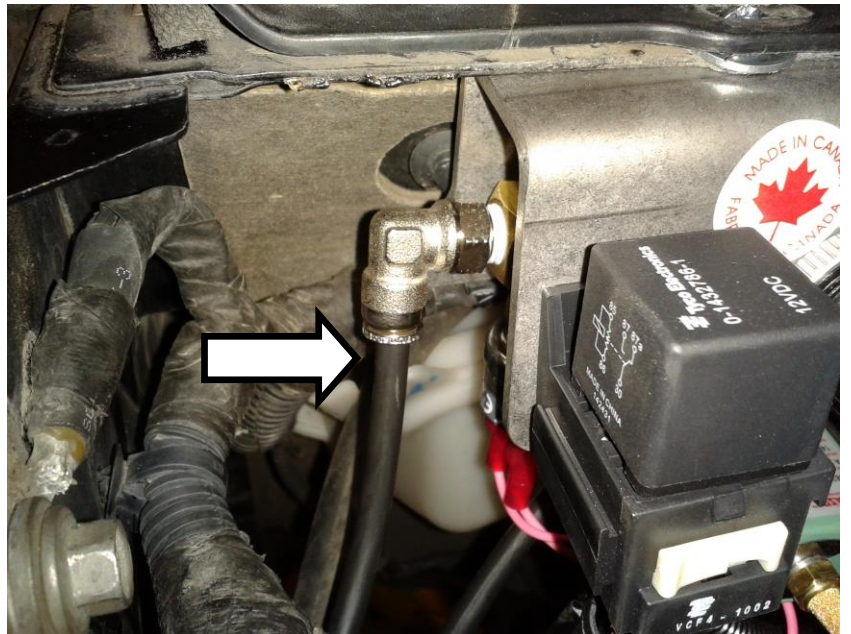

The other line from the compressor is the air suction line. This line is 1/4" diameter and comes with a preinstalled threaded adapter. Install the threaded filter supplied with the air pump into this fitting.



Route both the 1/4" suction line from the air pump and the 1/4" vent line from the air cylinder tube assembly to the driver side of the engine bay.

Secure with zip ties to keep the lines up off the motor.

Trim tubes to length if required.

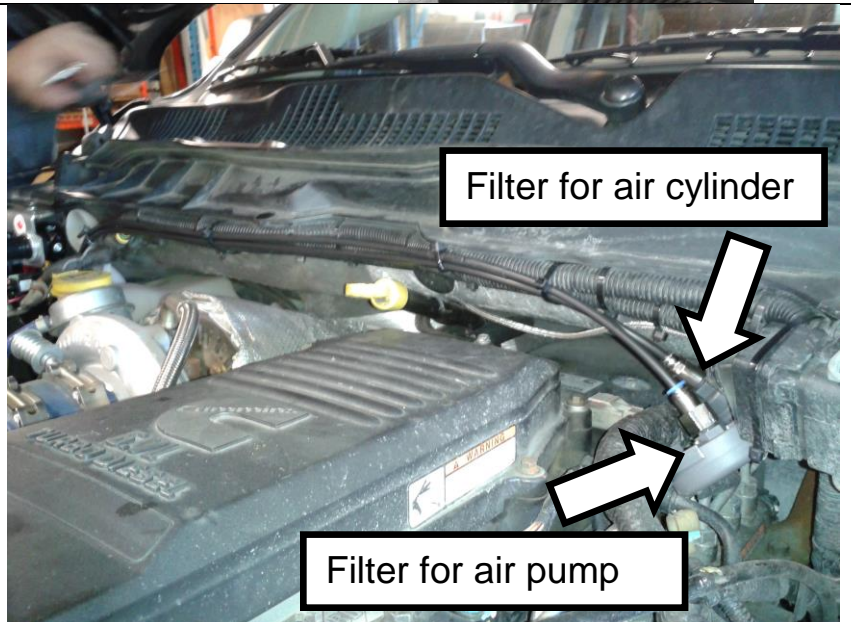

On 2007-2010 trucks, the preferred method of mounting the compressor air filter is just below the hood using a factory mounting location.

The sound deadening material is retained with plastic push in retainers. Remove this retainer and reinstall the air filter using its integral push in clip.

This is not possible on the 2010-2012 models due to the lower hood height.



Locate the 1/8" tube from in the air tubing assembly that leads to the brake valve. This will be installed in the output from the air regulator assembly on the bottom of the solenoid.

Trim this tube to length and install it in the 1/8" fitting.

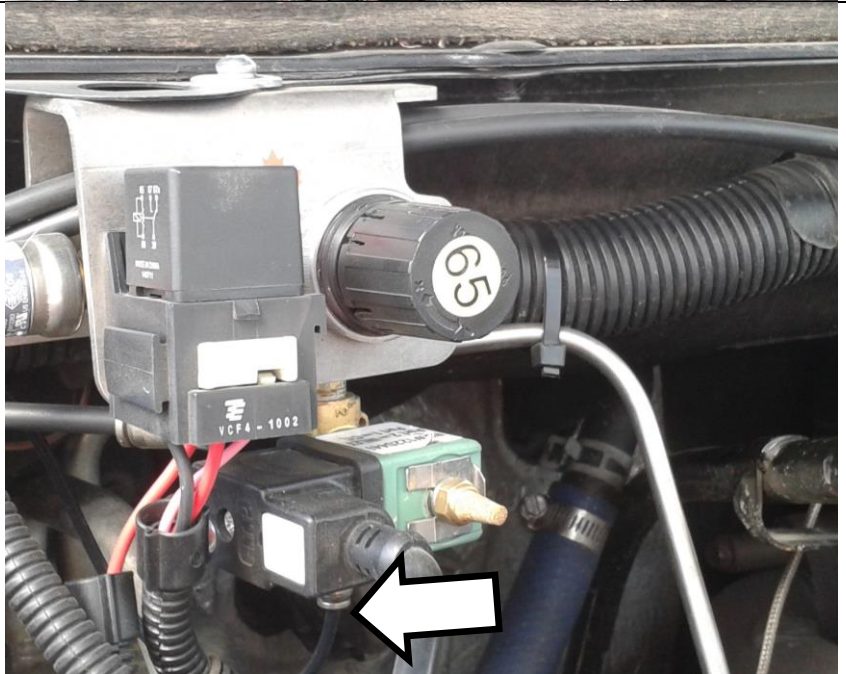

Refer to the wiring and plumbing diagram for more details.



## Electrical Connections

Connect the main ground connection to the body ground on the passenger side of the engine bay near the regulator assembly.

This is the black wire with a ring terminal installed on the end.

Alternatively this may be connected directly to the battery negative terminal if desired.

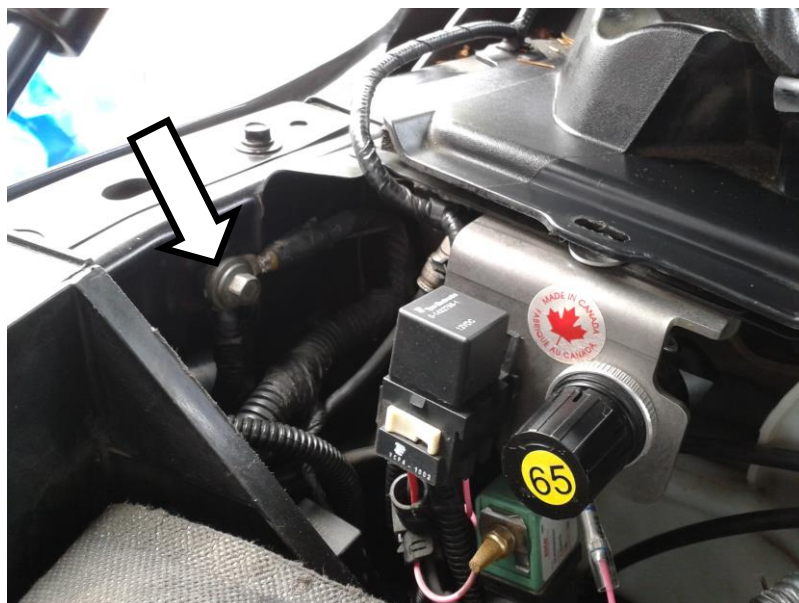

Connect the main power feed to the passenger side positive battery terminal clamp.

This is the red wire with a ring terminal installed on the end.

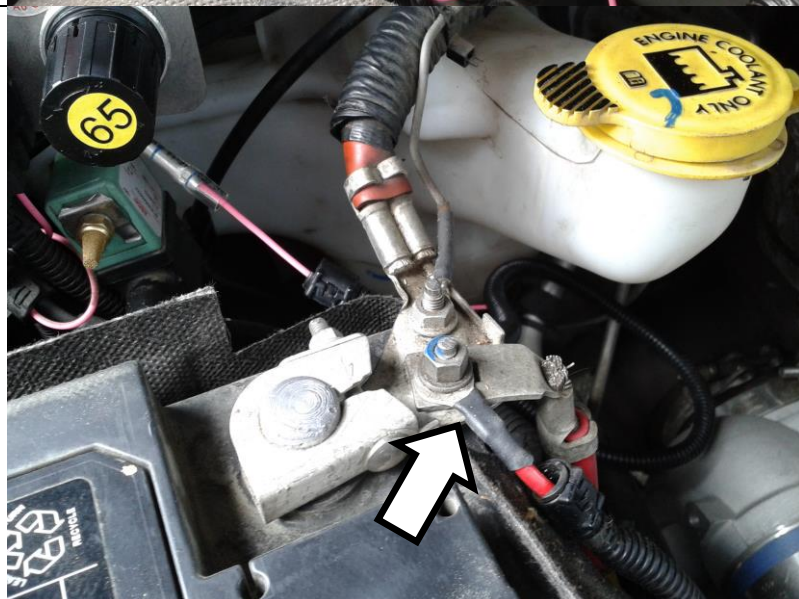

Locate the factory turbocharger actuator electrical connector. For 2008-2012 this is a light gray connector located near the oil pan on the passenger side of the engine. For 2013-2018 this is a black 4 pin connector that previously plugged into the turbo. It will have been disconnected when the VGT turbocharger was removed. Connect this to the supplied wiring harness with the kit.

Note: Picture looking upwards.

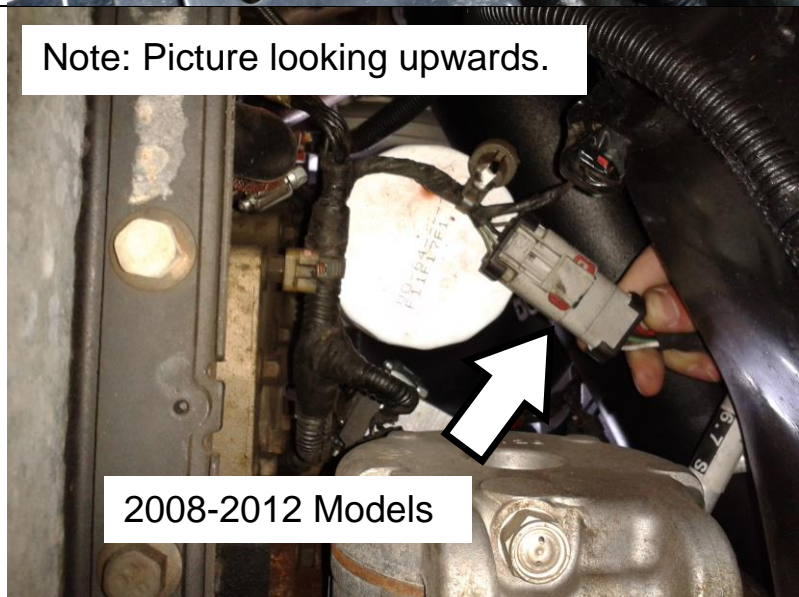

2008-2012 Models

BD Engine Brake Inc.

Plant Address: 33541 MacLure Rd. Abbotsford, BC, Canada V2S 7W2

U.S. Shipping Address: 88-446 Harrison St, Sumas, WA 98295 U.S. Mailing Address: P.O. Box 231, Sumas, WA 98295

Phone: 604-853-6096 | Fax: 604-853-8749 | Internet: www.bd-power.com

Route this electrical harness up to the same location as the exhaust brake air regulator assembly.

Connect the wiring harness to the module and secure the harness with wire ties to keep it well clear of the turbocharger(s).



Connect the pink trigger wire from the module harness to the air regulator assembly's pink wire using the pre-installed butt connector.

Heat-shrink this connector for a waterproof seal using a heat gun or lighter.

Mount the module with wire ties behind the battery tray, near the regulator assembly.

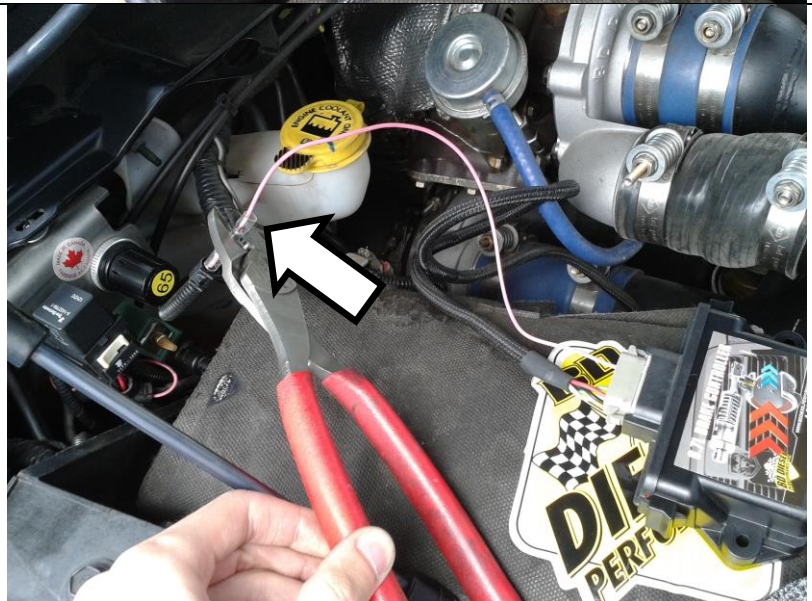

Refer to the wiring and plumbing diagram for more details.

BD Engine Brake Inc.

Plant Address: 33541 MacLure Rd. Abbotsford, BC, Canada V2S 7W2

U.S. Shipping Address: 88-446 Harrison St, Sumas, WA 98295 U.S. Mailing Address: P.O. Box 231, Sumas, WA 98295

Phone: 604-853-6096 | Fax: 604-853-8749 | Internet: www.bd-power.com

# Wiring & Plumbing Diagram

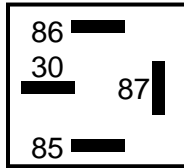

### Relay Wiring

- 30 - Air Compressor (Red)
- 85 - Ground (Black)
- 86 - Pressure Switch (Pink)
- 87 - 12V Battery (Red)

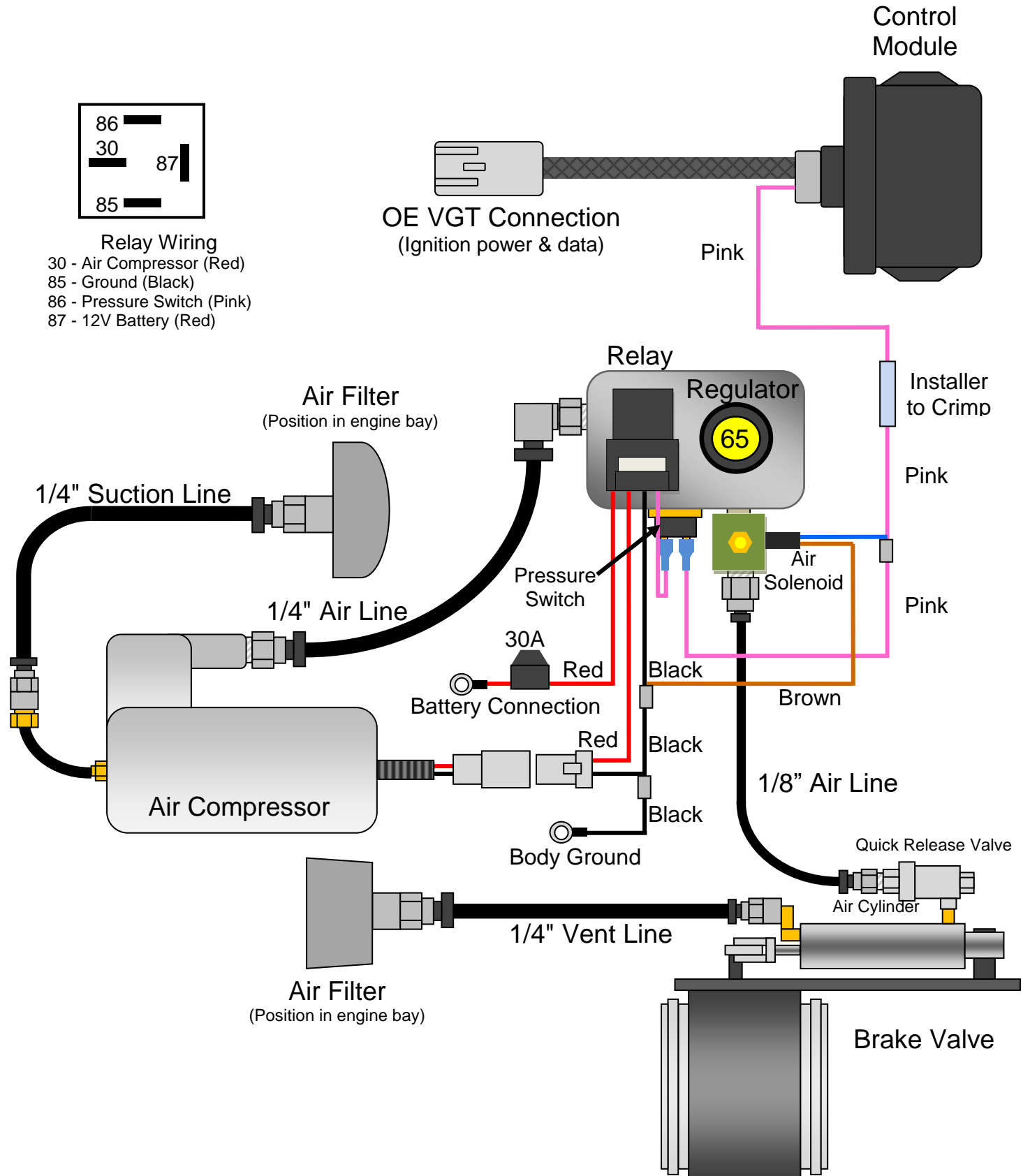



## ***Exhaust Back Pressure Testing for Air Actuated Brakes***

To test exhaust brake system pressure, a minimum 0-100psi pressure gauge is required.

We recommend purchase of a BD brake pressure gauge kit #1030050.



To test the idle pressures, the exhaust brake must be applied at idle. If the engine is cold, the brake will turn on when at idle, otherwise it must be commanded manually.

To turn the brake on for testing, remove the cover from the control module and press the "TEST" button inside. Pressing this button will energize the brake air solenoid and run the pump as necessary.

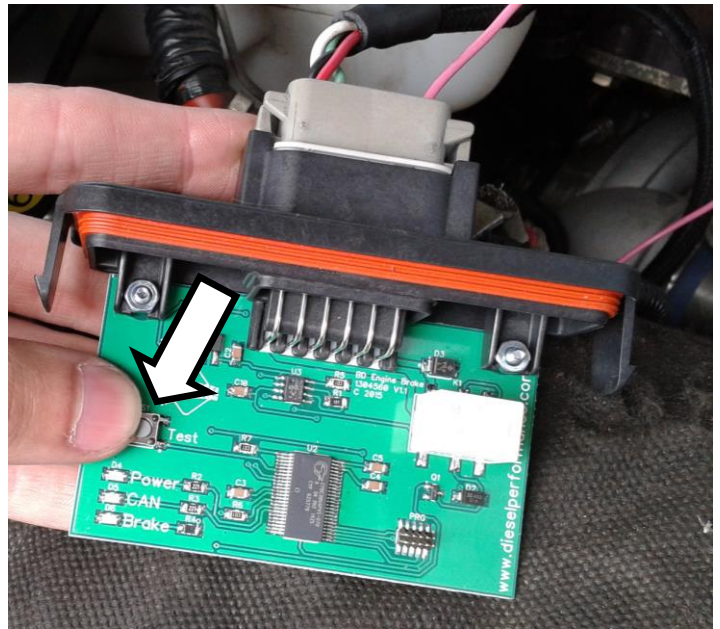

**You do not need to measure the air pressure in the system, just the exhaust backpressure, which is located on the cast valve.**

BD Engine Brake Inc.

Plant Address: 33541 MacLure Rd. Abbotsford, BC, Canada V2S 7W2

U.S. Shipping Address: 88-446 Harrison St, Sumas, WA 98295 U.S. Mailing Address: P.O. Box 231, Sumas, WA 98295

Phone: 604-853-6096 | Fax: 604-853-8749 | Internet: [www.bd-power.com](http://www.bd-power.com)



## Idle Pressure Test

With the BD brake engaged and the engine at idle check the exhaust backpressure using a pressure gauge (such as BD PN 1030050) at the test port on the brake valve.

If the back pressure is below 13 psi at idle you have a number of likely causes. The most common being an exhaust leak either at the clamp joint or at the welds (only on some models). Apply the exhaust brake and have someone assist you looking for soot trails or the visible leak. Another culprit would be an exhaust manifold leak, turbocharger gasket leak, turbocharger problem or an EGR issue.

If the back pressure is greater than 25psi, you will need to make an adjustment on the stop bolt. Loosen the jam nut, and lengthen the stop bolt towards the actuator, this will shorten the stroke distance. Only turn 1/4 rotation at a time and re-secure the jam nut. Retest idle pressure.

**NOTE: The brake stop-bolt and regulator have been preset at the factory and should not need to be adjusted.**

We generally do not recommend adjusting the stop bolt, please consult BD before doing this as it may void your warranty.



BD Engine Brake Inc.

Plant Address: 33541 MacLure Rd. Abbotsford, BC, Canada V2S 7W2

U.S. Shipping Address: 88-446 Harrison St, Sumas, WA 98295 U.S. Mailing Address: P.O. Box 231, Sumas, WA 98295

Phone: 604-853-6096 | Fax: 604-853-8749 | Internet: www.bd-power.com

## Off-Idle Pressure Test & Adjustment

Your BD exhaust brake is a variable-orifice design so when the brake is active and the engine is at higher RPM the brake lever does not rest on the stop bolt. Off-idle backpressure is set by adjusting the air pressure regulator which will in turn increase or decrease off-idle exhaust backpressure. You will need to secure your pressure gauge somewhere that you can see it while you are driving. Using a long extension hose & bringing the gauge into the cab through an open window or clipping it under a windshield wiper works well.

Get the truck up to speed (a downhill grade or a load in the truck is helpful) and activate the exhaust brake. Note the maximum backpressure achieved. You should get peak backpressure at higher RPM (try 3000 RPM in Drive). If you cannot reach the desired backpressure (compare table below) you can begin troubleshooting, the first step is to look for exhaust leaks either from the clamps, exhaust manifolds or feed pipes. Also look for leaks at the clamps located at the back of the turbo and also at the down pipe. If all connections are sealed, you can then use the adjusting regulator to increase the backpressure. Note that small regulator adjustments can have a significant effect on off-idle backpressure.

Turning the regulator **clockwise** will increase pressure.

Turning the regulator **counter clockwise** will decrease pressure.



**NOTE:** Over the next two weeks, the backpressure at idle may rise due to initial carbon build up on the inside of the brake housing and on the butterfly. The stop bolt may need to be adjusted again to compensate.

Application	Maximum Back Pressure
GM/Chevy 6.5	35 psi
GM/Chevy Duramax	55 psi
Ford Powerstroke	45 psi
Dodge Cummins 1988-98 12V w/o 60lbs Springs	40 psi
Dodge Cummins 1988-98 12V with 60lbs Springs	60 psi
Dodge Cummins 1998 to current	65 psi

\*HD Spring part# is 1030060.

**CAUTION:** Do NOT exceed the maximum back pressure value in the exhaust system. Exceeding this pressure will force the exhaust valves open during the intake stroke which could cause engine damage.

BD Engine Brake Inc.

Plant Address: 33541 MacLure Rd. Abbotsford, BC, Canada V2S 7W2

U.S. Shipping Address: 88-446 Harrison St, Sumas, WA 98295 U.S. Mailing Address: P.O. Box 231, Sumas, WA 98295

Phone: 604-853-6096 | Fax: 604-853-8749 | Internet: www.bd-power.com

## ***Maintenance***

To extend life of the exhaust brake, do not operate the vehicle for extended periods of time without activating the brake. We suggest activating the exhaust brake at least a couple times a day while operating the vehicle to prevent any carbon or rust build up on inner parts of the brake valve assembly.

The hoses, wires, fittings and clamps should be inspected on a regular basis for any deterioration, damage or leaks.

**To increase the life of your exhaust brake, we recommend daily operation. By simply switching the brake on and off a couple times a day, it will prevent the butterfly valve from sticking due to carbon build-up.**

Following the diagrams in this manual, tracing hoses and wiring, checking continuity through electric components or checking for any lines that are disconnected, should solve any problems that may arise. If you have any problems or need replacement parts, call us at 1-800-887-5030, between 8:30am and 5:00pm Pacific Time.

## ***Operating Guidelines***

Thank you for taking interest in the BD Engine Exhaust Brake. As a driver, you probably already know the need for extra braking power that your vehicle requires on the hills and long grades. With loads being towed behind you, the extra push when slowing down or maintaining speed on downward grades can prove to be a great strain on your vehicles hydraulic braking system, even to the point of “burn-up”. These guidelines were designed to offer you a better understanding of the benefits of exhaust brakes and are partly based upon material developed by the U.S. Department of Transportation National Highway Traffic Safety Administration.

The emphasis on today’s vehicles is to give the consumer a product that can give them usable power with fuel efficiency. But, in the transition, the vehicles have lost their natural braking power, making it more easy for the vehicle to continue to roll and harder to stop. Of course, this gets more noticeable with the increase of weight, on or behind the vehicle. This is where an exhaust brake becomes a useful tool in increasing the driveline drag of the vehicle without the use of the hydraulic brakes; a tool that with maximum use or even occasional use can reduce wear on hydraulic braking parts and at the same time increase safety.

The BD Exhaust Brake can be used to help maintain a controlled vehicle speed on a downward grade, as well as slowing the vehicle down for such times as turns or exit ramps, without you using your hydraulic brakes. **But, the exhaust brake cannot be used as a parking brake will not bring your vehicle to a complete stop.** By using a BD Exhaust Brake, the life and effectiveness of your hydraulic brakes will increase.

BD Engine Brake Inc.

Plant Address: 33541 MacLure Rd. Abbotsford, BC, Canada V2S 7W2

U.S. Shipping Address: 88-446 Harrison St, Sumas, WA 98295 U.S. Mailing Address: P.O. Box 231, Sumas, WA 98295

Phone: 604-853-6096 | Fax: 604-853-8749 | Internet: www.bd-power.com



This is because of the decreased use of the hydraulic brakes in situations like hills, the wear factor is reduced and there is less opportunity for your hydraulic brakes to heat up which would reduce the efficiency. When you ride your hydraulic brakes, make hard stops or have poorly adjusted brakes, this creates high temperatures and as your brakes get hotter, the more chance there is for failure.

With terrain that is a series of up and down grades, the BD Exhaust Brake will help reduce warping in the exhaust valves. Because of the power needed to pull your vehicle and load up a hill, this generates a lot of heat. When you have reached the crest of the hill and are coasting down the other side, the heated valves are cooled too quickly. With the exhaust brake engaged, the heat loss to the valves will be reduced, which can prevent valve warping.

When the toggle switch is turned to the "On" position, the valve is activated every time the driver takes his foot off of the throttle pedal. When the driver puts pressure back on the throttle pedal, the DFIV/switch is deactivated and the valve opens again.

Exhaust brakes are designed to operate with the throttle at idle - not to be used in conjunction with cruise controls, and not designed to aid in gear shifting.

Such cases may cause damage to engine and/or exhaust brake. There is a pressure regulating system incorporated with the BD Exhaust Brake that will control the created backpressure. If the backpressure reaches the set limit while under engine braking, the exhaust valve will open slightly to relieve the excess pressure.

The best scenario for exhaust braking is when going down hill, select a gear that lets you maintain a constant speed with little or no use of the hydraulic brakes, or the same gear that would be used to go up the same grade of hill. This also depends on the weight, load or road conditions that the vehicle will come upon. So, in summary, by using the BD Exhaust Brake, you reduce the need for use of your hydraulic brakes in situations where you need to slow down or maintain speed (i.e. hills, off ramps, corners, approaching speed changes or traffic lights). Reducing the use of your hydraulic brakes in these situations will reduce the heat build up, as well as wear and damage to linings and drums. And, when you reduce these factors, you save your hydraulic brakes for when you really need them (for stopping or emergencies).

The BD Exhaust Brake is not a substitute for your hydraulic brakes and, cannot correct or compensate for poorly maintained or misadjusted brakes. But, when you need to slow down or maintain a constant speed, the BD Exhaust Brake will be a valuable and effective tool. Exhaust Brakes are more efficient at preventing rather than correcting an over speed condition.

## Troubleshooting

This guide assumes that your exhaust brake system is using a "Dodge 6.7L Brake Control Module" rather than a DFIV or micro-switch on the throttle. For other systems see the appropriate instruction manual.

Brake does not engage	No	Yes
<p>Is the control module powering the trigger output wire?</p> <p>Open module and observe the "BRAKE" led, this will light when the module activates the output.</p>	<p>Is the module powered? Check fuse box for blown fuse.</p> <p>2007-2009 MY Fuse #37 - 15A 2010-2012 MY Fuse M21 – 20A 2013-2017 MY Fuse 78 – 10A</p> <p>Check wiring harness for connection or for damage.</p> <p>Also check power &amp; ground at pump relay and make sure the air solenoid has a good ground.</p>	<p>Check that when air solenoid is powered it will allow air to flow from the #2 port out the #1 port.</p> <p>Check that pump relay is powering pump. If pump has power but does not run, pump is likely faulty. Check for power &amp; ground at pump relay, if these are good but relay does not click or does not power pump, relay is likely faulty.</p>
The brake comes on but there's little or no holdback	No	Yes
<p>Check off idle brake pressure. (See back pressure chart)</p> <p>Are you getting maximum allowable backpressure at full RPM?</p>	<p>Check for exhaust leaks. A small leak can result in a significant decrease in back pressure. If no leaks are found try adjusting air regulator. Check for air leaks in brake system.</p>	<p>Try down shifting more aggressively. More RPM will give more holdback. Transmission or torque converter could be slipping internally.</p>
Everything seems to work, but the brake valve won't close	No	Yes
<p>Check that air is reaching brake air cylinder?</p>	<p>Air solenoid or quick release valve are likely stuck, plugged or faulty. Clean or replace as required.</p>	<p>Cylinder or brake valve are seized. Remove the clevis pin on the end of the cylinder rod &amp; see if the valve lever can be moved freely.</p>
<p>The valve lever can be moved freely?</p>	<p>Try dismantling the brake &amp; cleaning the carbon out of it. If this does not work the brake valve will need to be replaced.</p>	<p>The cylinder is stuck and will need to be replaced.</p>
Problem	Solution	
<p>Air compressor runs in short bursts and brake is slow to apply.</p>	<p>There is a restriction in the air system, normally in the regulator or air solenoid. Remove the fittings from the regulator and air solenoid, you will likely find some corrosion or debris caught in them. Clean this out with a pick, small brush, compressed air and WD40 or similar lubricant.</p>	
<p>Air compressor runs continually.</p>	<p>Pump relay is likely stuck on. Check operation of relay &amp; replace as required.</p>	
<p>Brake is slow to release.</p>	<p>Debris or corrosion is restricting the quick release valve or air solenoid. Clean as required.</p>	

Thank you and happy motoring.  
BD Engine Brake, Inc.