



**DOWNLOAD ENHANCED
INSTALL MANUALS AT
*dieselperformance.com***



BD TorqLoc

Torque Converter Control System

Part# 1030395

Installation Manual for the following applications:

BD Brakes for Dodge, Ford and Chevrolet

Pac Brake for Dodge & Ford

Jacobs E-Brake for 1994-98 Dodge 6BTA 12 Valve

*** Please read this instruction manual before starting installation ***

BD Engine Brake Inc.

Plant Address: 33541 MacLure Rd. Abbotsford, BC, Canada V2S 7W2

U.S. Shipping Address: 88-446 Harrison St, Sumas, WA 98295 U.S. Mailing Address: P.O. Box 231, Sumas, WA 98295

Phone: 604-853-6096 | Fax: 604-853-8749 | Internet: www.bd-power.com

TABLE OF CONTENTS

WELCOME.....	2
The BD TORQLOC Advantage	2
Operating the BD TORQLOC.....	3
Transmission Quirks	4
Compatibility With Other Exhaust Brake Brands.....	4
Adjusting For Application.....	5
Wiring the TORQLOC (with an exhaust brake).....	7
Testing The TORQLOC (with an exhaust brake).....	10
Testing the TORQLOC (without an exhaust brake)	12
Dodge “TRANS” Relay Bypass (1996-2000).....	14
BD TORQLOC WIRING DIAGRAMS -	15
· BD BRAKES: 1995-2003 FORD 7.3L / 1999-2005 DODGE 24V.....	15
· BD BRAKES: 1994-1998 DODGE / 1988-94 FORD IDI / CHEVY 6.2-6.5L.....	16
· PAC BRAKE: DODGE 12V	16
· PAC BRAKE: 1995-97 FORD POWERSTROKE.....	17
· JACOBS E-BRAKE: DODGE 12 Valve	18
· PAC BRAKE: DODGE ISB 24 VALVES.....	19
· JACOBS BRAKE: DODGE ISB 24 VALVES.....	19
· US GEAR D-CELERATOR BRAKES.....	19
· NO EXHAUST BRAKE INSTALLED	19
AUTOLOC vs. TORQLOC	20
Questions?	21

WELCOME

Thank you for purchasing the BD **TorqLoc** Kit. This manual is to aid you with your installation and operation of the unit. We strongly suggest that you retain this manual for any future reference.

NOTE: For trucks with a Jacobs Exhaust Brake system for the Dodge ISB 24 valve application, and all US Gear D-Celerators, this brake cannot be hooked up to the module. Follow the instructions that are for “Without Exhaust Brake” on page 11.

The BD TORQLOC Advantage

Exhaust brake usage can cause high temperatures in the automatic transmission due to torque convertor slippage if a lockup device is not used. Only 10% to 80% of the retarding force is transferred through the fluid coupling of most torque convertors.

The **BD TorqLoc** commands the lock-up clutch of the torque convertor to stay engaged when the **BD Exhaust Brake** is activated. This allows up to 100% of the retarding force to be transferred while in 3rd and 4th gear. Also, transmission oil temperatures will remain low because of little or no slippage occurring in the convertor in these gears.

Operating the BD TORQLOC

The **TorqLoc** works off of a lighted 3-position toggle switch and will only take effect when the vehicle is above a set speed (approximately 25mph to 30mph) and the torque convertor lock-up clutch is engaged. The lock-up clutch usually engages when the vehicle is cruising with little throttle action.

On most vehicles, the lock-up clutch can be manually engaged by applying pressure to the accelerator pedal until lock-up engages, then lift foot off the accelerator. Accelerator pedal pressure is also required after shifting out of or into overdrive to reengage the lock-up. The **TorqLoc** is programmed to disengage the lock-up clutch once the vehicle's speed drops below a preset speed.

When the 3-Position toggle switch is in the **Down (Green light)** position, the **TorqLoc** module will keep the convertor lock-up clutch engaged when the exhaust brake valve is activated (brake switch turned on and accelerator pedal at idle position). (**NOTE:** The **Down** position has no operation if the **TorqLoc** module is not wired up to an exhaust brake.) The **Middle (White light)** position is the off/neutral position for the **TorqLoc** module. The **Up (Red light)** position will manually keep the convertor lock-up clutch engaged.

For proper operation of the **Dodge** transmission, the lock-up clutch must be disengaged before the transmission will shift out of overdrive into 3rd gear. The **TorqLoc** module compensates for this by disengaging the lock-up clutch when the "O/D" button is activated to turn the overdrive off while the exhaust brake is turned on. To reactivate the lock-up, apply pressure to the accelerator pedal until lock-up engages, then lift foot off of the accelerator pedal.

Also with **Dodge** trucks, to prevent excess slippage with the lock-up clutch, the turbo boost pressure should be equal to or less than 1psi for every 100 engine rpm (18psi or less at 1800rpm) when engine rpm is below 1800rpm.

On all vehicles, the transmission should be shifted out of overdrive if speed drops below 40 mph. If not, there could be a transmission shudder as the vehicle speed decreases until it reaches the set speed that the **TorqLoc** unit will allow the torque convertor lock-up clutch to disengage.

With **Dodge** trucks, the module has an Overdrive inverter option that will disengage the Overdrive when the truck starts to move after being started up. This will prevent possible transmission shudder on trucks with raised horsepower and will allow for the transmission to lock-up the clutch in third gear before reaching overdrive when starting to up-shift from a dead stop, allowing cooler fluid temperatures when driving at "city" speeds. This is an option and does not need to be connected for proper operation of the **TorqLoc** module, ignore all references to the "Inverter" if this option is not desired.

Note: The OD inverter is not compatible with 2005 Dodges. A BD Overdrive Cutout PN 1031350 may be purchased separately to control OD on a 2005 Dodge

BD Engine Brake Inc.

Plant Address: 33541 MacLure Rd. Abbotsford, BC, Canada V2S 7W2

U.S. Shipping Address: 88-446 Harrison St, Sumas, WA 98295 U.S. Mailing Address: P.O. Box 231, Sumas, WA 98295

Phone: 604-853-6096 | Fax: 604-853-8749 | Internet: www.bd-power.com

Transmission Quirks

Some Dodges built between the production dates of 09/95 to 04/96 have had computers that the programming for the transmission control has caused some lock-up control problems and/or will cause the **TorqLoc** not to operate correctly. If this occurs, the computer can be "re-flashed" to current specifications at most Dodge dealerships, labor charges (usually 1/2 hour) may apply.

Some Dodges that are of the 1999-up model years and are of California specifications may require the Transmission Relay to be reinstalled back into it's socket, which would have been removed in the "1996-up Dodge "TRANS" Relay Bypass" section of this manual.

Note that if you have installed the unit on a Ford and you have a higher autoloc unlock speed in overdrive or drive, you most likely have a coast clutch problem in the transmission. A BD Pressureloc can help to prevent this.

Other items installed that may effect the operation of the transmission may have an effect on the operation of the **TorqLoc** (i.e. auxiliary transmissions). Please make this known if contacting the BD Technical Service Department.

Compatibility With Other Exhaust Brake Brands

For the **Down (Green light)** position, where the **TorqLoc** module will keep the convertor lock-up clutch engaged when the exhaust brake valve is activated (brake switch turned on and accelerator pedal at idle position), most of the provided diagrams, instructions and parts relate to the installation and operation of this unit in conjunction with any BD Exhaust Brake.

In this manual, we have provided some diagrams and additional instructions for some of the other systems that we have had access to their diagrams. An installation in conjunction with any other system should only be done with instruction from one of our BD Technicians, with wiring diagrams and/or schematics provided to them. Additional lead-time, parts and/or labor may be required.

For Jacobs E-Brakes installed on Dodge trucks with the 24 valve ISB engines and all US Gear D-Celerator applications, ignore hooking up the **TorqLoc** to the brake wiring, and follow the wiring instructions as if there was no exhaust brake installed.

NOTE - Pac Brake exhaust brakes only: If the truck has a 6BTA 12 valve engine with 60lb springs, remove the Pac Brake valve and drill out the pressure relief hole from 9/32" to 31/64". This step is NOT required for the 24 Valve engines or newer models.

Adjusting For Application

Before installing, open the box up by removing two screws on bottom of module. On the opposite end of the circuit board from the terminals, there is selection of 8 "dip" switches. These dip-switches control the speed that the **TorqLoc** module will disconnect the lock-up clutch. We have provided settings for the module to disconnect the lock-up at approximately 25mph to 30mph. If you find that the set speed is too high or low for the vehicle, phone our technical service department for alternative settings.

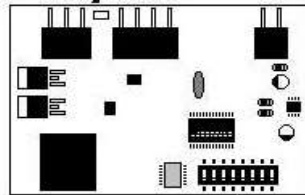

Dip Switches

Chevy

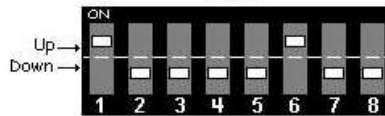

Dodge & Ford

4:10 Ratio





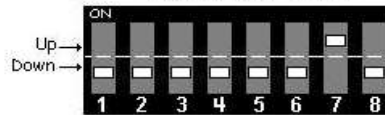







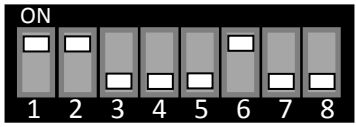
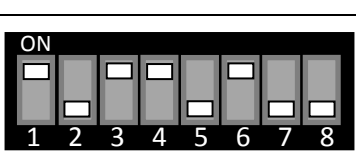
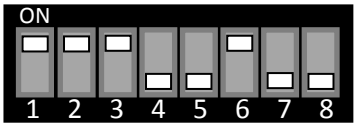

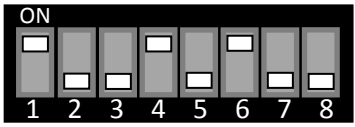





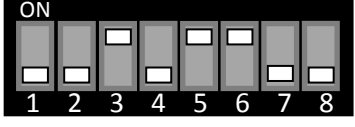
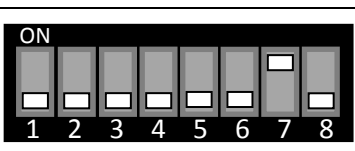

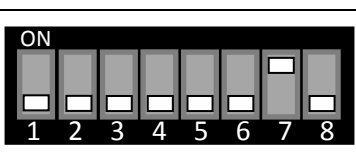

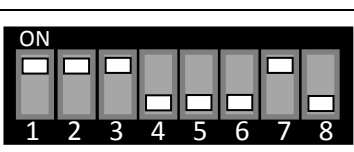

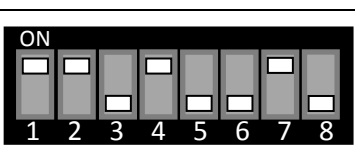
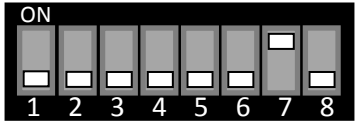
3:55 & 3:73 Ratios

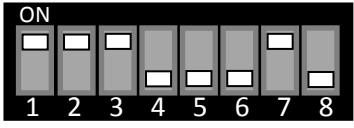
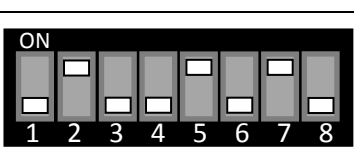

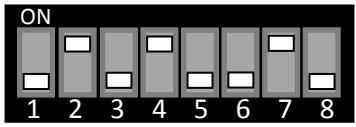
NOTE: To ensure proper function of the dip switches, flip each dip switch back and forth once before setting them, even if the dip switches are already set for the application it's being installed on.

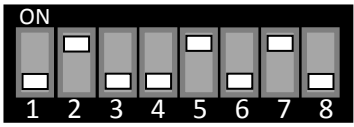
The "LED" (Light Emitting Diode) on the circuit board will show a Red light when the **TorqLoc** is functioning. Once the unit is installed, test drive the vehicle to make sure the light comes on and then turns off at the set speed.

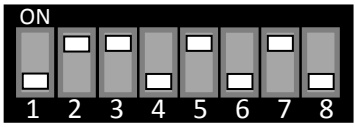
Additional Dodge/Ford DIP Switch Settings

	4.10 GEARS	3.73 GEARS	3.55 GEARS
20MPH	Up  Down 	Up  Down 	Up  Down 
25MPH	Up  Down 	Up  Down 	Up  Down 
30MPH	Up  Down 	Up  Down 	Up  Down 
35MPH	Up  Down 	Up  Down 	Up  Down 
40MPH	Up  Down 	Up  Down 	Up  Down 

Wiring the TORQLOC (with an exhaust brake)

Disconnect the ground (Negative) terminals on all vehicle batteries before starting installation. The following instructions are divided per wire going up to each individual terminal labeled on the **TorqLoc** module, and the terminals in these instructions will be numbered starting from the top at the +12V terminal. Follow along with the diagrams following the written instructions for ease of installation.

After wiring, additional instructions will follow for 1996-up Dodges. For 1999-03 Ford PowerStrokes, remove the driver's side front fender well for access to computer harness. When possible, check for continuity through all Posi-Tap™ connectors after you have installed them. We suggest soldering and shrink tubing all connections, but we also provide Posi-Taps™ for your convenience.

+12V	#1	TorqLoc power lead (Red wire)
Using a test light or multi-meter, find a key switched +12 Volt power source in the wiring harness under the dash. Connect the Red wire to it using a black Posi-Tap™ and connect the other end of the Red wire to the +12v terminal on the module.		

GND	#2	TorqLoc ground (Black wire)
Connect to any bolt/screw under the dash that is a good ground.		

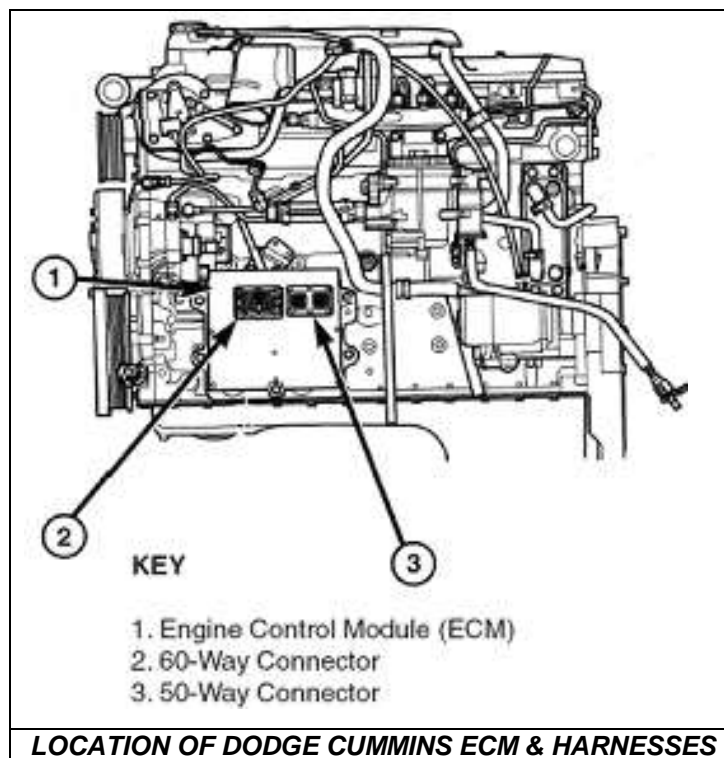

VSS	#3	Vehicle Speed Sensor (Green wire)
Locate the VSS (Vehicle Speed Sensor) wire in the vehicles computer wiring harness (see chart). Run the TorqLoc Green wire to the VSS wire and cut off any excess, leaving some slack. Connect to the VSS wire using a gray Posi-Tap™, or, solder the Green wire to the VSS wire and protect it from the elements (i.e. liquid electrical tape).		
DODGE (5.9L)	2004-2005	Pin 11 at ECM C2 50 pin (Dark Green w/Yellow tracer)
	1996-2003	Pin 27 at PCM C2 (White w/Orange Tracer)
	1994-1995	Pin 47 on PCM (White w/Orange Tracer)
FORD (7.3L)	1995-2003	Pin 58 at ECM (Gray w/Black Tracer)
	1990-1994	Pin 3 at ECM (Gray w/Black Tracer)
CHEVY (6.5L)	1994-2000	Pin 15 (Dark Green) at VSS Buffer beside the ECM (Behind glove box)
	1992-1993	Light Blue w/Black Tracer at VSS Buffer by ECM

BPS	#4	Brake Power Signal (Brown Wire)
The module is looking for the 12-volt positive signal that triggers the exhaust brake to activate. Use the chart below and wiring diagrams at the back of this manual to make the correct connection.		
Brake System		Connection
BD Brake (except Ford PowerStroke) & Pac Brake (Dodge Application)		Posi-Tap™ onto the wire leading from the DFVI to the exhaust brake solenoid.
BD Brake (Ford PowerStroke)		Cut the wire leading from the Throttle Relay to the Control Valve for the exhaust brake valve. Using a Blue Butt connector, attach the Brown wire to the wire coming from the Throttle Switch/Relay (See “ #9 Engine Brake ” on the page 9 for the connection to the wire going to the Control Valve for the exhaust brake.)
Pac Brake (1994-97 Ford PowerStroke)		Posi-Tap™ onto the blue wire running from the toggle switch to the Vacuum Control Solenoid.
Jacobs E-Brake (Dodge 6BTA)		Posi-Tap™ onto the black wire on the wire harness at the throttle switch.

O/D SW	#5	Dodge Overdrive Switch (<i>White wire</i>)
<p>For 1994-98 Dodges, locate the Lt. Green w/Orange Tracer wire, or, the Orange w/White on 1999-up Dodges, in the harness above the master brake cylinder (NOTE: The same harness that the VSS wire is usually found) or PCM C3 Pin 13. For 2004 Dodges, locate the Dark Green wire at the ECM on the driver side of the engine. Pin 13 on the ECM C2 connector (50 pin). 2005 Dodge trucks do not have an OD off wire and do not use this function.</p> <p>Cut the White wire to length, while leaving some slack. Connect to the overdrive wire using a gray Posi-Tap™ connector, or solder the White wire to O/D wire and protect from elements (i.e. liquid electrical tape)</p>		

PCM & TCC	#6-7	Converter Control (<i>Yellow #6 and Blue #7 wire</i>)
<p>Locate the vehicle's Torque Converter Control (TCC) as described in the following chart. Cut the applicable wire and attach one side of a blue Posi-Lock connector to the wire leading back to the transmission, and, attach one side of another blue Posi-Lock connector to the wire heading to the vehicles computer (ECM or PCM).</p> <p>Connect the TorqLoc Yellow wire to the PCM (#6) terminal on the module, and, connect the Blue wire to the TCC (#7) terminal. Run the Yellow and Blue wire to the cut Converter Control wire and cut off leaving some slack. Attach the Yellow wire to the blue Posi-Lock heading to vehicle's computer. Attach the Blue wire to the blue Posi-Lock heading back to the transmission. Instead of connectors, you could also solder the wires.</p>		

NOTE: Some vehicles have more than one wiring harness on transmission.

Make/Model	Year	Wire Color	Pin #	Location
DODGE (5.9L)	2004-2005	Y/LB	25	ECM C2 50 Pin Connection
	1996-2003	OR/BK	11	PCM C2
	1994-1995	OR/BK	54	PCM
FORD (7.3L)	1999-2003	VT/Y	54	PCM
	1995-1997	VT/Y	28	PCM
	1990-1994	VT/Y	53	PCM
CHEVY	1994-2000	Unplug harness from transmission then look inside plug and identify which wire is going to the "S" pin		

(6.5L)		(usually Brown)	
	1992-1993	TAN/BK	“J” on Transmission

INVERTER	#8	Optional Overdrive Disable (<i>Orange Wire</i>)
<p>For 1994-98 Dodges only, connect Orange wire to the Inverter terminal and run it to the same harness where the O/D Switch and VSS wire were found, cutting of excess and leaving some slack. Locate the Orange w/White Tracer and using a gray Posi-Tap™ connector or soldering, connect Orange wire to O/D wire.</p>		
<p>For 1999-2002 Dodges, if the overdrive inverter option is desired, flip Dip Switch #8 to the “UP” position, no matter what gear ratio you set the other switches to.</p>		

BRAKE	#9	N/A
<p>This connection is not used in the <i>TorqLoc</i> kit.</p>		

Testing The TORQLOC (with an exhaust brake)

With the module pulled out enough to be easily visible while driving, take the vehicle for a drive. Turn the brake on and first check that the LED light comes on once the vehicle has surpassed the set speed. On some Ford trucks the LED will only come on above the set speed when the throttle is returned to idle. If the LED fails to illuminate after the set speed, check the dip-switch settings, the VSS wire color and the connection to that wire, the wire is on the right terminal at the module, and make sure there is a good power source and ground for the module.

With no traffic around, turn on the exhaust brake then cruise at a constant speed above the set speed on the module, then let off the throttle. The brake should have activated and you should feel the hold back. Turn the brake off to make sure the brake and lock-up clutch disengages. Turn the brake on and cruise again at a constant speed, then let off the throttle and let the vehicle slow down below the set speed, making sure the lock-up releases below the set speed. If these situations fail to occur, then check the wiring to the brake and module, and check terminal locations on the module.

On Dodges, after starting up the truck and starting drive, the O/D off light should have illuminated (if that option was hooked up). With the brake turned on, drive until overdrive is reached then let off the throttle. With the brake and lock-up clutch engaged, push the overdrive button to check that the lock-up clutch disengages and the transmission shifts out of overdrive. If this fails to occur, check the O/D wire color and connection to that wire, and that the wire is on the right terminal at the module.

If any of the functions still fail to occur, phone our technical service department for further assistance. If it is necessary to bypass the Torqloc, disconnect the Blue and Yellow Torqloc wires from the factory TCC wire which was cut to install the Torqloc & reconnect the factory wires back together.

After final wiring and testing has been done on the vehicle, mark the label on the module for the application (vehicle and kit part number). Secure module to a harness or bracket under dash with tie wraps.

Wiring The TORQLOC (without an exhaust brake)

This includes *Jacobs E-Brake* for Dodge ISB and *US Gear D-Celerator* exhaust brakes:

For those applications where there is no exhaust brake installed, or, where the automatic feature of the **TorqLoc** module is not desired or cannot be installed, follow the same wiring instructions as in the previous pages, except remove the long section of **Brown** wire on the 3-Pos. switch that is mentioned in the **BPS section** and ignore the chart of where to hook up that long section of **Brown** wire.

The short section of **Brown** wire mentioned in the BPS section is still to be connected to the BPS terminal on the module. **NOTE:** The **Down/Green** light and the **Mid/White** light positions on the 3-position switch now serve no function. The **Up/Red** light position is the only one that has a function, which is to manually keep the convertor lock-up clutch engaged.

Testing the TORQLOC (without an exhaust brake)

With the module pulled out enough to be easily visible while driving, take the vehicle for a drive. Turn the brake on and first check that the LED light comes on once the vehicle has surpassed the set speed. On some Ford trucks the LED will only come on above the set speed when the throttle is returned to idle. If the LED fails to illuminate after the set speed, check the dip-switch settings, the VSS wire color and the connection to that wire, the wire is on the right terminal at the module, and make sure there is a good power source and ground for the module.

Cruise at a constant speed above the set speed of the module, turn **TorqLoc** switch on to the **Up (Red)** position and let off the throttle. The lock-up should stay engaged. Turn **TorqLoc** switch on to the **Middle (White)** position and lock-up clutch should disengage. Cruise again at a constant speed and turn **TorqLoc** switch on to the **Up (Red)** position, then let off the throttle and let the vehicle slow down below the set speed, making sure the lock-up disengages once below the set speed. If these situations fail to occur, check the wiring to module, and check terminal locations on the module.

On Dodges, after starting up the truck and starting drive, the O/D off light should have illuminated (if that option was hooked up). With the brake turned on, drive until overdrive is reached then let off the throttle. With the brake and lock-up clutch engaged, push the overdrive button to check that the lock-up clutch disengages and the transmission shifts out of overdrive. If this fails to occur, check the O/D wire color and connection to that wire and the wire in on the right terminal at the module. If any of the functions still fail to occur, phone our technical service department for further assistance. If it is necessary to bypass the Torqloc, disconnect the Blue and Yellow Torqloc wires from the factory TCC wire which was cut to install the Torqloc & reconnect the factory wires back together.

BD Engine Brake Inc.

Plant Address: 33541 MacLure Rd. Abbotsford, BC, Canada V2S 7W2

U.S. Shipping Address: 88-446 Harrison St, Sumas, WA 98295 U.S. Mailing Address: P.O. Box 231, Sumas, WA 98295

Phone: 604-853-6096 | Fax: 604-853-8749 | Internet: www.bd-power.com

Note that if you have installed the unit on a Ford and you have a higher autoloc unlock speed in overdrive than in drive, you most likely have a coast clutch problem in the transmission. A BD Pressureloc can help to prevent this.

After final wiring and testing has been done on the vehicle, mark the label on the module for the application (vehicle and kit part number). Secure module to a harness or bracket under dash with tie wraps.

Dodge "TRANS" Relay Bypass (1996-2000)

Remove the cover on the Power Distribution Center (PDC) box, behind the driver's side battery. Replace the "TRANS" relay (see diagrams below, or bottom of PDC cover) with Copper Jumper.

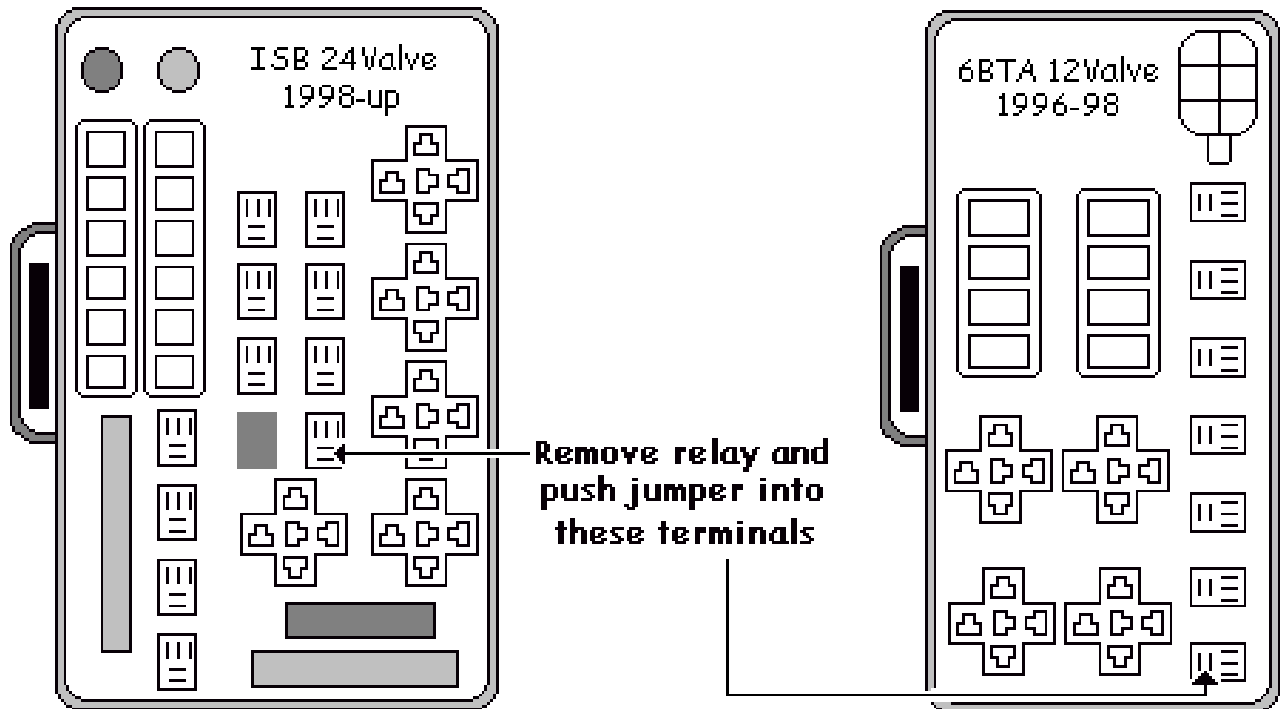

This is not required on 1999-up California model trucks.

Some trucks may set various transmission codes once the Torqloc is installed. If the Engine Service Light comes on after operation, try reinstalling the relay, then clear the fault code from the ECM.

2001-up: These vehicles USUALLY do not require the relay to be removed and have the jumper wire installed. Please test the installation with the factory relay installed. If any symptoms occur, remove the relay and install the jumper wire.

BD TORQLOC WIRING DIAGRAMS -

- BD BRAKES: 1995-2003 FORD 7.3L / 1999-2005 DODGE 24V

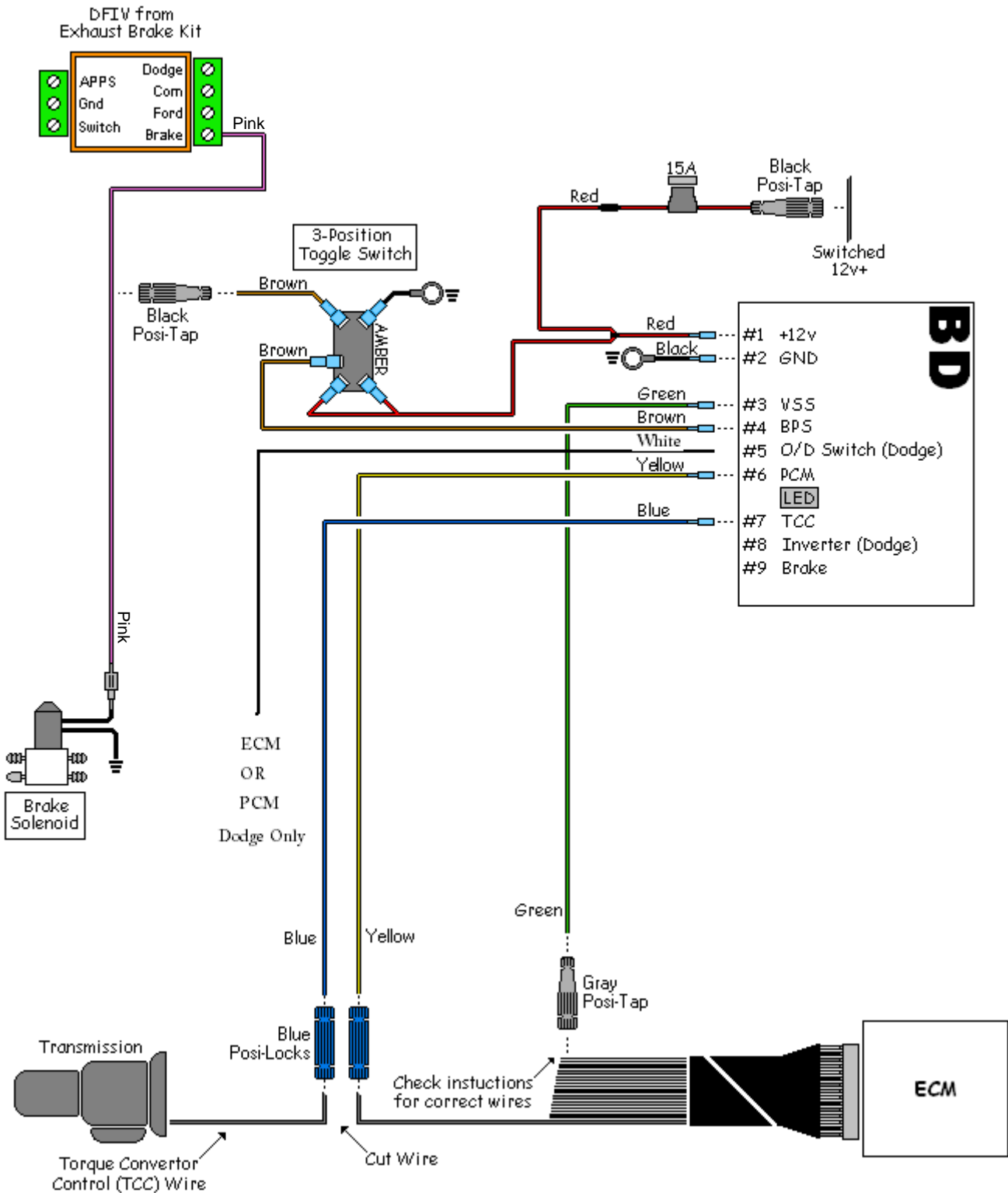

BD TORQLOC WIRING DIAGRAMS -

- **BD BRAKES: 1994-1998 DODGE / 1988-94 FORD IDI / CHEVY 6.2-6.5L**
- **PAC BRAKE: DODGE 12V**

NOTE: CHEVY TRUCKS WITH A 6.2/6.5L ENGINE MUST HAVE A LOCK UP TRANSMISSION (ie. 4L60E/4L80E) IN ORDER TO USE THIS SYSTEM.

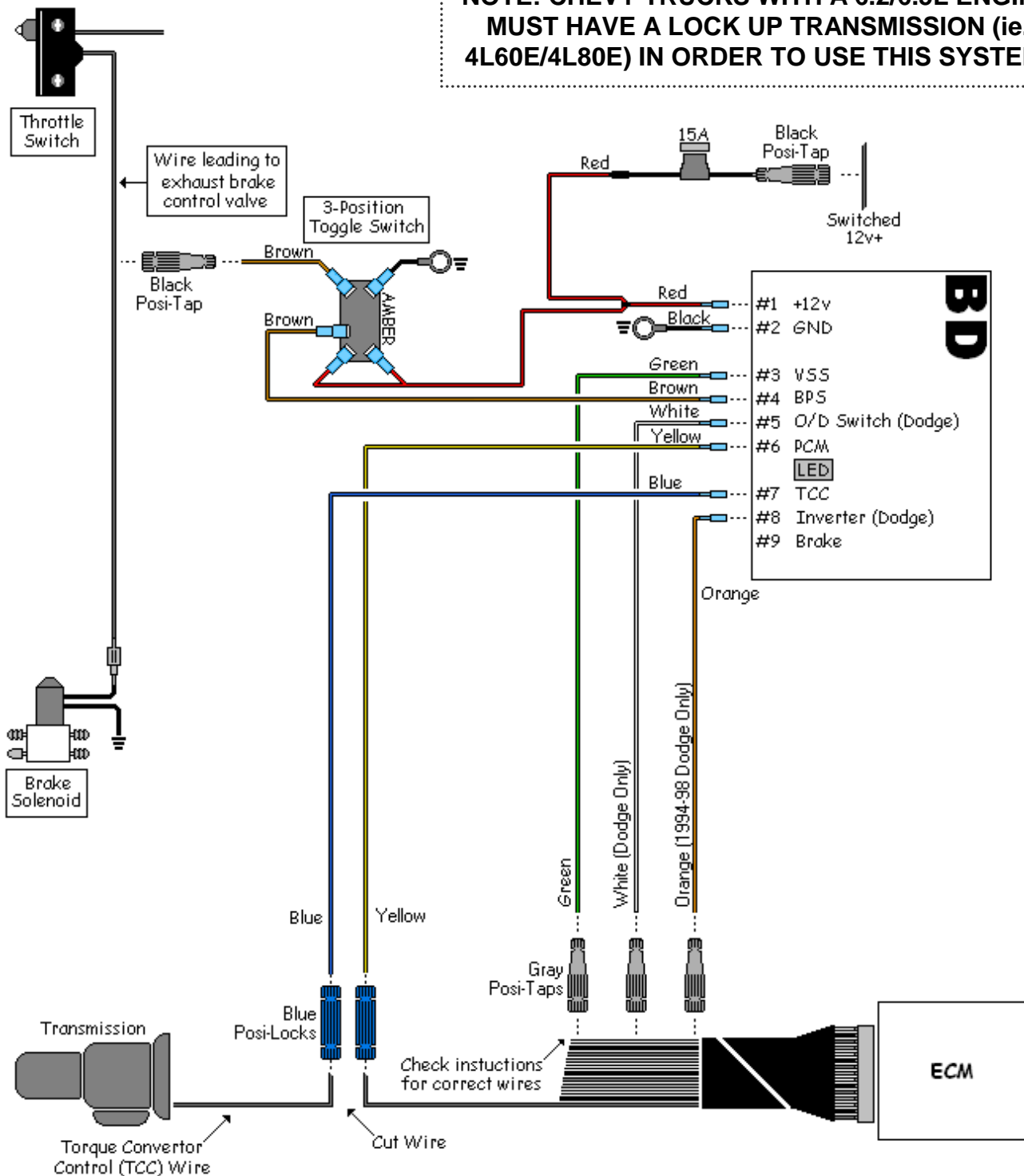

BD TORQLOC WIRING DIAGRAMS - - PAC BRAKE: 1995-97 FORD POWERSTROKE

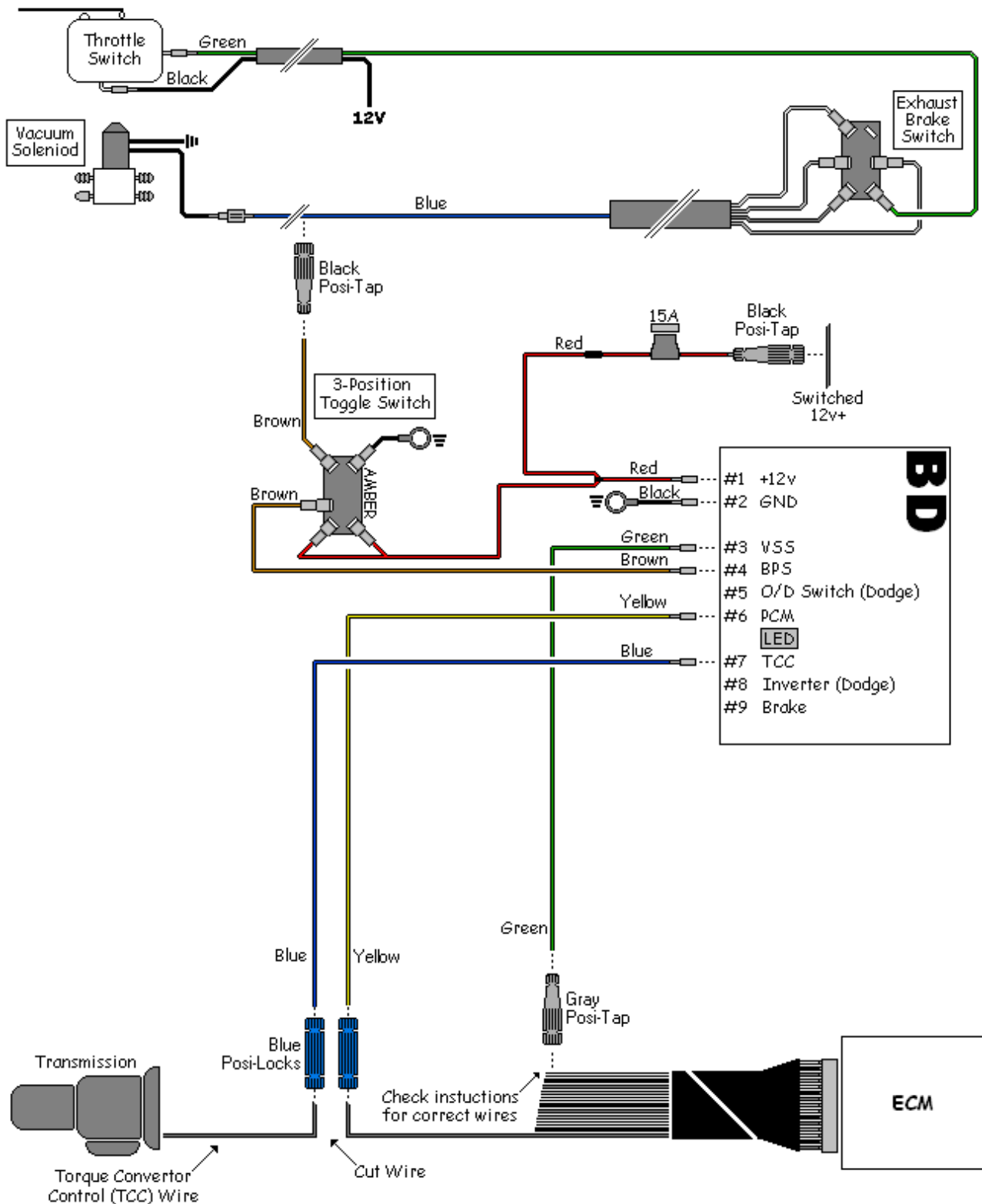

BD TORQLOC WIRING DIAGRAMS -

· JACOBS E-BRAKE: DODGE 12 Valve

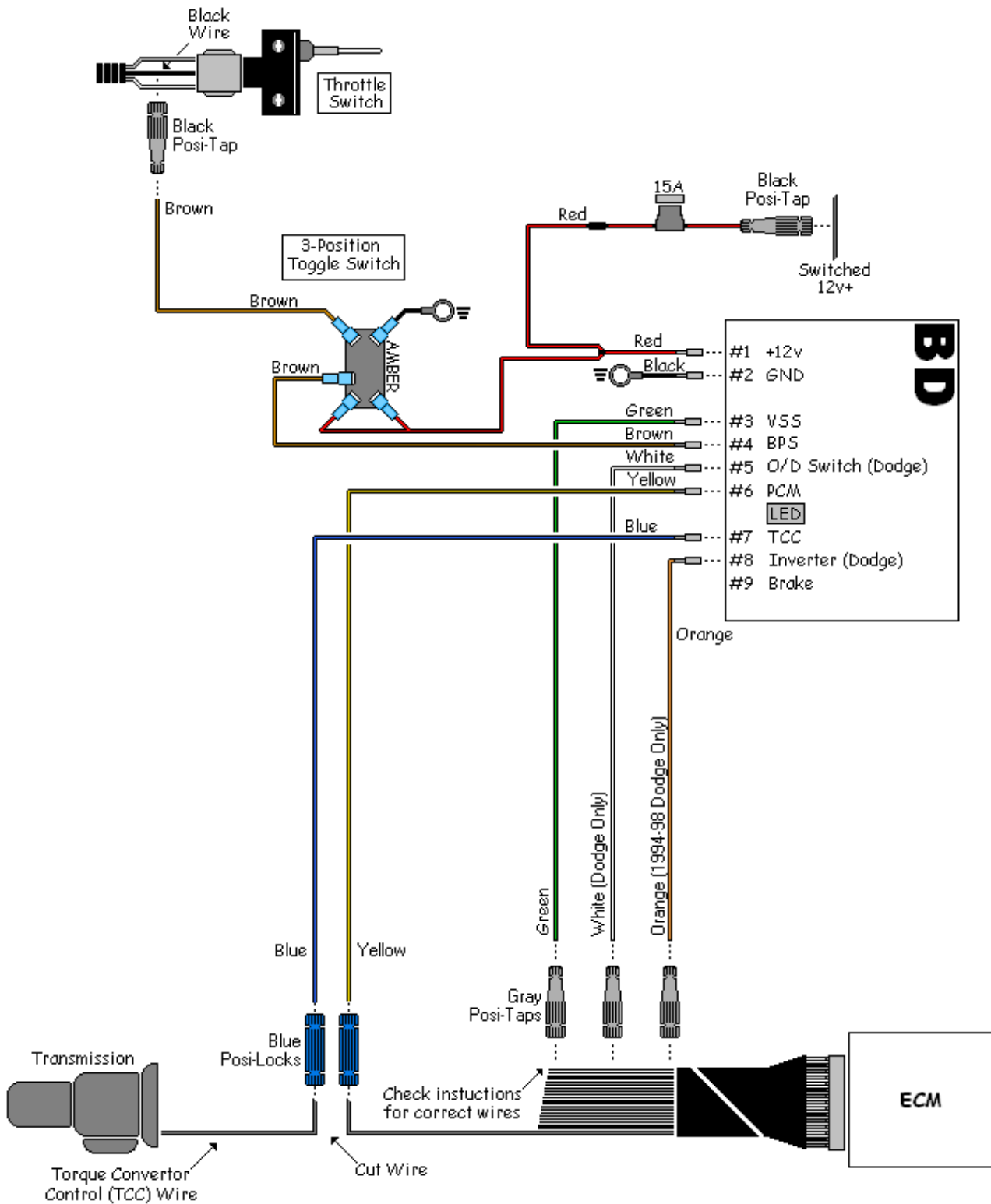

BD TORQLOC WIRING DIAGRAMS -

- PAC BRAKE: DODGE ISB 24 VALVES
- JACOBS BRAKE: DODGE ISB 24 VALVES
- US GEAR D-CELERATOR BRAKES
- NO EXHAUST BRAKE INSTALLED

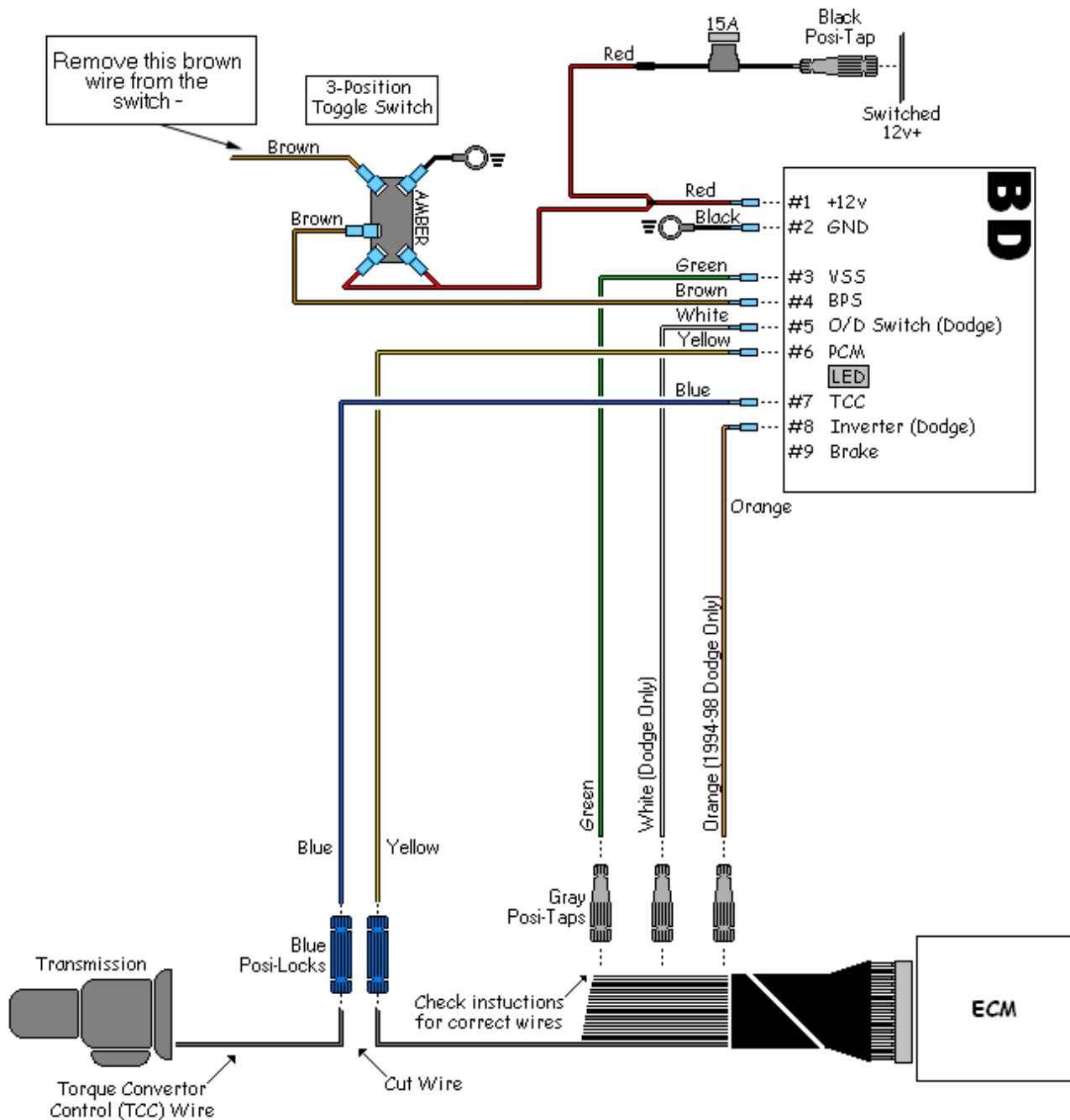

AUTOLOC vs. TORQLOC

The difference between the AutoLoc and **TorqLoc** is that the AutoLoc automatically controls the TCC lock up signal once it receives a power signal from the exhaust brake switch and the **TorqLoc** has a manual position, automatic (or AutoLoc position), and an Off position.

So, in comparing between the AutoLoc and the **TorqLoc**, the **TorqLoc** will force the convertor clutch to lock up & the AutoLoc will only hold an already locked up convertor clutch. When you ask for an overdrive to third gear shift, the **TorqLoc** doesn't wait for the computer to lock up the clutch, it sends its own signal to the convertor clutch, and as long as you are A) above the set speed and B) the transmission is hydraulically correct, [throttle pressure is applied], the **TorqLoc** will force a lock up.

The AutoLoc cannot force a lock up, but can only hold it on deceleration. The Chrysler transmission does not lock up in third gear, unless the overdrive is turned off. Also, the Chrysler transmission won't allow an overdrive to third gear downshift if the TC clutch is locked up. This holds true no matter what system you are using to hold the TC locked up.

While driving with the overdrive turned off, and the AutoLoc is turned on, the transmission shifts from first to second to third, and then locks up.

Anytime after the lock up has occurred and you take your foot off the accelerator, the AutoLoc will turn the exhaust brake on and hold the torque convertor clutch locked until about 25mph when it will then turn off the torque convertor clutch. When driving on the freeway in overdrive, the torque convertor clutch will be locked up and the AutoLoc turned on, if you release the throttle the AutoLoc will apply the brake and hold the TC clutch lock up.

To increase the amount of retarding horsepower, turn off the overdrive and the AutoLoc will sense this signal and cut the signal that's holding the torque convertor clutch applied, the transmission will then downshift into third gear. At this point you should apply throttle pressure until the factory computer says everything is okay and locks up the torque convertor clutch.

As soon as this happens you should remove throttle pressure and the AutoLoc will turn the exhaust brake on and keep the torque convertor clutch applied until you get down to about the 25mph mark. The set speed is adjustable, one can set it for a higher mph, so you don't have to worry about remembering to turn off the overdrive or lower if one has 4:10 gears.

Now suppose you're driving along, overdrive is on, the AutoLoc is on and you need to make a stop or slow down, but don't need the extra retarding horsepower of third gear or you don't have time to wait for the downshift, applying throttle and waiting for lockup, (this would all take about 4-6 seconds) and you don't want the

shuddering that would occur when you have a locked up torque convertor clutch & you're going to be doing less than 35 mph in overdrive.

You can do any of the four following actions to cancel out the system: 1) turn off the AutoLoc switch, 2) turn off the overdrive, 3) lightly step on the throttle pedal, or 4) pull the gearshift lever down into second gear. Turning off the overdrive or the AutoLoc are the best of the four options.

Now enters the **TorqLoc**, it should only be used under light throttle applications. No matter whose torque convertor you are using, the converter clutch has only so much holding power & if you exceed this you will start to slip the clutch, thereby starting the demise of your convertor clutch.

An example of when to use the **TorqLoc** position would be when you are on a winding road where you are on and off the throttle a great deal and you don't want to keep locking and unlocking the convertor clutch. The **TorqLoc** will hold the convertor clutch locked up, preventing that from happening.

You must keep in mind, while doing this, that if you apply too much throttle pressure, especially at the lower rpm band, you may start to slip the convertor clutch. A general rule of thumb when holding the convertor clutch locked up is no more than 1 lb of boost for every 100 rpm of engine speed.

Questions?

If you required technical assistance with the installation or operation of this kit, please contact us at **604-853-6096**, Monday to Friday, 8:00am to 5:00 Pacific Time.