



**DOWNLOAD ENHANCED
INSTALL MANUALS AT
*dieselperformance.com***



BD AutoLoc

Torque Converter Control System

Part# 1030390

Installation Manual for the following applications:

BD Brakes for Dodge, Ford and Chevrolet

Pac Brake for Dodge & Ford

Jacobs E-Brake for 1994-98 Dodge 6BTA 12 Valve

*** Please read this instruction manual before starting installation ***

BD Engine Brake Inc.

Plant Address: 33541 MacLure Rd. Abbotsford, BC, Canada V2S 7W2

U.S. Shipping Address: 88-446 Harrison St, Sumas, WA 98295 U.S. Mailing Address: P.O. Box 231, Sumas, WA 98295

Phone: 604-853-6096 | Fax: 604-853-8749 | Internet: www.bd-power.com

TABLE OF CONTENTS

Welcome 2

The BD AUTOLOC Advantage..... 2

Operating the BD AUTOLOC 3

Transmission Quirks 4

Compatibility With Other Exhaust Brake Brands..... 4

Adjusting For Your Application 5

Wiring And Plumbing..... 7

Wire Connections..... 10

1994-95 Dodge Pinouts..... 10

1996-03 Dodge Pinouts..... 10

2004 / 05 Dodge Pinouts..... 11

Ford Pinouts 11

Testing The AUTOLOC..... 12

Dodge "TRANS" Relay Bypass (1996-2000)..... 13

BD AUTOLOC WIRING DIAGRAMS 14

- BD BRAKES: 1999-2005 DODGE 24V 14
- BD BRAKES: 1994-1998 DODGE / 1988-94 FORD IDI / CHEVY 6.2-6.5L* 16
- PAC BRAKE: DODGE 12V..... 16
- PAC BRAKE: 1995-97 FORD POWERSTROKE 17
- JACOBS E-BRAKE: DODGE 12 Valve 18

AUTOLOC vs. TORQLOC 19

Questions? 20

Welcome

Thank you for purchasing the BD **AutoLoc** Kit. This manual is to aid you with your installation and operation of the unit. We strongly suggest that you retain this manual for any future reference.

NOTE: This kit cannot be installed on the Jacobs E-Brake system for the Dodge ISB 24 valve application. Also, for all US Gear D-Celerator exhaust brakes, you must use the 1030395 TorqLoc kit.

The BD AUTOLOC Advantage

Currently, exhaust brake usage can cause high temperatures in the automatic transmission due to torque convertor slippage. Only 10% to 80% of the retarding force is transferred through the fluid coupling of most torque convertors.

The **BD AutoLoc** commands the lock-up clutch of the torque convertor to stay engaged when the **BD Exhaust Brake** is activated. This allows up to 100% of the retarding force to be transferred while in 3rd and 4th gear. Also, transmission oil temperatures will remain low because of little or no slippage occurring in the convertor in these gears.

Operating the BD AUTOLOC

The **AutoLoc** works off of the power signal from throttle or toggle switch of the exhaust brake that activates the valve to close, and, will only take effect when the vehicle is above a set speed (approximately 25 to 30 mph), the exhaust brake is activated and the torque convertor lock-up clutch is engaged.

For all applications with the exception of the **BD Exhaust Brake** on the **Ford PowerStroke**, this kit does not control the exhaust brake, it only utilizes the exhaust brake power signals to activate the control of the lock-up clutch. With the **BD Exhaust Brake** on the **Ford PowerStroke**, the unit controls the activation of the brake, which will shut the brake off once the vehicle speed drops below the set speed.

The lock-up clutch usually engages when the vehicle is cruising, with little throttle action. On most vehicles, the lock-up clutch will be engaged when applying pressure to the accelerator pedal until lock-up engages, then lift foot off of the accelerator.

Accelerator pedal pressure is also required after shifting out of or into overdrive to reengage the lock-up. The **AutoLoc** is programmed to disengage the lock-up clutch once the vehicle drops below the set speed.

For proper operation of the **Dodge** transmission, the lock-up clutch must be disengaged before the transmission will shift out of overdrive and into 3rd gear. The **AutoLoc** module compensates for this by disengaging the lock-up clutch when the "O/D" button is activated to turn the overdrive off while the exhaust brake is turned on. To reactivate the lock-up, apply pressure to the accelerator pedal until lock-up engages, then lift foot off of the accelerator pedal.

On all vehicles, the transmission should be shifted out of overdrive if speed drops below 40mph. Otherwise there could be a transmission shudder as the vehicle's speed continues to drop until it reaches the set speed that the **AutoLoc** unit will disengage the lock-up.

IMPORTANT: With **Dodge** trucks, the module has an Overdrive inverter option that will disengage the Overdrive when the truck starts to move after being started up.

This will prevent possible transmission shutter on trucks with raised horsepower, and, will allow for the transmission to lock-up the clutch in third gear before reaching overdrive when starting to up-shift from a dead stop, allowing cooler fluid temperatures when driving at "city" speeds. This is an option and does not need to be connected for proper operation of the **AutoLoc** module; ignore all references to the "Inverter" if this option is not desired.

Note: The OD inverter is not compatible with 2005 Dodges. A BD Overdrive Cutout PN 1031350 may be purchased separately to control OD on a 2005 Dodge.

BD Engine Brake Inc.

Plant Address: 33541 MacLure Rd. Abbotsford, BC, Canada V2S 7W2

U.S. Shipping Address: 88-446 Harrison St, Sumas, WA 98295 U.S. Mailing Address: P.O. Box 231, Sumas, WA 98295

Phone: 604-853-6096 | Fax: 604-853-8749 | Internet: www.bd-power.com

Transmission Quirks

Some Dodge trucks built between the production dates of 09/1995 to 04/1996 have had computers that the programming for the transmission control has caused some lock-up control problems and/or will cause the **AutoLoc** not to operate correctly. If this occurs, the computer can be "re-flashed" to current specifications at most Dodge dealerships. Sometimes this can be done under warranty, but labor charges may apply (usually 1/2 hour).

Some Dodges that are of the 1999-2002 model years and of California specifications may require the transmission relay to be re-installed back into its socket, which would have been removed in the "1996-2002 Dodge "TRANS" Relay Bypass" section of this manual.

Note that if you have installed the unit on a Ford and you have a higher autoloc unlock speed in overdrive then drive, you most likely have a coast clutch problem in the transmission. A BD Pressureloc can help to prevent this.

Other items installed that may affect the operation of the transmission may have an effect on the operation of the **AutoLoc** (i.e. auxiliary transmissions). Please make this known if contacting the BD Technical Service Department.

Compatibility With Other Exhaust Brake Brands

Most of the provided diagrams, instructions and parts relate to the installation and operation of this unit in conjunction with a BD Exhaust Brake. In this manual, we have provided some diagrams and additional instructions for some of the other systems that we have had access to their diagrams.

An installation in conjunction with any other system should only be done with instruction from one of our BD Technicians, with wiring diagrams and/or schematics provided to them. Additional lead-time, parts and/or labor may be required. Though we try to give all the information and instruction we can, to install the **AutoLoc** on non-BD systems, we may have not thoroughly investigated these systems at our factory, which may also lead to additional labor and/or parts, or even removal of the **AutoLoc**.

NOTE - Pac Brake exhaust brakes only: If the truck has a 6BTA 12 valve engine with 60lb springs, remove the Pac Brake valve and drill out the pressure relief hole from 9/23" to 31/64". This modification is not required in 24 Valve or newer trucks.

Adjusting For Your Application

Before starting the installation, open the control box up by removing two screws on bottom of module. On the opposite end of the circuit board from the terminals, there is a selection of 8 "dip" switches. The dip switches control the speed that the **AutoLoc** module will disconnect the lock-up clutch. We have provided settings for the module to disconnect the lock-up at approximately 25mph to 30mph. If you find that the set speed is too high or low for the vehicle, phone our technical service department for alternative settings.

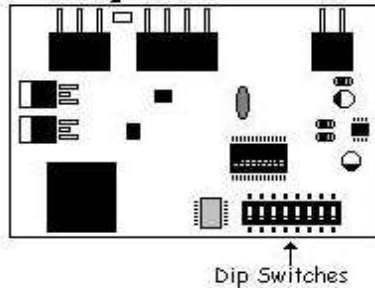

Chevy

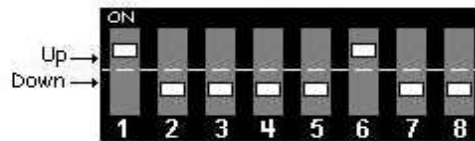

Dodge & Ford

4:10 Ratio

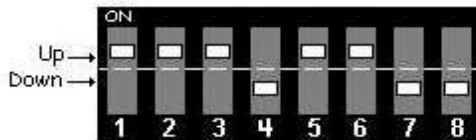











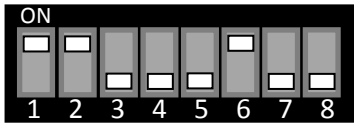

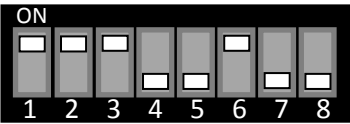

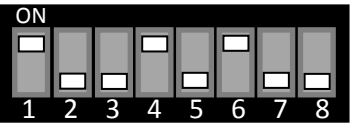







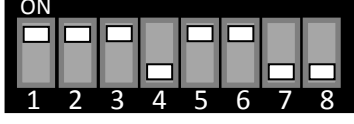





3:55 & 3:73 Ratios

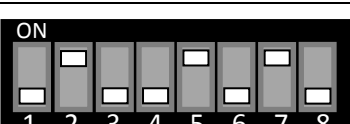

NOTE: To insure proper function of the dip switches, flip each dip switch back and forth once before setting them, even if the dip switches are already set for the application it's being installed on.

The "LED" (Light Emitting Diode) on the circuit board will show a Red light when the **AutoLoc** is functioning. Once the unit is installed, test drive the vehicle to make sure the light comes on and then turns off at the set speed.

Additional Dodge/Ford DIP Switch Settings

	4.10 GEARS	3.73 GEARS	3.55 GEARS
20MPH	Up  Down 	Up  Down 	Up  Down 
25MPH	Up  Down 	Up  Down 	Up  Down 
30MPH	Up  Down 	Up  Down 	Up  Down 
35MPH	Up  Down 	Up  Down 	Up  Down 
40MPH	Up  Down 	Up  Down 	Up  Down 

BD Engine Brake Inc.

Plant Address: 33541 MacLure Rd. Abbotsford, BC, Canada V2S 7W2

U.S. Shipping Address: 88-446 Harrison St, Sumas, WA 98295 U.S. Mailing Address: P.O. Box 231, Sumas, WA 98295

Phone: 604-853-6096 | Fax: 604-853-8749 | Internet: www.bd-power.com

Wiring

Disconnect the ground (Negative) terminals on all vehicle batteries before starting installation. The following instructions are divided per wire going up to each individual terminal labeled on the **AutoLoc** module, and the terminals in these instructions will be numbered starting from the top at the +12V terminal. Follow along with the diagrams following the written instructions for ease of installation.

After wiring, additional instructions will follow for 1996-up Dodges. For 1999-03 Ford PowerStrokes, remove the driver's side front fender well for access to computer harness. When possible, check for continuity through all Posi-Tap™ connectors after you have installed them. We suggest soldering and shrink tubing all connections, but we also provide Posi-Taps™ for your convenience.

+12V	#1	AutoLoc power lead (Red wire)
Using a test light or multi-meter, find a key switched +12 Volt power source in the wiring harness under the dash. Connect the Red wire to it using a black Posi-Tap™ and connect the other end of the Red wire to the +12v terminal on the module.		
GND	#2	AutoLoc ground (Black wire)
Connect to any bolt/screw under the dash that is a good ground.		

VSS	#3	Vehicle Speed Sensor (Green wire)
Locate the VSS (Vehicle Speed Sensor) wire in the vehicles computer wiring harness (see chart). Run the AutoLoc Green wire to the VSS wire and cut off any excess, leaving some slack. Connect to the VSS wire using a gray Posi-Tap™, or, solder the Green wire to the VSS wire and protect it from the elements (i.e. liquid electrical tape).		
DODGE (5.9L)	2004-2005	Pin 11 at ECM C2 50 pin (Dark Green w/Yellow tracer)
	1996-2003	Pin 27 at PCM (White w/Orange Tracer)
	1994-1995	Pin 47 on PCM (White w/Orange Tracer)
FORD (7.3L)	1995-2003	Pin 58 at ECM (Gray w/Black Tracer)
	1990-1994	Pin 3 at ECM (Gray w/Black Tracer)
CHEVY (6.5L)	1994-2000	Pin 15 (Dark Green w/White Tracer) at VSS Buffer beside the ECM (Behind glove box)
	1992-1993	Light Blue w/Black Tracer at VSS Buffer by ECM

BPS	#4	Brake Power Signal (<i>Brown Wire</i>)
<p>The module is looking for the 12-volt positive signal that triggers the exhaust brake to activate. Use the chart below and wiring diagrams at the back of this manual to make the correct correction.</p>		
Brake System		Connection
<p>BD Brake (<i>except Ford PowerStroke</i>) & Pac Brake (<i>Dodge Application</i>)</p>		<p>Posi-Tap™ onto the wire leading from the throttle switch / DFIV brake activation wire going to the exhaust brake.</p>
<p>BD Brake (<i>Ford PowerStroke</i>)</p>		<p>Connect the BPS (brown) wire to the DFIV brake output (pink) wire using the supplied positap™ (See “#9 Engine Brake” on the page 9 for the connection to the wire going to the Control Valve for the exhaust brake.)</p>
<p>Pac Brake (<i>1994-97 Ford PowerStroke</i>)</p>		<p>Posi-Tap™ onto the blue wire running from the toggle switch to the Vacuum Control Solenoid.</p>
<p>Jacobs E-Brake (<i>Dodge 6BTA</i>)</p>		<p>Posi-Tap™ onto the black wire on the wire harness at the throttle switch.</p>

O/D SW	#5	Dodge Overdrive Switch (<i>White wire</i>)
<p>For 1994-98 Dodges, locate the Lt. Green w/Orange Tracer wire, or, the Orange w/White on 1999-2003 Dodges, in the harness above the master brake cylinder (NOTE: The same harness that the VSS wire is usually found). For 2004 Dodges, locate the Dark Green wire at the ECM on the driver side of the engine (Pin 13 on the ECM C2 connector (50 pin)). 2005 Dodge trucks do not have an OD off wire and do not use this function.</p>		
<p>Cut the AutoLoc White wire to length, while leaving some slack. Connect to the overdrive wire using a gray Posi-Tap™ connector, or solder the White wire to O/D wire and protect from elements (i.e. liquid electrical tape)</p>		

PCM & TCC #6-7 Converter Control (Yellow #6 and Blue #7 wire)

Locate the vehicle’s Torque Converter Control (TCC) as described in the following chart. Cut the applicable wire and attach one end of a blue Posi-Lock connector to the wire leading back to the transmission, and attach one end of another blue Posi-Lock to the wire heading to the vehicles computer (ECM or PCM).

Connect the **AutoLoc Yellow** wire to the PCM (#6) terminal on the module then connect the **Blue** wire to the TCC (#7) terminal. Run the **Yellow** and **Blue** wire to the cut Converter Control wire and cut off any excess wire, leaving some slack. Attach the **Yellow** wire to the blue Posi-Lock that contains the wire that heads back to the vehicle’s computer. Attach the **Blue** wire to the other blue Posi-Lock that contains the wire heading back to the transmission. Instead of connectors, you could also solder the wires.

NOTE: Some vehicles have more than one wiring harness on transmission.

Make/Model	Year	Wire Color	Pin #	Location
DODGE (5.9L)	2004-2005	Y/LB	25	ECM 50 Pin Connection
	1996-2003	OR/BK	11	PCM C2
	1994-1995	OR/BK	54	PCM
FORD (7.3L)	1999-2003	VT/Y	54	PCM
	1995-1997	VT/Y	28	PCM
	1990-1994	VT/Y	53	PCM
CHEVY (6.5L)	1994-2000	Unplug harness from transmission then look inside plug and identify which wire is going to the “S” pin (usually Brown)		
	1992-1993	TAN/BK	“J” on Transmission	

INVERTER #8 Optional Overdrive Disable (Orange Wire)

For 1994-98 Dodges only, connect **Orange** wire to the Inverter terminal and run it to the same harness where the O/D Switch and VSS wire were found, cutting of excess and leaving some slack. Locate the Orange w/White Tracer and using a gray Posi-Tap™ connector or soldering, connect **Orange** wire to O/D wire.

For 1999-2002 Dodges, if the overdrive inverter option is desired, flip Dip Switch #8 to the “UP” position no matter what gear ratio you set the other switches to.

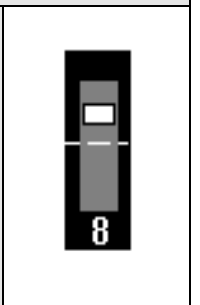

BRAKE	#9	BD Powerstroke Exhaust Brake Only (Orange Wire)
Using a Blue Butt connector, connect to the wire that leads to the Control Valve for the exhaust brake that was cut with hooking up the Brown wire in the “ BPS ” section on page 7.		

Wire Connections

1994-95 Dodge Pinouts

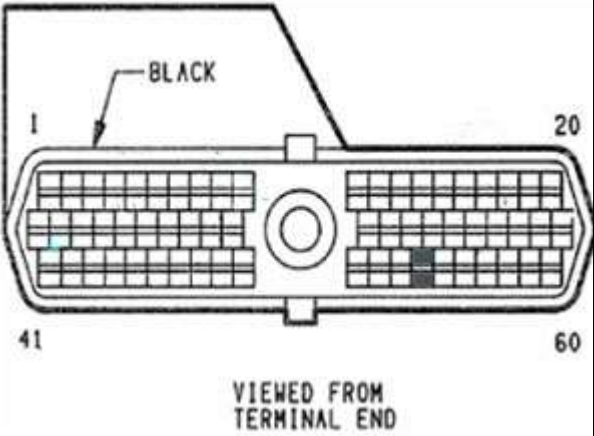
	Pin	Wire Color	Location
 <p style="text-align: center;">VIEWED FROM TERMINAL END</p>	54	OR/BK	PCM

1996-03 Dodge Pinouts

Pin	Wire	Location
11	OR/BK	PCM C2

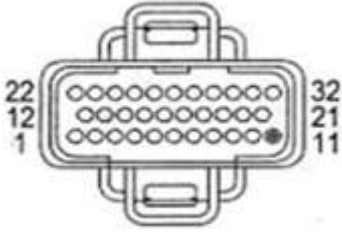

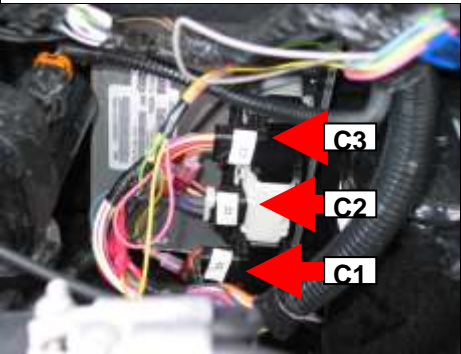



2004 / 05 Dodge Pinouts

Pin	Wire Colour	Location
25	Y/LB	ECM 50 PIN CONNECTION

KEY

- 1. Engine Control Module (ECM)
- 2. 60-Way Connector
- 3. 50-Way Connector

LOCATION OF DODGE CUMMINS ECM & HARNESSSES

Ford Pinouts

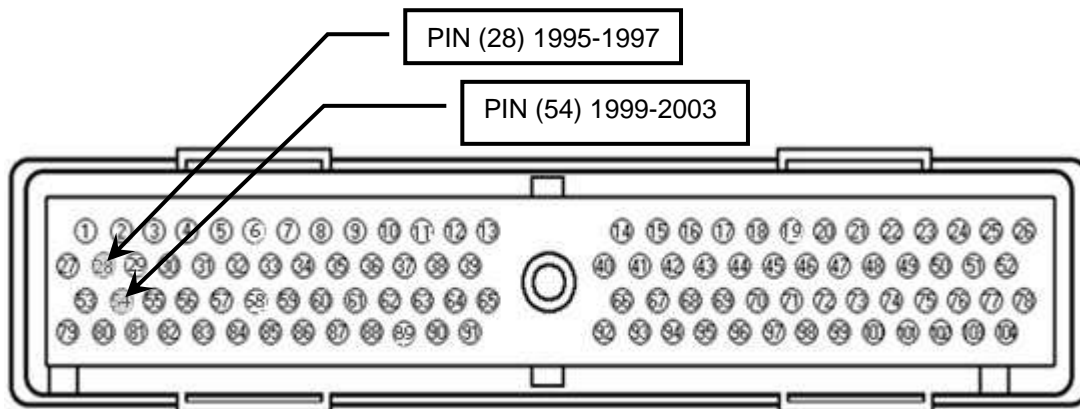

Pin	Year	Wire Colour	Location
54	1999-2003	VT/Y	PCM
28	1995-1997	VT/Y	PCM

Testing The AUTOLOC

NOTE: When wiring the **AutoLoc** module, leave enough slack on the wires so that the module can be pulled out enough to be easily visible during road tests, before finally securing the unit under the dash. Reconnect Ground terminals on batteries after installation and take the vehicle for a drive.

With no traffic around, cruise at a constant speed (higher than the set speed on the module) with the transmission “locked up”, then let off the throttle.

The brake should have activated and you should feel the hold back. Again, with the lock-up clutch engaged and while cruising, release the throttle pedal and check to see if the LED on the module is lit. If the LED fails to illuminate, check the dip switch settings, the VSS wire color and the connection to that wire. Check that the wire is on the right terminal at the module, and make sure there is a good power source and ground for the module.

Again, while cruising at a constant speed, let off the throttle and let the vehicle slow below the set speed, the lock-up should disengage (and BD Exhaust Brake on Ford PowerStroke application) below the set speed. If these situations fail to occur, then check the wiring to the brake and module, and, check terminal locations on the module.

On Dodges, after starting, the O/D off light should have illuminated (if that option was hooked up). Turn O/D on (light off) and the brake on, drive until overdrive is reached and lock-up has occurred then let off the throttle. With the brake and lock-up clutch engaged, push the overdrive button to check that the lock-up clutch disengages and the transmission shifts out of overdrive. If this fails to occur, check the O/D wire color and connection to that wire, and, the wiring on the terminals of the module.

Note that if you have installed the unit on a Ford and you have a higher autoloc unlock speed in overdrive then drive, you most likely have a coast clutch problem in the transmission. A BD Pressureloc can help to prevent this.

If any of the functions still fail to occur, phone our technical service department for further assistance. If it is required to bypass the effects of the module, unplug the Blue and Yellow wires at the transmission wire and plug the transmission wires together. After final wiring and testing has been done on the vehicle, mark the label on the module for the application (vehicle and kit part number). Secure module to a harness or bracket under dash with tie wraps.

BD Engine Brake Inc.

Plant Address: 33541 MacLure Rd. Abbotsford, BC, Canada V2S 7W2

U.S. Shipping Address: 88-446 Harrison St, Sumas, WA 98295 U.S. Mailing Address: P.O. Box 231, Sumas, WA 98295

Phone: 604-853-6096 | Fax: 604-853-8749 | Internet: www.bd-power.com

Dodge "TRANS" Relay Bypass (1996-2000)

Remove the cover on the Power Distribution Center (PDC) box, behind the driver's side battery. Replace the "TRANS" relay (see diagrams below, or bottom of PDC cover) with Copper Jumper.

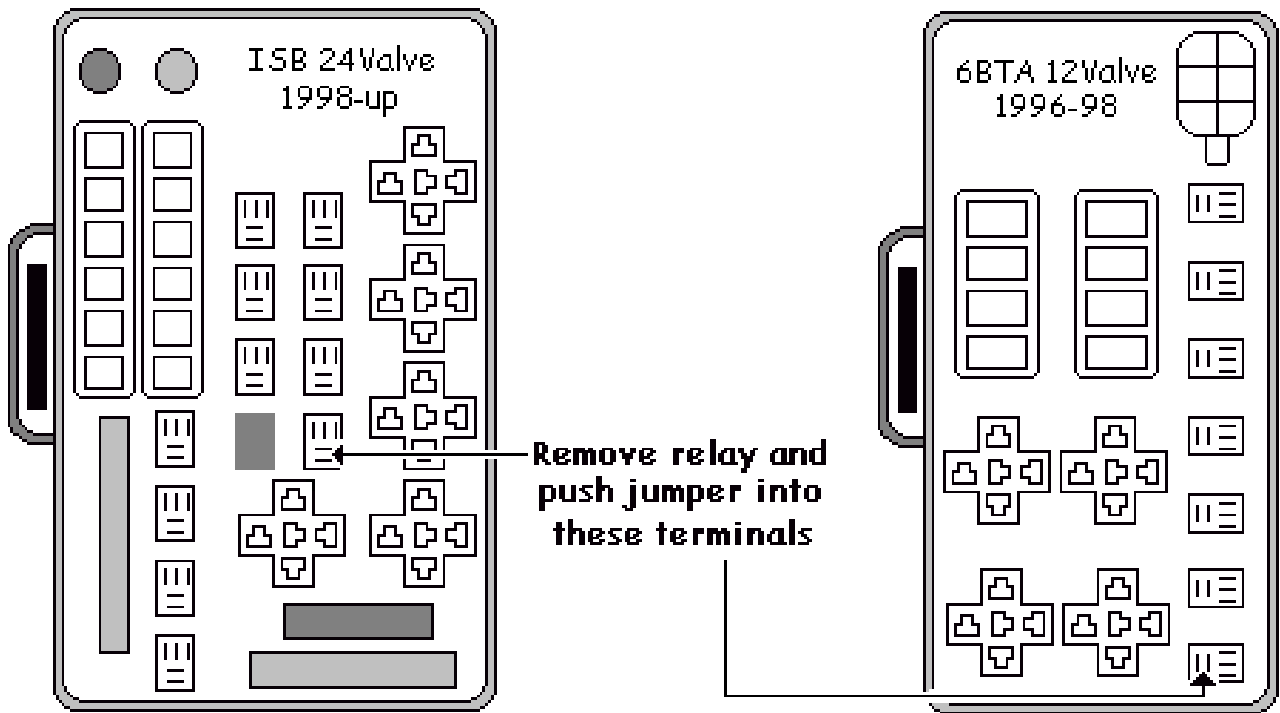

This is not required on 1999+ California model trucks.

If the Engine Service Light comes on after operation, try reinstalling the relay, then clear the fault code from the ECM.

2001-up: These vehicles USUALLY do not require the relay to be removed and having the jumper wire installed. Please test the installation with the factory relay installed. If any symptoms occur, remove the relay and install the jumper wire.

BD AUTOLOC WIRING DIAGRAMS

• BD BRAKES: 1999-2005 DODGE 24V

This diagram lets the system be controlled by the exhaust brake. Follow the instructions on the next page if you wish for the system to be controlled by the AutoLoc module.

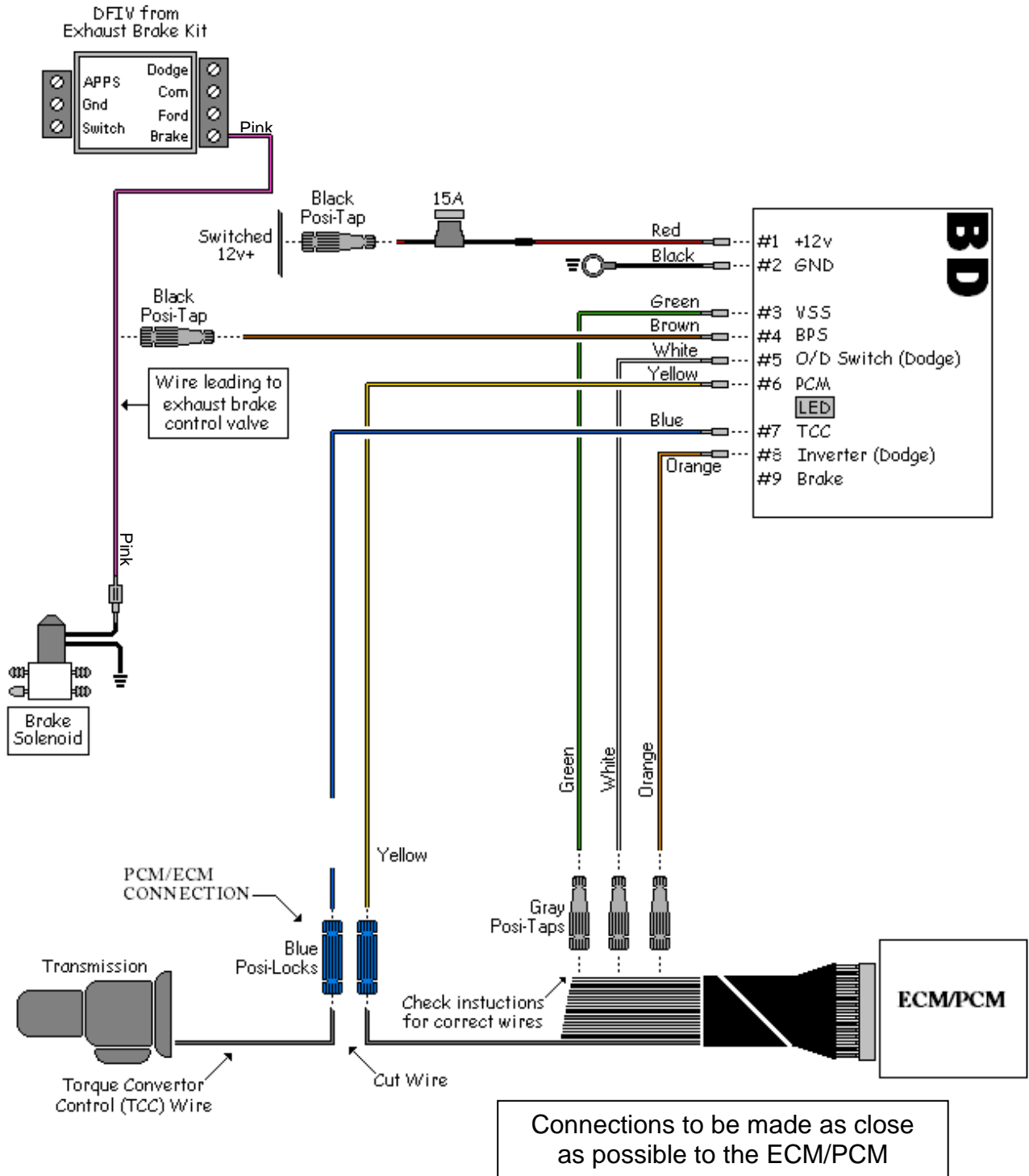

BD Engine Brake Inc.

Plant Address: 33541 MacLure Rd. Abbotsford, BC, Canada V2S 7W2

U.S. Shipping Address: 88-446 Harrison St, Sumas, WA 98295 U.S. Mailing Address: P.O. Box 231, Sumas, WA 98295

Phone: 604-853-6096 | Fax: 604-853-8749 | Internet: www.bd-power.com

BD AUTOLOC WIRING DIAGRAMS -

• BD BRAKES: 1995-2003 FORD POWERSTROKE 7.3L

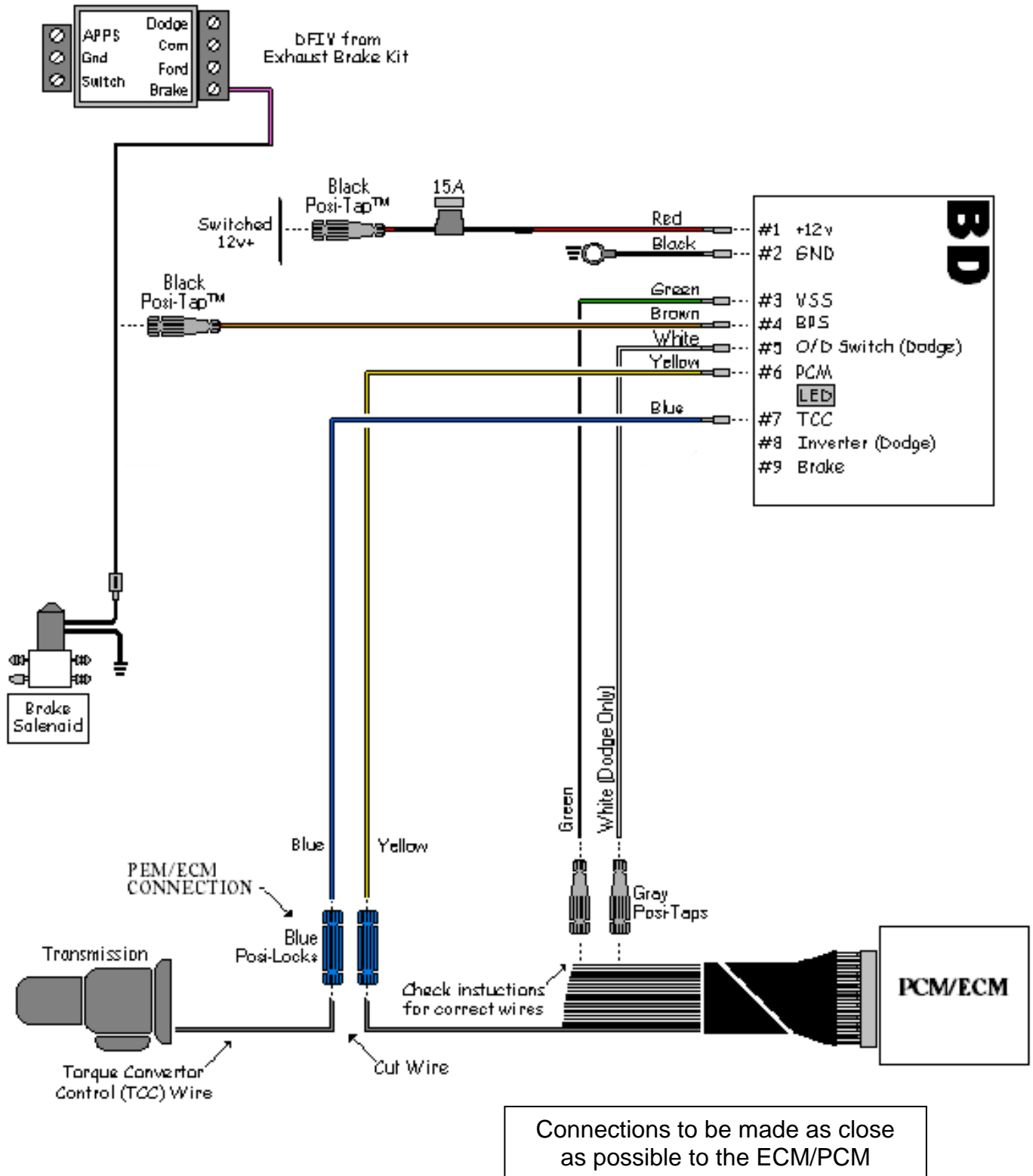

BD AUTOLOC WIRING DIAGRAMS -

- **BD BRAKES: 1994-1998 DODGE / 1988-94 FORD IDI / CHEVY 6.2-6.5L ***
- **PAC BRAKE: DODGE 12V**

*** NOTE: A 4L60E/4L80E transmission with lock-up capability is required in order to hook up an Auto/TorqLoc to a 6.2/6.5L Chevy truck.**

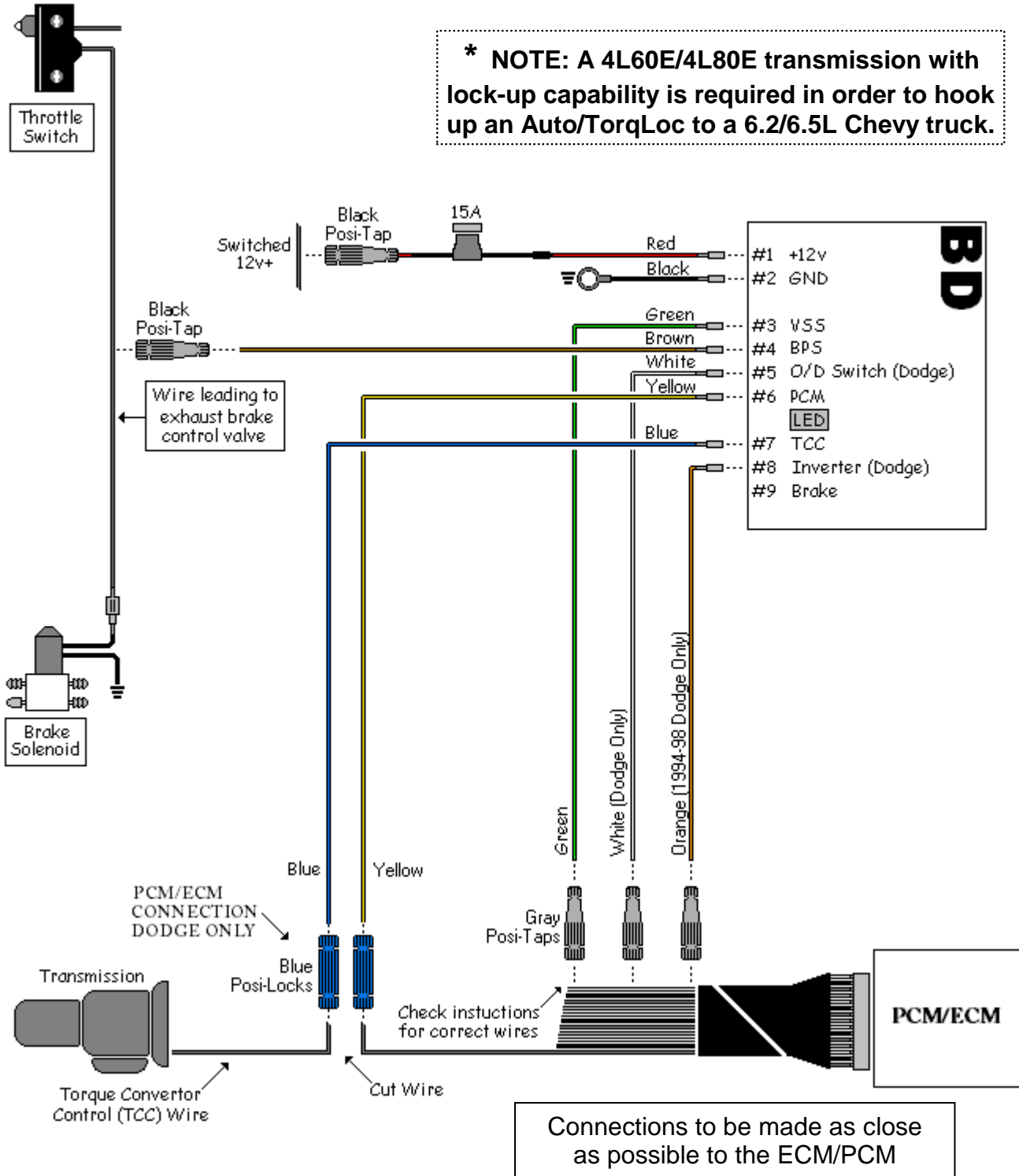

BD Engine Brake Inc.

Plant Address: 33541 MacLure Rd. Abbotsford, BC, Canada V2S 7W2

U.S. Shipping Address: 88-446 Harrison St, Sumas, WA 98295 U.S. Mailing Address: P.O. Box 231, Sumas, WA 98295

Phone: 604-853-6096 | Fax: 604-853-8749 | Internet: www.bd-power.com

BD AUTOLOC WIRING DIAGRAMS -

- PAC BRAKE: 1995-97 FORD POWERSTROKE

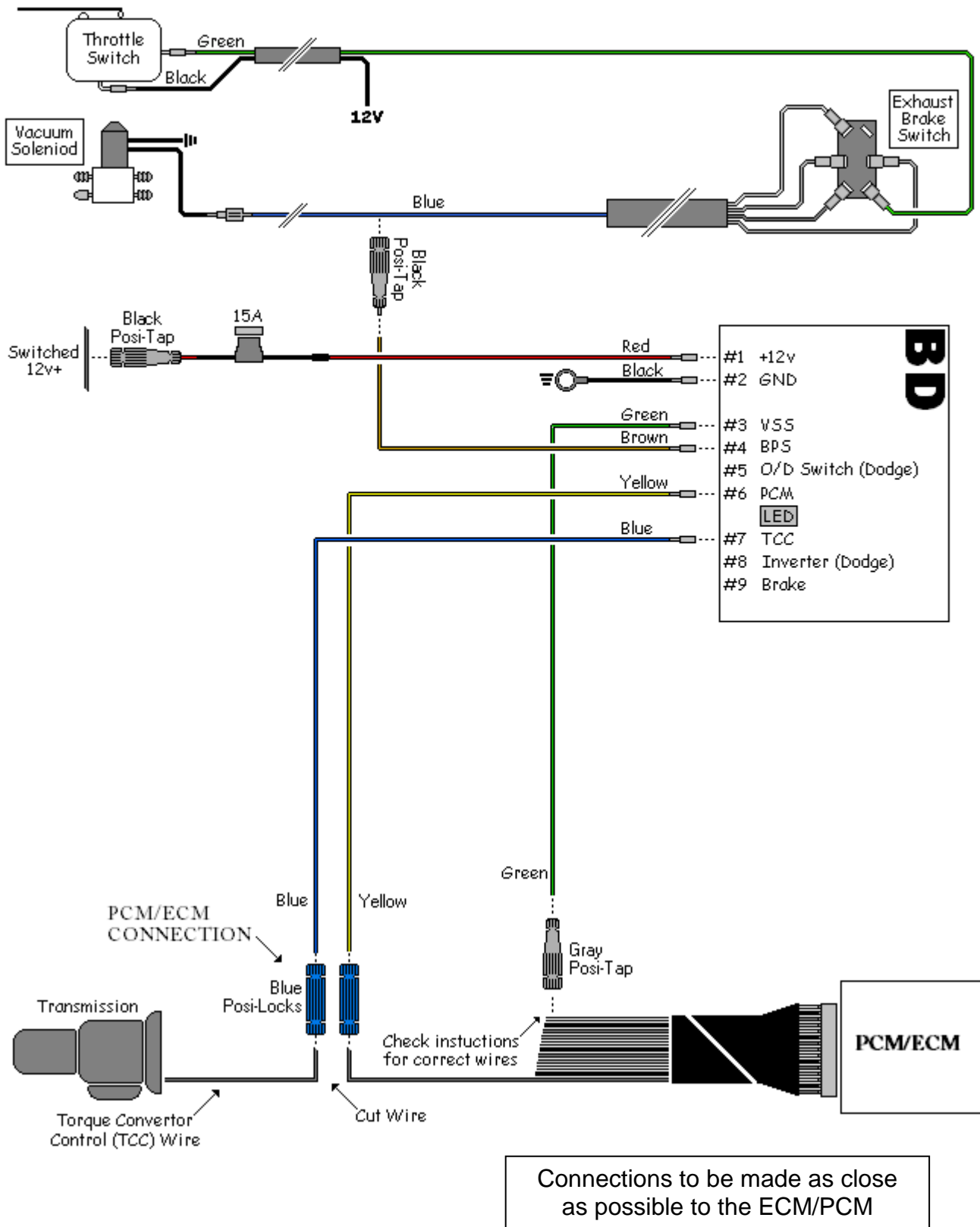

BD Engine Brake Inc.

Plant Address: 33541 MacLure Rd. Abbotsford, BC, Canada V2S 7W2

U.S. Shipping Address: 88-446 Harrison St, Sumas, WA 98295 U.S. Mailing Address: P.O. Box 231, Sumas, WA 98295

Phone: 604-853-6096 | Fax: 604-853-8749 | Internet: www.bd-power.com

BD AUTOLOC WIRING DIAGRAMS -

- JACOBS E-BRAKE: DODGE 12 Valve

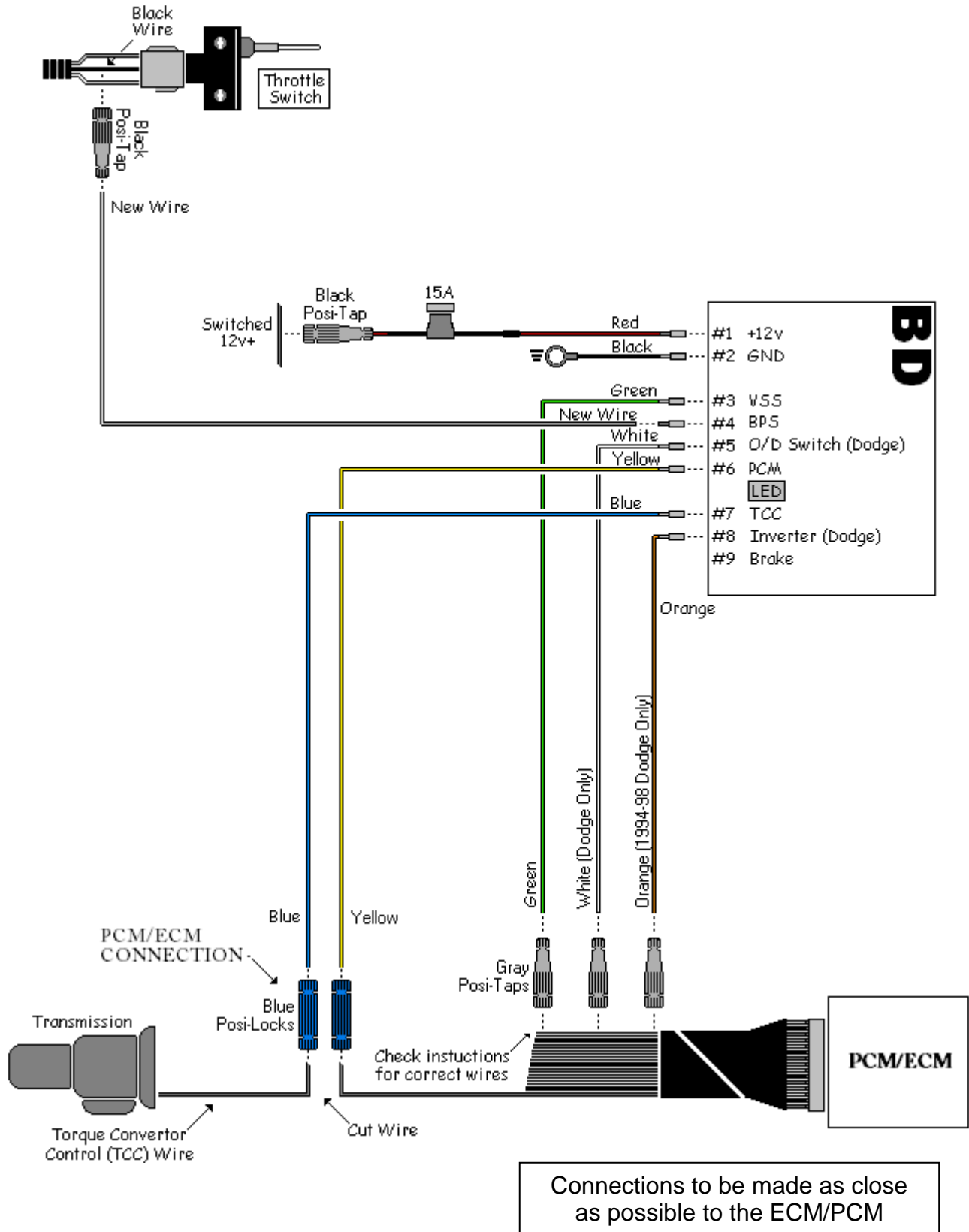

ATTENTION: DODGE ISB 24 VALVE engines with a Jacobs exhaust brake require a 1030395 TorqLoc kit. ** DO NOT USE A 1030390 AUTOLOC. **

AUTOLOC vs. TORQLOC

The difference between the AutoLoc and TorqLoc is that the AutoLoc automatically controls the TCC lock up signal once it receives a power signal from the exhaust brake switch and the TorqLoc has a manual position, automatic (or AutoLoc position), and an Off position.

So, in comparing between the AutoLoc and the TorqLoc, the TorqLoc will force the convertor clutch to lock up & the AutoLoc will only hold an already locked up convertor clutch. When you ask for an overdrive to third gear shift, the TorqLoc doesn't wait for the computer to lock up the clutch, it sends its own signal to the convertor clutch, and as long as you are A) above the set speed and B) the transmission is hydraulically correct, [throttle pressure is applied], the TorqLoc will force a lock up.

The AutoLoc cannot force a lock up, but can only hold it on deceleration. The Chrysler transmission does not lock up in third gear, unless the overdrive is turned off. Also, the Chrysler transmission won't allow an overdrive to third gear downshift if the TC clutch is locked up. This holds true not matter what system you are using to hold the TC locked up.

While driving with the overdrive turned off, and the AutoLoc is turned on, the transmission shifts from first to second to third, and then locks up.

Anytime after the lock up has occurred and you take your foot off the accelerator, the AutoLoc will turn the exhaust brake on and hold the torque convertor clutch locked until about 25mph when it will then turn off the torque convertor clutch. When driving on the freeway in overdrive, the torque convertor clutch will be locked up and the AutoLoc turned on, if you release the throttle the AutoLoc will apply the brake and hold the TC clutch lock up.

To increase the amount of retarding horsepower, turn off the overdrive and the AutoLoc will sense this signal and cut the signal that's holding the torque convertor clutch applied, the transmission will then downshift into third gear. At this point you should apply throttle pressure until the factory computer says everything is okay and locks up the torque convertor clutch.

As soon as this happens you should remove throttle pressure and the AutoLoc will turn the exhaust brake on and keep the torque convertor clutch applied until you get down to about the 25mph mark. The set speed is adjustable, one can set it for a higher mph, so you don't have to worry about remembering to turn off the overdrive or lower if one has 4:10 gears.

Now suppose you're driving along, overdrive is on, the AutoLoc is on and you need to make a stop or slow down, but don't need the extra retarding horsepower of third gear or you don't have time to wait for the downshift, applying throttle and waiting for lockup, (this would all take about 4-6 seconds) and you don't want the

shuddering that would occur when you have a locked up torque convertor clutch & you're going to be doing less than 35 mph in overdrive.

You can do any of the four following actions to cancel out the system: 1) turn off the AutoLoc switch, 2) turn off the overdrive, 3) lightly step on the throttle pedal, or 4) pull the gearshift lever down into second gear. Turning off the overdrive or the AutoLoc are the best of the four options.

Now enters the TorqLoc, it should only be used under light throttle applications. No matter whose torque convertor you are using, the converter clutch has only so much holding power & if you exceed this you will start to slip the clutch, thereby starting the demise of your convertor clutch.

An example of when to use the TorqLoc position would be when you are on a winding road where you are on and off the throttle a great deal and you don't want to keep locking and unlocking the convertor clutch. The TorqLoc will hold the convertor clutch locked up, preventing that from happening.

You must keep in mind, while doing this, that if you apply too much throttle pressure, especially at the lower rpm band, you may start to slip the convertor clutch. A general rule of thumb when holding the convertor clutch locked up is no more than 1 lb of boost for every 100 rpm of engine speed.

Questions?

If you required technical assistance with the installation or operation of this kit, please contact us at **604-853-6096**, Monday to Friday, 8:00am to 5:00 Pacific Time.

BD Engine Brake Inc.

Plant Address: 33541 MacLure Rd. Abbotsford, BC, Canada V2S 7W2

U.S. Shipping Address: 88-446 Harrison St, Sumas, WA 98295 U.S. Mailing Address: P.O. Box 231, Sumas, WA 98295

Phone: 604-853-6096 | Fax: 604-853-8749 | Internet: www.bd-power.com