



**DOWNLOAD ENHANCED
INSTALL MANUALS AT
*dieselperformance.com***



BD Adjustable Track Bar
2003-2012 Dodge Cummins
5.9L/6.7L (4WD Models)







P/N# 1032013-F

PLEASE READ ALL INSTRUCTIONS BEFORE INSTALLATION

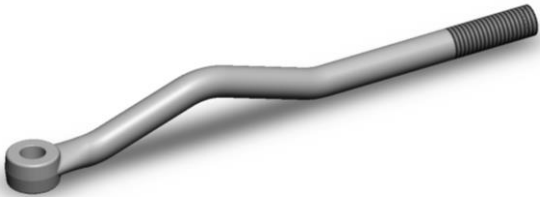
Length adjustment of the BD Track Bar is 39" -41" (bushing center to center)

KIT CONTENTS:

Please check to make sure that you have all the parts listed in this kit **before** you start the disassembly of your truck.

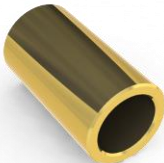
1302030-1F	1302030-2F	1302030-4
		
<i>Trackbar, Driver's Side</i>	<i>Trackbar, Passenger's Side (Left Hand Thread)</i>	<i>Threaded Connector</i>
Qty: 1	Qty: 1	Qty: 1
1302031	1302032	1302033
		
<i>Jam Nut 1 3/8NF</i>	<i>Jam Nut 1 3/8NF (Left Hand Thread)</i>	<i>Polyurethane Bushing Set</i>
Qty: 1	Qty: 1	Qty: 1
1302058 (Sleeves <u>NOT</u> used for 2003-07 vehicles)		
		
<i>16mm Sleeve</i>		
Qty: 2		

Welcome

Thank you for purchasing a BD track bar. This manual is divided into different areas to assist you with your installation and operation of your adjustable track bar.

This product is a replacement for the factory track bar. If the securing mounts have any signs of wear they should be fixed before installing the track bar. You will be reusing the factory bolts, if these bolts show any wear, replace them.

Installation should occur on a vehicle properly secured to prevent rolling.

Length adjustment of the BD Track Bar is 39" -41" (bushing center to center)

NOTE: Double check hardware before proceeding with installation.

Year	Bushing Size
2003-2006	Two 14mm Bushing provided in 1302033 bushing set
2007-2008	One 14mm / One 16mm bushing
2009-2012	Two 16mm Bushings (1302058)

Required Tools

- 18mm Socket/Wrench
- 2 1/16" Open End Wrench and/or Large Crescent Wrench
- Large Crescent (>1.5")
- Torque Wrench (>200 lbs-ft)

BD Engine Brake Inc.

Plant Address: 33541 MacLure Rd. Abbotsford, BC, Canada V2S 7W2

U.S. Shipping Address: 88-446 Harrison St, Sumas, WA 98295 U.S. Mailing Address: P.O. Box 231, Sumas, WA 98295

Phone: 604-853-6096 | Fax: 604-853-8749 | Internet: www.bd-power.com

INSTALLATION



VEHICLE SHOULD BE SAFELY SECURED BEFORE INSTALLATION.

THIS TRACK BAR SHOULD BE INSTALLED AT A SHOP THAT CAN PERFORM A FRONT END ALIGNMENT

Lift and support front of truck. Be sure to block the wheels to prevent the vehicle from rolling.

When lifting the truck keep the suspension under tension.



Using an 18mm socket remove the driver's side track bar bolt. You will reuse this bolt for re-installation.

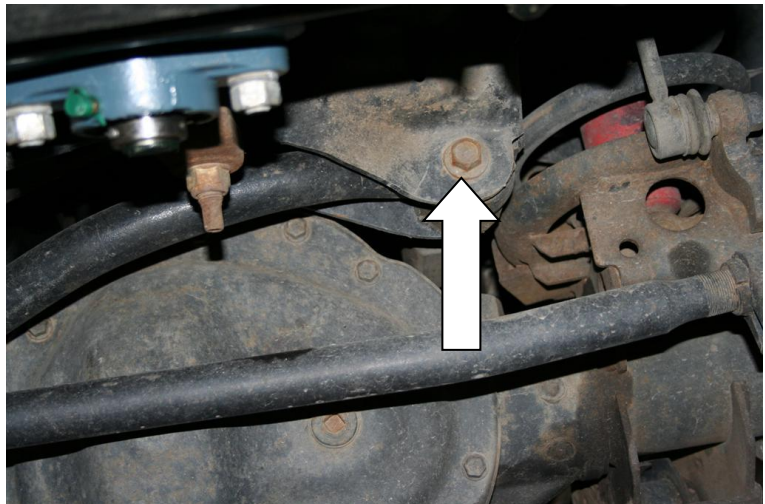
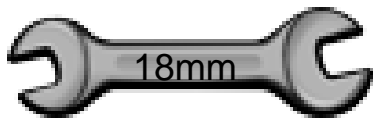

BD Engine Brake Inc.

Plant Address: 33541 MacLure Rd. Abbotsford, BC, Canada V2S 7W2

U.S. Shipping Address: 88-446 Harrison St, Sumas, WA 98295 U.S. Mailing Address: P.O. Box 231, Sumas, WA 98295

Phone: 604-853-6096 | Fax: 604-853-8749 | Internet: www.bd-power.com

Using the 18mm socket remove the passenger side track bar bolt. Again you will re-use for re-installation.

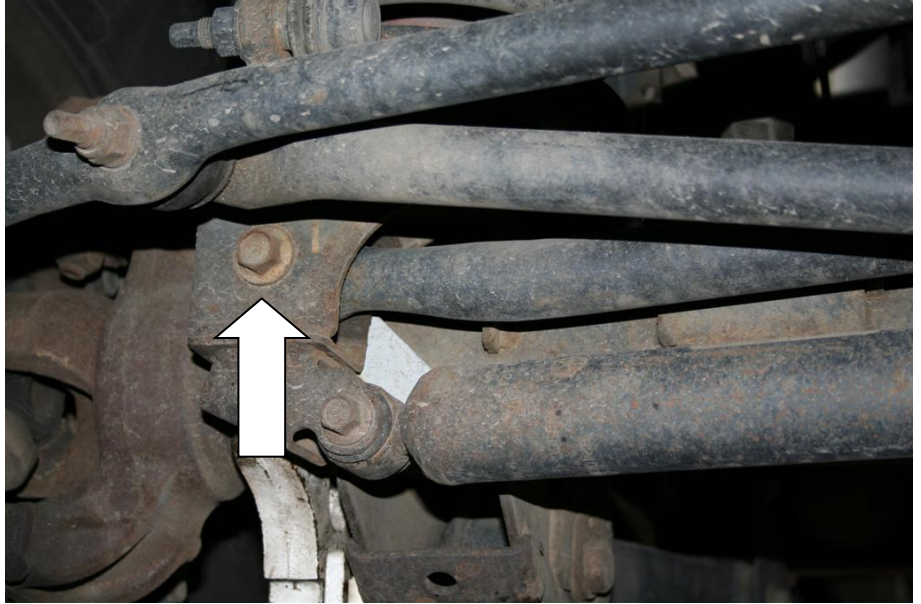
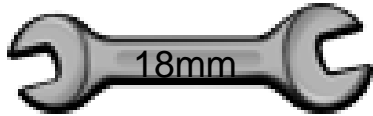

With the factory track bar removed, use a tape measure and measure the length of the factory track bar from the center of the bushing to the center of the bushing.



BD Engine Brake Inc.

Plant Address: 33541 MacLure Rd. Abbotsford, BC, Canada V2S 7W2

U.S. Shipping Address: 88-446 Harrison St, Sumas, WA 98295 U.S. Mailing Address: P.O. Box 231, Sumas, WA 98295

Phone: 604-853-6096 | Fax: 604-853-8749 | Internet: www.bd-power.com

Please check your factory bolts first as some 2008 vehicles use a 16mm bolt to secure the track bar and some 2009 use two.

Open the bag of poly bushings (#1302033). With the supplied grease rub it all around each half of the bushing (ID and OD).

Once fully lubed press the each half of the bushing into the track bar ends. Finally lube the steel sleeve and press into the bushings.

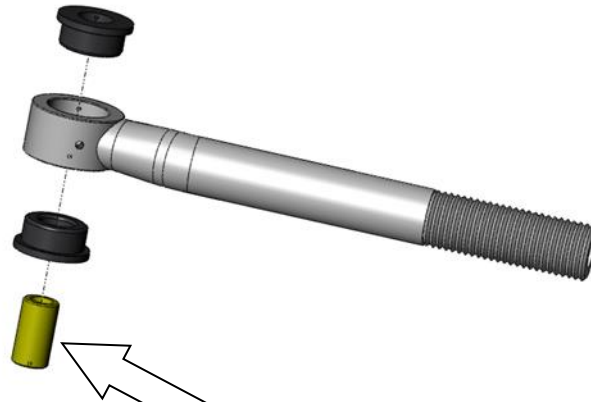

Check your factory bolts before inserting 14mm or 16mm DOM Sleeve

Please check your factory bolts first as some 2008 vehicles use a 16mm bolt to secure the track bar and some 2009 use two.

Use the remainder of the supplied grease and rub it all around each half of the bushing (ID and OD).

Once fully lubed press the each half of the bushing into the track bar ends. Finally lube the steel sleeve and press into the bushings.

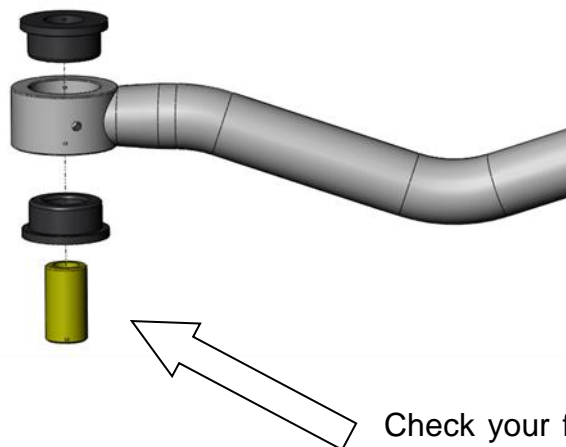

Check your factory bolts before inserting 14mm or 16mm DOM Sleeve

BD Engine Brake Inc.

Plant Address: 33541 MacLure Rd. Abbotsford, BC, Canada V2S 7W2

U.S. Shipping Address: 88-446 Harrison St, Sumas, WA 98295 U.S. Mailing Address: P.O. Box 231, Sumas, WA 98295

Phone: 604-853-6096 | Fax: 604-853-8749 | Internet: www.bd-power.com

Install the Left Hand Threaded Jam nut (#1302032) on the passenger side track bar section. You will need to thread this all the way to the end.

The Left Hand Thread nut will have an arrow on the side face.

Install a small amount of anti seize on the threads before threading the nut in place.

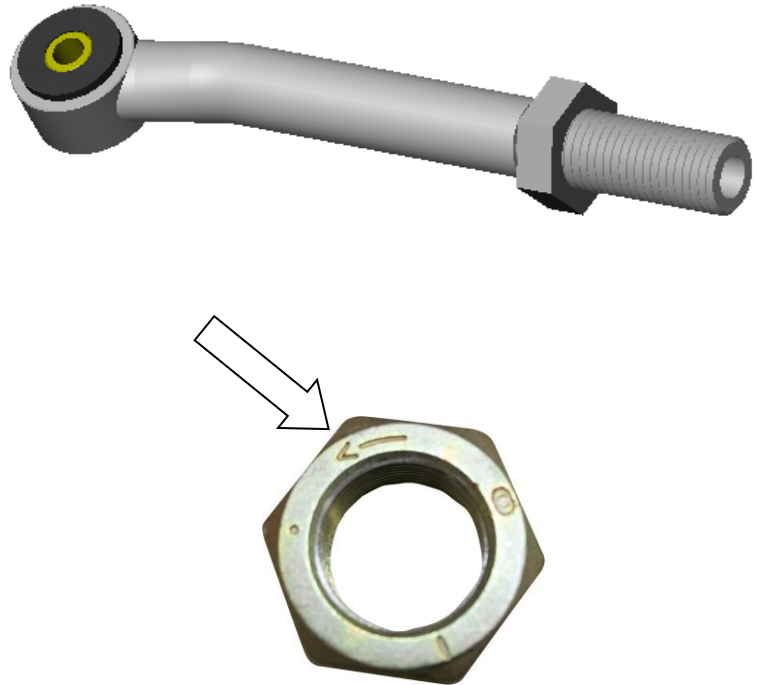

Install the Right Hand Threaded Jam nut (#1302031) on the driver's side track bar section. You will need to thread this all the way to the end.

Install a small amount of anti seize on the threads before threading the nut in place.



Thread the passenger side track bar section into the threaded connector
(1302030-4).

The passenger side track bar is Left Hand threaded, so you will need to mate these threads to the left hand thread of the connector. The left handed threads should be identified with an "LH".



Thread the driver's side section of the track bar into the threaded connector.

Measure from center of bushing to center of bushing and adjust the length to the original length of your factory track bar.

Make sure there is an equal number for threads show on each side of the threaded connector.

For example only, if you have $\frac{1}{2}$ " of thread showing on the passenger side of the threaded connector you should also have $\frac{1}{2}$ " showing on the driver's side of the threaded connector.



BD Engine Brake Inc.

Plant Address: 33541 MacLure Rd. Abbotsford, BC, Canada V2S 7W2

U.S. Shipping Address: 88-446 Harrison St, Sumas, WA 98295 U.S. Mailing Address: P.O. Box 231, Sumas, WA 98295

Phone: 604-853-6096 | Fax: 604-853-8749 | Internet: www.bd-power.com



DO NOT EXPOSE MORE THAN 2" OF THREAD FROM EITHER SIDE OF THE THREADED CONNECTOR.

Now you can install the track bar into the truck. Keep in mind that you will need to reuse the factory hardware. Tighten bolts to 150 ft lbs of torque.

Please note that 2008 vehicles may use a 16mm bolt, while 2009 vehicles will use two 16mm bolts.

Tighten 16mm bolts to 220 ftlbs.

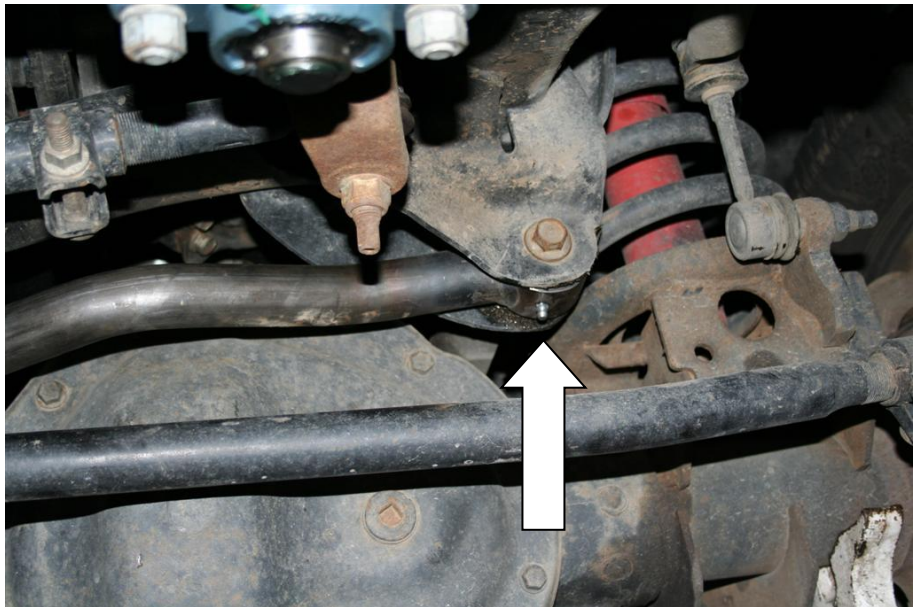

BD Engine Brake Inc.

Plant Address: 33541 MacLure Rd. Abbotsford, BC, Canada V2S 7W2

U.S. Shipping Address: 88-446 Harrison St, Sumas, WA 98295 U.S. Mailing Address: P.O. Box 231, Sumas, WA 98295

Phone: 604-853-6096 | Fax: 604-853-8749 | Internet: www.bd-power.com

You can now perform an alignment on the front end of the vehicle. Adjust the front axle left and right by turning the threaded connector.

The shorter you make the track bar the more it will pull the front axle towards the driver's side. And vice versa.

Once the alignment is complete tighten the jam nuts to approximately 225 ft lbs of torque.



DO NOT DRIVE THE VEHICLE WITHOUT COMPLETING A PROPER ALIGNMENT.

If you have any technical difficulties, concerns, comments, or complaints, please phone our Technical Support hotline at (800) 887-5030 between 8:30am-5:00pm PST (Pacific Standard Time) Monday to Friday.

BD Engine Brake Inc.

Plant Address: 33541 MacLure Rd. Abbotsford, BC, Canada V2S 7W2

U.S. Shipping Address: 88-446 Harrison St, Sumas, WA 98295 U.S. Mailing Address: P.O. Box 231, Sumas, WA 98295

Phone: 604-853-6096 | Fax: 604-853-8749 | Internet: www.bd-power.com